

EN_IMPORTANT, RETAIN FOR FUTURE REFERENCE: READ CAREFULLY.

FR_IMPORTANT: A LIRE ATTENTIVEMENT ET À CONSERVER POUR CONSULTATION ULTÉRIEURE.

ES_IMPORTANTE, LEA Y GUARDE PARA FUTURAS REFERENCIAS.

DE_, WICHTIG! SORGFÄLTIG LESEN UND FÜR SPÄTER NACHSCHLAGEN AUFBEWAHREN."

IT_IMPORTANTE! CONSERVARE IL PRESENTE MANUALE PER FUTURO RIFERIMENTO E LEGGERLO ATTENTAMENTE.

EN

Dear customer,

Thank you for purchasing this product. So that your appliance serves you well, please read all the instructions in this user's manual. If you have any questions, please contact our customer care center.

FR

Cher client,

Nous vous remercions d'avoir acheté ce produit. Afin que vous puissiez profiter pleinement de votre appareil, veuillez lire toutes les instructions de ce manuel d'utilisation. Si vous avez la moindre question, veuillez contacter notre centre d'assistance à la clientèle.

DE

Sehr geehrter Kunde,

Vielen Dank, dass Sie dieses Produkt erworben haben. Damit Ihr Gerät Ihnen gute Dienste leistet, lesen Sie bitte alle Hinweise in diesem Benutzerhandbuch. Wenn Sie Fragen haben, wenden Sie sich bitte an unser Kundendienstzentrum.

ES

Queridos clientes,

Gracias por comprar este producto. Para que su electrodoméstico le sirva mejor, lea todas las instrucciones de este manual del usuario. Si tiene alguna pregunta, comuníquese con nuestro Centro de Atención al Cliente.

PT

Caros clientes,

Obrigado por adquirir este produto. Para que o seu aparelho o sirva melhor, leia todas as instruções deste manual do utilizador. Se tiver alguma dúvida, por favor contacte o nosso Centro de Atendimento ao Cliente.

IT

Caro Cliente,

Grazie per aver acquistato questo prodotto. Per servirti meglio con questo apparecchio ti prego di leggere tutte le istruzioni in presente manuale utente. In caso di dubbio, si prega di contattare il nostro centro assistenza clienti.

EN_Our contact details are below:



FR_Nos coordonnées sont les suivantes:

DE_Unsere Kontaktdaten stehen unten:

ES_Nuestros datos de contacto son los siguientes:

PT_Os nossos dados de contacto são os seguintes:

IT_I nostri dettagli di contatto sono di seguito:

Country	 Phone	 Email
UK	0044-800-240-4004	enquiries@mhstar.co.uk
DE	0049-0(40)-88307530	service@aosom.de
FR	0033-1-84166106	aosom@mhfrance.fr
ES&PT	0034-931294512	atencioncliente@aosom.es
IT	0039-0249471447	clienti@aosom.it

CAUTION

For indoor use only.

Keep out of reach of children and animals.

Do not use in the bathroom or damp places.

Place the lamp on a flat surface and ensure it is placed away from any flammable materials.

Before cleaning the lamp, ensure it is switched off.

Before replacing the bulb, ensure the plug has been removed from the socket and the lamp has cooled down.

Do not pull the plug out of the socket with wet hands.

If the supply cord is damaged it must only be replaced by a qualified engineer.

MISE EN GARDE

Destinée pour une utilisation a l'intérieur.

Tenir hors de portée des enfants et des animaux.

Ne pas utiliser dans la salle de bains ou dans des endroits humides.

Placez la lampe sur une surface propre et assurez-vous qu'elle soit placée à l'écart de toute matière inflammable.

Avant de nettoyer la lampe, assurez-vous qu'elle soit éteinte .

Avant de remplacer l'ampoule, vérifier que le bouchon ait été retiré de la sortie et que la lampe se soit refroidie.

Ne tirez pas la prise avec les mains mouillées.

Si le cordon est endommagé, il doit être remplacé par un technicien qualifié.

ATTENZIONE

Solo per uso interno.

Tenere fuori dalla portata dei bambini e degli animali.

Non utilizzare in bagno o in luoghi umidi.

Posizionare la lampada su una superficie piana e accertarsi che sia posizionata lontano da qualsiasi materiale infiammabile.

Prima di pulire la lampada, assicurarsi che sia spenta.

Prima di sostituire la lampadina, assicurarsi che la spina sia stata rimossa dalla presa e che la lampada si sia raffreddata.

Non tirare la spina dalla presa con le mani bagnate.

Se il cavo di alimentazione è danneggiato, deve essere sostituito da un tecnico qualificato.

Vorsicht:

Nur für den Innengebrauch bestimmt.

Halten Sie die Lampe aus der Reichweite von Kindern und Tieren.

Stellen Sie die Lampe nicht im Badezimmer oder an feuchten Orten auf.

Stellen Sie die Lampe auf flachen Oberflächen und nicht in der Nähe von entzündlichen Materialien auf.

Bevor Sie die Lampe reinigen, stellen Sie sicher, dass diese ausgeschaltet wurde.

Stellen Sie vor dem Glühbirnenwechsel sicher, dass die Lampe von der Stromversorgung getrennt wurde und die Glühbirne abgekühlt ist.

Ziehen Sie nicht am Stecker mit nassen Händen.

Wenn das Stromversorgungskabel beschädigt wurde, darf es nur durch einen qualifizierten Elektriker gewechselt werden.

PRECAUCIÓN

Sólo para uso en interiores.

Mantener fuera del alcance de los niños y animales.

No lo use en el baño o en lugares húmedos.

Coloque la lámpara sobre una superficie limpia y asegúrese de que está colocada lejos de cualquier material inflamable.

Antes de limpiar la lámpara, asegúrese de que esté apagada.

Antes de reemplazar la bombilla, asegúrese de que el enchufe ha sido retirado de la toma y la lámpara se ha enfriado.

No tire del enchufe con las manos mojadas.

Si el cable de alimentación está dañado, sólo debe ser reemplazado por un ingeniero cualificado.

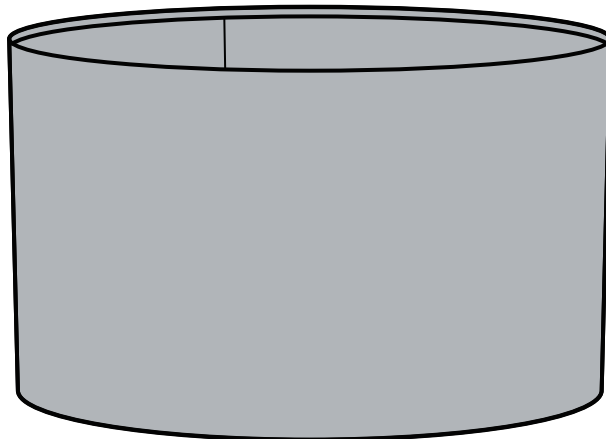
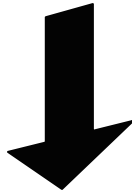
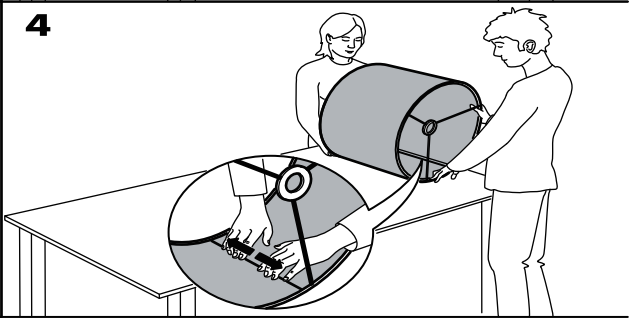
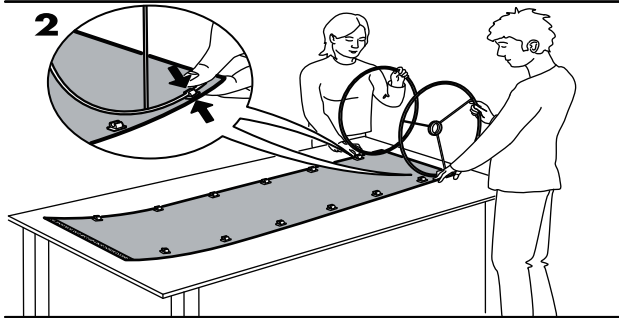
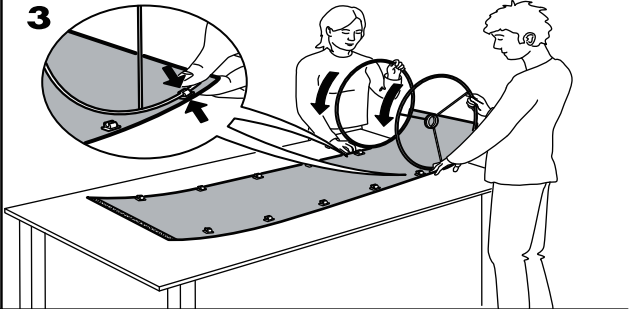
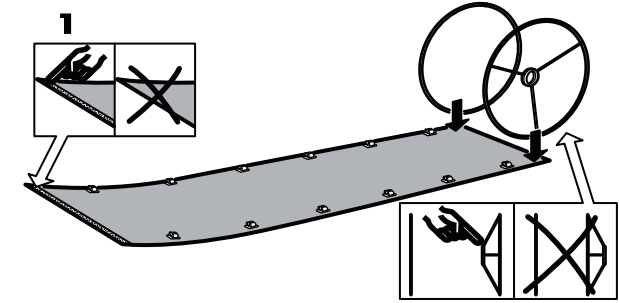
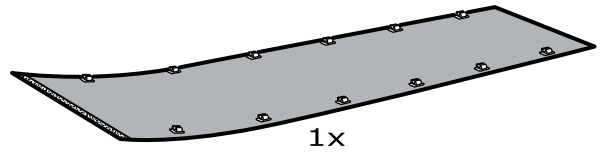
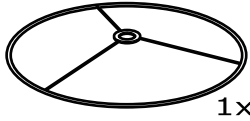
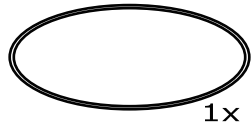

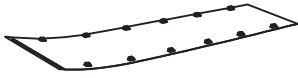
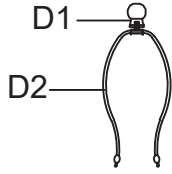
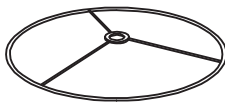
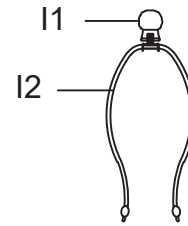
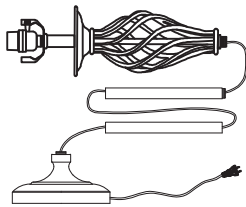
A x 2**B** x 2**C** x 2**D** x 2**E** x 2**F** x 1**G** x 1**H** x 1**I** x 1**J** x 1

01

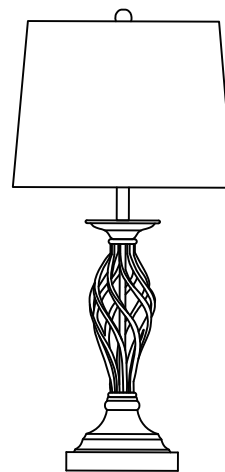
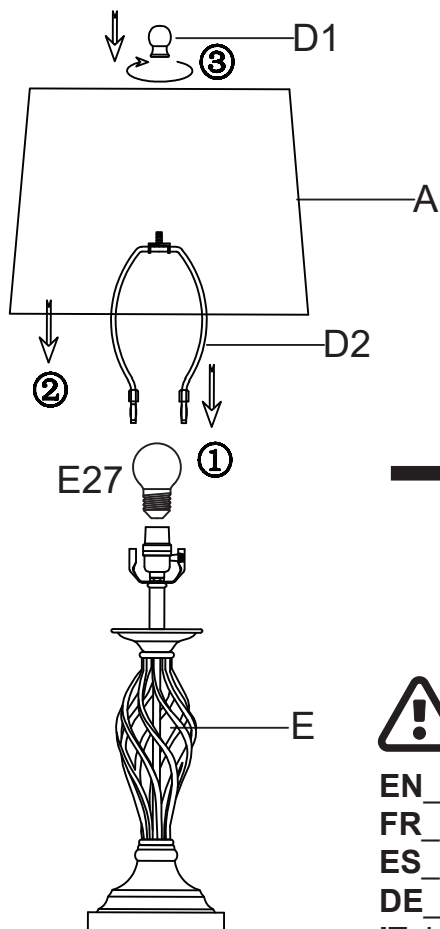

EN_ The bulb is not included.

FR_ L'ampoule n'est pas incluse.

ES_ La bombilla no está incluida.

DE_ Die Glühbirne ist nicht im Lieferumfang enthalten.

IT_ La lampadina non è inclusa.

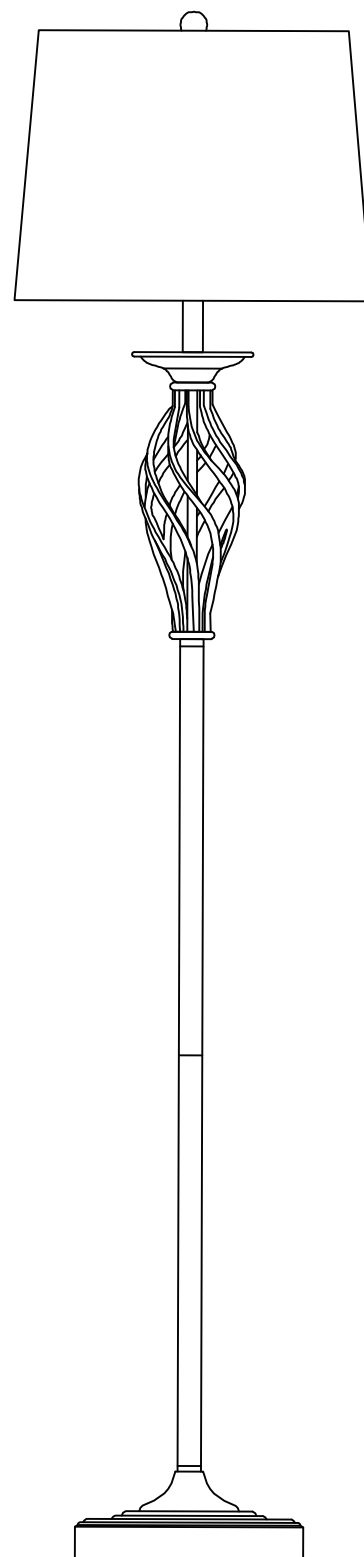
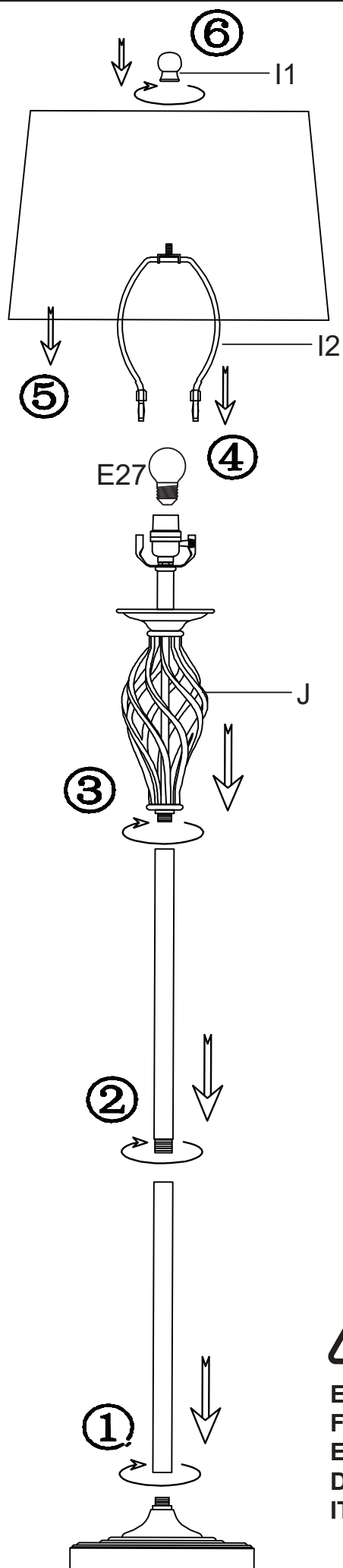

EN_ The bulb is not included.
 FR_ L'ampoule n'est pas incluse.
 ES_ La bombilla no está incluida.
 DE_ Die Glühbirne ist nicht im Lieferumfang enthalten.
 IT_ La lampadina non è inclusa.

IMPORTER ADDRESS**EN**

MH STAR UK LTD
Unit 27, Perivale Park,
Horsenden lane South
Perivale, UB6 7RH
MADE IN CHINA

ADRESSE D'IMPORTATION**FR**

MH FRANCE
2 Rue Maurice Hartmann
92130 Issy Les Moulineaux
France
FABRIQUÉ EN CHINE

IMPORTADOR**ES**

SPANISH AOSOM, S.L.
C/ ROC GROS, Nº 15. 08550, ELS HOSTALET DE BALENYÀ, SPAIN.
B66295775
WWW.AOSOM.ES
ATENCIONCLIENTE@AOSOM.ES
TEL: 931294512
HECHO EN CHINA

ADRESSE DES IMPORTEUR**DE**

MH Handel GmbH
Wendenstraße 309
D-20537 Hamburg
Germany
IN CHINA HERGESTELLT

IMPORTATO DA**IT**

AOSOM Italy srl
Centro Direzionale Milanofiori
Strada 1 Palazzo F1
20057 Assago (MI)
P.I.: 08567220960
FATTO IN CINA