

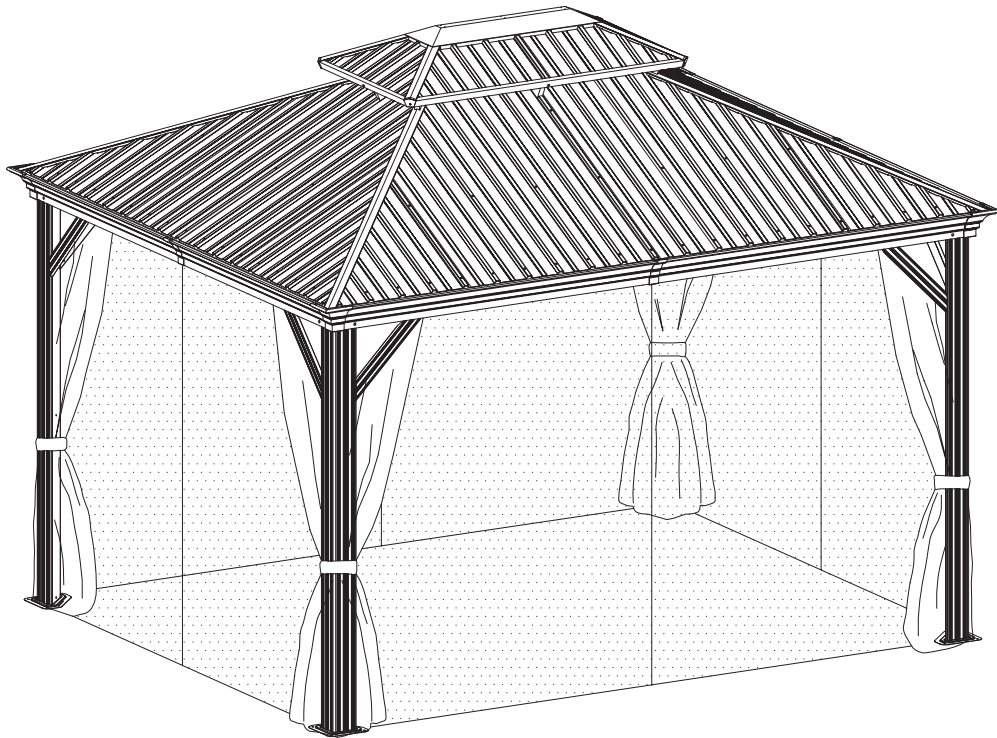

IN220800193V01\_GL

**84C-204\_84C-204V02CG**



*EN*\_Assembly video please scan the QR code.

*FR*\_Vidéo d'assemblage, veuillez scanner le code QR.

*ES*\_Montagevideo scannen Sie bitte den QR-Code ein.

*PT*\_Vídeo de montagem por favor digitalizar o código QR.

*DE*\_Vídeo de montaje, escanea el código QR.

*IT*\_Scansionare il codice QR per il Video di Assemblaggio

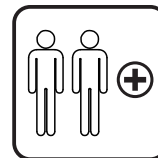
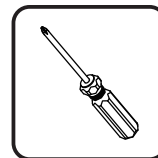
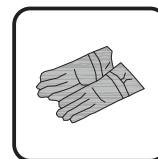
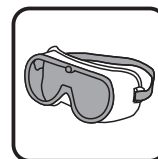
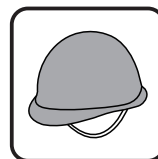
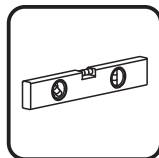
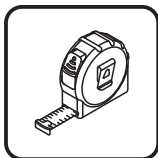
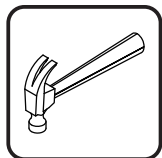

Tools Recommended

***EN*\_IMPORTANT, RETAIN FOR FUTURE REFERENCE: READ CAREFULLY.**

***FR*\_IMPORTANT: A LIRE ATTENTIVEMENT ET À CONSERVER POUR CONSULTATION ULTÉRIEURE.**

***ES*\_IMPORTANTE, LEA Y GUARDE PARA FUTURAS REFERENCIAS.**

***PT*\_IMPORTANTE, RETER PARA REFERÊNCIA FUTURA: LEIA ATENTAMENTE.**

***DE*\_WICHTIG! SORGFÄLTIG LESEN UND FÜR SPÄTER NACHSCHLAGEN AUFBEWAHREN.**

***IT*\_IMPORTANTE! CONSERVARE IL PRESENTE MANUALE PER FUTURO RIFERIMENTO E LEGGERLO ATTENTAMENTE.**

EN

**Dear customer,**

Thank you for purchasing this product. So that your appliance serves you well, please read all the instructions in this user's manual. If you have any questions, please contact our customer care center, Our contact details are below:

FR

**Cher client,**

Nous vous remercions d'avoir acheté ce produit. Afin que vous puissiez profiter pleinement de votre appareil, veuillez lire toutes les instructions de ce manuel d'utilisation. Si vous avez la moindre question, veuillez contacter notre centre d'assistance à la clientèle, Nos coordonnées sont les suivantes:

DE

**Sehr geehrter Kunde,**

Vielen Dank, dass Sie dieses Produkt erworben haben. Damit Ihr Gerät Ihnen gute Dienste leistet, lesen Sie bitte alle Hinweise in diesem Benutzerhandbuch. Wenn Sie Fragen haben, wenden Sie sich bitte an unser Kundendienstzentrum, Unsere Kontaktdaten stehen unten:

ES

**Queridos clientes,**

Gracias por comprar este producto. Para que su electrodoméstico le sirva mejor, lea todas las instrucciones de este manual del usuario. Si tiene alguna pregunta, comuníquese con nuestro Centro de Atención al Cliente, Nuestros datos de contacto son los siguientes:

PT

**Caros clientes,**

















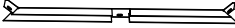









Obrigado por adquirir este produto. Para que o seu aparelho o sirva melhor, leia todas as instruções deste manual do utilizador. Se tiver alguma dúvida, por favor contacte o nosso Centro de Atendimento ao Cliente, Os nossos dados de contacto são os seguintes:



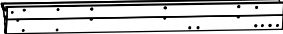
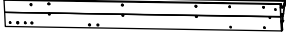
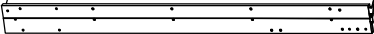





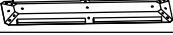









IT

**Caro Cliente,**

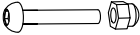
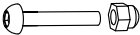

Grazie per aver acquistato questo prodotto. Per servirti meglio con questo apparecchio ti prego di leggere tutte le istruzioni in presente manuale utente. In caso di dubbio, si prega di contattare il nostro centro assistenza clienti, I nostri dettagli di contatto sono di seguito:

Country	 Phone	 Email
US	001-877-644-9366	customerservice@aosom.com
CA	416-792-6088	customerservice@aosom.ca
UK	0044-800-240-4004	enquiries@mhstar.co.uk
DE	0049-0(40)-88307530	service@aosom.de
FR	0033-1-84166106	aosom@mhfrance.fr
ES&PT	0034-931294512	atencioncliente@aosom.es
IT	0039-0249471447	clienti@aosom.it

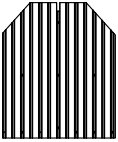
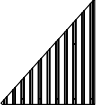
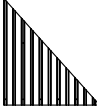
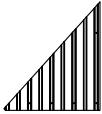
Carton-1/3	No	Reference Picture	Part	Qty
	1		A	4
	2		C1	4
	3		C2	4
	4		D1	4
	5		D2	4
	6		E1	4
	7		F1	2
	8		F3	2
	9		H	4
	10		I	4
	11		O1	2
	12		O2	2
	13		O3	2
	14		O4	2
	15		P1	2
	16		P2	2
	17		P3	2
	18		P4	2
	19		T1	4
	20		V	98
	21		Z1	56
	22		Z2	16
	Carton-2/3	No	Reference Picture	Part
1			B1	2
2			B2	2
3			B3	2
4			B4	2
5			E2	4
6			F2	2
7			F4	2
8			G1	4
9			G2	4
10		J1	1	

Carton-2/3		No	Reference Picture	Part	Qty
		11		J2	1
		12		K1	8
		13		K2	4
		14		L	4
		15		M1	4
		16		M2	4
		17		T2	4
		18		T3	1
		19		U	108
		20		W	12
		21	 M6x15	1	235
		22	 M5x12	3	4
		23	 ST4.8x12	4	26
		24		5	2
		25	 M6x60	6	12
		26	 x 5  x 67    M6x23	7	72
		27	 M6x42	8	9
		28	 M6x47	9	22
		29		10	9
		30			4
Carton-3/3		No	Reference Picture	Part	Qty
		1		Q	2
		2		Q1	2
		3		Q2	2
		4		R1	2

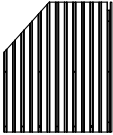
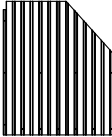
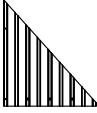
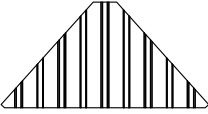

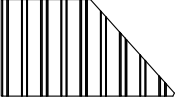
Carton-3/3	No	Reference Picture	Part	Qty
	5		R2	2
	6		R3	2
	7		R4	2
	8		S1	2
	9		S2	2
	10		S3	2

**EN**

### **IMPORTANT SAFETY NOTICE**

Product is NOT INTENDED for the following:

- A safety barrier to prevent unsupervised access to pools, hot tubs, spas or ponds.
- As load bearing support for a building, structure, heavy objects or swings.
- Used in structures that trap wind, rain or snow that would create extra load on the product.

Accumulated snow must be removed from roof.

DO NOT climb or walk on roof for any reason.

Wear gloves to avoid injury from possible sharp edges of individual elements before assembly.

During installation, follow all safety warnings provided with your tools.

Some structures may require two or more people to install safely.

Check for underground utilities before digging or driving stakes into the ground!

It is important during assembly to closely follow the instructions, complete the assembly on a solid level surface and that you follow the instruction to square up, level and anchor the structure, this will reduce the gap at connections during assembly.

**FR**

### **AVIS IMPORTANT DE SÉCURITÉ**

Le produit n'est PAS DESTINÉ à ce qui suit :

- Une barrière de sécurité pour empêcher l'accès non surveillé aux piscines, aux spas, aux cuves thermales ou aux étangs.
- Comme support de charge pour un bâtiment, une structure, des objets lourds ou des balançoires.
- Utilisé dans des structures qui retiennent le vent, la pluie ou la neige qui créeraient une charge supplémentaire sur le produit.

La neige accumulée doit être enlevée du toit.

NE PAS grimper ou marcher sur le toit pour quelque raison que ce soit.

Portez des gants pour éviter les blessures causées par d'éventuels bords tranchants des composants avant de procéder à l'assemblage.

Lors de l'installation, respectez tous les avertissements de sécurité fournis avec vos outils.

Certaines structures peuvent nécessiter l'intervention de deux personnes ou plus pour les installer en toute sécurité.

Vérifiez la présence de services publics souterrains avant de creuser ou de planter des piquets dans le sol !

Il est important, pendant tout le processus de montage, de suivre attentivement les instructions, de terminer l'assemblage sur une surface solide et plane et de suivre les instructions d'équerrage, de mise à niveau et d'ancrage de la structure, ce qui permettra de réduire les écarts au niveau des liaisons pendant le montage.

**ES**

### **AVISO IMPORTANTE DE SEGURIDAD**

Manténgase alejado de las líneas eléctricas aéreas.

No coloque ni instale su tienda de campaña debajo de los árboles debido a posibles rayos o hundimiento de las ramas de los árboles en condiciones climáticas adversas. Para obtener las mejores condiciones en caso de viento fuerte, coloque el extremo estrecho de la tienda en la dirección del viento.

No dejes caer la tienda de campaña.

No haga rebotar ni golpee la bolsa de la tienda para sacarla, estas acciones podrían dañar el marco.

### **ESTE PRODUCTO REQUIERE UN MÍNIMO DE DOS PERSONAS PARA SU MONTAJE**

Bajo ninguna circunstancia se debe utilizar este producto para cubrir automóviles, vehículos marinos o artículos similares.

**PRECAUCIÓN:** Vigile no pellizcarse los dedos durante el montaje y desmontaje de la tienda al unir las piezas del marco.

**WICHTIGER SICHERHEITSHINWEIS**

Das Produkt ist NICHT für einen der folgenden Anwendungen bestimmt:

- Als Sicherheitsbarriere, die den unbeaufsichtigten Zugang zu Pools, Whirlpools, Spas oder Teichen verhindert.
- Als tragende Stütze für ein Gebäude, eine Struktur, schwere Gegenstände oder Schaukeln.
- Als Bestandteil einer Struktur verwendet werden, welche Wind, Regen oder Schnee abfangen, die eine zusätzliche Belastung für das Produkt darstellen würden. Angesammelter Schnee muss vom Dach entfernt werden.

Aus keinem Grund darf das Dach bestiegen oder betreten werden.

Bitte tragen Sie stets geeignete Arbeitshandschuhe, um Verletzungen durch mögliche scharfe Kanten einzelner Elemente während der Montage zu vermeiden.

Befolgen Sie während des Installationsprozesses bitte sorgfältig alle Sicherheitswarnungen, die mit Ihren Werkzeugen geliefert werden.

Einige Strukturen können zwei oder mehr Personen erfordern, um sicher installiert zu werden.

Prüfen Sie vor dem Graben oder Eintreiben von Pfählen in den Boden, ob Erdkabel vorhanden sind!

Es ist wichtig, während der Montage die Anweisungen genau zu befolgen, Ihr Produkt auf einem festen und ebenen Untergrund aufzustellen und die Anweisung zum Aufrichten, Nivellieren und Verankern der Struktur zu befolgen, da dadurch der Spalt an den Verbindungen während der Montage verringert wird.

**IMPORTANTI PRECAUZIONI DI SICUREZZA**

Il prodotto NON è PROGETTATO per quanto segue:

- Una barriera di sicurezza per impedire l'accesso senza supervisione a piscine, vasche idromassaggio, spa o stagni.
- Supporto portante di edifici, strutture, oggetti pesanti o altalene.
- Parte di strutture che accumulano vento, pioggia o neve, in quanto creerebbero un carico extra sul prodotto.

La neve accumulata deve essere rimossa dal tetto.

NON salire o camminare sul tetto per nessun motivo.

Indossare guanti per evitare lesioni derivanti da spigoli vivi dei singoli componenti prima del montaggio.

Durante l'installazione, seguire tutte le precauzioni di sicurezza fornite con gli strumenti.

Alcune strutture possono richiedere due o più persone per essere installate in sicurezza.

Controlla le utenze sotterranee prima di scavare o piantare pali nel terreno!

È importante che durante il montaggio vengano seguite attentamente le istruzioni, inoltre completare il montaggio su una superficie piana e solida e seguire le istruzioni per allineare, livellare e ancorare la struttura, in quanto questo ridurrà lo spazio necessario durante il montaggio.

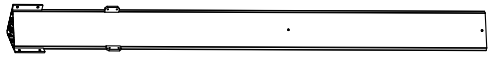

(A) x 4



(B1) x 2



(B2) x 2

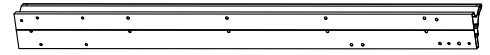

(B3) x 2

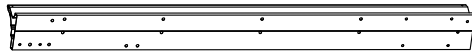

(B4) x 2

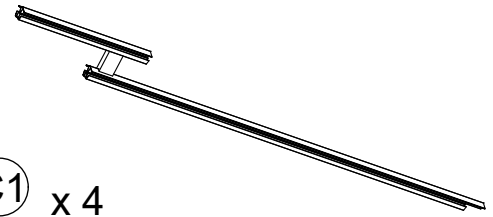

(C1) x 4

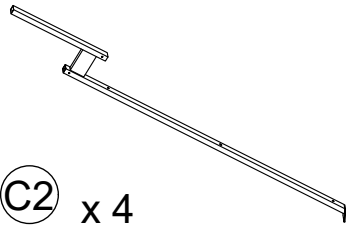

(C2) x 4



(D1) x 4



(D2) x 4



(E1) x 4



(E2) x 4



(F1) x 2



(F2) x 2

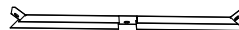

(F3) x 2



(F4) x 2



(O1) x 2



(O2) x 2



(O3) x 2



(O4) x 2







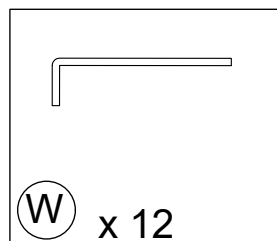
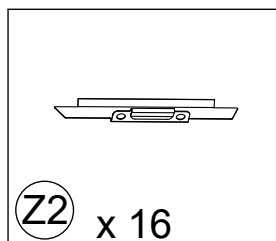
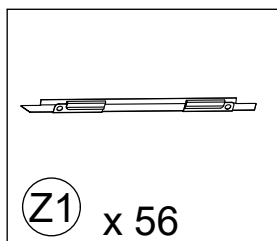
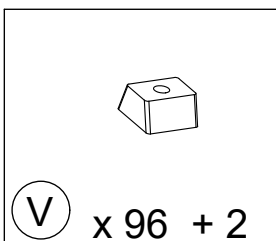
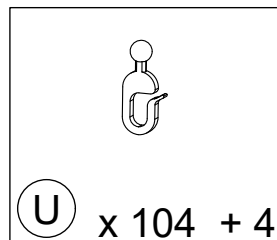
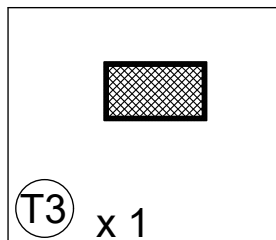
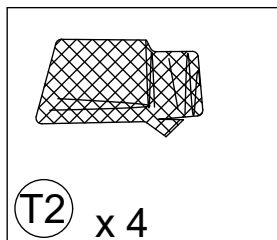
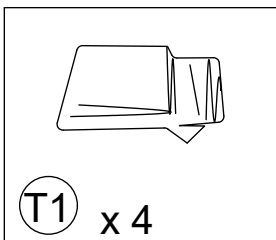
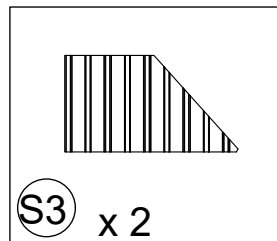
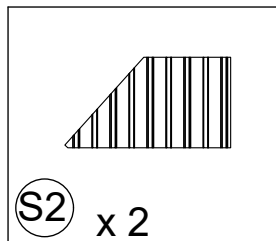
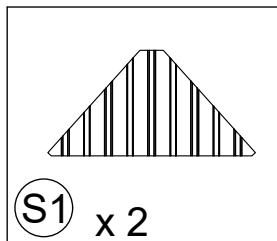
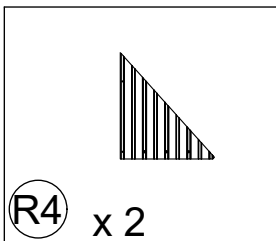
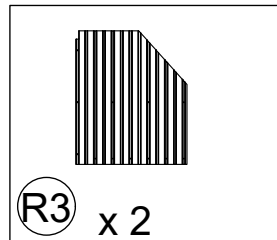
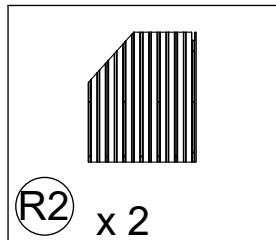
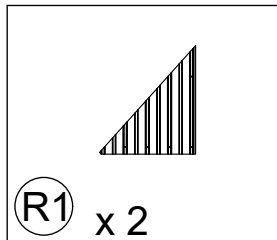
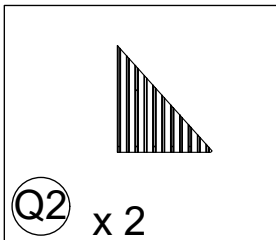
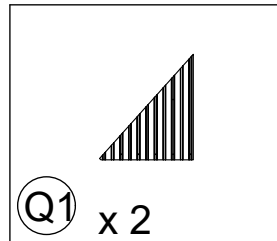
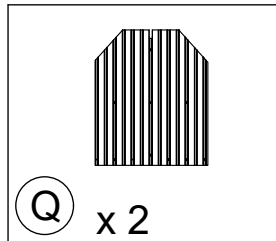
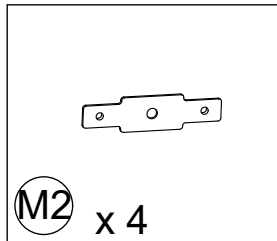
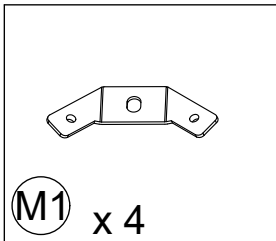
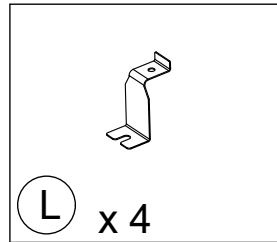
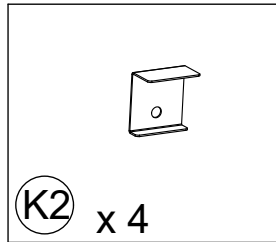
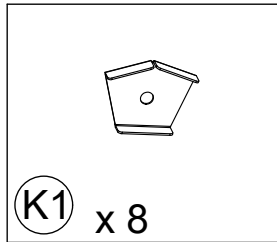
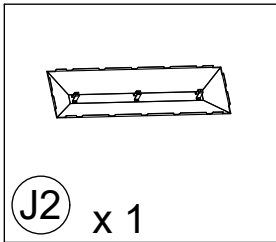
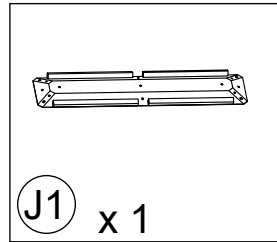
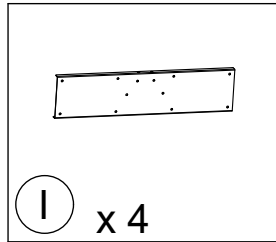
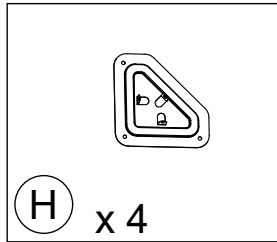
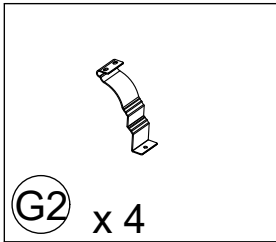
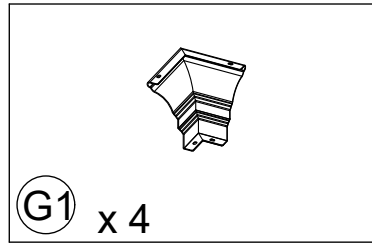
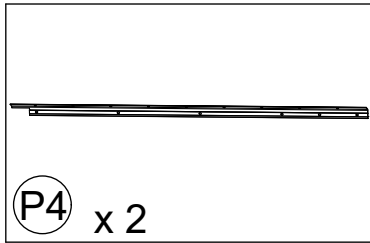
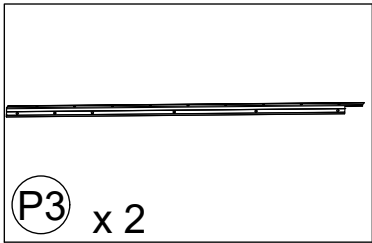

(P1) x 2



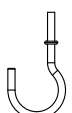

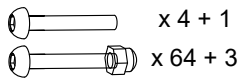
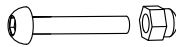
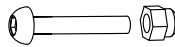
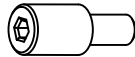
(P2) x 2

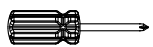
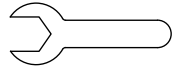





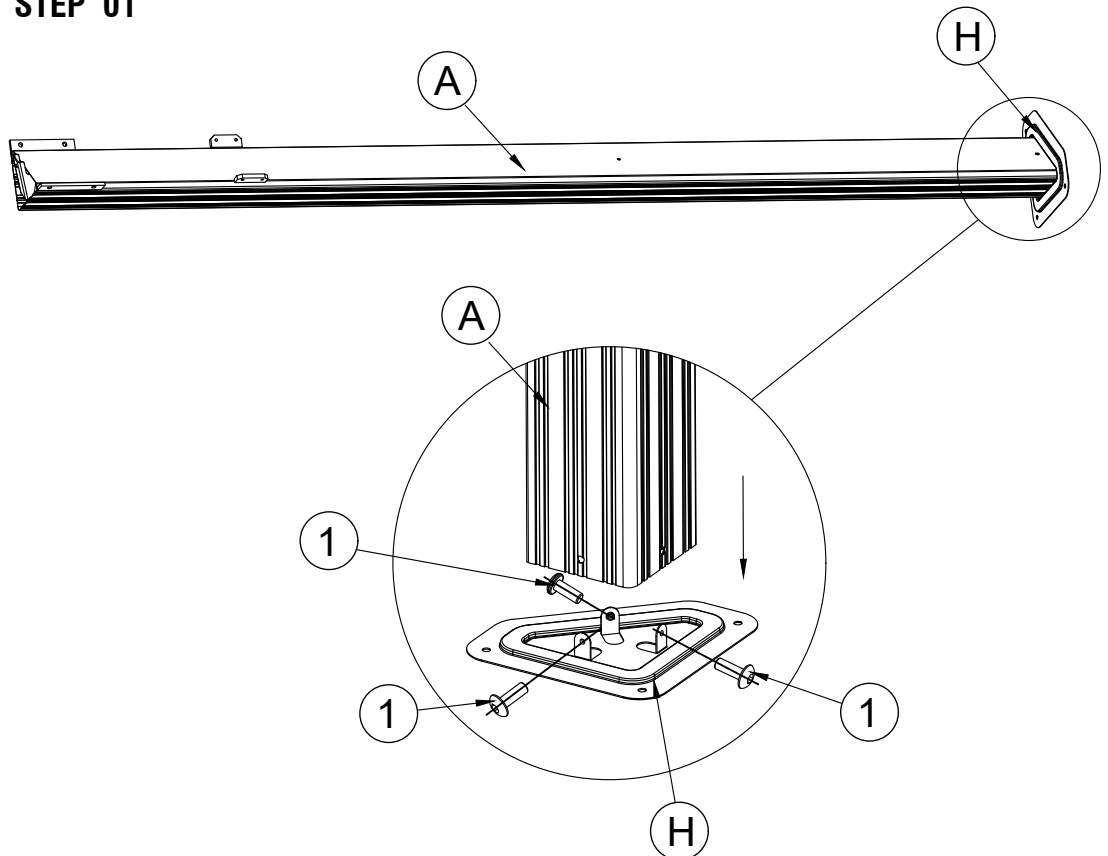

 <b>M6x15</b> <b>1</b> x 229 + 6	 <b>M5x12</b> <b>3</b> x 4 + 1	 <b>ST4.8x12</b> <b>4</b> x 24 + 2	 <b>5</b> x 2
 <b>M6x60</b> <b>6</b> x 12	 x 4 + 1 x 64 + 3 <b>M6x23</b> <b>7</b>	 <b>M6x42</b> <b>8</b> x 8 + 1	 <b>M6x47</b> <b>9</b> x 20 + 2
 <b>10</b> x 8 + 1			
 <b>x 2</b>	 <b>x 1</b>	 <b>x 1</b>	

**STEP 01**

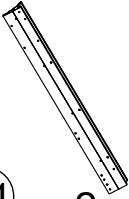
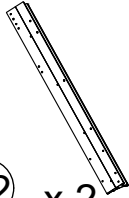
-   
**A** x 4
-   
**H** x 4
-   
**M6 x 15**  
**1** x 12

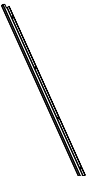

STEP 02

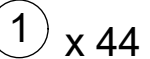

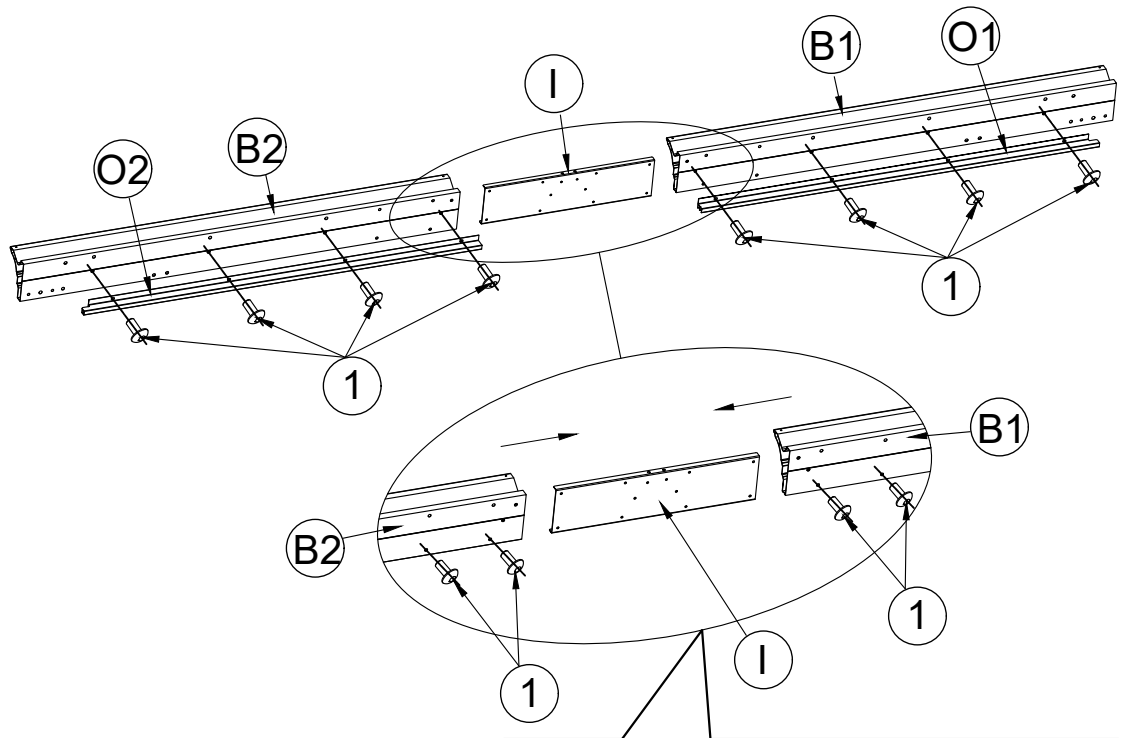

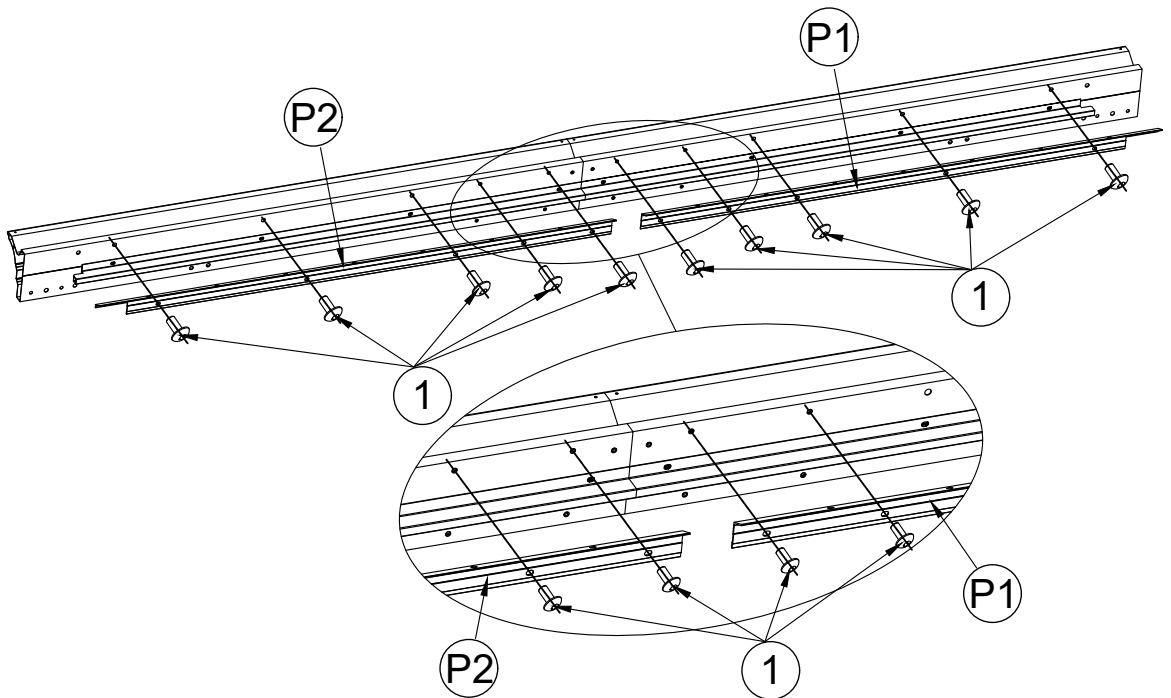

-  **B1** x 2
-  **B2** x 2
-  **O1** x 2
-  **O2** x 2
-  **P1** x 2
-  **P2** x 2
-  **I** x 2
-  **M6x15**
-  **1** x 44

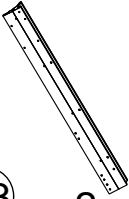
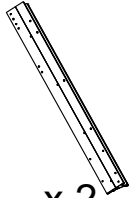

EN: This is divided into up and down directions, and the position of the hole refers to the enlarged view.  
 DE: Dies ist in Aufwärts- und Abwärtsrichtung unterteilt, und die Position des Lochs bezieht sich auf die vergrößerte Ansicht.  
 ES: Esto se divide en direcciones hacia arriba y hacia abajo, y la posición del orificio se refiere a la vista ampliada.  
 FR: Ceci est divisé en directions de haut en bas, et la position du trou se réfère à la vue agrandie.  
 IT: Questo è diviso in posizione verso il basso e verso l'alto, e la posizione del foro si riferisce alla visuale allargata.



**STEP 03**

-  **B3** x 2
-  x 2
-  **O3** x 2
-  **O4** x 2
-  **P3** x 2
-  **P4** x 2
- 
- I** x 2
-  **M6x15**
- 1** x 52

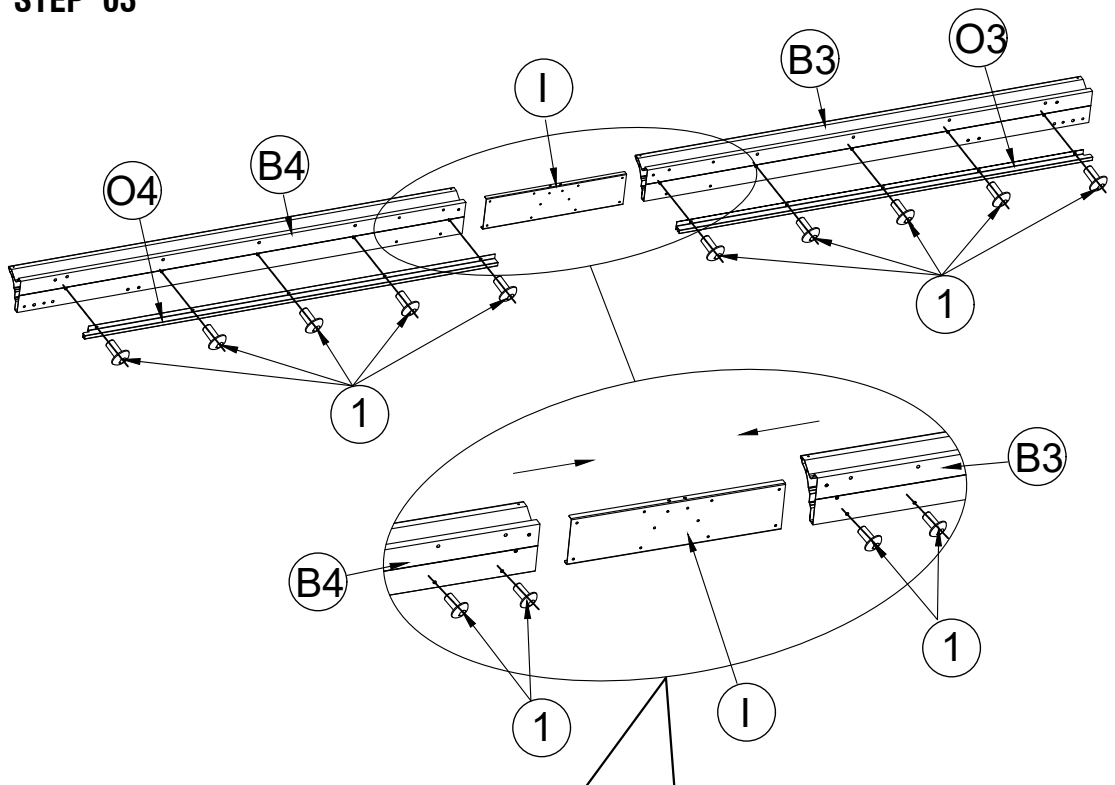

EN: This is divided into up and down directions, and the position of the hole refers to the enlarged view.  
 DE: Dies ist in Aufwärts- und Abwärtsrichtung unterteilt, und die Position des Lochs bezieht sich auf die vergrößerte Ansicht.  
 ES: Esto se divide en direcciones hacia arriba y hacia abajo, y la posición del orificio se refiere a la vista ampliada.  
 FR: Ceci est divisé en directions de haut en bas, et la position du trou se réfère à la vue agrandie.  
 IT: Questo è diviso in posizione verso il basso e verso l'alto, e la posizione del foro si riferisce alla visuale allargata.

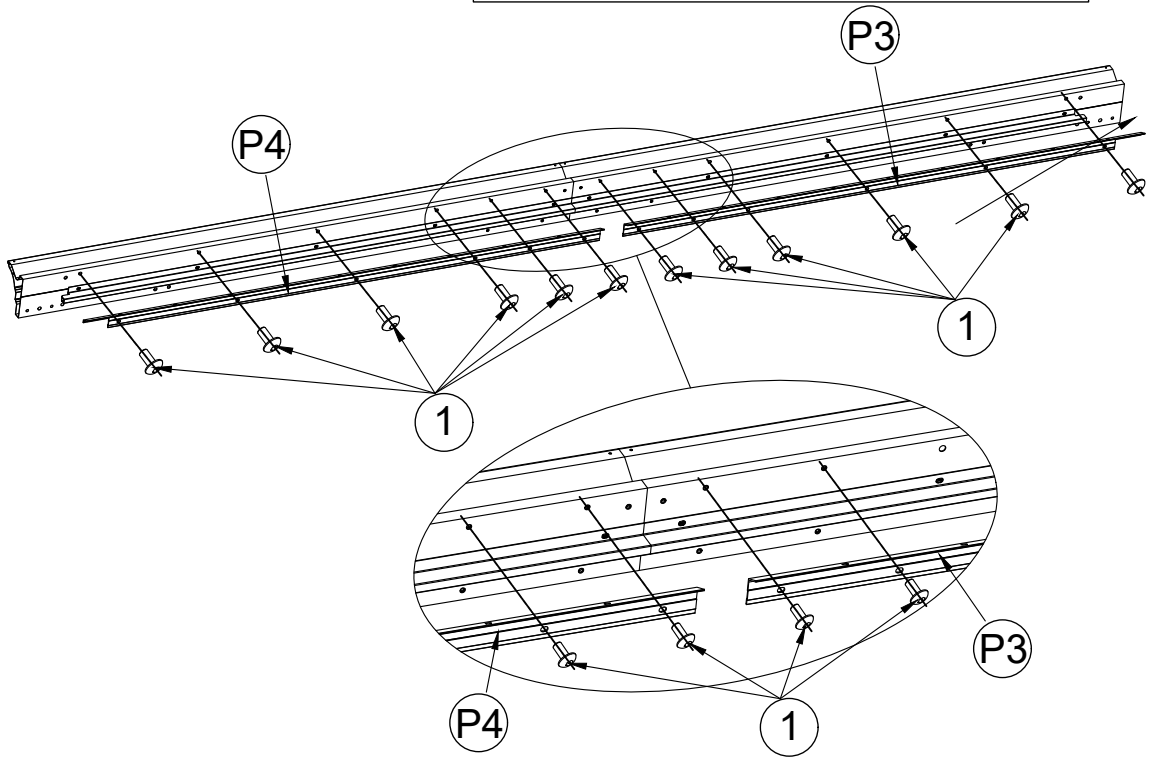



# STEP 04

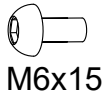

1 x 12

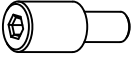

10 x 4

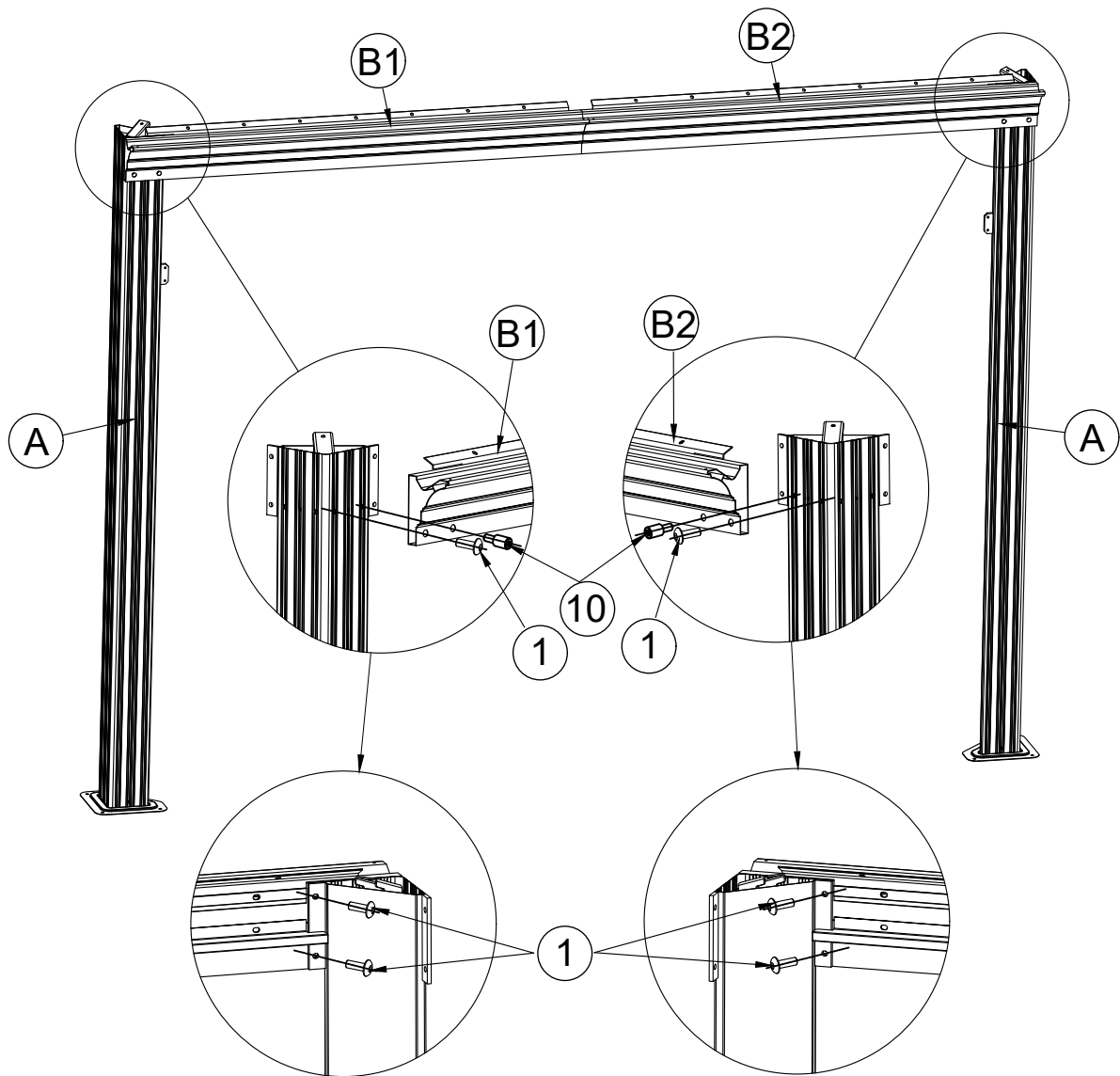

# STEP 05

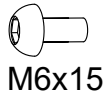

1 x 12

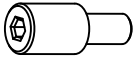

10 x 4

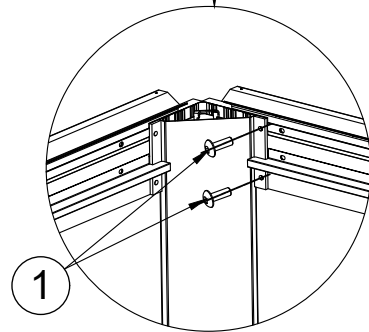
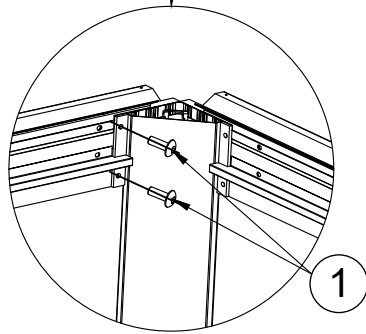
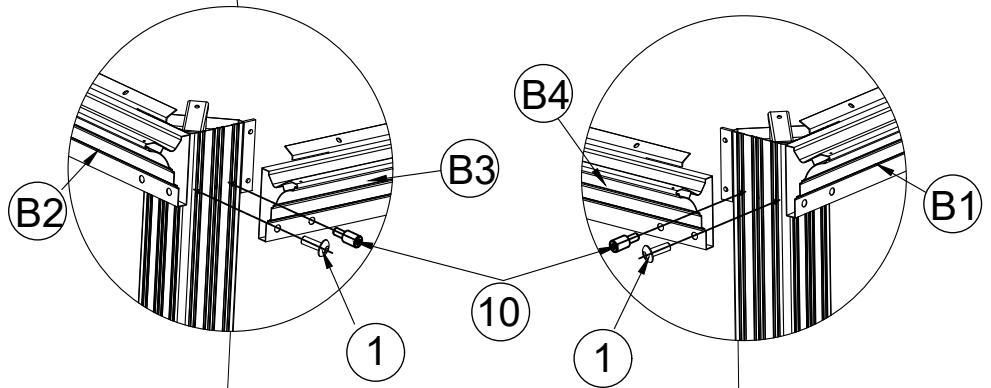
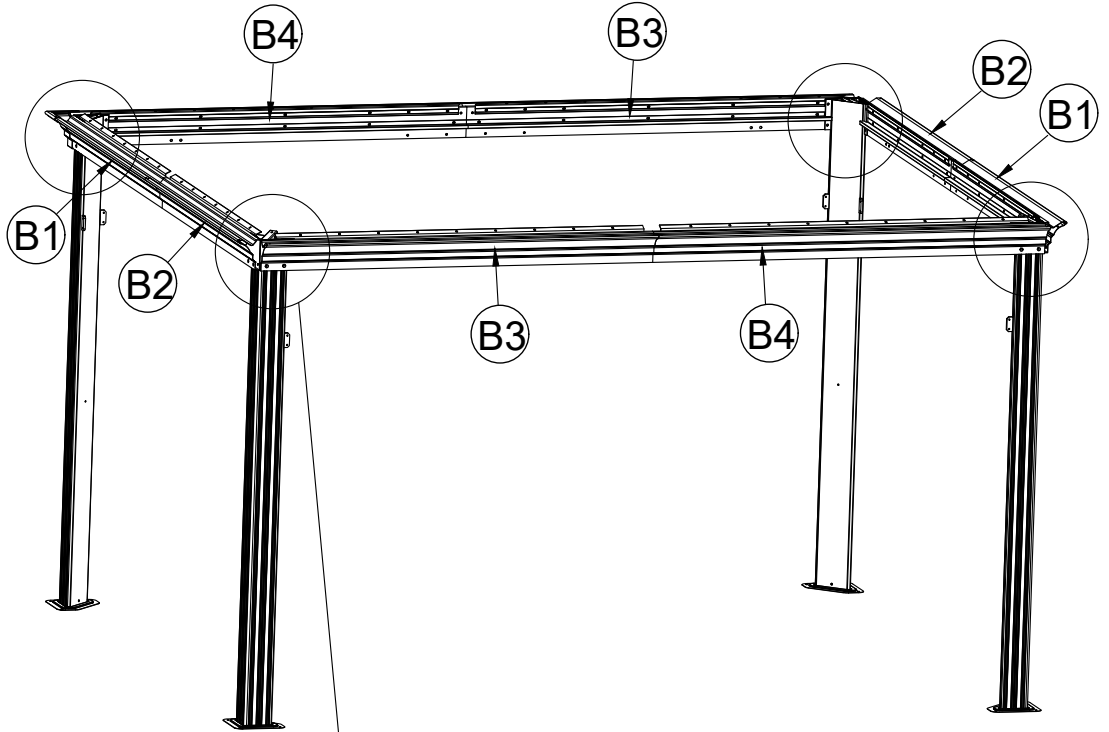

## STEP 06

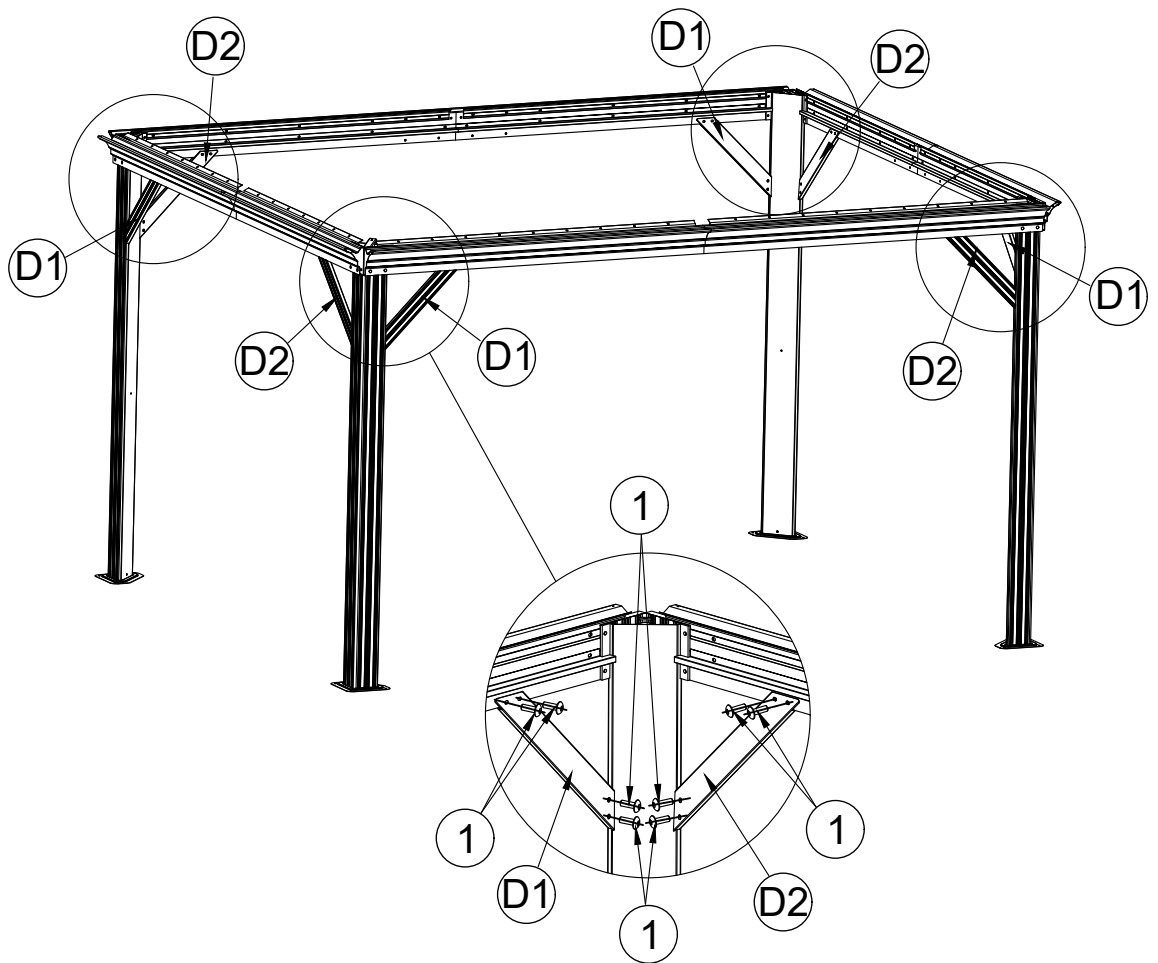
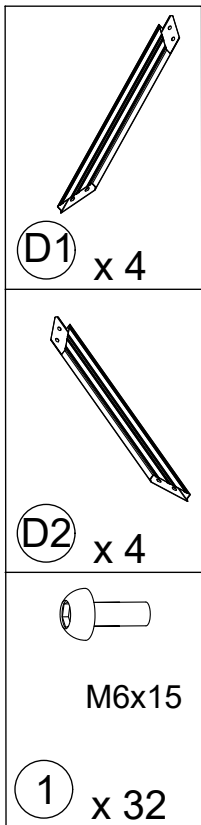

EN: Firstly, install the screws on the beam, but do not tighten them. After the uprights are tightened, then tighten the screws all. If the hole position is not aligned, move the uprights to adjust the position.









DE: Installieren Sie zunächst die Schrauben am Träger, ziehen Sie sie jedoch nicht fest. Nachdem die Pfosten festgezogen sind, ziehen Sie alle Schrauben fest. Wenn die Lochposition nicht ausgerichtet ist, bewegen Sie die Pfosten, um die Position anzupassen.

ES: Primero, instale los tornillos en la viga, pero no los apriete. Después de apretar los postes verticales, apriete todos los tornillos. Si la posición del agujero no está alineada, mueva los postes para ajustar.

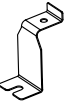
FR: Tout d'abord, installez les vis sur le faisceau, mais ne pas les serrer. Une fois les montants serrés, serrez les vis. Si la position du trou n'est pas alignée, déplacez les montants pour ajuster la position.



IT: Innanzitutto, installare le viti sulla trave, ma non stringerle tutte. Dopo che i montanti sono stati fissati, stringere le viti. Se la posizione del foro non è allineata, muovere i montanti al fine di regolarne la posizione.

STEP 07

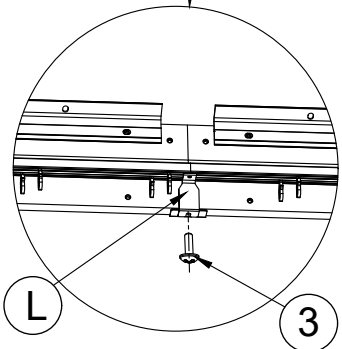
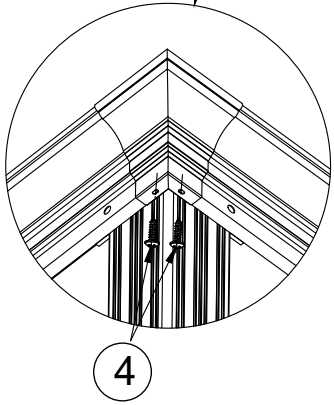
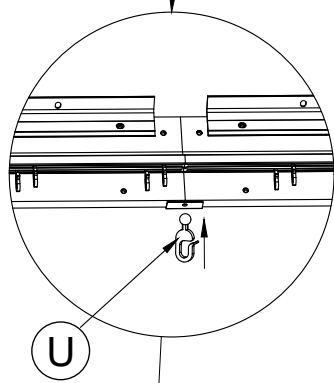
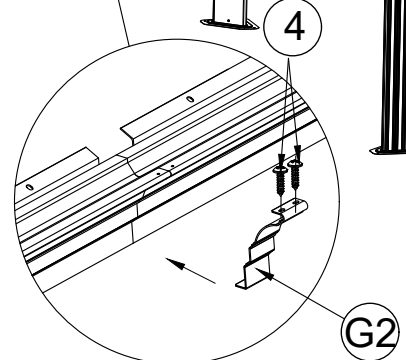
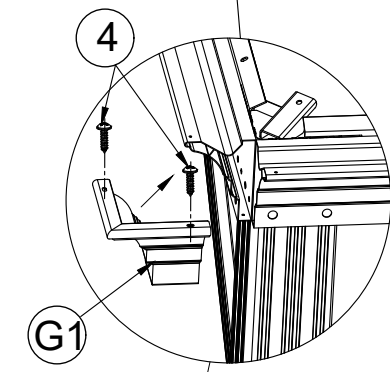
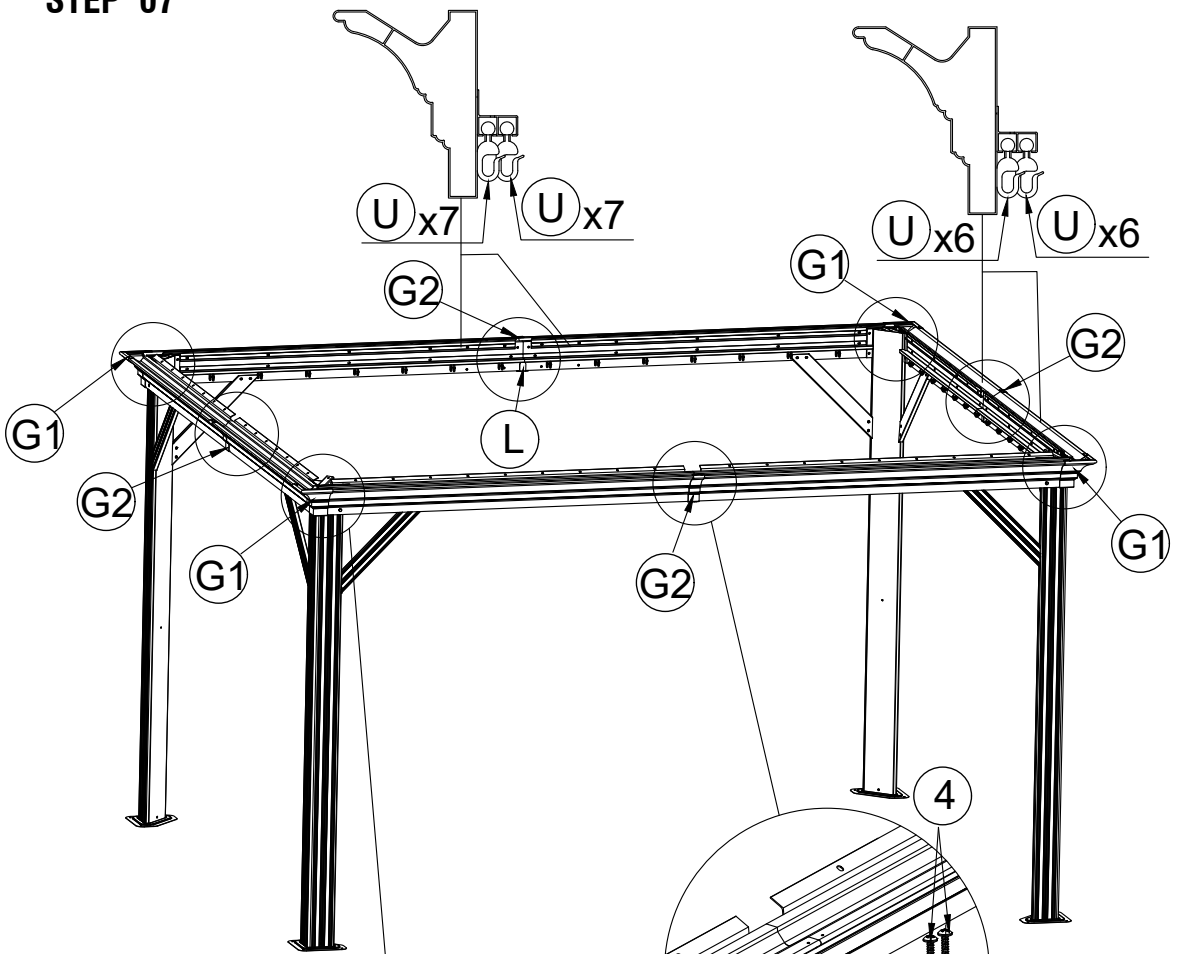
-  **G1** x 4
-  **G2** x 4
-  **L** x 4
-  **U** x 104
-  **M5x12**
-  **3** x 4
-  **ST4.8x12**
-  **4** x 24

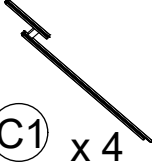

STEP 08

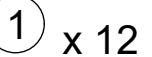
-  **C1** x 4
-  **J1** x 1
-  **M6x15**
-  **1** x 12

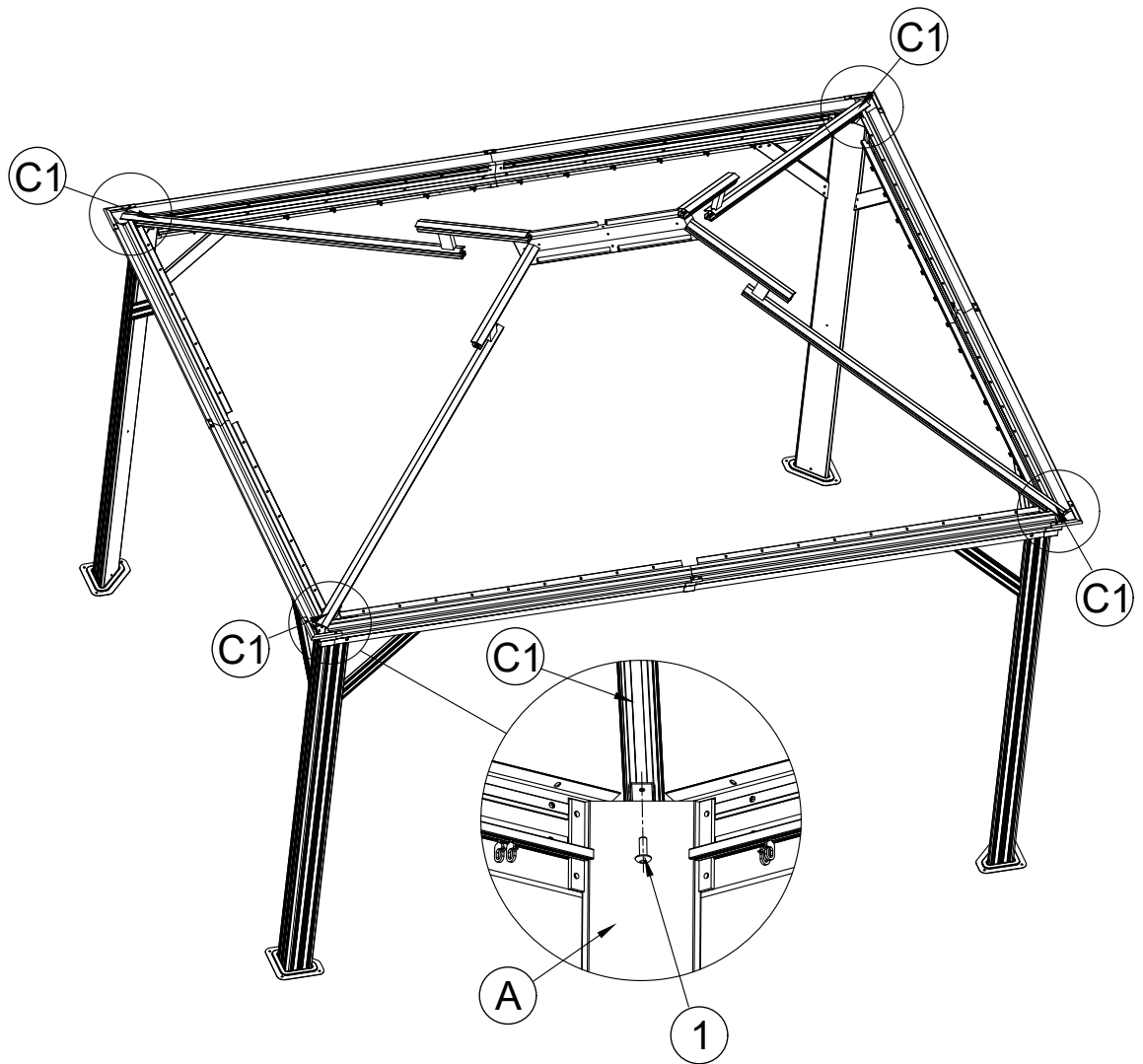
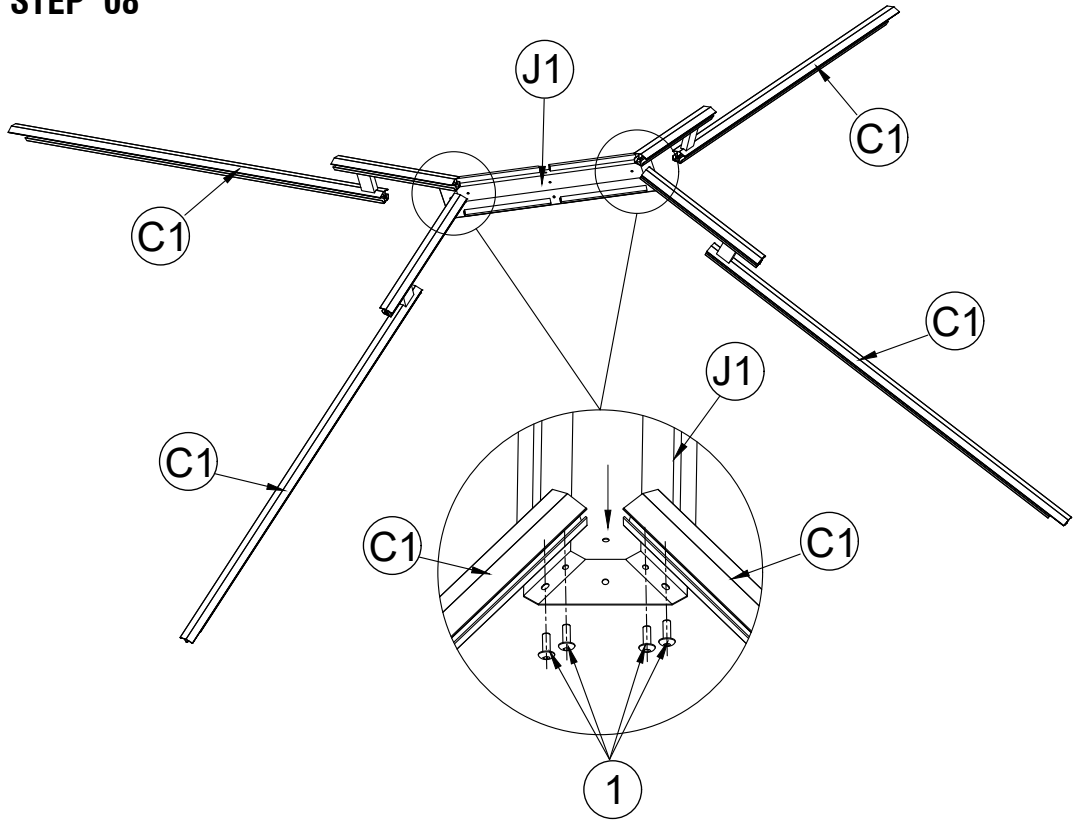

STEP 09

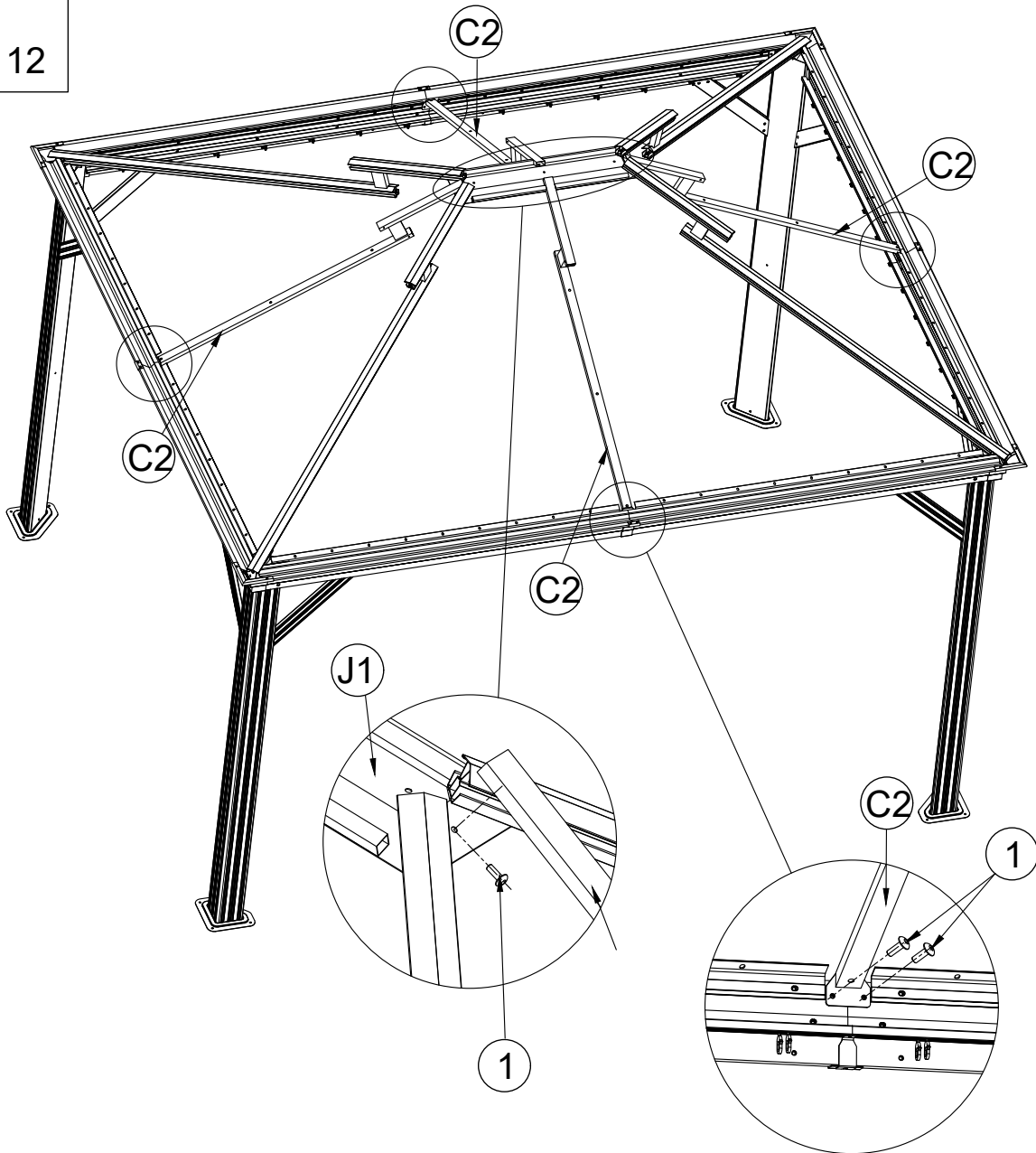
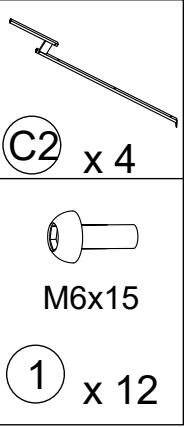

## STEP 10



J2 x 1

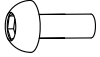

M6x15

1 x 1

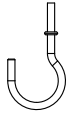

5 x 2

EN: Do not tighten these three screws now, and tighten them after 19 steps are completed.

DE: Ziehen Sie diese drei Schrauben jetzt nicht fest und ziehen Sie sie erst nach 19 Schritten fest.



ES: No apriete estos 3 tornillos ahora, después de completar el Paso 19, ya puede apretarlos.

FR: Ne serrez pas ces trois vis maintenant, et serrez-les après 19 étapes sont terminées.

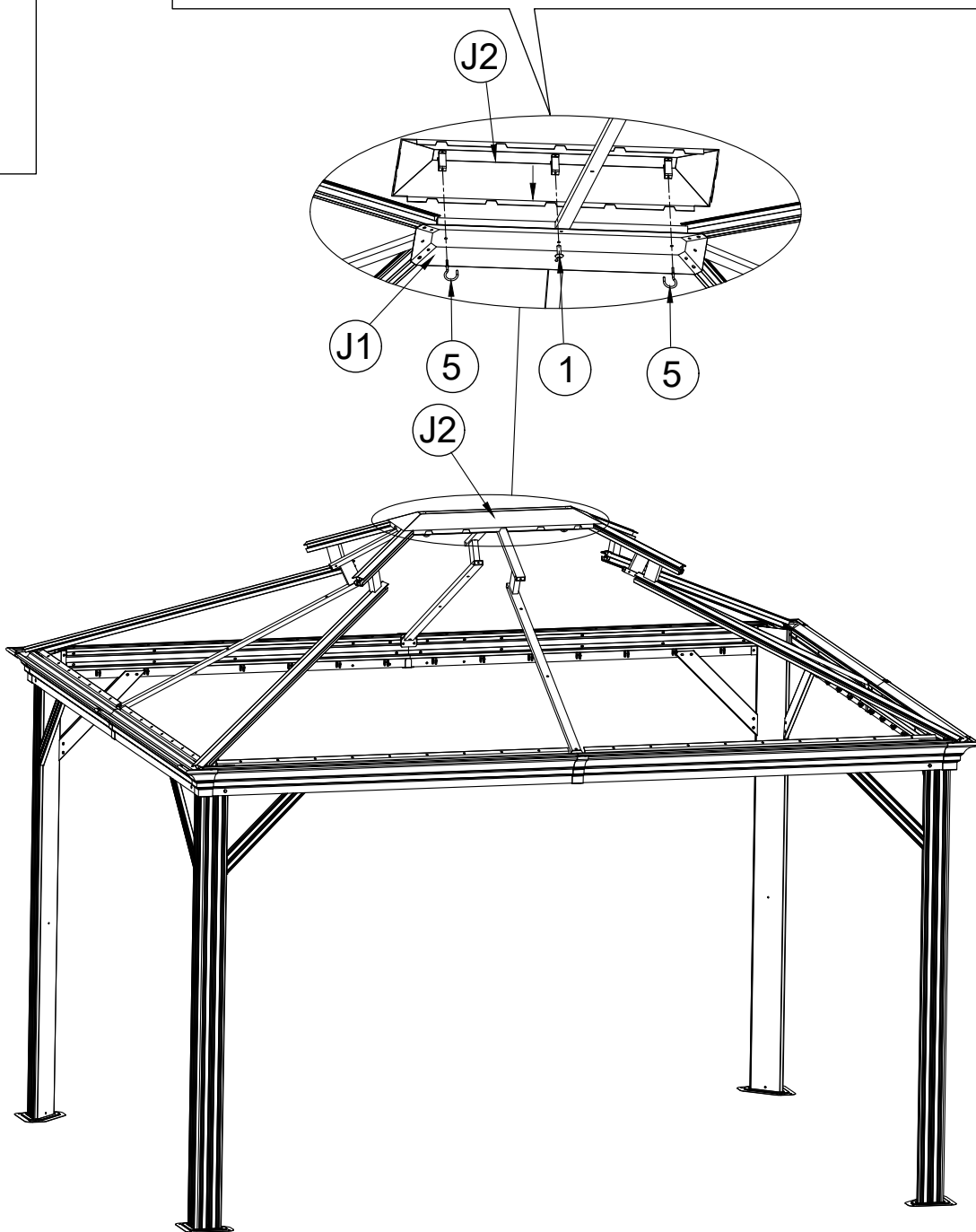
IT: Non stringere queste viti ora, ma stringerle dopo il completamento dei 19 passaggi.





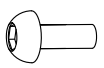

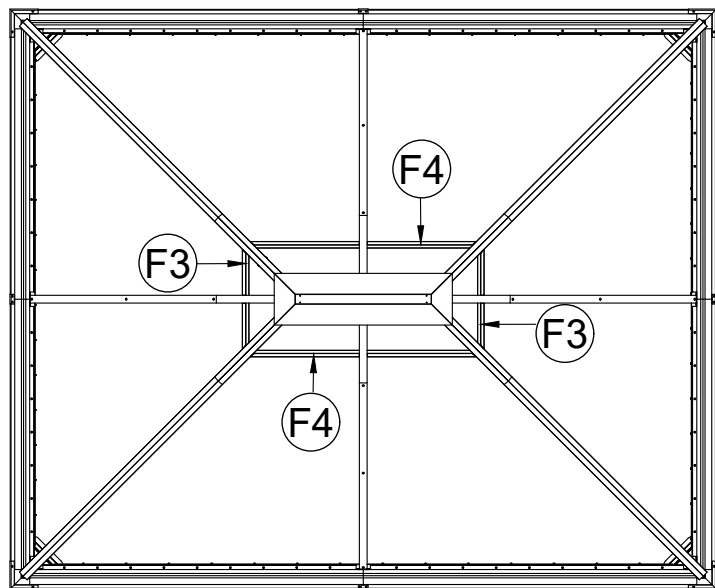
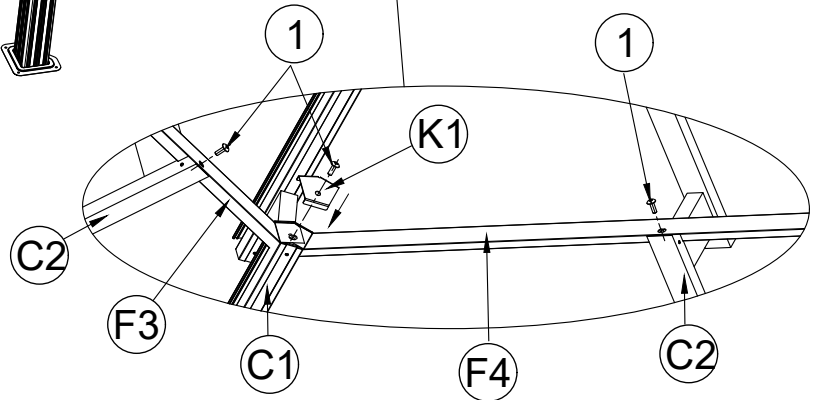
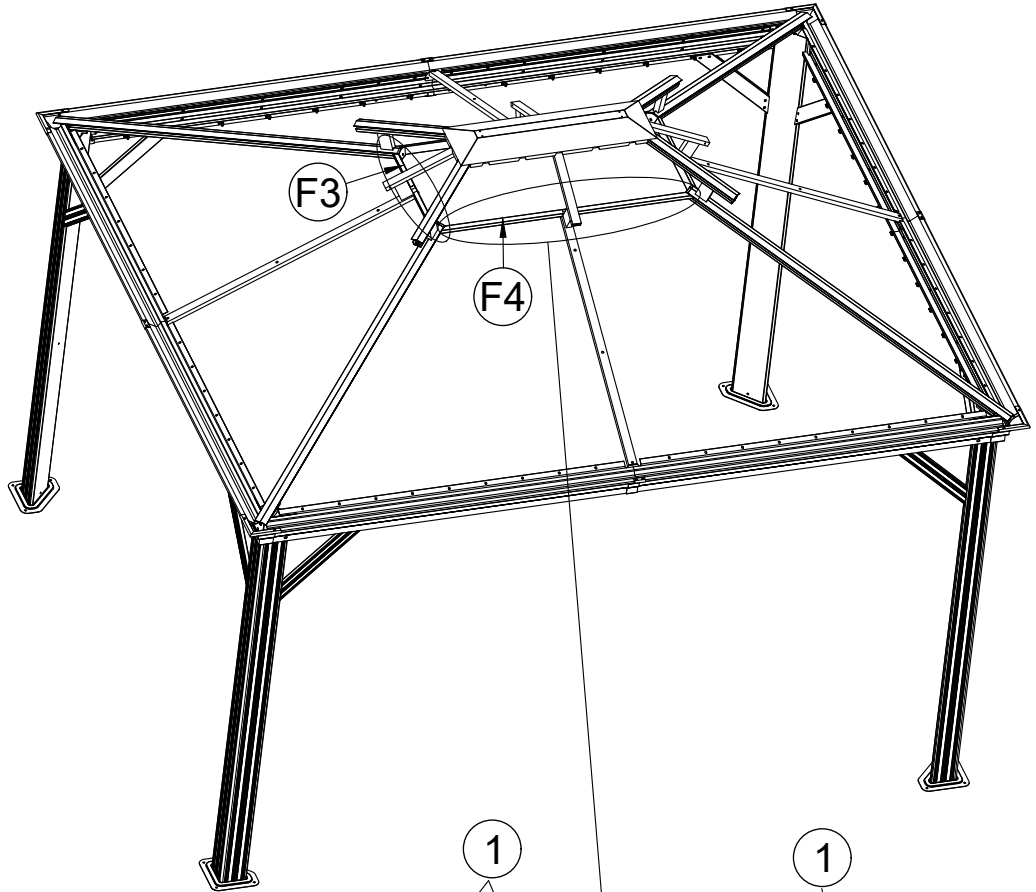
# STEP 11

- 
- F3** x 2
- 
- F4** x 2
- 
- K1** x 4
- 
- M6x15
- 1** x 8



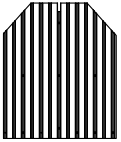
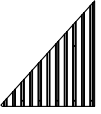
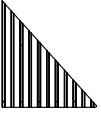
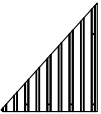
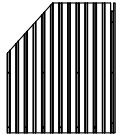
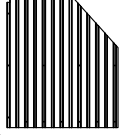
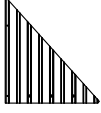

STEP 12



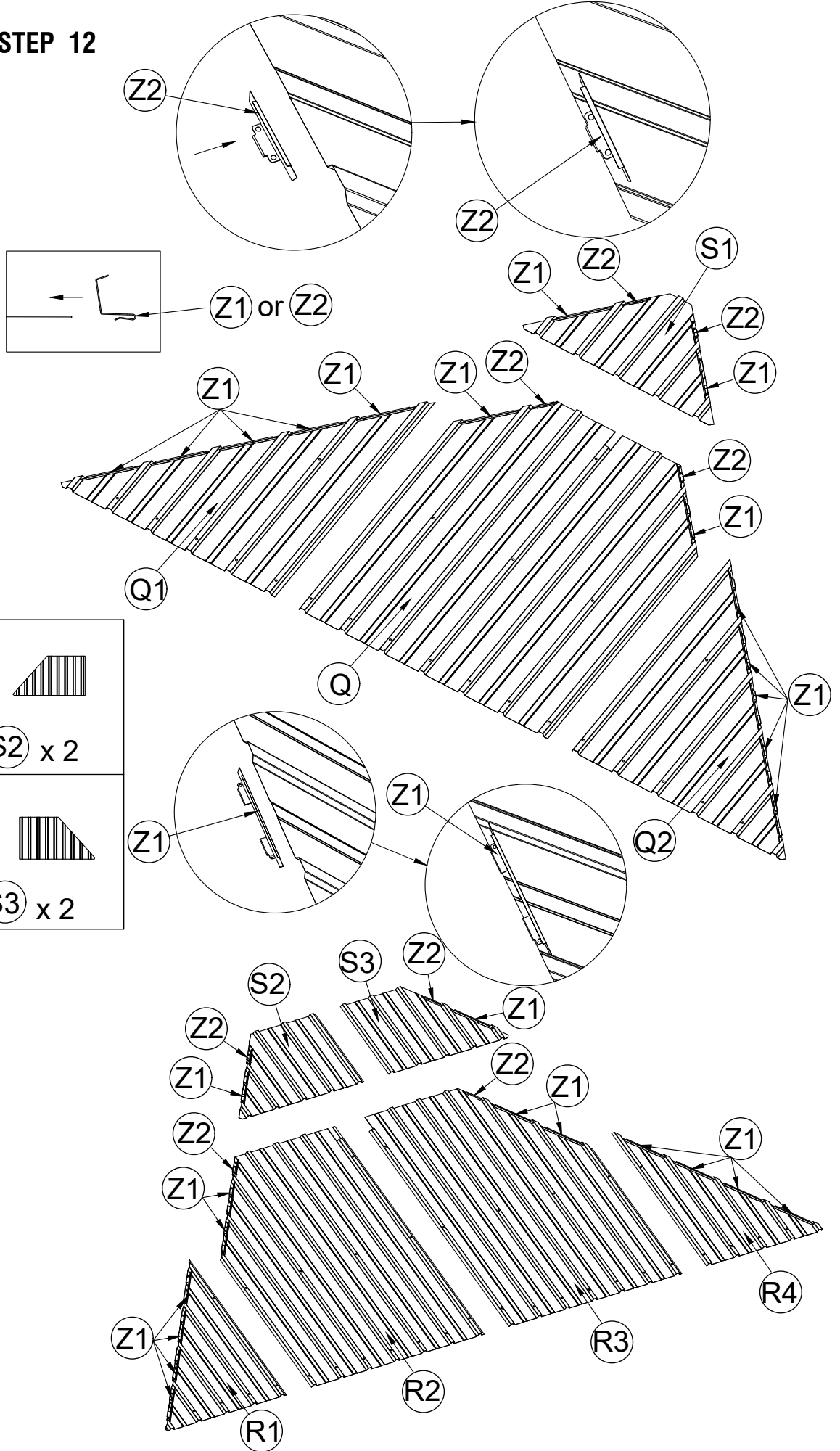

-  **Q** x 2
-  **Q1** x 2
-  **Q2** x 2
-  **R1** x 2
-  **R2** x 2
-  **R3** x 2
-  **R4** x 2
-  **S1** x 2
-  **Z1** x 56
-  **Z2** x 16

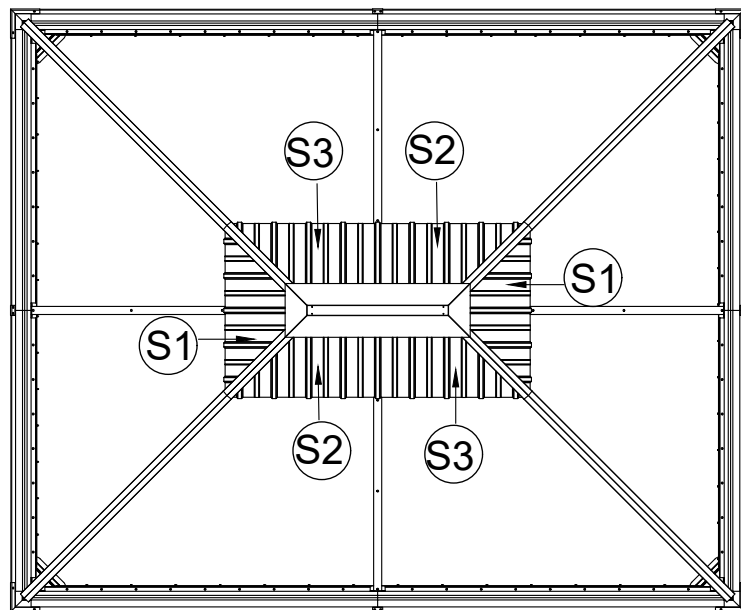
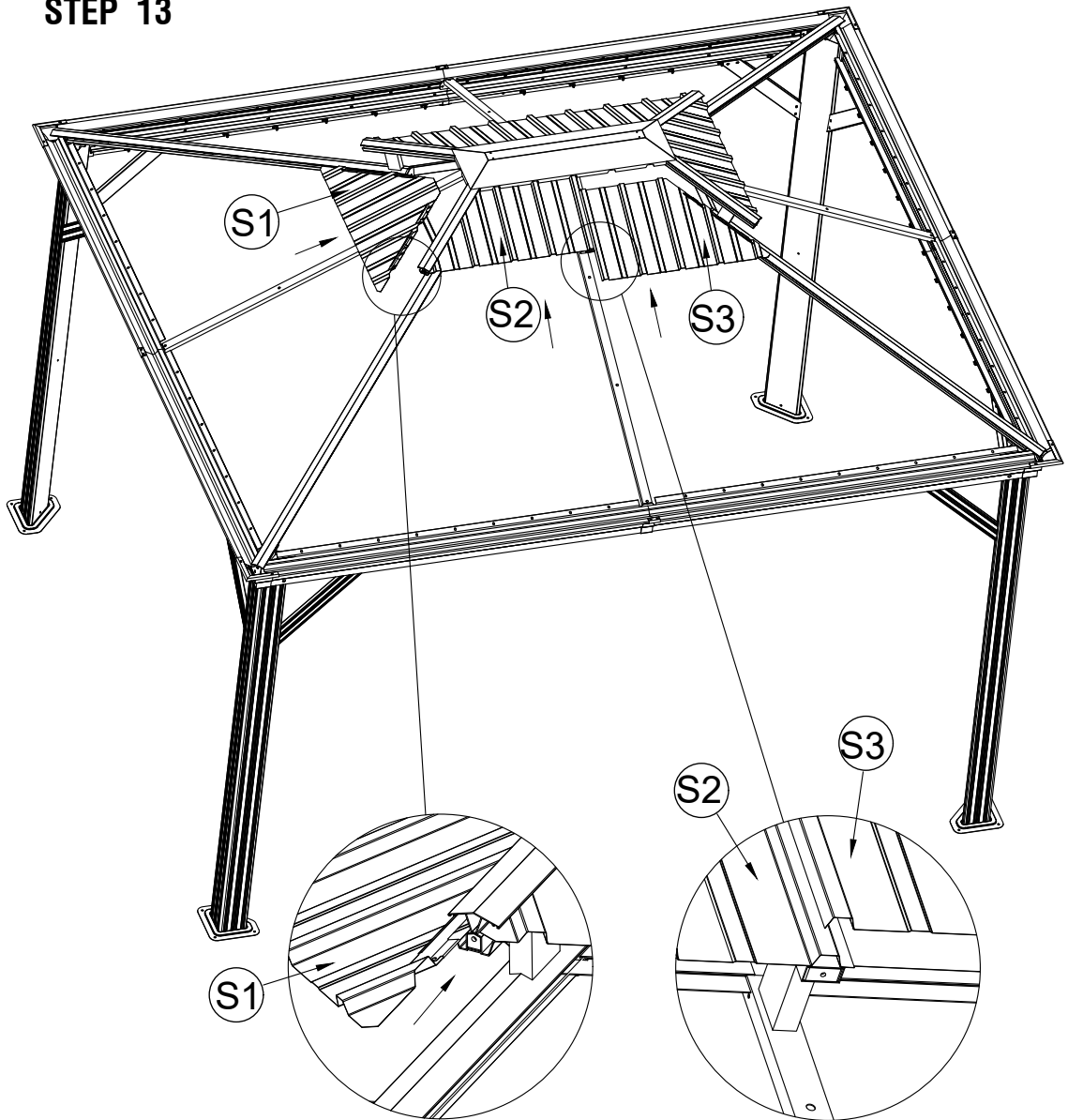

STEP 13

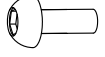
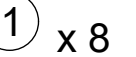

STEP 14

-   
F1 x 2
-   
F2 x 2
-   
K1 x 4
-   
K2 x 4
-   
M6x15
-   
1 x 8

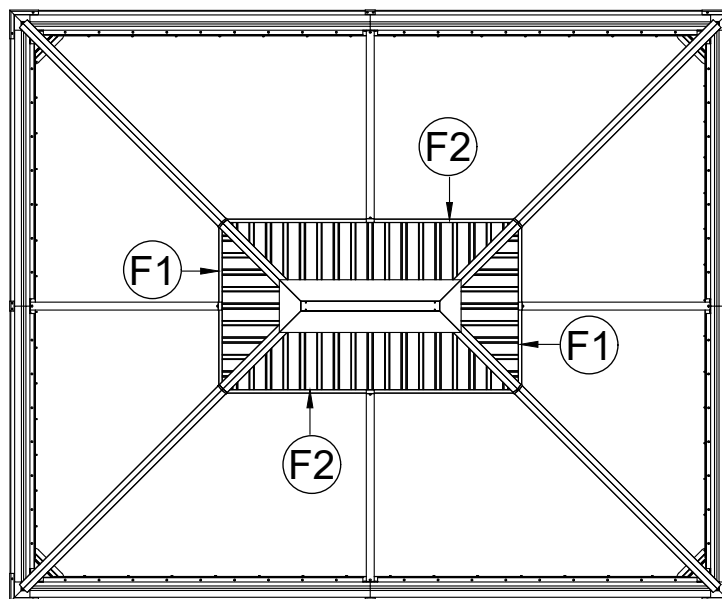
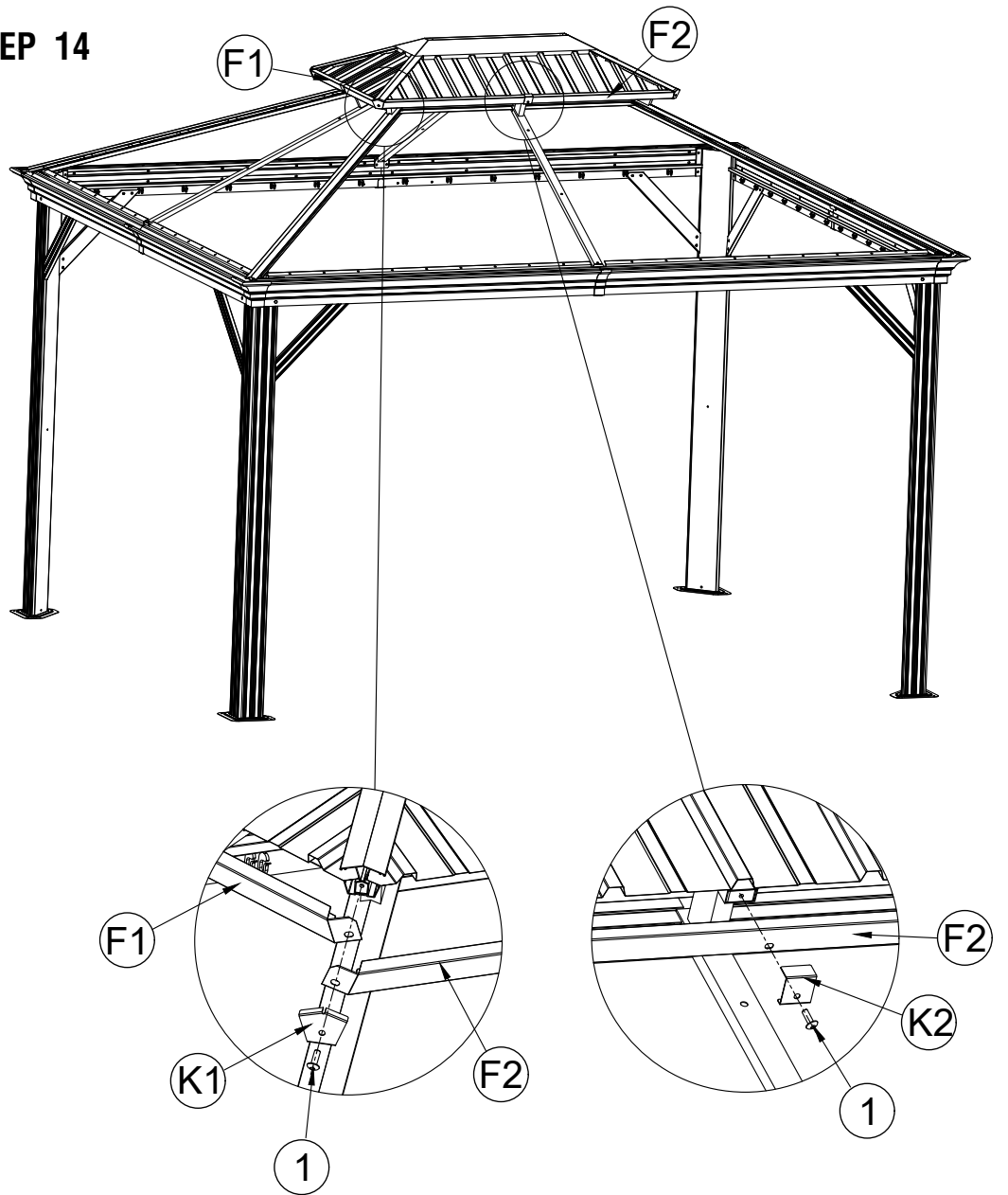

## STEP 15

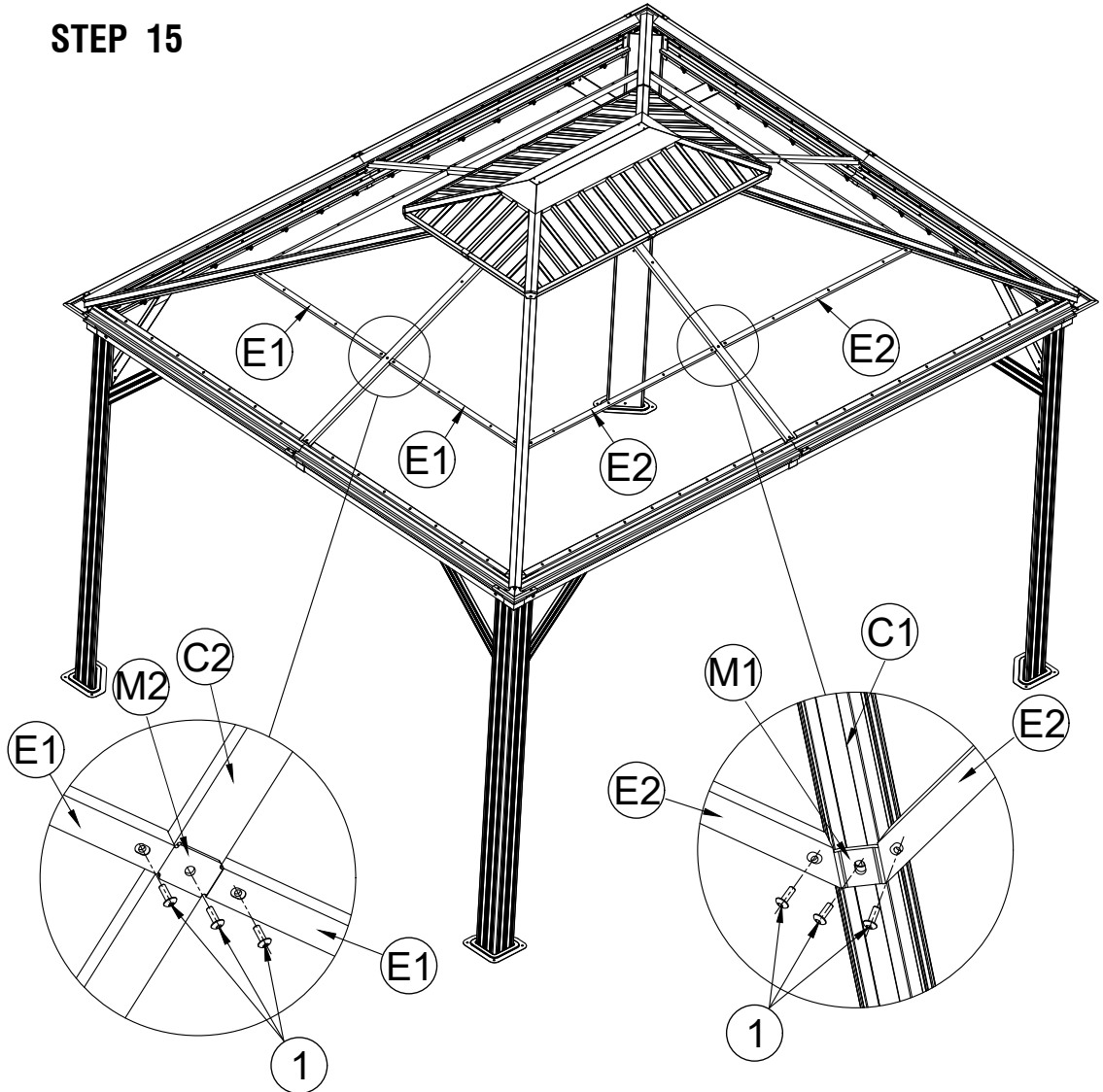
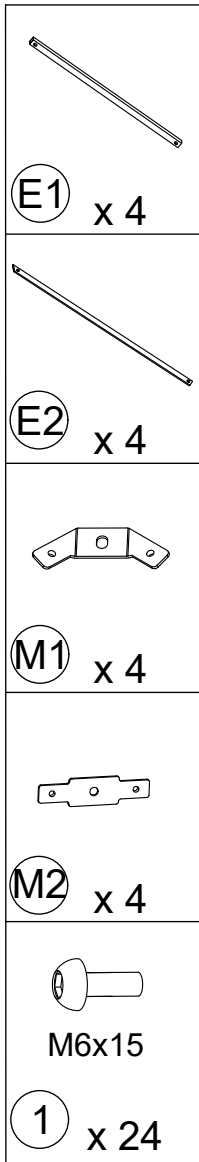

EN: Install in the same direction, do not tighten screws fully until all parts are connected.

DE: Installieren Sie in die gleiche Richtung und ziehen Sie die Schrauben nicht fest an, bis alle Teile angeschlossen sind.

ES: Instale en la misma dirección, no apriete los tornillos de manera completa hasta que todas las partes estén conectadas.

FR: Installez dans le même sens, ne serrez pas les vis à fond tant que toutes les pièces ne sont pas connectées.

IT: Installare nella stessa direzione, non stringere le viti completamente finché tutte le parti non sono state connesse.

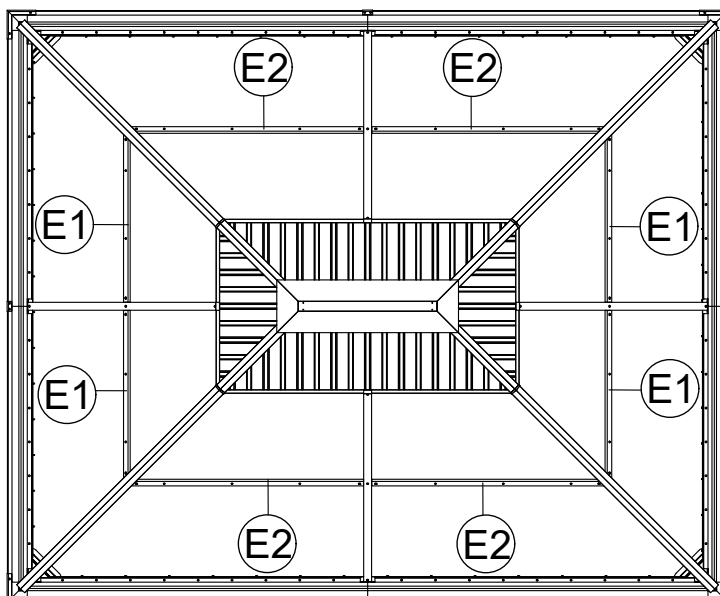

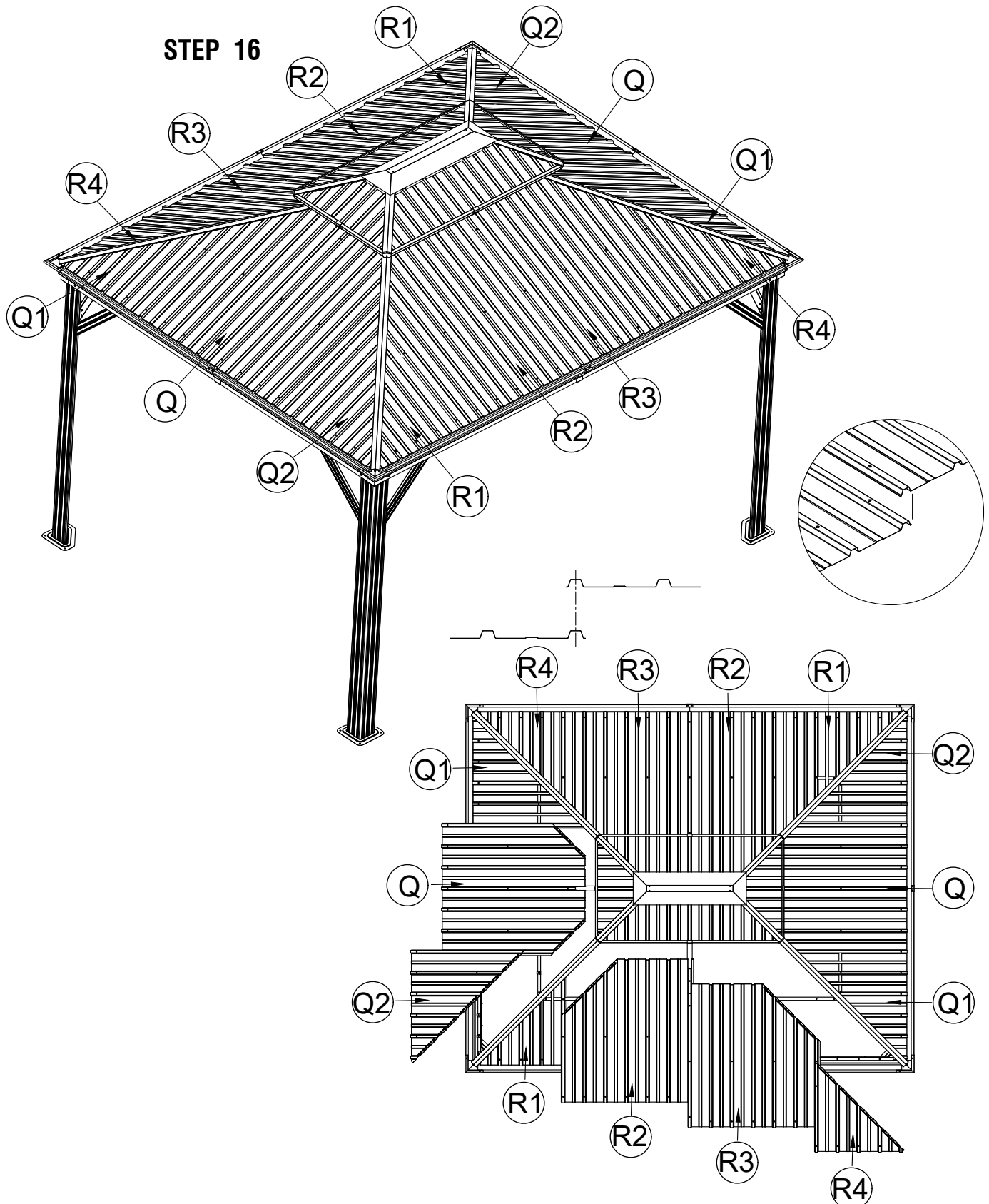

EN:This letter does not indicate the installation steps,just a schematic diagram of the iron plate distribution.The iron plate must be installed from left to right,not from right to left.

DE:Dieser Buchstabe gibt nicht die Installationsschritte an, sondern nur eine schematische Darstellung der Verteilung von Eisenplatten.Die Eisenplatte muss von links nach rechts und nicht von rechts nach links installiert werden.

ES:Esta letra no indica los pasos de instalación, sino un diagrama esquemático de la distribución de la placa de hierro. La placa de hierro debe ser instalada de izquierda a derecha,no puede ser de derecha a izquierda.

FR:Cette lettre n'indique pas les étapes d'installation, mais juste un schéma s de la distribution des plaques de fer.La plaque de fer doit être installée de gauche à droite, et non de droite à gauche.

IT:Questa lettera non indica uno step di installazione, bensì un diagramma schematico della distribuzione della piastra in metallo.La piastra in metallo va installata da sinistra a destra, e non da destra a sinistra.

STEP 17

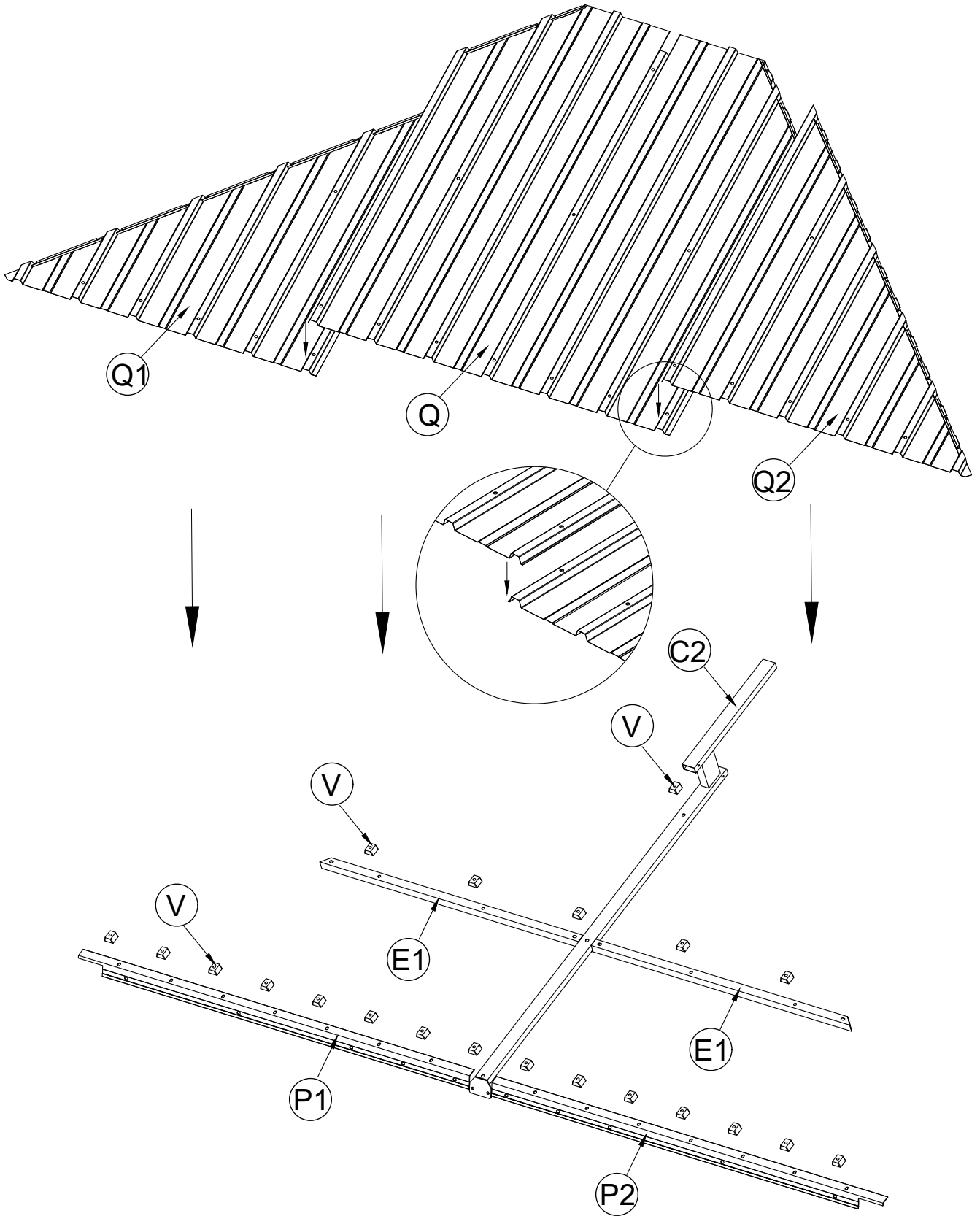

## STEP 18

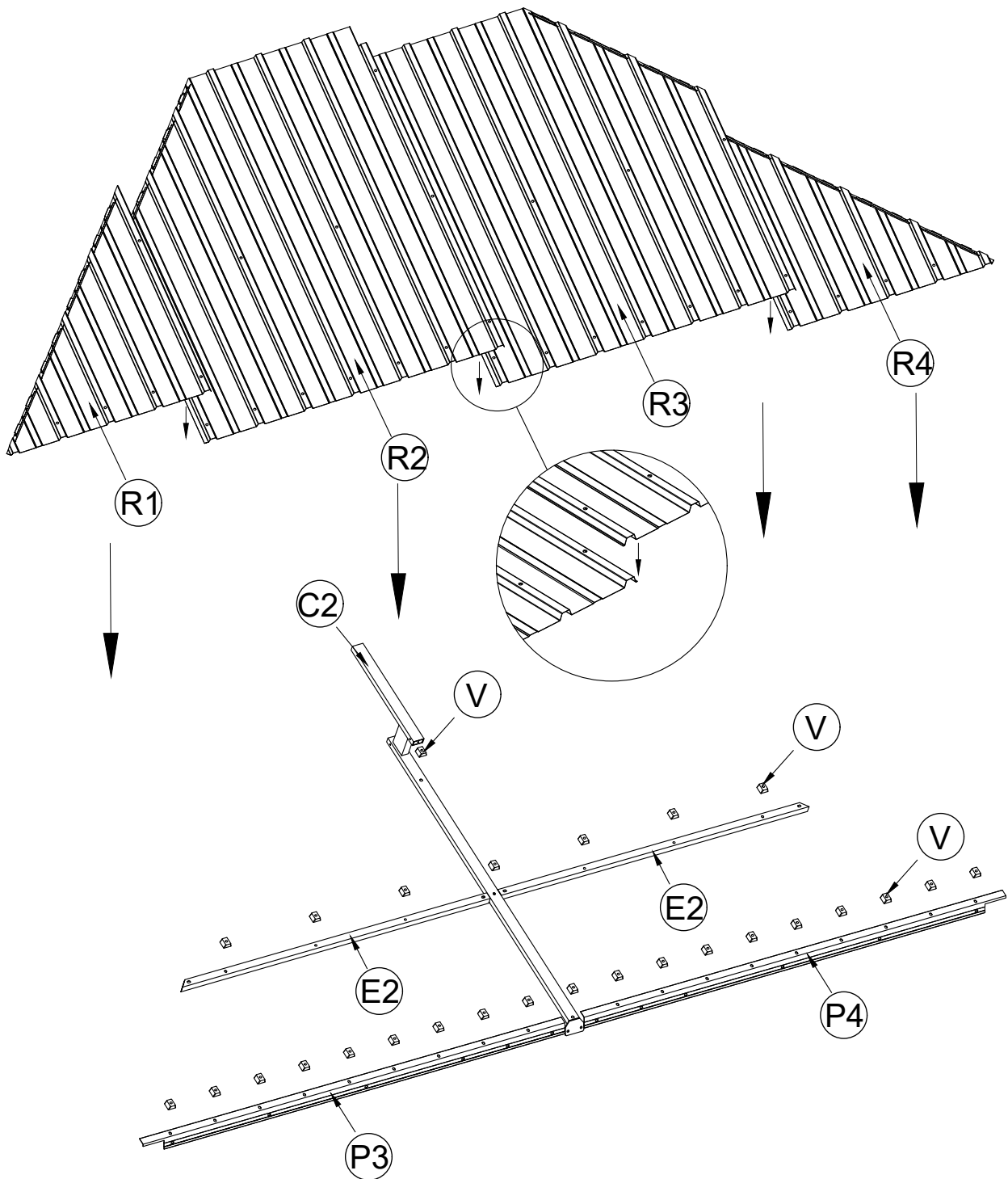

EN: The place marked with V can not be without installation, otherwise it may cause water leakage.

DE: Die mit V gekennzeichnete Stelle kann ohne Installation nicht übersprungen werden, da sonst Wasser austreten kann.

ES: Cada lugar marcado con V debe instalarse, cuya instalación no se puede omitir, de lo contrario puede causar fugas de agua.

FR: L'emplacement marqué d'un V ne peut pas être sans installation, sinon il peut y avoir des fuites d'eau.

IT: La posizione marcata con la V non può non essere installata, altrimenti questo potrebbe causare perdite.

# STEP 19



(V) x 96



x 4

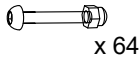

x 64

M6x23

(7) x 68

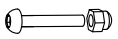

M6x42

(8) x 8



M6x47

(9) x 20

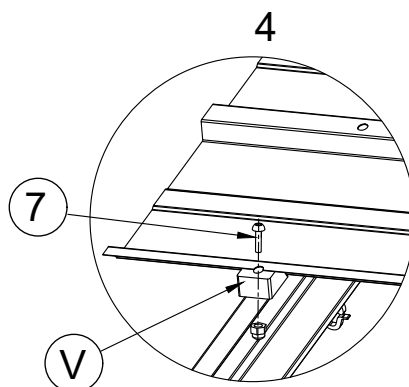
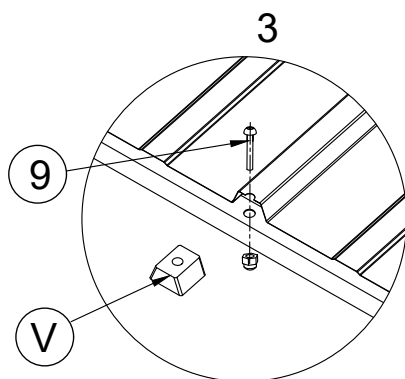
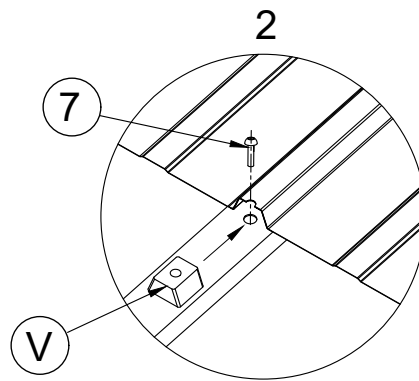
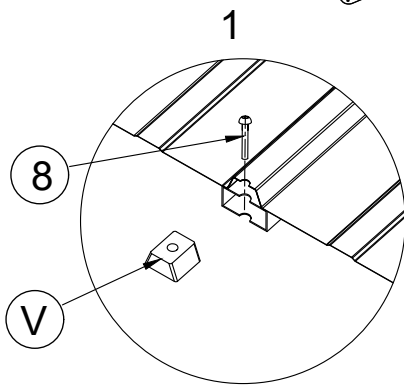
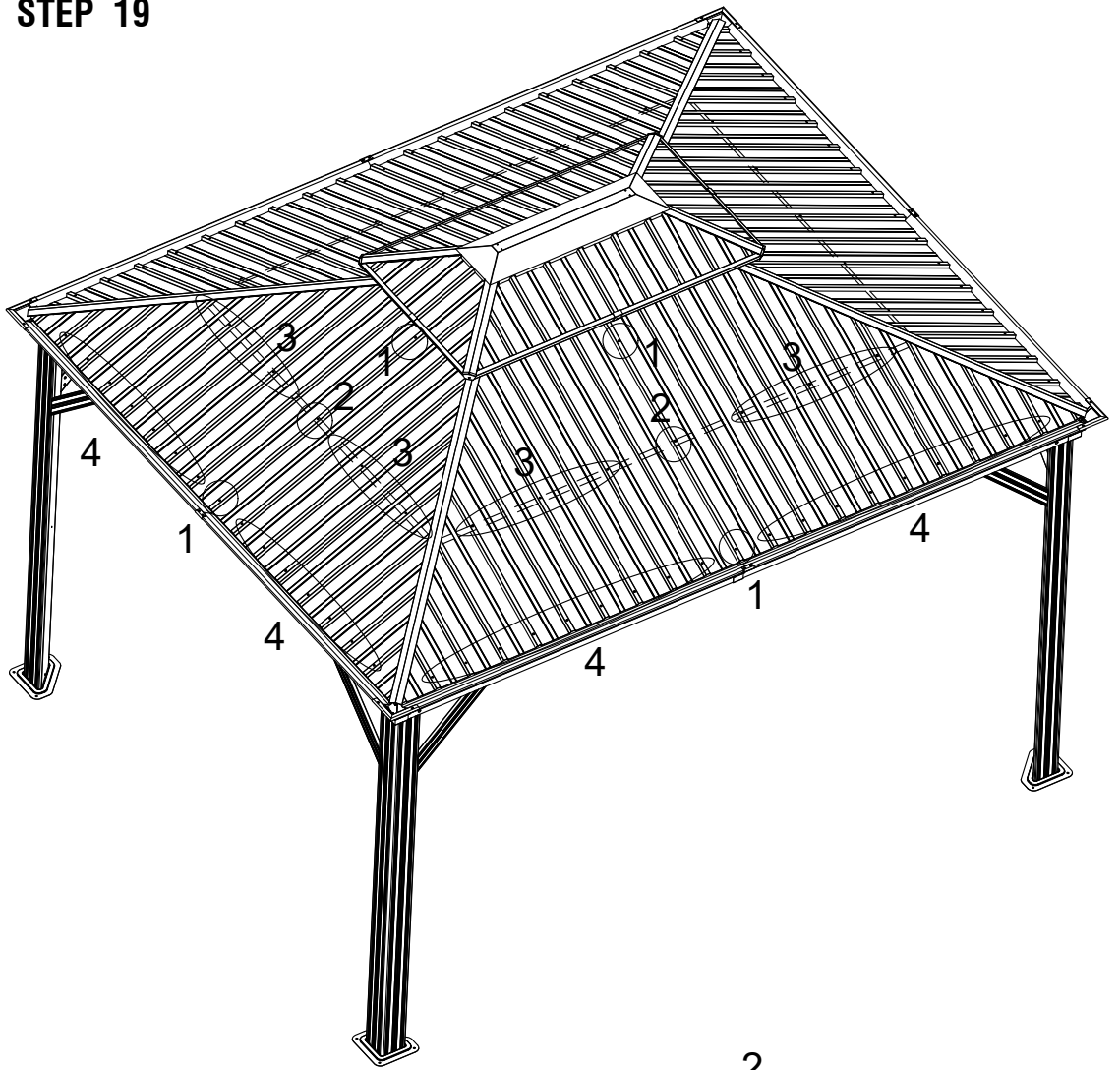



## STEP 20

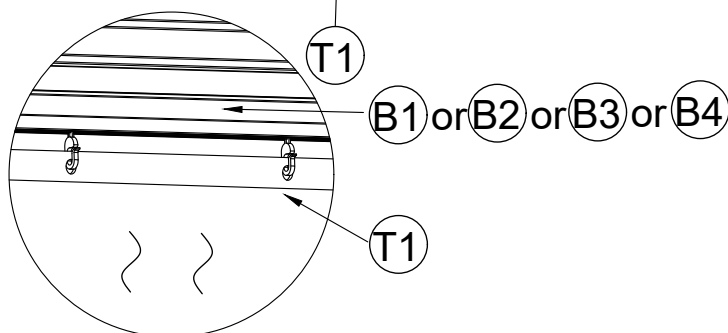
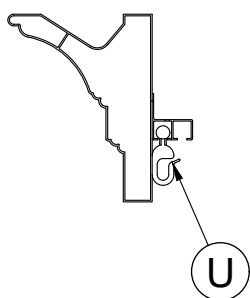
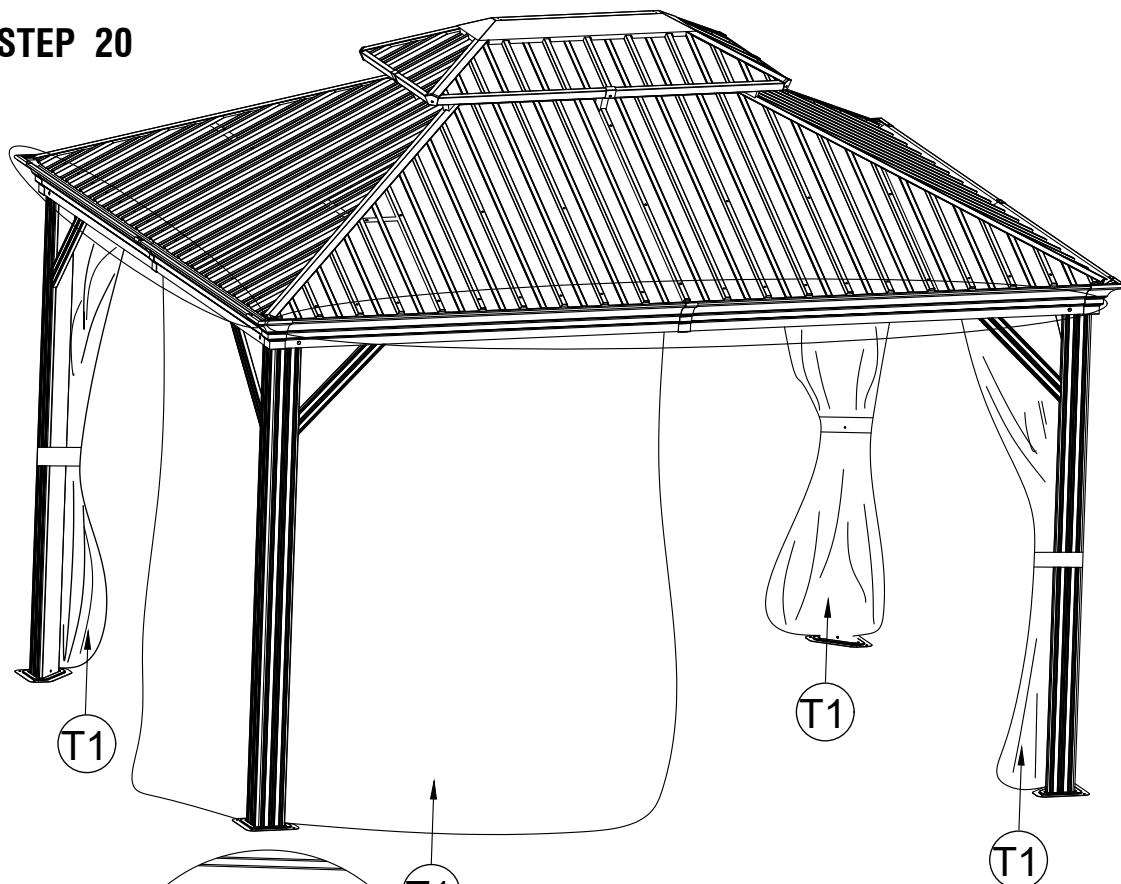
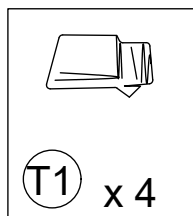

EN:1.T1 and T2 are divided into left and right directions,identification method:take apart the four zippers,and install T1/T2 in a single piece.The iron hook on T2 passes through the hole on T1 and hooks on the small hole of the upright.

2.There is no separate Bandage on T1,the Bandage has been sewn on T2.

DE: 1. T1 und T2 sind in linke und rechte Richtung unterteilt, Identifikationsmethode: Nehmen Sie die vier Reißverschlüsse auseinander und installieren Sie T1/T2 in einem Stück.Der Eisenhaken an T2 geht durch das Loch an T1 und hakt an dem kleinen Loch des Pfostens.

2.Es gibt keinen separaten Verband auf T1, der Verband wurde auf T2 genäht.

ES: 1.T1 y T2 se dividen en direcciones izquierda y derecha, el método de identificación es siguiente: Desmontar las cuatro cremalleras e instalar T1/T2 como una sola pieza.El gancho de hierro en T2 pasa a través del orificio en T1 y se engancha en el pequeño orificio del poste.

2.No hay un vendaje separado en T1, el vendaje se ha cosido en T2.

FR:1.T1 et T2 sont divisés en directions gauche et droite, méthode d'identification: démontez les quatre fermetures éclair, et installez T1/T2 en une seule pièce.Le crochet en fer sur T2 passe à travers le trou sur T1 et crochets sur le petit trou du montant.

2. Il n'y a pas de bandage séparé sur T1, le bandage a été cousu sur T2.

IT:1.T1 e T2 sono divisa tra direzione sinistra e destra , identificabili in questo modo: slacciare le quattro cerniere e installare T1/T2 in un solo pezzo. Il gancio in metallo su T2 passa attraverso il foro di T1 e si aggancia al piccolo foro del montante.

2.Non ci sono cinghie separate su T1, la cinghia e' stata cucita su T2.

STEP 21



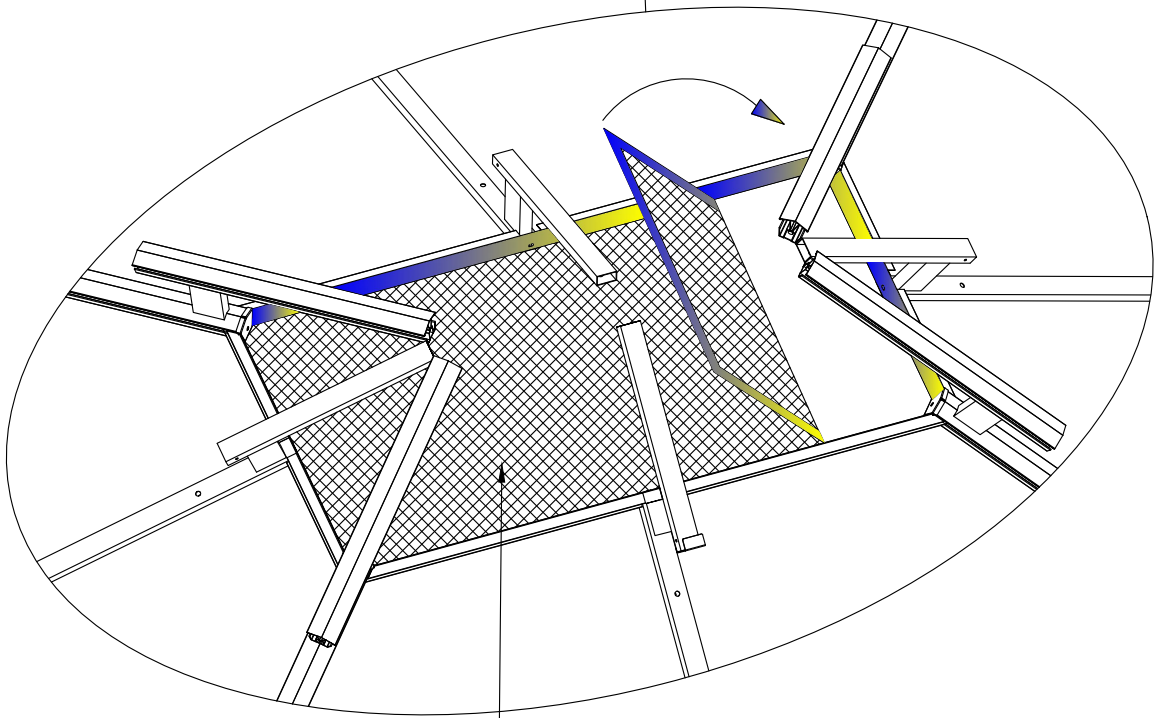
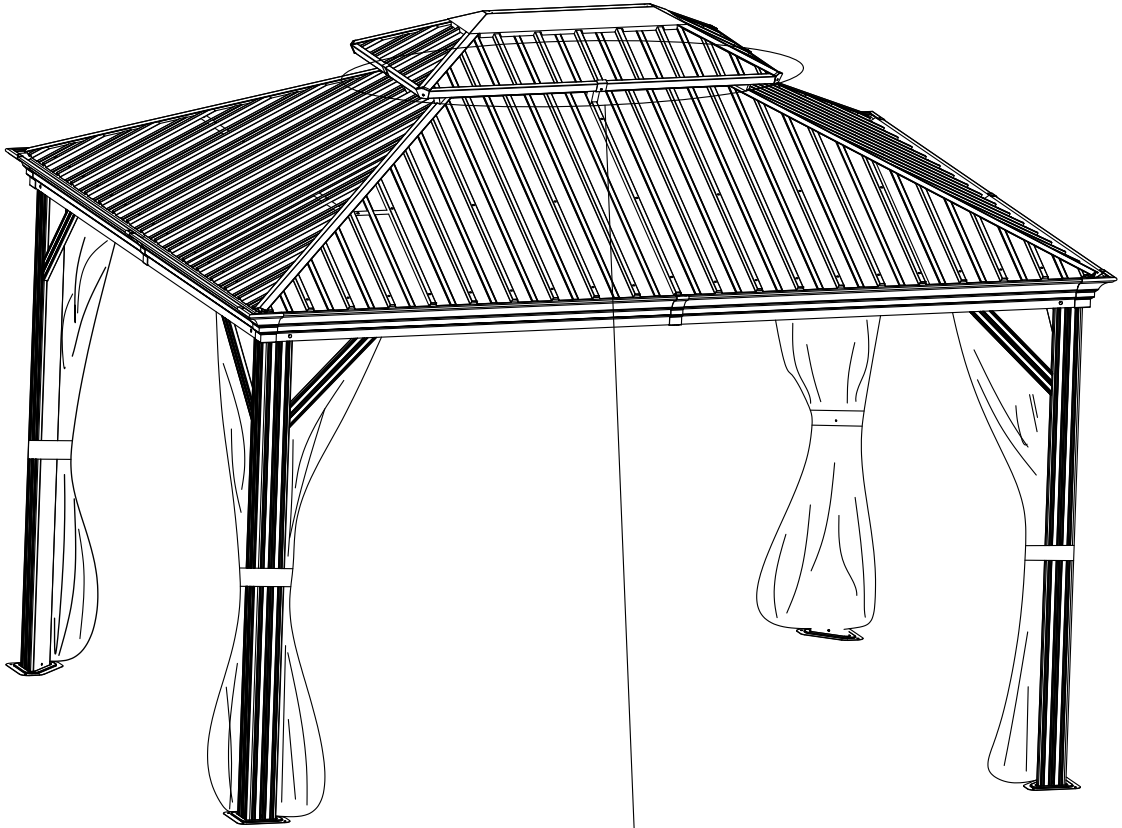

T3 x 1

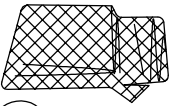

T3

STEP 22

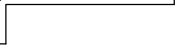
-  T2 x 4
-  M6x42
-  6 x 12
-  W x 12

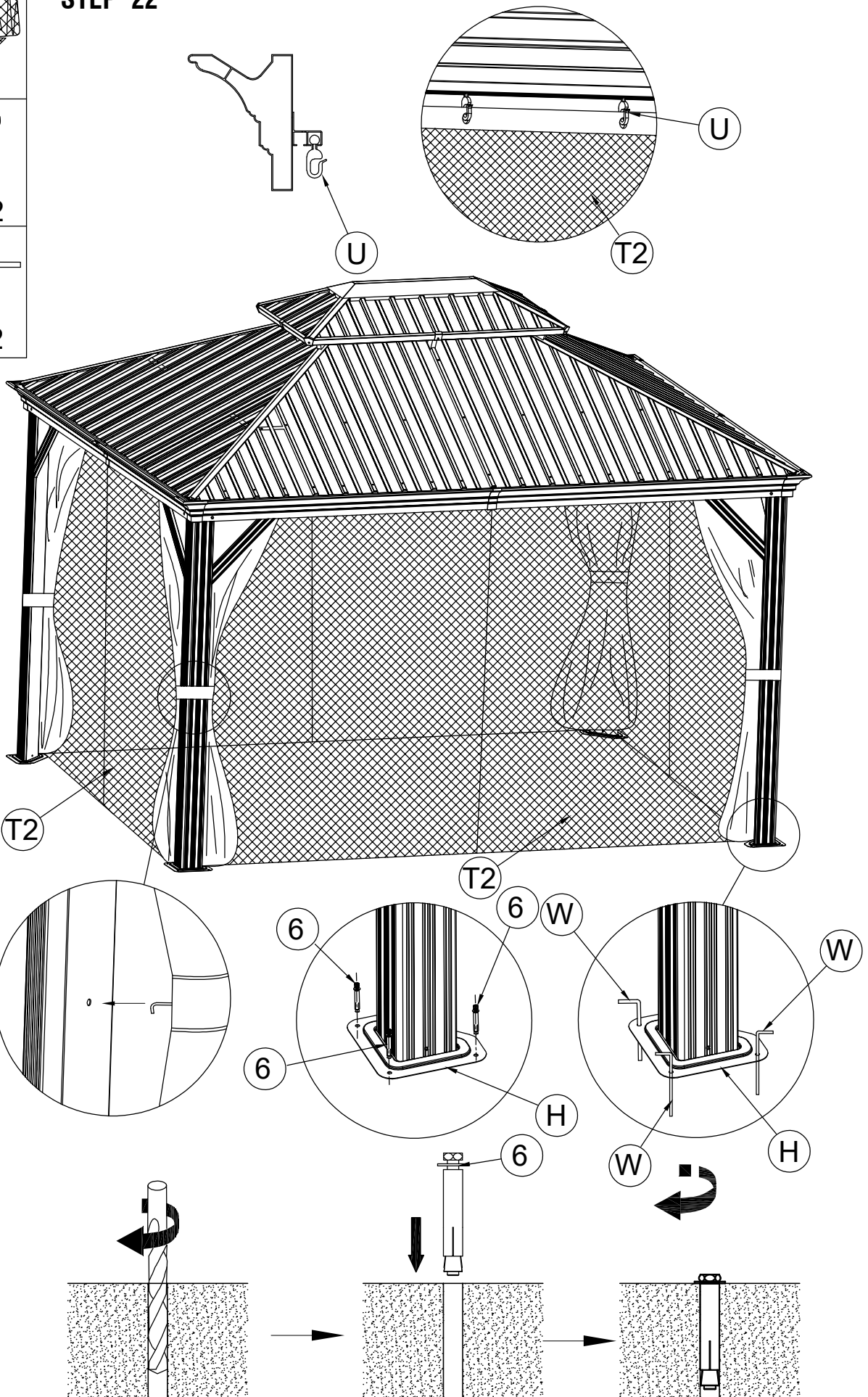

**US**

Imported by Aosom LLC  
27150 SW Kinsman Rd Wilsonville, OR 97070 USA  
MADE IN CHINA

**CA**

Imported by Aosom Canada Inc.  
1251 Tapscott Road, Unit 101, Scarborough, Ontario Canada M1X 1S9  
MADE IN CHINA

Importé par Aosom Canada Inc.  
1251 Rue Tapscott, Unité 101, Scarborough, Ontario Canada M1X 1S9  
FABRIQUÉ EN CHINE

**UK**

IMPORTER ADDRESS:  
MH STAR UK LTD  
Unit 27, Perivale Park,  
Horsenden lane South  
Perivale, UB6 7RH  
MADE IN CHINA

**FR**

ADRESSE D'IMPORTATION:  
MH FRANCE  
2 Rue Maurice Hartmann  
92130 Issy Les Moulineaux  
France  
FABRIQUÉ EN CHINE

**ES**

IMPORTADOR:  
SPANISH AOSOM, S.L.  
C/ROC GROS,Nº15.08550, ELS HOSTALETS DE BALENYÀ, SPAIN.  
B66295775  
WWW.AOSOM.ES  
ATENCIONCLIENTE@AOSOM.ES  
TEL: 931294512  
HECHO EN CHINA

**DE**

ADRESSE DES IMPORTEURS:  
MH Handel GmbH  
Wendenstraße 309  
D-20537 Hamburg  
Germany  
IN CHINA HERGESTELLT

**IT**

IMPORTATO DA:  
AOSOM Italy srl  
Centro Direzionale Milanofiori  
Strada 1 Palazzo F1  
20057 Assago (MI)  
P.I.: 08567220960  
FATTO IN CINA