

# PawHut®

IN220800250V01\_GL

**D30-410**

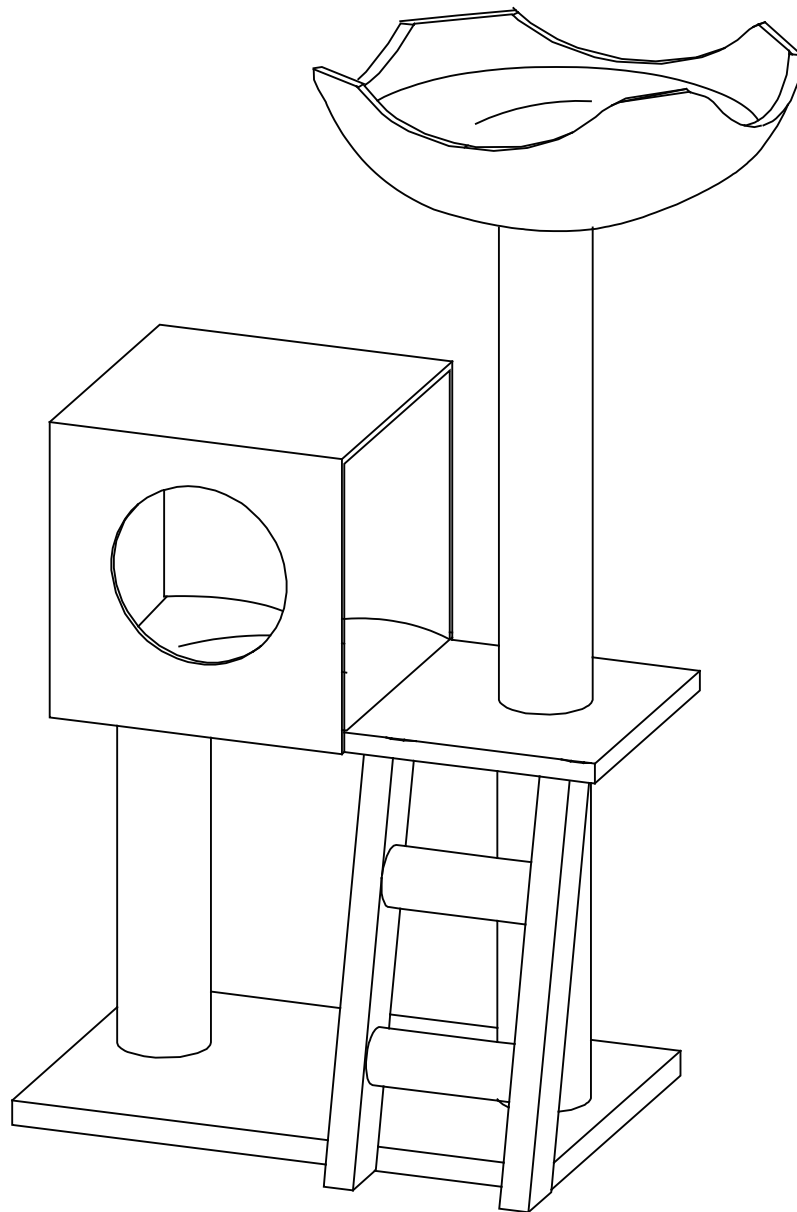

**EN\_IMPORTANT, RETAIN FOR FUTURE REFERENCE: READ CAREFULLY.**

**FR\_IMPORTANT: A LIRE ATTENTIVEMENT ET À CONSERVER POUR CONSULTATION ULTÉRIEURE.**

**ES\_IMPORTANTE, LEA Y GUARDE PARA FUTURAS REFERENCIAS.**

**DE\_WICHTIG! SORGFÄLTIG LESEN UND FÜR SPÄTER NACHSCHLAGEN AUFBEWAHREN.**

**IT\_IMPORTANTE! CONSERVARE IL PRESENTE MANUALE PER FUTURO RIFERIMENTO E LEGGERLO ATTENTAMENTE.**

**PARTS**

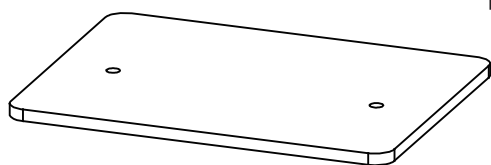

① x1

57\*37\*2cm

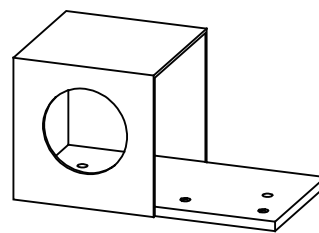

② x1

57\*31\*29.5cm



③ x1

D40\*12.5cm

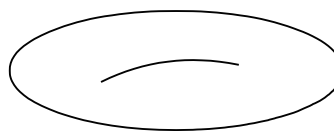

④ x1

D36cm

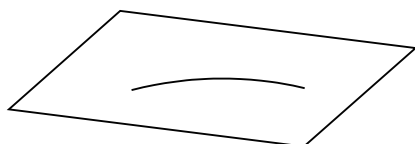

⑤ x1

30\*31cm

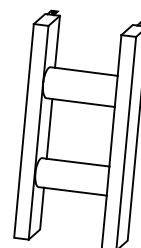

⑥ x1

19\*8\*44.5cm

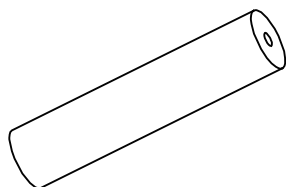

⑦ x2

D9\*40cm

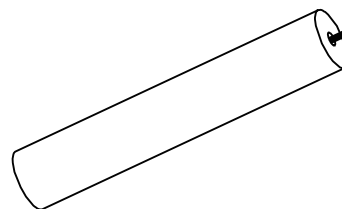

⑧ x1

D9\*45cm

**HARDWARE**

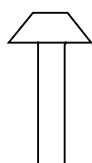

**A** x3

M8\*40MM

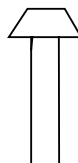

**B** x2

M8\*16MM



**C** x1

M8\*70MM

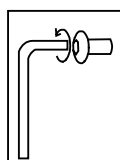

**D** x1

