

# PawHut

IN220800275V01\_GL

**D06-150V00**

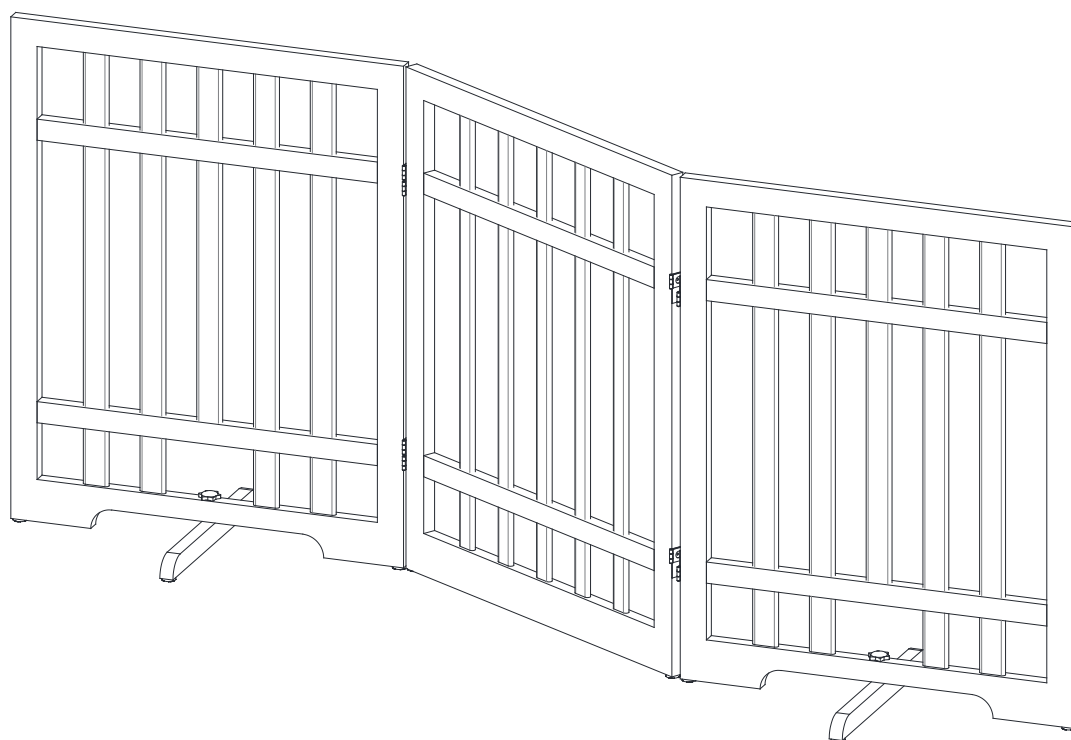

**EN\_IMPORTANT, RETAIN FOR FUTURE REFERENCE: READ CAREFULLY.**

**FR\_IMPORTANT: A LIRE ATTENTIVEMENT ET À CONSERVER POUR CONSULTATION  
ULTÉRIEURE.**

**ES\_IMPORTANTE, LEA Y GUARDE PARA FUTURAS REFERENCIAS.**

**DE\_WICHTIG! SORGFÄLTIG LESEN UND FÜR SPÄTER NACHSCHLAGEN AUFBEWAHREN.**

**IT\_IMPORTANTE! CONSERVARE IL PRESENTE MANUALE PER FUTURO RIFERIMENTO E  
LEGERLO ATTENTAMENTE.**

**PARTS**

**1** x 2

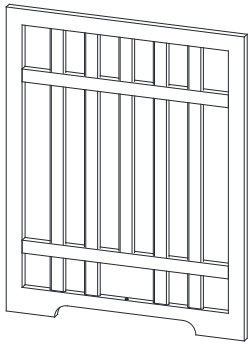

**2** x 1

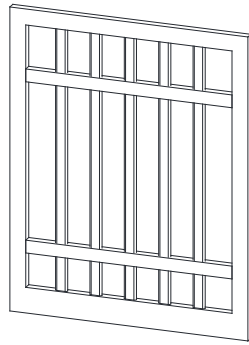

**3** x 2



**HARDWARE**

**A** x 04

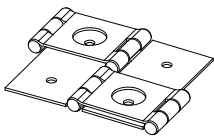

**B** x 02  
M6.0x40

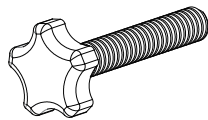

**C** x 10  
+1(spare)



**D** x 16  
M3.0x16  
+1(spare)

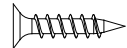

**01**

**1** x 02



**2** x 01



**A** x 04

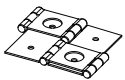

**D** x 16

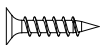

M3.0\*16

**A** x 1

**D** x 4

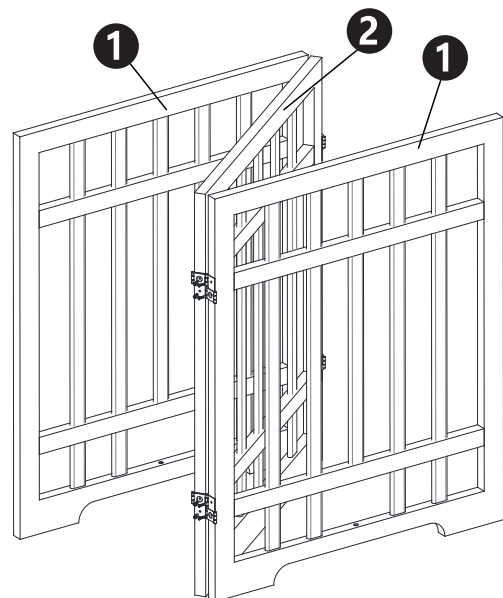
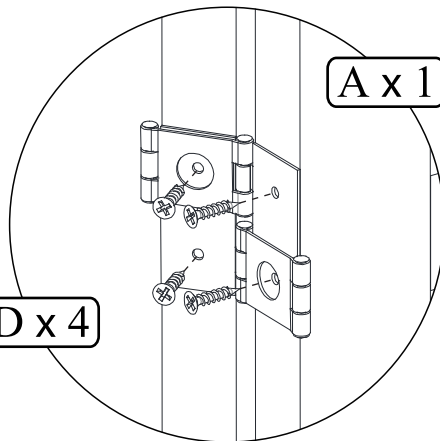

3 x 02



D x 02



M6.0\*40:

C x 10

