



## **Baby Stroller User's Manual**

### **Passeggino Manuale Utente**

- \* Suitable for children of 0-36 months.
- \* Adatto a bambini di 0-36 mesi.

# PARTS

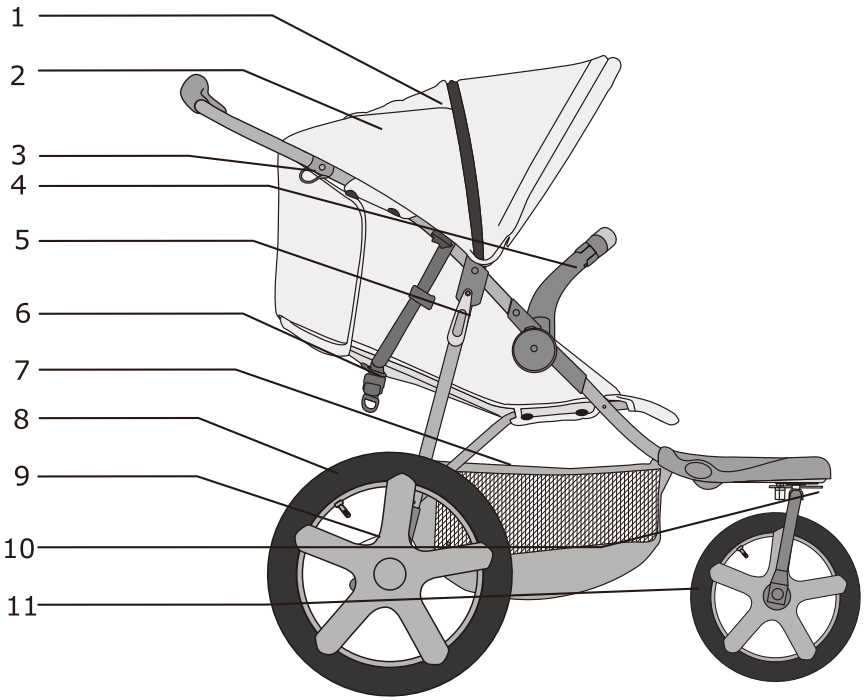

1. Peek-a-boo	7. Storage basket
2. Canopy	8. Rear wheel
3. Folding Button	9. Rear wheel brake pedal
4. <b>Bumper bar</b>	10. Front wheel locked button
5. Stroller folding clasp	11. Front wheel
6. Backrest webbing adjustment group	

**1. Stroller frame**

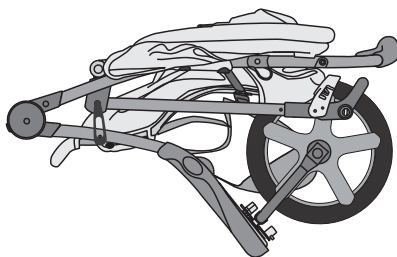

---

**2. Bumper bar**

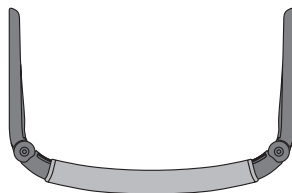

---

**3. Rear wheel group**

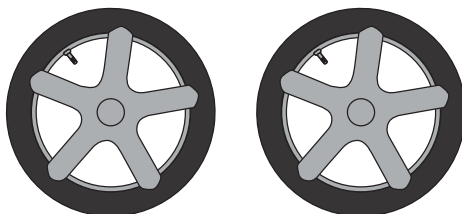

## **WARNING**

Read all instructions before use. Keep this manual for future reference.

Failure to follow instructions may result in property damage or injury. Do not leave children unattended.

- Not to be used by children over three years. Maximum load is 15kg.
- Before using, carefully check all locking devices to make sure they are properly locked.
- Do not fold the pushchair whilst a child is inside.
- A seatbelt must always be worn.
- Do not lift the pushchair by the front handrail - it could fall off and cause an injury. Do not leave the pushchair on a slope.
- The maximum load of the storage basket is 3kg.
- Do not hang items on the handlebars in case the stroller tips over.
- Do not disassemble or adjust any parts of the stroller while a child is in it.
- Keep plastic bags and other materials away from the side of the stroller - children could suffocate.

## **WARNING**

**FOLLOW THE MANUFACTURER'S INSTRUCTIONS.**

**USE BRAKES WHENEVER YOU PARK THE PUSHCHAIR.**

**DO NOT LEAVE CHILDREN UNATTENDED.**

**DO NOT CARRY EXTRA CHILDREN OR BAGS ON THIS PUSHCHAIR.**

**MAKE SURE CHILDREN ARE CLEAR OF ANY MOVING PARTS IF YOU ADJUST THE STROLLER. OTHERWISE THEY COULD GET INJURED.**

## **WARNING**

**USE THIS HARNESS AT ALL TIMES.**



# **WARNING**

**USE THE BRAKE TO STOP THE PUSHCHAIR ROLLING AWAY.**

## **CARE AND MAINTENANCE**

- Please clean with a non-toxic and non-corrosive cleaner. Mix water and a small amount of mild, non-toxic detergent into a solution and wipe the frame with a damp cloth. Do not use corrosive cleaners or solutions.
- Do not store in humid or high temperature places - rust and damages to parts could occur. Keep in a properly ventilated and dust-free area.
- Regularly check for loose screws and damages to parts. If any damages are found, do not use this product.
- Follow all instructions when assembling and disassembling to avoid damage.
- **WARNING** Never leave the child unattended.
- **WARNING** Ensure that all the locking devices are engaged before use.
- **WARNING** To avoid injury ensure that the child is kept away when unfolding and folding this product.
- **WARNING** Do not let the child play with this product"-
- For pram bodies having a length greater than 800 mm: **WARNING**
- Use a harness as soon as the child can sit unaided.
- If applicable: "WARNING This seat unit is not suitable for children under 6 months"
- If applicable "WARNING Always use the restraint system
- **WARNING** Check that the pram body or seat unit or car seat attachment devices are correctly engaged before use.
- Only replacement parts supplied or recommended by the manufacturer/distributor shall be used.
- **WARNING** This product is not suitable for running or skating.

# Instructions

## Unfolding the pushchair

1. Remove the product from its packaging, put the wheels and other parts of the pushchair to the side, and prepare the stroller for installation (see the picture below).
2. As shown in the picture, pull the folding clasp outward (1)- at the same time, hold the handlebar with your hand and lift up slightly (2). The clasp will disengage from the fixing bolt, then fully expand the pushchair in the direction shown in the figure (3).

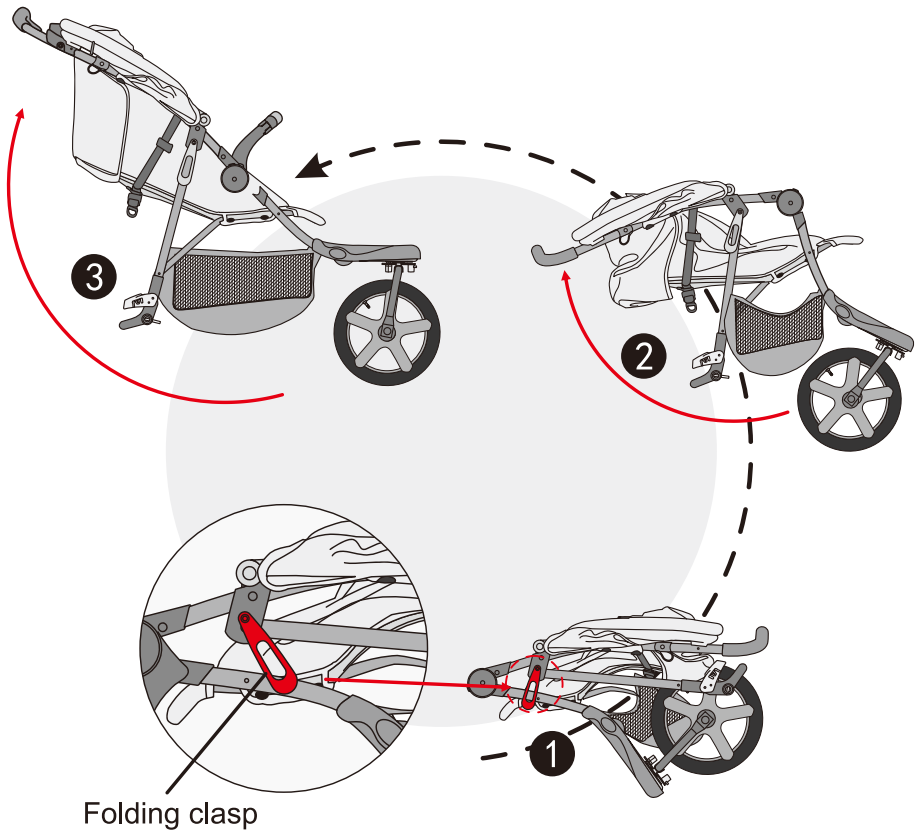

## Assembly and disassembly of Rear Wheel

1. Assembly of Rear Wheel: Insert the axle of the rear wheel set into the hole of the centre sleeve of the rear wheel. When you hear them 'clicking' together, pull the wheel in the opposite direction to ensure it is properly in place. Follow the same steps for the other wheel.
2. Quick Disassembly of Rear Wheel: Press and hold the button as shown, then pull the rear wheel out of the centre sleeve.

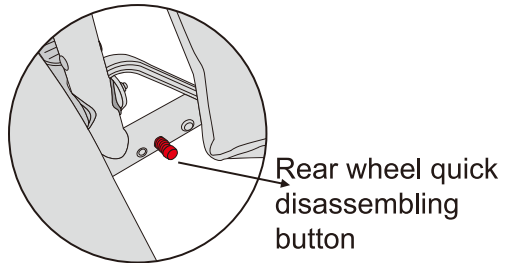
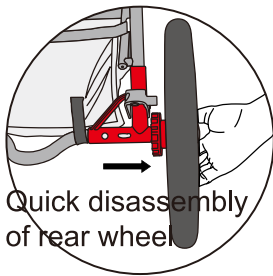
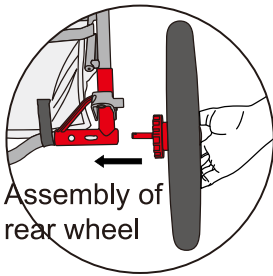

## Using a Safety Belt

1. Fasten the buckle with the latch plate, then place the combined latch plate into the centre of the buckle. Use these steps for the other side.
2. To remove the buckle, press the oval button in the centre.

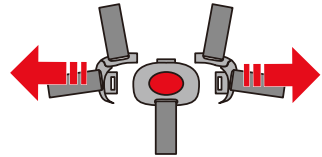
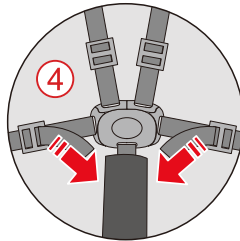
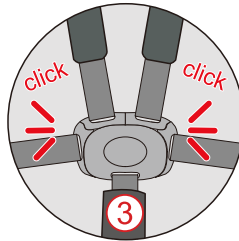
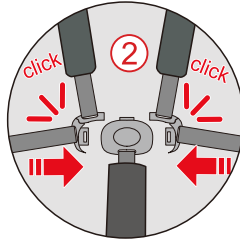
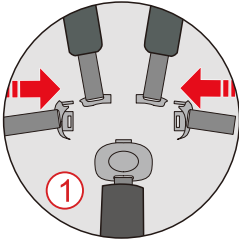

## Use of Rear Wheels Brake

Use of rear wheels brake: Press the brake pedal of the rear wheel to brake. Lift the pedal to unlock.

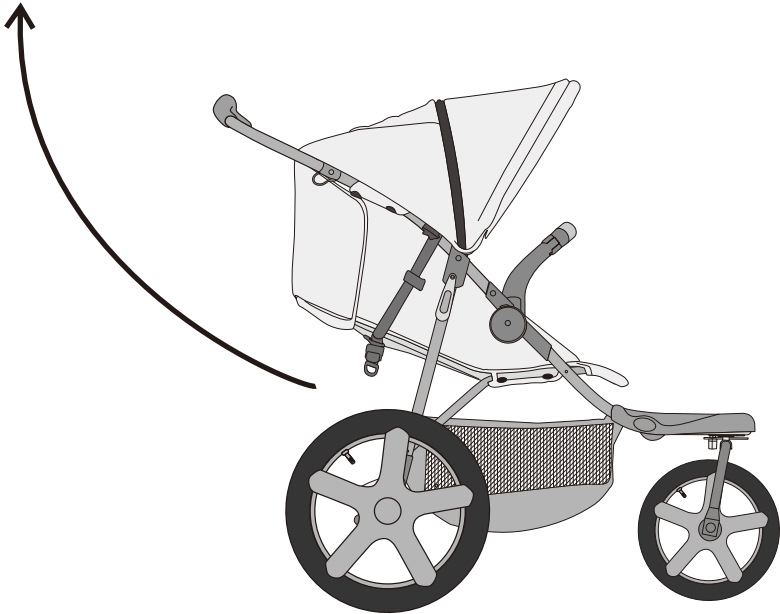
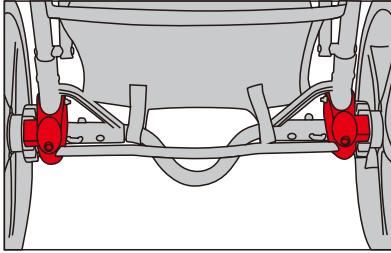

## Locked and Universal Front Wheel

When the dial button in front of the front wheel is pushed upward, the front wheel moves in a straight line. When pushing down the button, the pushchair can rotate and turn.

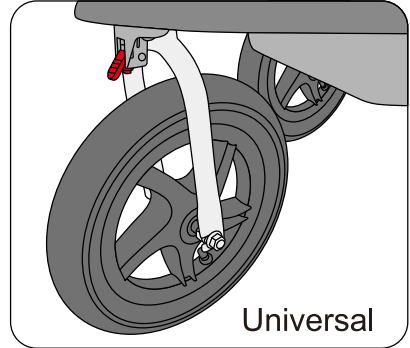
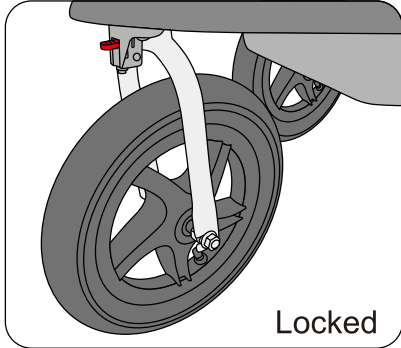

## Backrest Adjustment

1. Hold the clip at the on the back of the belt, which is on the back of the pushchair, then push the adjusting plastic part of the back up and tighten the belt until the backrest is vertical.
2. Hold the clip at the end of the belt and hold down the two buttons on the back to adjust the plastic part. Then, pull down the plastic part and loosen the belt until the backrest becomes horizontal.

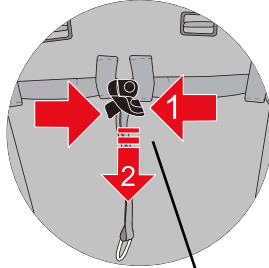

Backrest adjustment plastic part

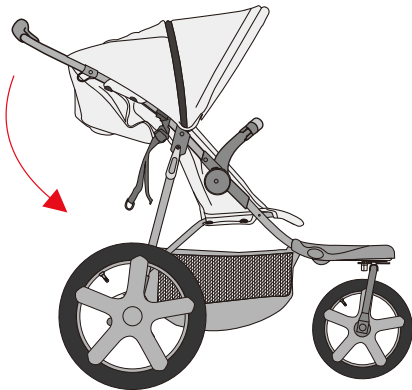

Clip

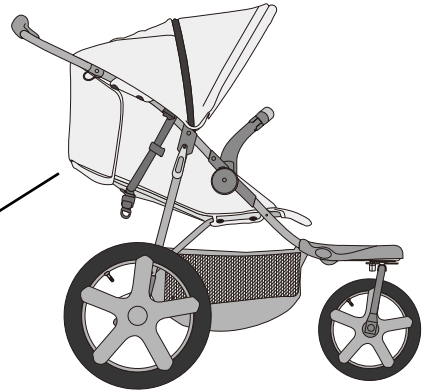

## Folding the pushchair

1. Fold the top canopy.
2. Pull up folding locks on both sides of the handlebar.
3. At the same time, press down on the handlebar and fold the pushchair (see picture below).
4. Finally, buckle and fasten the folding clasp.

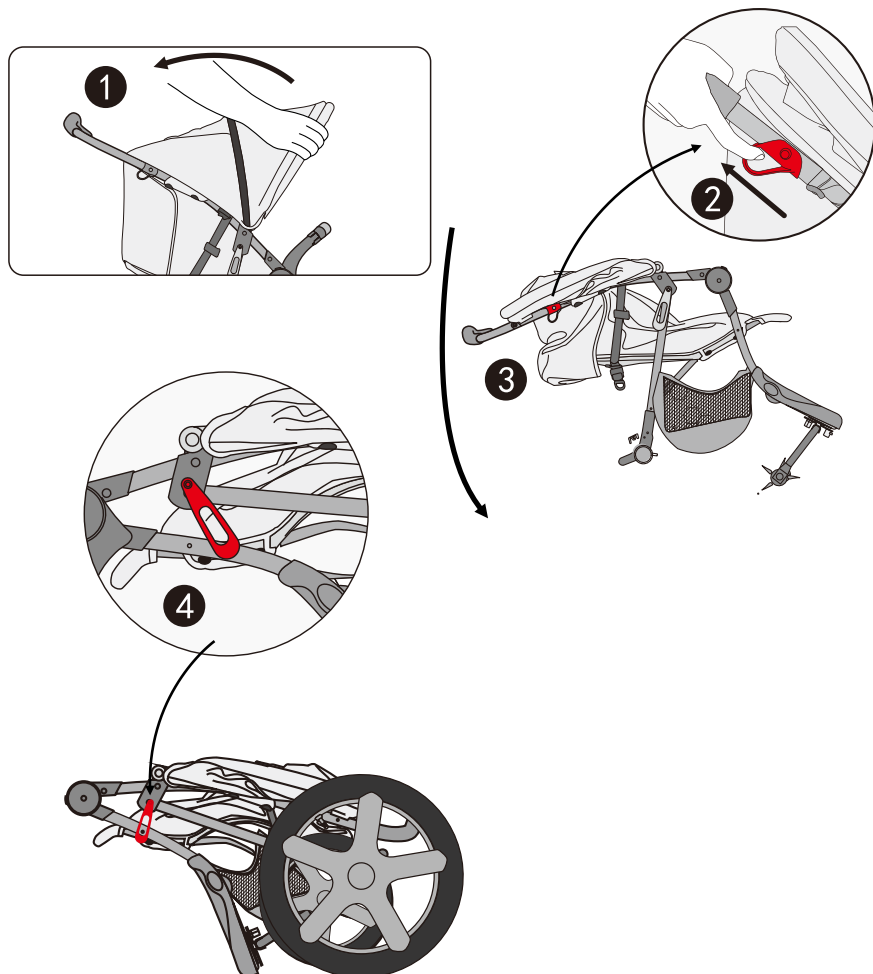



# PARTI

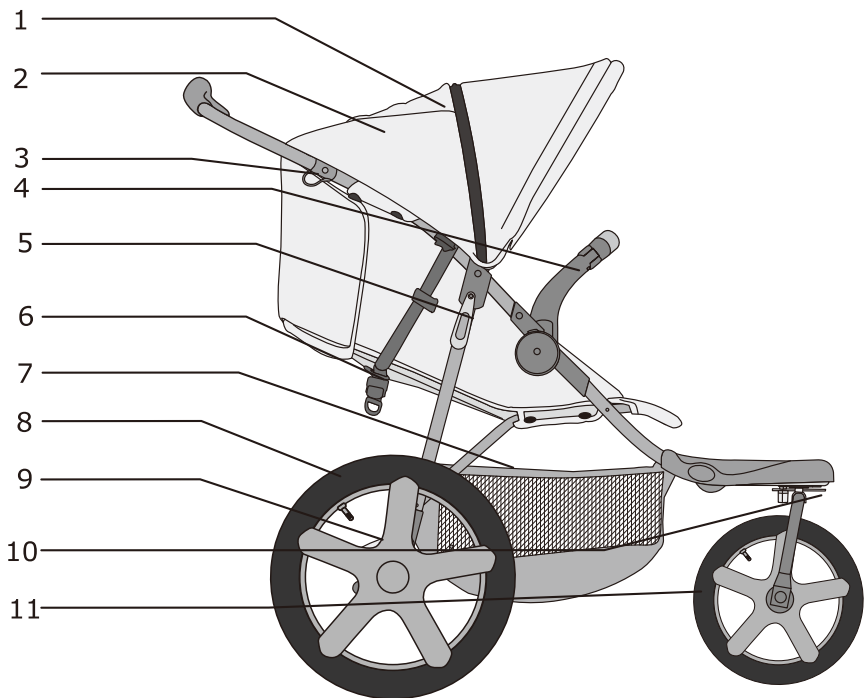

1. Sbirciatina	7. Cesto per stoccaggio
2. Cappottina	8. Ruota posteriore
3. Pulsante Piegatura	9. Pedale del freno della Ruota posteriore
4. Barra paraurti	10. Pedale del freno della Ruota anteriore
5. Chiusura per piegare passeggino	11. Ruota anteriore
6. Gruppo regolazione cinghie schienale	

## 1. Telaio del passeggero

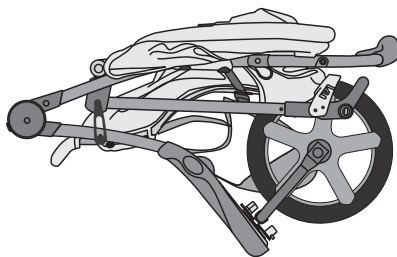

---

## 2. Bracciolo

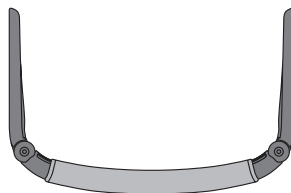

---

## 3. Ruota posteriore group

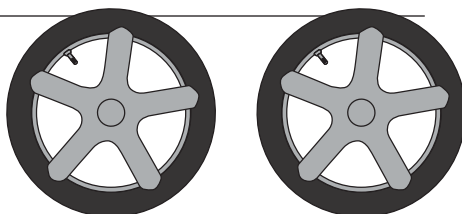

## **AVVERTIMENTO**

**UTILIZZARE SEMPRE QUESTA CINTURA DI SICUREZZA.**

## **AVVERTIMENTO**

**UTILIZZARE IL FRENO PER FERMARE IL PASSEGGINO DAL MOVIMENTO.**

## **CURA E MANUTENZIONE**

- Si prega di pulire con un detergente non tossico e non corrosivo. Mescolare acqua e una piccola quantità di detergente delicato e non tossico in una soluzione e pulire il telaio con un panno umido. Non utilizzare detergenti o soluzioni corrosive.
- Non conservare in luoghi umidi o ad alta temperatura - potrebbero verificarsi ruggine e danni alle parti. Conservare in un luogo adeguatamente ventilato e privo di polvere.
- Controllare regolarmente la presenza di viti allentate e danni alle parti. Se si trovano i danni, non utilizzare questo prodotto.
- Seguire tutte le istruzioni durante il montaggio e lo smontaggio per evitare danni.
- Attenzione non lasciare mai il bambino incustodito.
- Avvertenza assicurarsi che tutti i dispositivi di bloccaggio siano accesi prima dell'uso.
- Avvertenza per evitare lesioni assicurarsi che il bambino sia tenuto lontano durante lo svolgimento e la piegatura del prodotto.
- Avvertenza non lasciare che il bambino giochi con questo prodotto
- Per i corpi delle carrozzine di lunghezza superiore a 800 mm: avvertenza usare una bretella non appena il bambino può stare seduto da solo.
- Se del caso: "avvertenza: questa unità del sedile non è adatta per bambini di età inferiore a 6 mesi"
- Se del caso, usare sempre il sistema di ritenuta
- Verificare che la carrozzeria della carrozzina, l'unità del sedile o i dispositivi di fissaggio del sedile siano correttamente agganciati prima dell'uso.
- Devono essere utilizzate solo le parti di ricambio fornite o raccomandate dal fabbricante/distributore.
- Avvertenza questo prodotto non è adatto alla marcia o al pattinamento.

# Istruzioni

## Aprire il passeggino

1. Estrarre il prodotto dalla confezione, mettere da parte le ruote e le altre parti del passeggino e preparare il passeggino per l'assemblaggio (vedi figura sotto).
2. Come mostrato in figura, tirare la chiusura per piegatura verso l'esterno (1) - allo stesso tempo, tenere il manubrio con la mano e sollevarlo leggermente (2). La chiusura si disimpegnerà dal bullone di fissaggio, quindi espanderà completamente il passeggino nella direzione mostrata nella figura (3).

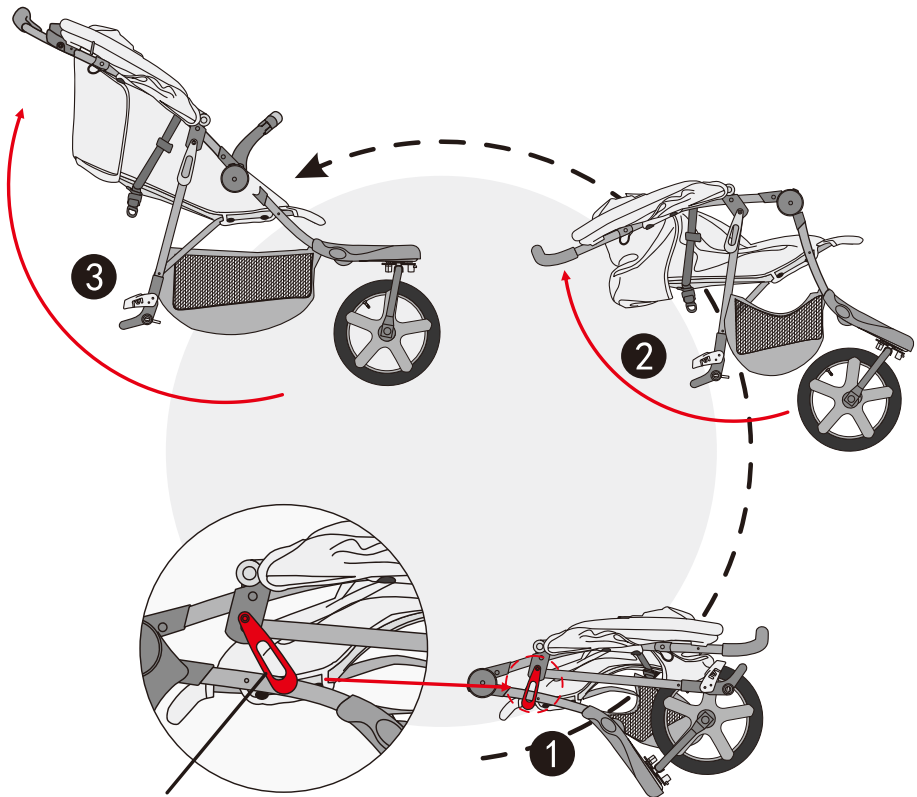

Chiusura per piegatura

## Montaggio e smontaggio delle Ruote posteriori

1. Montaggio della Ruota Posteriore: Inserire l'asse del gruppo della ruota posteriore nel foro del manicotto centrale della Ruota Posteriore. Quando li senti "clic" insieme, tirare la ruota nella direzione opposta per assicurarti che sia correttamente in posizione. Seguire gli stessi passaggi per l'altra ruota.
2. Smontaggio rapido della Ruota posteriore: premere e tenere premuto il pulsante come mostrato, e poi estrarre la Ruota posteriore dal manicotto centrale.

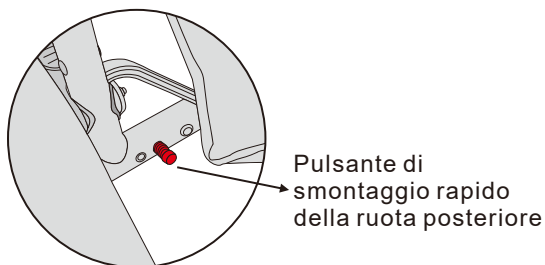
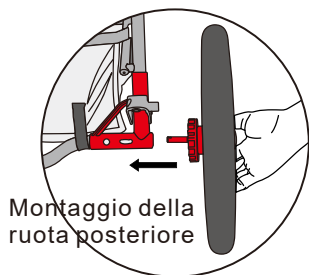

## Utilizzo di una Cintura di Sicurezza

1. Fissare la fibbia con la piastra di chiusura, quindi posizionare la piastra di chiusura combinata al centro della fibbia. Utilizzare questi passaggi per l'altro lato.
2. Per rimuovere la fibbia, premere il pulsante ovale al centro.

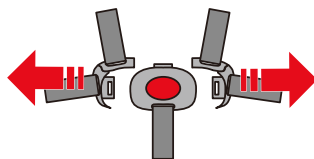
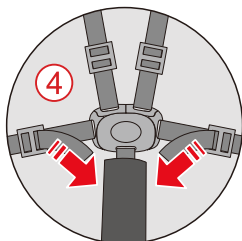
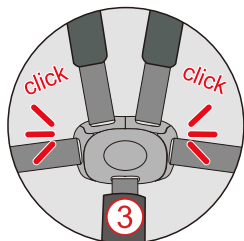
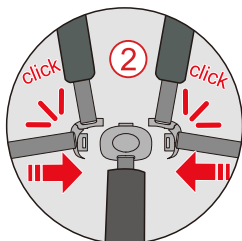
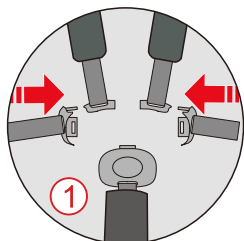

## Utilizzo del Freno della Ruota Posteriore

Utilizzo del freno della ruota posteriore: Premere il pedale del freno della ruota posteriore per frenare. Sollevare il pedale per sbloccare.

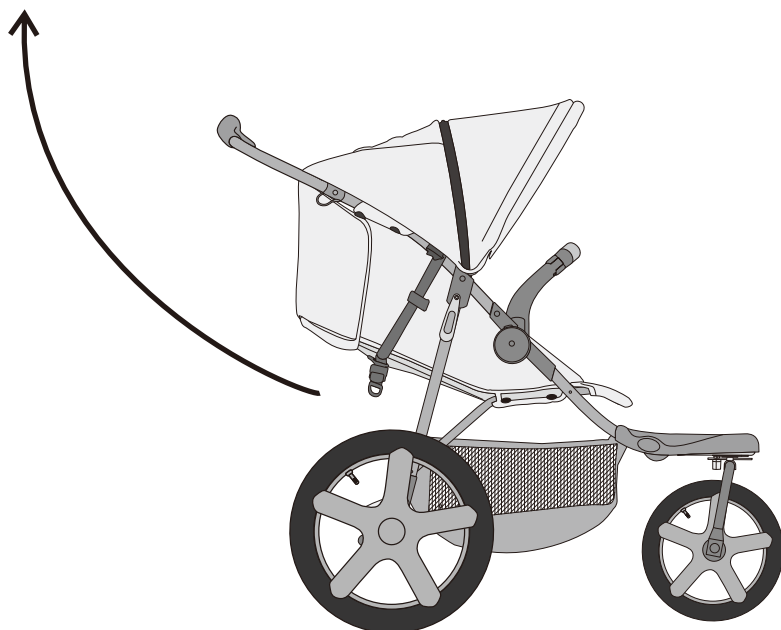
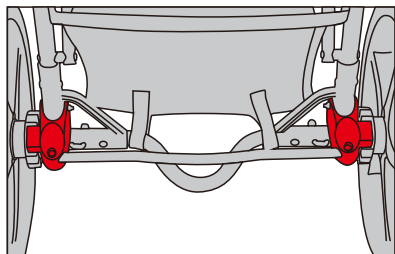

## Ruota Anteriore Bloccata e Universale

Quando il pulsante di selezione davanti alla ruota anteriore viene premuto verso l'alto, la ruota anteriore si muove in linea retta. Quando si preme il pulsante, il passeggino può ruotare e girare.

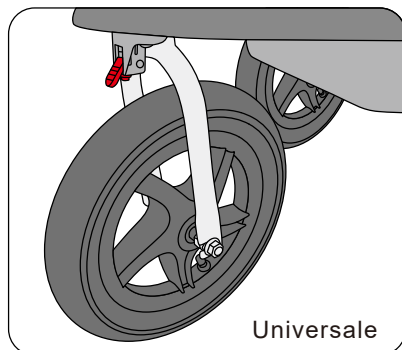
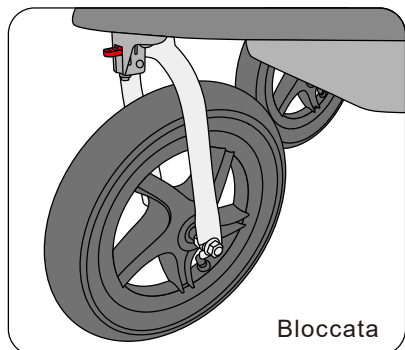



## Regolazione dello Schienale

1. Tenere la graffetta sul retro della cintura che si trova sul retro del passeggino, e poi spingere verso l'alto la parte in plastica di regolazione dello schienale e stringere la cintura fino a quando lo schienale è verticale.
2. Tenere la graffetta all'estremità della cintura e tenere premuti i due pulsanti sul retro per regolare la parte in plastica. E poi abbassare la parte in plastica e allentare la cintura fino a quando lo schienale diventa orizzontale.

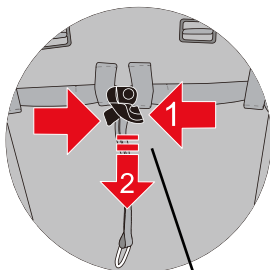

Parte in plastica per  
regolazione dello schienale

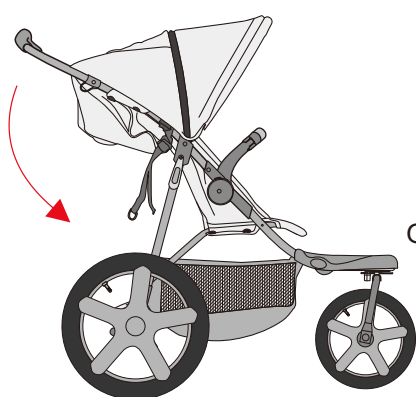

Graffetta

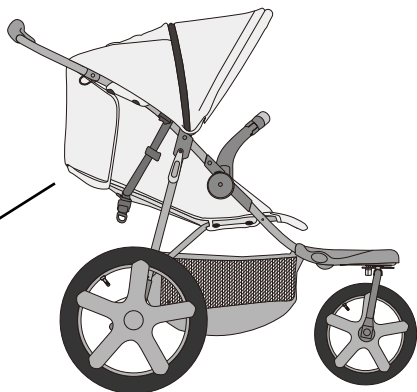

## Piegatura del Passeggino

1. Piegare la cappottina superiore.
2. Sollevare i fermi pieghevoli su entrambi i lati del manubrio.
3. Allo stesso tempo, premere sul manubrio e piegare il passeggino (vedi figura sotto).
4. Infine, allacciare e fissare la chiusura per piegatura.

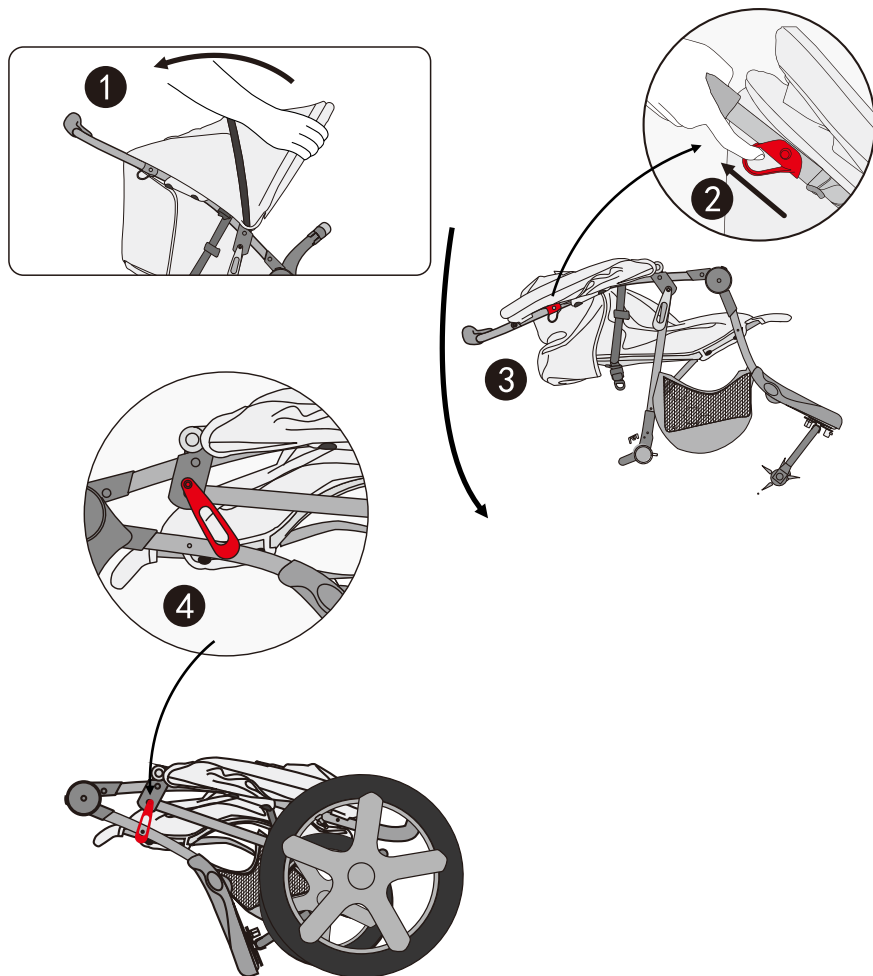

**UK**

If you have any questions, please contact our customer care center.

Our contact details are below:



0044-800-240-4004



[enquiries@mhstar.co.uk](mailto:enquiries@mhstar.co.uk)

IMPORTER ADDRESS:

MH STAR UK LTD  
Unit 27, Perivale Park,  
Horsenden lane South  
Perivale, UB6 7RH  
MADE IN CHINA

**IT**

In caso di dubbio, si prega di contattare il nostro centro assistenza clienti.

I nostri dettagli di contatto sono di seguito:



0039-0249471447



[clienti@aosom.it](mailto:clienti@aosom.it)

IMPORTATO DA:

AOSOM Italy srl  
Centro Direzionale Milanofiori  
Strada 1 Palazzo F1  
20057 Assago (MI)  
P.I.: 08567220960  
FATTO IN CINA