

Vinsetto

IN220800575V02_GL

921-175_921-175V71



EN_IMPORTANT, RETAIN FOR FUTURE REFERENCE: READ CAREFULLY.

FR_IMPORTANT: A LIRE ATTENTIVEMENT ET À CONSERVER POUR CONSULTATION ULTÉRIEURE.

ES_IMPORTANTE, LEA Y GUARDE PARA FUTURAS REFERENCIAS.

PT_IMPORTANTE, RETER PARA REFERÊNCIA FUTURA: LEIA ATENTAMENTE.

DE_WICHTIG! SORGFÄLTIG LESEN UND FÜR SPÄTER NACHSCHLAGEN AUFBEWAHREN.

IT_IMPORTANTE! CONSERVARE IL PRESENTE MANUALE PER FUTURO RIFERIMENTO E LEGGERLO ATTENTAMENTE.

IMPORTANT, RETAIN FOR FUTURE REFERENCE: READ CAREFULLY.

SAFETY INFORMATION

- The intended use: This product is intended for indoor use only.
Used for work and study.
- Maximum weight: **120 KG**
- To prevent the chair falling, make sure that the weight is evenly distributed.
- Remove all parts from the box and make sure all parts are included before assembly.
- Keep your feet always on the floor and do not press your head on the headrest when you recline the chair.
- When you adjust the backrest, make sure your fingers are safe and out of harm's way.
- To avoid damage, never pull fast and strongly in your house.
- This chair is designed to sit only and nothing else.
- Don't use it as a base or as a ladder.
- Don't sit in the arms of the chair.
- This chair is designed to seat only one person at same time.
- If some parts are missing, damaged or worn, stop using it immediately.
- Avoid direct sunlight on the chair so that the plastic components won't become brittle.

Warning! Only trained personnel may replace or repair components for height adjustment of seating furniture with energy storage.

MAINTENANCE INSTRUCTIONS

- Clean with vacuum cleaner.
- Wipe with a fabric dampened with water.

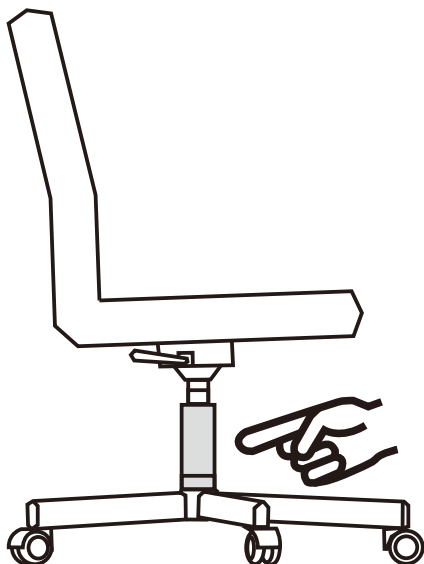

IMPORTANT: A LIRE ATTENTIVEMENT ET À CONSERVER POUR CONSULTATION ULTÉRIEURE.

INFORMATIONS SUR LA SÉCURITÉ

- Utilisation recommandée : Le produit est destiné à un usage exclusivement en intérieur. Pour le travail et les études.
- Poids maximum: **120** kg
- Pour éviter que le fauteuil ne tombe, assurez-vous que le poids est réparti uniformément.
- Retirez toutes les pièces de la boîte et assurez-vous que toutes les pièces sont incluses avant l'assemblage.
- Gardez toujours les pieds sur le sol et n'appuyez pas votre tête sur l'appui-tête lorsque vous inclinez le fauteuil.
- Lorsque vous ajustez le dossier, assurez-vous que vos doigts sont en sécurité et hors de danger.
- Pour éviter tout dommage, ne tirez jamais vite et fort dans votre maison.
- Cette chaise est conçue pour s'asseoir uniquement et rien d'autre.
- Ne l'utilisez pas comme base ou comme échelle.
- Ne vous asseyez pas sur les accoudoirs de la chaise.
- Cette chaise est conçue pour accueillir une seule personne à la fois.
- Si certaines pièces manquent, sont endommagées ou usées, arrêtez de les utiliser immédiatement.
- Éviter les rayons directs du soleil sur le fauteuil afin que les pièces en plastique ne deviennent pas fragiles.

Attention! Le remplacement et la réparation des pièces pour le réglage de la hauteur du fauteuil avec accumulateurs d'énergie ne doivent être effectués que par du personnel qualifié.

CONSIGNES D'ENTRETIEN

- Nettoyer avec un aspirateur.
- Essuyez avec un tissu humidifié avec de l'eau.

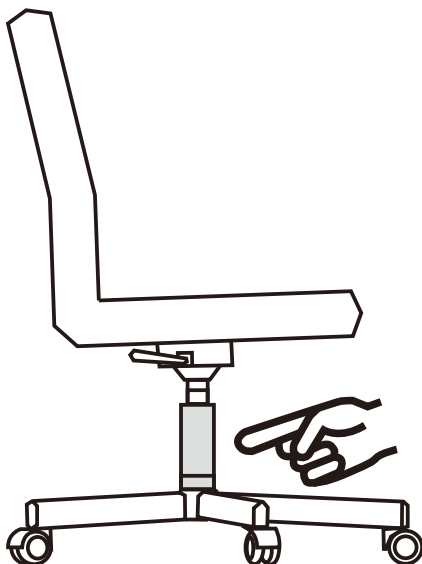

IMPORTANTE, LEA Y GUARDE PARA FUTURAS REFERENCIAS.

INFORMACIÓN DE SEGURIDAD

- Uso previsto: Este producto está diseñado para ser utilizado en interiores solamente. Se puede utilizar para trabajar y estudiar
- Peso máximo soportado: **120** kg
- Para evitar que la silla caiga, asegúrese de que el peso sea uniformemente distribuido.
- Saque todas las piezas de la caja y asegúrese de que todas las piezas estén incluidas antes del montaje.
- Mantenga los pies siempre en el suelo y no haga presión con la cabeza sobre el reposacabezas al reclinar la silla.
- Cuando ajuste el respaldo, asegúrese de que sus dedos están seguros y fuera de peligro.
- Para evitar daños, nunca a tire rápido y fuerte de las cascas.
- Esta silla está diseñada para sentarse solamente y nada más.
- No la utilice como base o como escalera.
- No se sienten en los brazos de la silla.
- Esta silla está diseñada para sentar una persona a la vez.
- Si faltan algunas piezas, están dañadas o desgastadas, deje de usarla inmediatamente.
- Evite la luz solar directa sobre la silla para que los componentes de plástico no se vuelvan frágiles.

iAdvertencia! La sustitución y la reparación de los componentes para la regulación de la altura de la silla con acumuladores de energía deben ser efectuados solo por personal cualificado.

INSTRUCCIONES DE MANTENIMIENTO.

- Limpiar con aspiradora.
- Limpiar con un paño humedecido en agua.

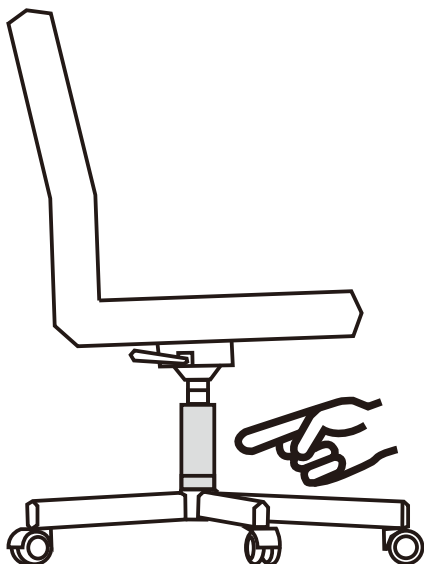

IMPORTANTE, RETER PARA REFERÊNCIA FUTURA: LEIA ATENTAMENTE.

INFORMAÇÃO DE SEGURANÇA

- Uso previsto: Este produto está especialmente desenhado para ser usado somente em espaços interiores.
- Peso máximo suportado: **120 kg**
- Coloque o produto sobre um solo plano e estável.
- Mantenha-o afastado de fontes de calor e chamas.
- Prepare a zona de montagem. Certifique-se de que esteja limpa e seca.
- Certifique-se que o produto esteja em bom estado.
- Verifique que não falte nenhuma das peças.
- Esta cadeira está desenhada somente para sentar, não a use como base ou escada.
- Somente pode sentar-se uma pessoa por vez.
- Caso detecte que faltam peças, estejam danificadas ou desgastadas, não use o produto até solucionar o problema.
- A fim de evitar a fragilidade dos componentes plásticos, evite a exposição solar direta sobre a cadeira.

Recomendações de uso:

- Certifique-se de que o peso esteja distribuído de forma uniforme a fim de evitar caídas.
- Mantenha os pés sempre no solo e não faça pressão com a cabeça ao reclinar a cadeira.
- Quando ajustar o encosto, certifique-se de que não enganchar os dedos.

Manutenção:

- Limpar com um aspirador.
- Limpar o produto com a ajuda de um pano úmido.
- Inspeccionar o produto de forma regular a fim de detectar possíveis defeitos que possam afetar seu uso.

Condições de armazenamento:

- A fim de evitar a aparecimento de mofo, os tecidos se devem guardar totalmente secos e em um lugar limpo e sem umidade.

Advertencia! Se o produto estiver equipado com algum mecanismo elétrico de ajuste de altura ou similar, somente poderá ser substituído ou reparado por uma pessoa qualificada.

Atenção: Risco de cortes durante a montagem. O fabricante declina toda responsabilidade no caso de deterioração devido uma má instalação.

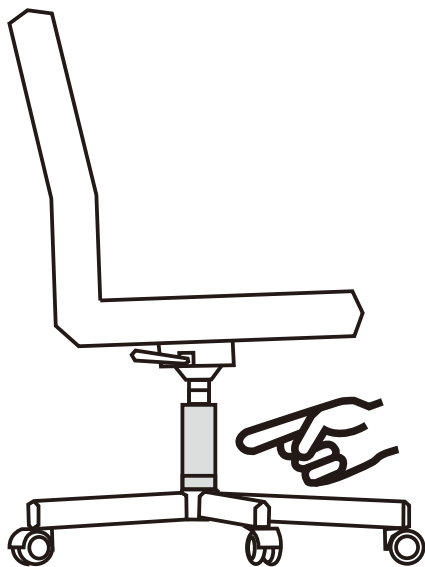

WICHTIG! SORGFÄLTIG LESEN UND FÜR SPÄTER NACHSCHLAGEN AUFBEWAHREN.

SICHERHEITSINFORMATIONEN

- Die vorgesehene Verwendung: Dieses Produkt ist nur für die Verwendung in Innenräumen bestimmt. Zur Verwendung für Arbeit und Studium
- Maximalgewicht: **120** kg
- Achten Sie auf eine gleichmäßige Gewichtsverteilung, um Schäden am Stuhl zu verhindern.
- Nehmen Sie vor Beginn der Montage zunächst alle Teile aus dem Karton und vergewissern Sie sich, dass alle Zubehörteile enthalten sind.
- Bitte lassen Sie Ihre Füße immer auf dem Boden und drücken Sie Ihren Kopf nicht gegen die Kopfstütze, wenn Sie den Stuhl zurücklehnen.
- Achten Sie beim Verstellen der Rückenlehne darauf, dass Ihre Finger sicher und nicht in Gefahr sind.
- Um Schäden zu vermeiden, ziehen Sie niemals schnell und fest an dem Stuhl.
- Dieser Stuhl ist nur zum Sitzen und für nichts anderes vorgesehen.
- Verwenden Sie den Stuhl nicht als Untergestell oder Leiter.
- Setzen Sie sich nicht auf die Armlehnen des Stuhls.
- Dieser Stuhl ist so konzipiert, dass jeweils nur eine Person darauf sitzen kann.
- Falls Teile fehlen, beschädigt oder abgenutzt sind melden Sie sich bei unseren Kundenservice.
- Bitte vermeiden Sie direktes Sonnenlicht auf dem Stuhl, um ein Verspröden der Kunststoffteile zu vermeiden.

Warnung! Der Austausch und die Reparatur von Zubehörteilen zur Einstellung der Stuhlhöhe darf nur von qualifiziertem Fachpersonal durchgeführt werden.

WARTUNGSANLEITUNG

- Reinigen Sie diesen Stuhl mit einem Staubsauger.
- Wischen Sie diesen Stuhl mit einem feuchten Tuch ab.

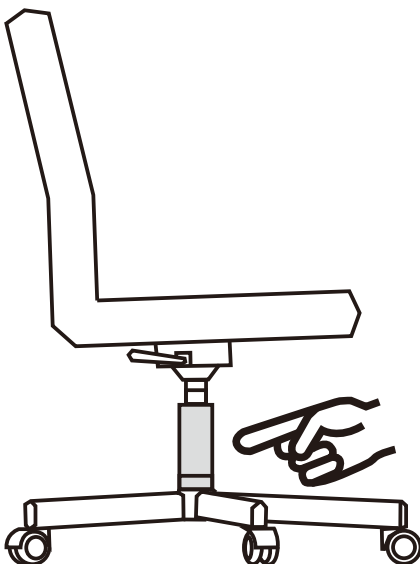

IMPORTANTE! CONSERVARE IL PRESENTE MANUALE PER FUTURO RIFERIMENTO E LEGGERLO ATTENTAMENTE.

INFORMAZIONI DI SICUREZZA

- Scopo d'uso: questo prodotto e' progettato solo per uso domestico. Va usato per lavoro o per studio.
- Peso massimo: **120 KG**
- Per prevenire che la sedia cada, assicurarsi che il peso sia distribuito omogeneamente.
- Rimuovere tutte le parti dalla confezione e assicurarsi che nessuna manchi prima del montaggio.
- Tenere sempre i piedi sul pavimento e non premere la testa sul poggiatesta quando reclinate la sedia.
- Quando regolate lo schienale, assicuratevi di non farvi male alle dita in alcun modo.
- Per evitare danni, non spingere mai velocemente e con forza all'interno della vostra abitazione.
- Questa sedia e' progettata solo per sedervi sopra e per nessun altro scopo.
- Non usare come base o come scala.
- Non sedersi sui poggiaabbraccia della sedie.
- Questa sedia e' progettata perche' vi si sieda una persona alla volta.
- Se alcune parti mancano, sono danneggiate o usurate, smettere di usare immediatamente.
- Evitare la luce solare diretta sulla sedia di modo che i componenti in plastica non si sfibrino.

Avvertenza! La sostituzione e la riparazione di componenti per la regolazione dell'altezza della sedia con un sistema di propulsione va eseguita solo da personale qualificato.

ISTRUZIONI PER LA MANUTENZIONE

- Pulire con l'aspirapolvere
- Passare un panno inumidito con acqua.

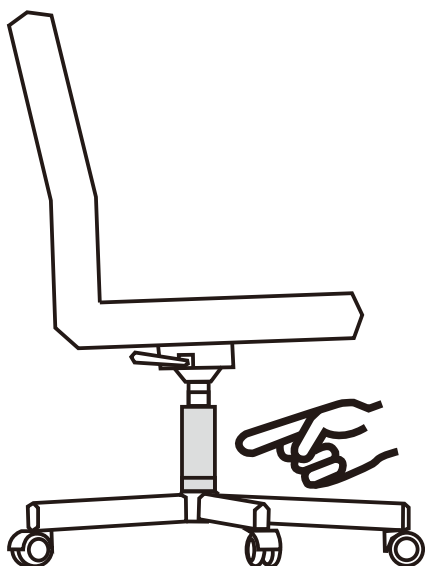

PARTS

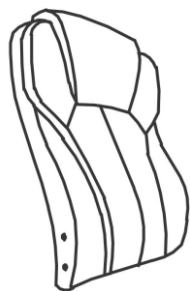

A x 1



B x 1

R



C x 2

L

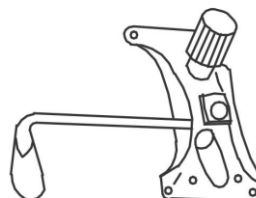

D x 1

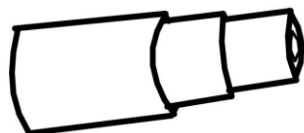

E x 1

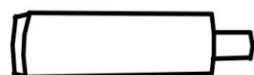

F x 1



G x 1



H x 5

HARDWARE



I x 4
M6*20



J x 8
M6*30



K x 8



L x 1

E x 1

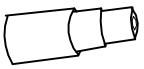

F x 1

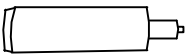

G x 1



H x 5

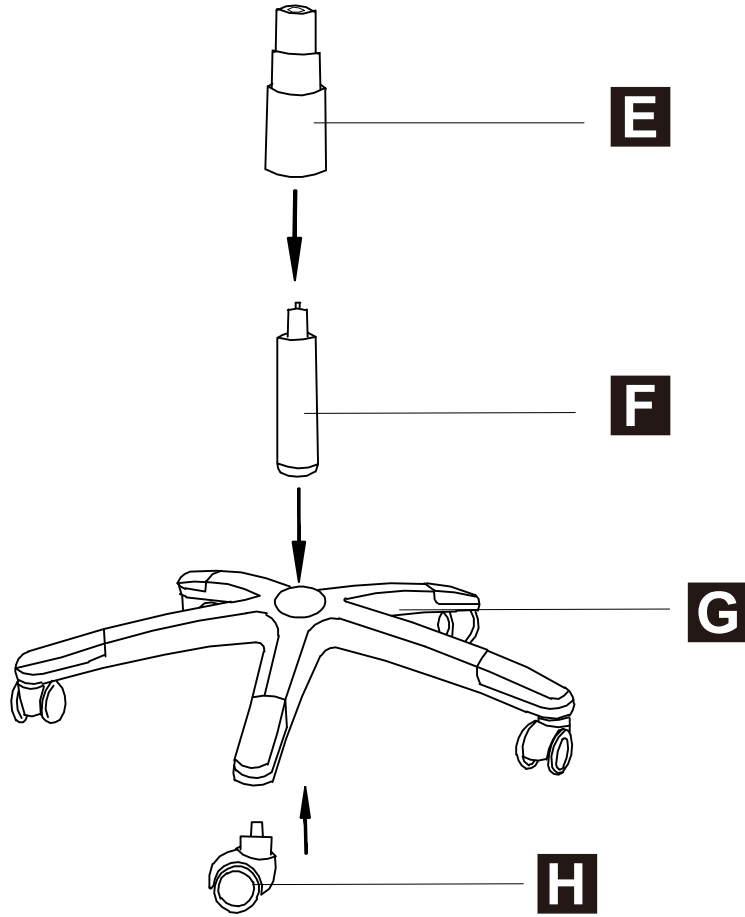

B x 1



D x 1

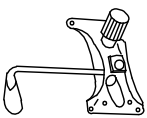

I x 4

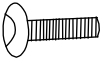

M6*20

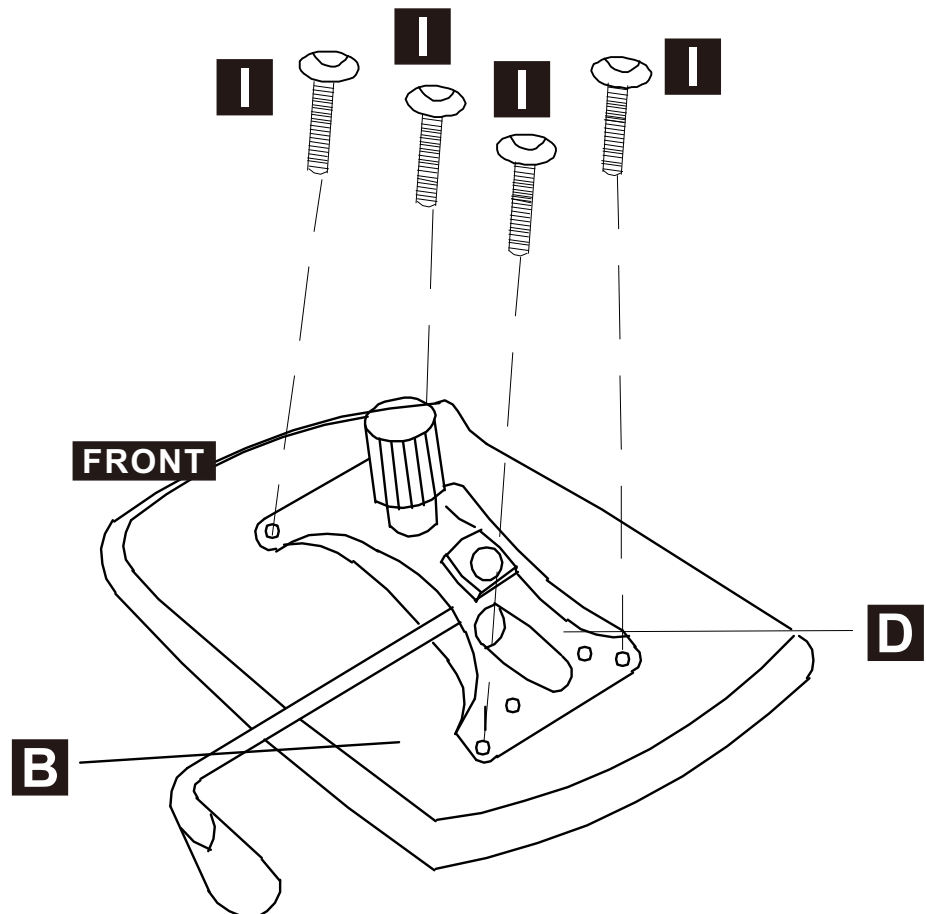



A x 1

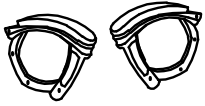

C x 2



J x 8

M6*30



K x 8

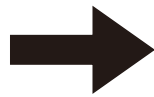
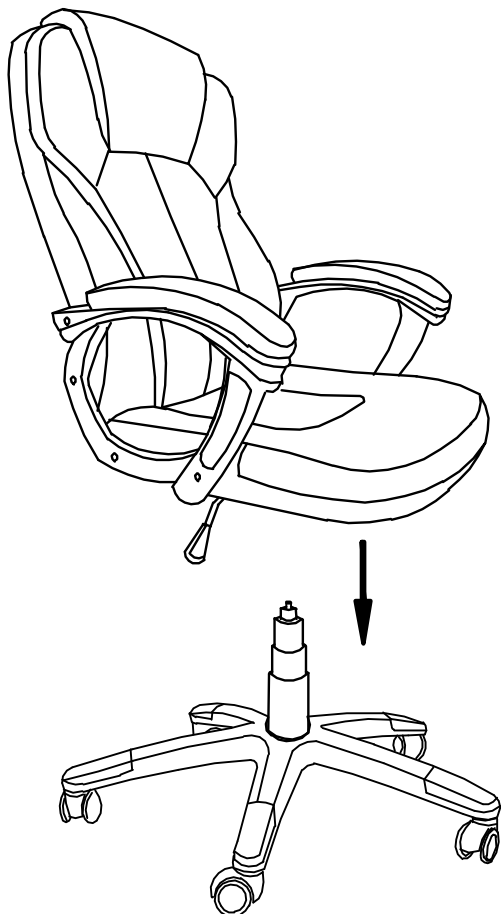
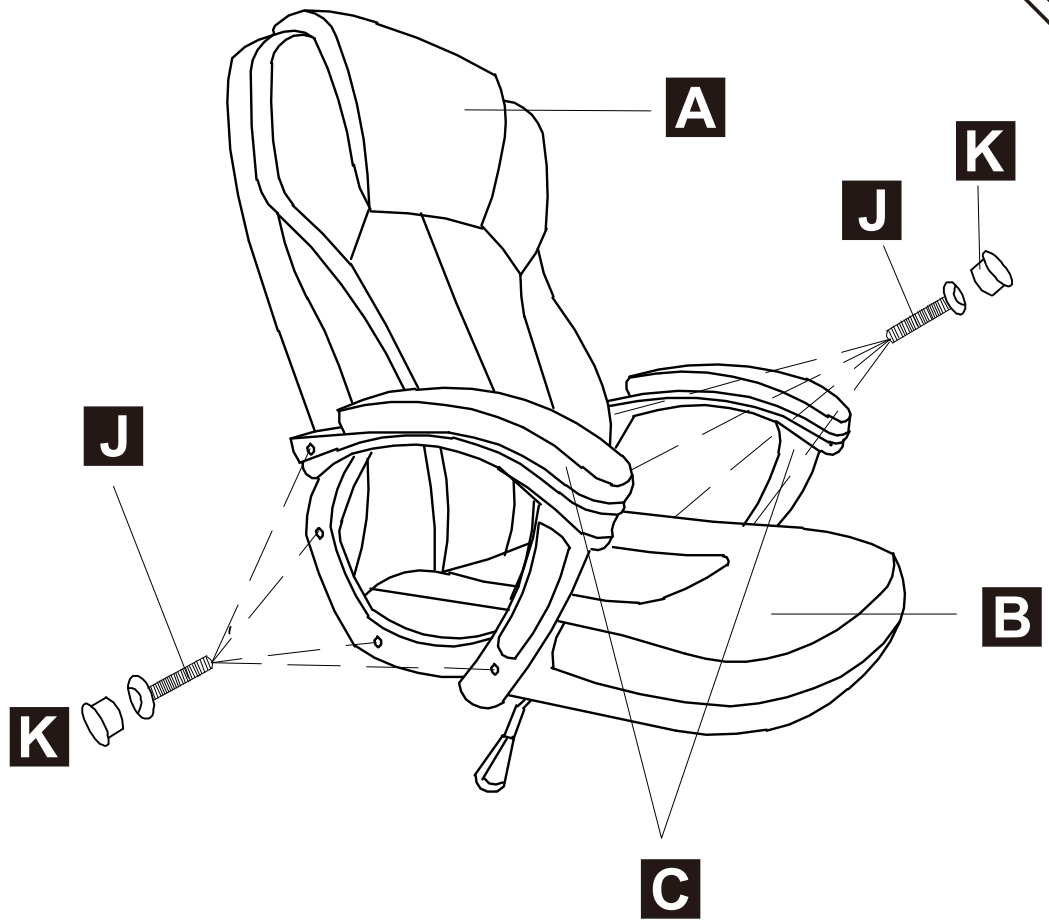

If you have any questions, please contact our customer care center, Our contact details are below:

US

 001-877-644-9366

 customerservice@aosom.com

Imported by Aosom LLC
27150 SW Kinsman Rd Wilsonville, OR 97070 USA
MADE IN CHINA

If you have any questions, please contact our customer care center, Our contact details are below:

CA

 416-792-6088

 customerservice@aosom.ca

Imported by Aosom Canada Inc.
7270 Woodbine Avenue, Unit 307, Markham,
Ontario Canada L3R 4B9
MADE IN CHINA

Si vous avez la moindre question, veuillez contacter notre centre d'assistance à la clientèle, Nos coordonnées sont les suivantes:

 416-792-6088

 customerservice@aosom.ca

Importé par Aosom Canada Inc.
7270 Woodbine Avenue, unité 307,
Markham, Ontario Canada L3R 4B9
FABRIQUÉ EN CHINE

If you have any questions, please contact our customer care center, Our contact details are below:

UK

 0044-800-240-4004

 enquiries@mhstar.co.uk

IMPORTER ADDRESS:
MH STAR UK LTD
Unit 27, Perivale Park,
Horsenden lane South
Perivale, UB6 7RH
MADE IN CHINA

Si vous avez la moindre question, veuillez contacter notre centre d'assistance à la clientèle, Nos coordonnées sont les suivantes:

FR

 0033-1-84166106

 aosom@mhfrance.fr

Importé par/Fabricant/REP:
MH FRANCE
2 Rue Maurice Hartmann
92130 Issy Les Moulineaux
France
FABRIQUÉ EN CHINE

Wenn Sie Fragen haben, wenden Sie sich bitte an unser Kundendienstzentrum, Unsere Kontaktdaten stehen unten:

DE

 0049-0(40)-88307530

 service@aosom.de

ADRESSE DES IMPORTEURE/Hersteller/REP:
MH Handel GmbH
Wendenstraße 309
D-20537 Hamburg
Germany
IN CHINA HERGESTELLT

In caso di dubbio, si prega di contattare il nostro centro assistenza clienti, I nostri dettagli di contatto sono di seguito:

IT

 0039-0249471447

 clienti@aosom.it

IMPORTATO DA/Produttore/REP:
AOSOM Italy srl
Centro Direzionale Milanofiori
Strada 1 Palazzo F1
20057 Assago (MI)
P.I.: 08567220960
FATTO IN CINA

Si tiene alguna pregunta, comuníquese con nuestro Centro de Atención al Cliente, Nuestros datos de contacto son los siguientes:

ES

 0034-931294512

 atencioncliente@aosom.es

IMPORTADOR/Fabricante/REP:
SPANISH AOSOM, S.L.
C/ROC GROS, N°15.08550, ELS HOSTALET DE
BALENYÀ, SPAIN.
B66295775
HECHO EN CHINA

Se tiver alguma dúvida, por favor contacte o nosso Centro de Atendimento ao Cliente, Os nossos dados de contacto são os seguintes:

PT

 0034-931294512

 info@aosom.pt.

IMPORTADOR/Fabricante/REP:
SPANISH AOSOM, S.L.
C.ROC GROS N.15, 08550. ELS HOSTALET DE
BALENYÀ
FEITO NA CHINA



FR

**DONNEZ
OU
RECYCLEZ**



ASSOCIATION

OU



LIVRAISON

OU



DÉCHÈTERIE

Adresses sur quefairedemesdechets.fr