

EN_ IMPORTANT, RETAIN FOR FUTURE REFERENCE: READ CAREFULLY.

FR_ IMPORTANT: A LIRE ATTENTIVEMENT ET A CONSERVER POUR VOUS Y REFRERER ULTERIEUREMENT.

ES_ IMPORTANTE, LEA DETENIDAMENTE Y GUARDE PARA FUTURAS REFERENCIAS.

PT_ IMPORTANTE, GUARDE PARA FUTURA REFERÊNCIA, LEIA ATENTAMENTE.

DE_ WICHTIG! SORGFÄLTIG LESEN UND FÜR SPÄTER NACHSCHLAGEN AUFBEWAHREN.

IT_ IMPORTANTE, LEGGERE E CONSERVARE QUESTO MANUALE D'ISTRUZIONE PER UN USO FUTURO.

Specification

Model	B31-333
Max power	40W
Adapter input	220-240V/50Hz

CAUTION

- For indoor use only.
- Keep out of reach of children and animals.
- Do not use in the bathroom or damp places.
- Place the lamp on a flat surface and ensure it is placed away from any flammable materials.
- Before cleaning the lamp, ensure it is switched off.
- Before replacing the bulb, ensure the plug has been removed from the socket and the lamp has cooled down.
- Do not pull the plug out of the socket with wet hands.
- If the supply cord is damaged it must only be replaced by a qualified engineer.
- Do not touch light bulb while fixture is turned on.
- Never look directly at a lit bulb.
- **Notice: Do not repeatedly turning the light on and off.**

CARE INSTRUCTIONS:

- Unplug lamp before cleaning.
- Wipe clean with a soft, dry cloth or static duster.
- Always avoid the use of harsh chemicals or abrasive cleaners as they may cause damage to the fixture's finish.

*** Do not discard any contents until after assembly is complete to avoid accidentally discarding small parts or hardware.**

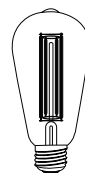

LED
E27 (medium) base
(Not included)

**DO NOT EXCEED THE
SPECIFIED WATTAGE.**

Spécification

Modèle	B31-333
Puissance Max	40W
Entrée Adaptateur	220-240V/50Hz

MISE EN GARDE

- Destinée pour une utilisation a l'intérieur.
- Tenir hors de portée des enfants et des animaux.
- Ne pas utiliser dans la salle de bains ou dans des endroits humides.
- Placez la lampe sur une surface propre et assurez-vous qu'elle soit placée à l'écart de toute matière inflammable.
- Avant de nettoyer la lampe, assurez-vous qu'elle soit éteinte .
- Avant de remplacer l'ampoule, vérifier que le bouchon ait été retiré de la sortie et que la lampe se soit refroidie.
- Ne tirez pas la prise avec les mains mouillées.
- Si le cordon est endommagé, il doit être remplacé par un technicien qualifié.
- Évitez de toucher l'ampoule pendant que le luminaire est sous tension.
- Évitez toujours de regarder directement une ampoule allumée.
- **Remarque : N'allumez pas et n'éteignez pas la lumière à plusieurs reprises.**

INSTRUCTIONS D'ENTRETIEN :

- Déconnectez le luminaire avant de le nettoyer.
- Essuyez-le proprement à l'aide d'un chiffon doux et sec ou d'un essuie-meuble statique.
- Évitez toujours d'utiliser des produits chimiques forts ou agents nettoyants abrasifs, car ils pourront endommager la finition du luminaire.

*** Ne jetez pas le contenu avant d'avoir terminé l'assemblage afin d'éviter de jeter accidentellement de petites pièces ou des accessoires matériels.**

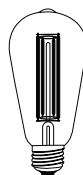

DÉL
Base E27 (moyenne)
(Non inclus)

**NE PAS DÉPASSER LA
PUISSANCE INDIQUÉE.**

Spezifikationen

Modell	B31-333
Max. Leistung	40W
Adaptereingang	220-240V/50Hz

Vorsicht:

- Nur für den Innengebrauch bestimmt.
- Halten Sie die Lampe aus der Reichweite von Kindern und Tieren.
- Stellen Sie die Lampe nicht im Badezimmer oder an feuchten Orten auf.
- Stellen Sie die Lampe auf flachen Oberflächen und nicht in der Nähe von entzündlichen Materialien auf.
- Bevor Sie die Lampe reinigen, stellen Sie sicher, dass diese ausgeschaltet wurde.
- Stellen Sie vor dem Glühbirnenwechsel sicher, dass die Lampe von der Stromversorgung getrennt wurde und die Glühbirne abgekühlt ist.
- Ziehen Sie nicht am Stecker mit nassen Händen.
- Wenn das Stromversorgungskabel beschädigt wurde, darf es nur durch einen qualifizierten Elektriker gewechselt werden.
- Berühren Sie die Glühbirne nicht, wenn die Halterung aktiviert ist.
- Schauen Sie niemals direkt in eine leuchtende Glühbirne.
- **Hinweis: Schalten Sie das Licht nicht wiederholt ein und aus.**

WARTUNGSANWEISUNGEN:

- Trennen Sie vor der Reinigung den Stecker vom Stromnetz..
- Wischen Sie es mit einem weichen, trockenen Tuch oder einem statischen Staubtuch sauber.
- Vermeiden Sie stets die Verwendung von scharfen Chemikalien oder Scheuermitteln, da diese die Oberfläche der Halterung beschädigen können.

*** Entsorgen Sie jeglichen Inhalt erst nach Abschluss der Montage, um ein versehentliches Entsorgen von Kleinteilen oder Hardware zu vermeiden.**

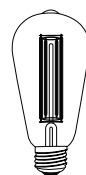

LED
E27 (mittlere) Basis
(Nicht mitgeliefert)

**ÜBERSCHREITEN SIE
DIE
VORGESCHRIEBENE
WATTZAHL NICHT.**

Especificaciones

Modelo	B31-333
Potencia máxima	40W
Adaptador de entrada	220-240V/50Hz

PRECAUCIÓN

- Sólo para uso en interiores.
- Mantener fuera del alcance de los niños y animales.
- No lo use en el baño o en lugares húmedos.
- Coloque la lámpara sobre una superficie limpia y asegúrese de que está colocada lejos de cualquier material inflamable.
- Antes de limpiar la lámpara, asegúrese de que esté apagada.
- Antes de reemplazar la bombilla, asegúrese de que el enchufe ha sido retirado de la toma y la lámpara se ha enfriado.
- No tire del enchufe con las manos mojadas.
- Si el cable de alimentación está dañado, sólo debe ser reemplazado por un ingeniero cualificado.
- No toque las bombillas mientras el aparato esté encendido.
- Nunca mire directamente a una bombilla encendida.
- **Aviso: No encienda y apague la luz repetidamente.**

INSTRUCCIONES DE MANTENIMIENTO:

- Desenchufe la lámpara antes de limpiarla.
- Limpie con un paño suave y seco o un plumero estático.
- Evite siempre el uso de productos químicos agresivos o limpiadores abrasivos, ya que pueden dañar el acabado del aparato.

* **No deseche ningún contenido hasta que se haya completado el montaje para evitar desechar accidentalmente piezas pequeñas o herrajes.**

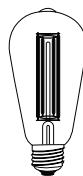

LED
Base de E27 (mediano)
(No incluido)

**NO EXCEDA LA
POTENCIA
ESPECIFICADA**

Especificações

Modelo	B31-333
Potência máxima	40W
Voltagem de entrada	220-240V/50Hz

ATENÇÃO

- Apenas para uso interior.
- Manter fora do alcance das crianças e dos animais. Não utilizar na casa de banho nem em locais húmidos.
- Colocar o candeeiro sobre uma superfície plana e assegurar que é colocado longe de qualquer material inflamável.
- Antes de limpar o candeeiro, certificar-se de que está desligado.
- Antes de substituir a lâmpada, certifique-se de que a ficha foi retirada da tomada e de que a lâmpada arrefeceu.
- Não retire a ficha do soquete com as mãos molhadas.
- Se o cabo de alimentação estiver danificado, só deve ser substituído por um técnico qualificado.
- Não tocar na lâmpada enquanto estiver ligado.
- Nunca olhar diretamente para uma lâmpada acesa.
- **Aviso: Não ligar e desligar a luz repetidamente.**

INSTRUÇÕES DE CUIDADO:

- Desligar a lâmpada antes da limpeza.
- Limpar com um pano macio e seco ou com um espanador de pó.
- Evitar sempre a utilização de produtos químicos agressivos ou de produtos de limpeza abrasivos, pois podem danificar o acabamento do candeeiro.

PT_ Não descartar qualquer conteúdo até que a montagem esteja concluída para evitar descartar acidentalmente pequenas peças ou ferragens.

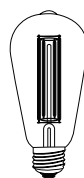

LED
Base E27 (média)
(Não incluída)

**NÃO EXCEDER A
POTÊNCIA
ESPECIFICADA.**

Specifiche

Modello	B31-333
Potenza massima	40W
Ingresso adattatore	220-240V/50Hz

ATTENZIONE

- Solo per uso interno.
- Tenere fuori dalla portata dei bambini e degli animali.
- Non utilizzare in bagno o in luoghi umidi.
- Posizionare la lampada su una superficie piana e accertarsi che sia posizionata lontano da qualsiasi materiale infiammabile.
- Prima di pulire la lampada, assicurarsi che sia spenta.
- Prima di sostituire la lampadina, assicurarsi che la spina sia stata rimossa dalla presa e che la lampada si sia raffreddata.
- Non tirare la spina dalla presa con le mani bagnate.
- Se il cavo di alimentazione è danneggiato, deve essere sostituito da un tecnico qualificato.
- Non toccare la lampadina quando l'apparecchio è acceso.
- Non guardare mai direttamente la lampadina accesa.
- **Attenzione: Non accendere e spegnere ripetutamente la lampadina.**

ISTRUZIONI PER LA CURA:

- Scollegare la lampada prima di pulire.
- Pulire con un panno morbido e asciutto o con uno spolverino statico.
- Evitare sempre di usare prodotti chimici aggressivi o detergenti abrasivi perché potrebbero danneggiare la finitura dell'apparecchio.

*** Non gettare qualsiasi contenuto fino a quando non è completato l'assemblaggio, per evitare di gettare accidentalmente piccole parti o accessori.**

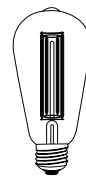

LED
E27 Base(media) (Non
in dotazione)

**NON SUPERARE LA
POTENZA
SPECIFICATA.**

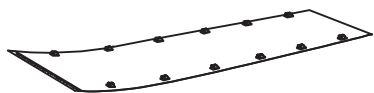
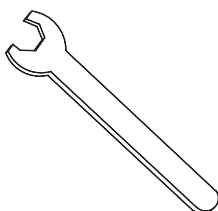
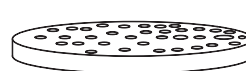
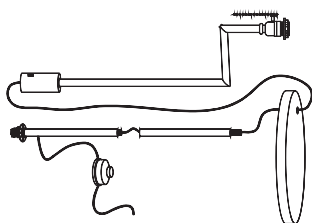
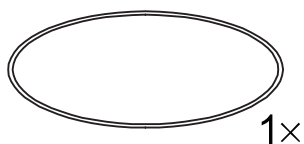
A x 1**B** x 1**C** x 1**D** x 1**E** x 1**F** x 1**G** x 1**C**

1x

B

1x

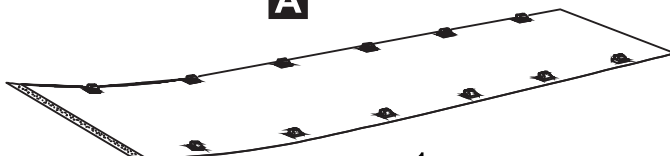
A

1x

1

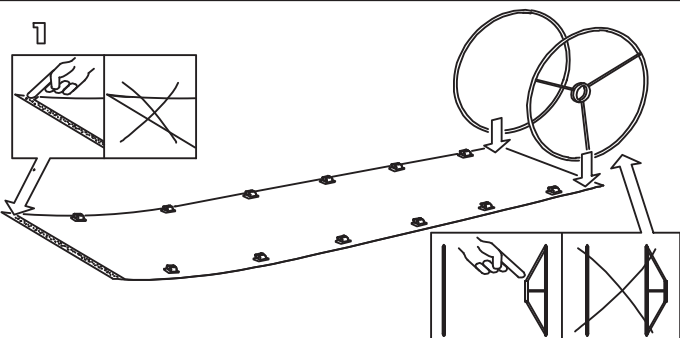

3

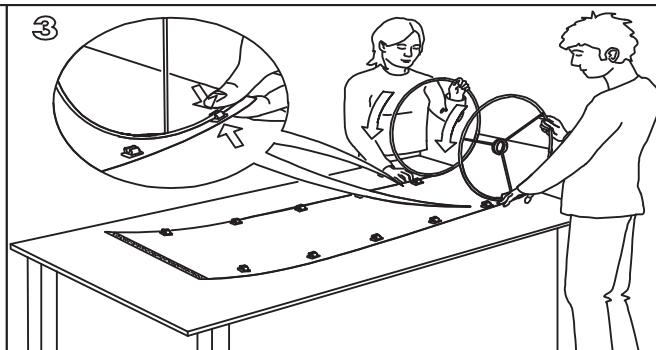

2

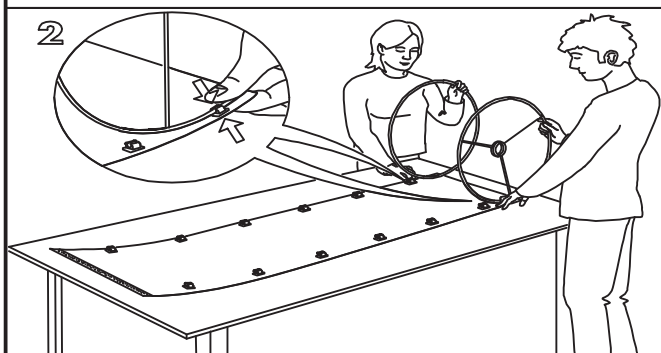

4

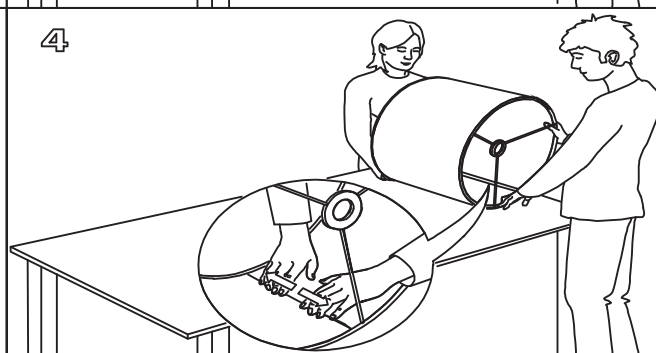

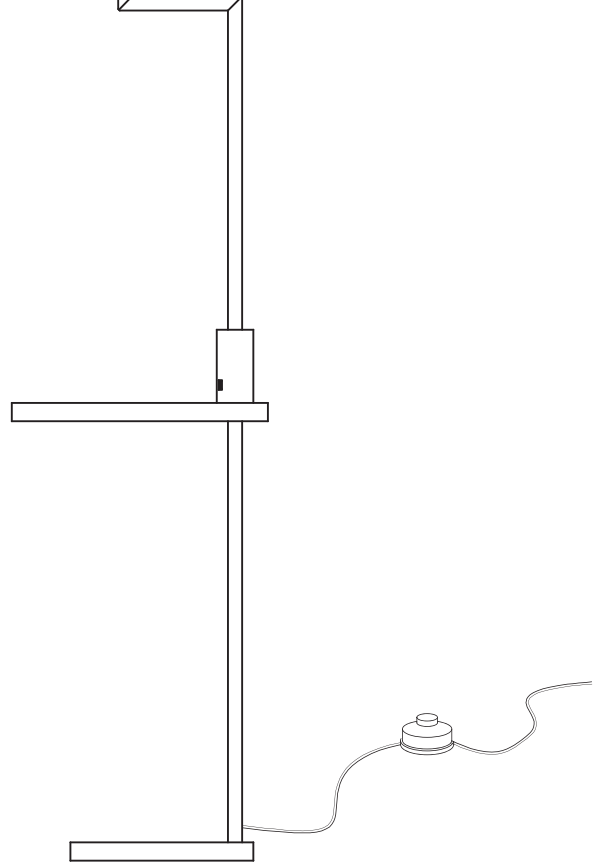
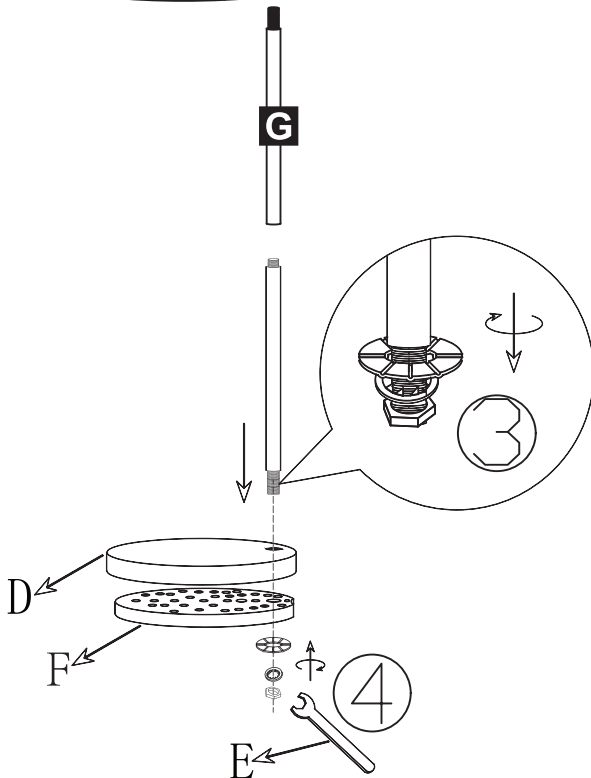
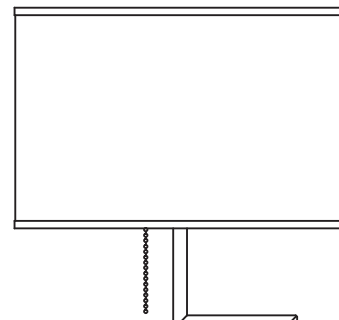
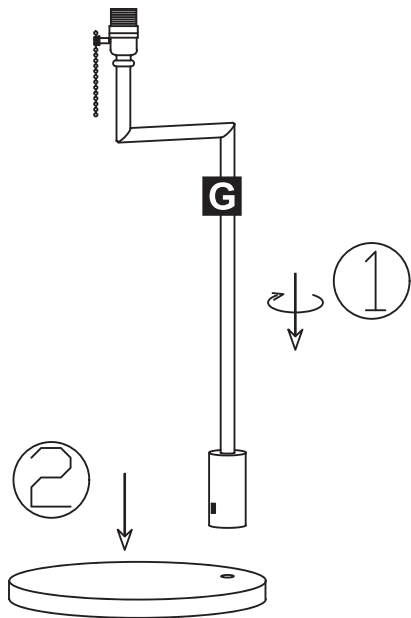
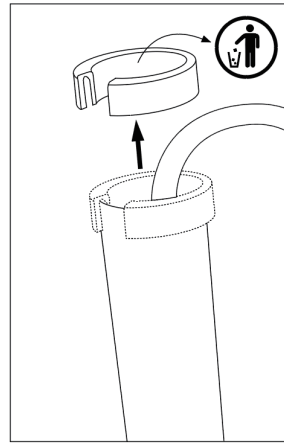
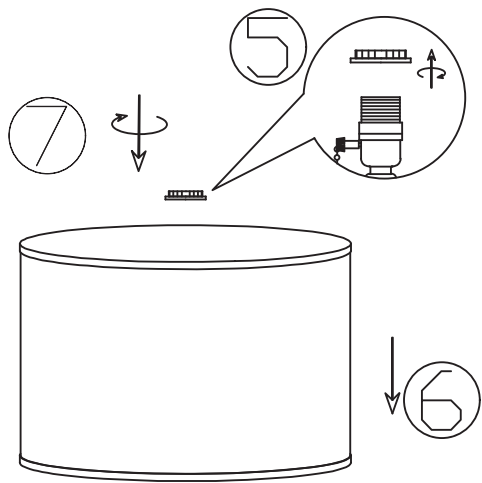

UK

If you have any questions, please contact our customer care center.

Our contact details are below:



0044-800-240-4004



enquiries@mhstar.co.uk

IMPORTER ADDRESS:

MH STAR UK LTD

Unit 27, Perivale Park,

Horsenden lane South

Perivale, UB6 7RH

MADE IN CHINA

ES

Si tiene alguna pregunta, comuníquese con nuestro Centro de Atención al Cliente.

Nuestros datos de contacto son los siguientes:



0034-931294512



atencioncliente@aosom.es

IMPORTADOR:

SPANISH AOSOM, S.L.

C/ ROC GROS, N° 15. 08550, ELS HOSTALETS DE

BALENYÀ, SPAIN.

B66295775

WWW.AOSOM.ES

ATENCIONCLIENTE@AOSOM.ES

TEL: 931294512

HECHO EN CHINA

FR

Si vous avez la moindre question, veuillez contacter notre centre d'assistance à la clientèle.

Nos coordonnées sont les suivantes:



0033-1-84166106



aosom@mhfrance.fr

Importé par:

MH France

2, rue Maurice Hartmann

92130 Issy-les-Moulineaux

France

Fabriqué en Chine

PT

Se tiver alguma dúvida, por favor contacte o nosso Centro de Atendimento ao Cliente.

Os nossos dados de contacto são os seguintes:



0034-931294512



info@aosom.pt.

IMPORTADOR:

SPANISH AOSOM, S.L

C.ROC GROS N.15, 08550. ELS HOSTALETS DE BALENYÀ

TEL: 931294512 (SEG-SEX DAS 7:30H ÀS 16:30H)

INFO@AOSOM.PT

WWW.AOSOM.PT

DE

Wenn Sie Fragen haben, wenden Sie sich bitte an unser Kundendienstzentrum.

Unsere Kontaktdaten stehen unten:



0049-0(40)-88307530



service@aosom.de

ADRESSE DES IMPORTEURE:

MH Handel GmbH

Wendenstraße 309

D-20537 Hamburg

Germany

IN CHINA HERGESTELLT

IT

In caso di dubbio, si prega di contattare il nostro centro assistenza clienti.

I nostri dettagli di contatto sono di seguito:



0039-0249471447



clienti@aosom.it

IMPORTATO DA:

AOSOM Italy srl

Centro Direzionale Milanofiori

Strada 1 Palazzo F1

20057 Assago (MI)

P.I.: 08567220960

FATTO IN CINA