

**EN\_ IMPORTANT, RETAIN FOR FUTURE REFERENCE: READ CAREFULLY.**

**FR\_ IMPORTANT: A LIRE ATTENTIVEMENT ET A CONSERVER POUR VOUS Y REFRERER ULTERIEUREMENT.**

**ES\_ IMPORTANTE, LEA DETENIDAMENTE Y GUARDE PARA FUTURAS REFERENCIAS.**

**PT\_ IMPORTANTE, GUARDE PARA FUTURA REFERÊNCIA, LEIA ATENTAMENTE.**

**DE\_ WICHTIG! SORGFÄLTIG LESEN UND FÜR SPÄTER NACHSCHLAGEN AUFBEWAHREN.**

**IT\_ IMPORTANTE, LEGGERE E CONSERVARE QUESTO MANUALE D'ISTRUZIONE PER UN USO FUTURO.**

## Specification

Model	B31-328
Max power	40W
Adapter input	220-240V/50Hz

### CAUTION

- For indoor use only.
- Keep out of reach of children and animals.
- Do not use in the bathroom or damp places.
- Place the lamp on a flat surface and ensure it is placed away from any flammable materials.
- Before cleaning the lamp, ensure it is switched off.
- Before replacing the bulb, ensure the plug has been removed from the socket and the lamp has cooled down.
- Do not pull the plug out of the socket with wet hands.
- If the supply cord is damaged it must only be replaced by a qualified engineer.
- Do not touch light bulb while fixture is turned on.
- Never look directly at a lit bulb.
- **Notice: Do not repeatedly turning the light on and off.**

### CARE INSTRUCTIONS:

- Unplug lamp before cleaning.
- Wipe clean with a soft, dry cloth or static duster.
- Always avoid the use of harsh chemicals or abrasive cleaners as they may cause damage to the fixture's finish.

**\* Do not discard any contents until after assembly is complete to avoid accidentally discarding small parts or hardware.**

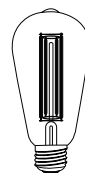

LED  
E27 (medium) base  
(Not included)

**DO NOT EXCEED THE  
SPECIFIED WATTAGE.**

## Spécification

Modèle	B31-328
Puissance Max	40W
Entrée Adaptateur	220-240V/50Hz

### MISE EN GARDE

- Destinée pour une utilisation a l'intérieur.
- Tenir hors de portée des enfants et des animaux.
- Ne pas utiliser dans la salle de bains ou dans des endroits humides.
- Placez la lampe sur une surface propre et assurez-vous qu'elle soit placée à l'écart de toute matière inflammable.
- Avant de nettoyer la lampe, assurez-vous qu'elle soit éteinte .
- Avant de remplacer l'ampoule, vérifier que le bouchon ait été retiré de la sortie et que la lampe se soit refroidie.
- Ne tirez pas la prise avec les mains mouillées.
- Si le cordon est endommagé, il doit être remplacé par un technicien qualifié.
- Évitez de toucher l'ampoule pendant que le luminaire est sous tension.
- Évitez toujours de regarder directement une ampoule allumée.
- **Remarque : N'allumez pas et n'éteignez pas la lumière à plusieurs reprises.**

### INSTRUCTIONS D'ENTRETIEN :

- Déconnectez le luminaire avant de le nettoyer.
- Essuyez-le proprement à l'aide d'un chiffon doux et sec ou d'un essuie-meuble statique.
- Évitez toujours d'utiliser des produits chimiques forts ou agents nettoyants abrasifs, car ils pourront endommager la finition du luminaire.

**\* Ne jetez pas le contenu avant d'avoir terminé l'assemblage afin d'éviter de jeter accidentellement de petites pièces ou des accessoires matériels.**

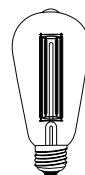

DÉL  
Base E27 (moyenne)  
(Non inclus)

**NE PAS DÉPASSER LA  
PUISSANCE INDIQUÉE.**

## Spezifikationen

Modell	B31-328
Max. Leistung	40W
Adaptereingang	220-240V/50Hz

### Vorsicht:

- Nur für den Innengebrauch bestimmt.
- Halten Sie die Lampe aus der Reichweite von Kindern und Tieren.
- Stellen Sie die Lampe nicht im Badezimmer oder an feuchten Orten auf.
- Stellen Sie die Lampe auf flachen Oberflächen und nicht in der Nähe von entzündlichen Materialien auf.
- Bevor Sie die Lampe reinigen, stellen Sie sicher, dass diese ausgeschaltet wurde.
- Stellen Sie vor dem Glühbirnenwechsel sicher, dass die Lampe von der Stromversorgung getrennt wurde und die Glühbirne abgekühlt ist.
- Ziehen Sie nicht am Stecker mit nassen Händen.
- Wenn das Stromversorgungskabel beschädigt wurde, darf es nur durch einen qualifizierten Elektriker gewechselt werden.
- Berühren Sie die Glühbirne nicht, wenn die Halterung aktiviert ist.
- Schauen Sie niemals direkt in eine leuchtende Glühbirne.
- **Hinweis: Schalten Sie das Licht nicht wiederholt ein und aus.**

### WARTUNGSANWEISUNGEN:

- Trennen Sie vor der Reinigung den Stecker vom Stromnetz..
- Wischen Sie es mit einem weichen, trockenen Tuch oder einem statischen Staubtuch sauber.
- Vermeiden Sie stets die Verwendung von scharfen Chemikalien oder Scheuermitteln, da diese die Oberfläche der Halterung beschädigen können.

**\* Entsorgen Sie jeglichen Inhalt erst nach Abschluss der Montage, um ein versehentliches Entsorgen von Kleinteilen oder Hardware zu vermeiden.**

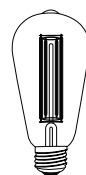

LED  
E27 (mittlere) Basis  
(Nicht mitgeliefert)

**ÜBERSCHREITEN SIE  
DIE  
VORGESCHRIEBENE  
WATTZAHL NICHT.**

## Especificaciones

Modelo	B31-328
Potencia máxima	40W
Adaptador de entrada	220-240V/50Hz

### PRECAUCIÓN

- Sólo para uso en interiores.
- Mantener fuera del alcance de los niños y animales.
- No lo use en el baño o en lugares húmedos.
- Coloque la lámpara sobre una superficie limpia y asegúrese de que está colocada lejos de cualquier material inflamable.
- Antes de limpiar la lámpara, asegúrese de que esté apagada.
- Antes de reemplazar la bombilla, asegúrese de que el enchufe ha sido retirado de la toma y la lámpara se ha enfriado.
- No tire del enchufe con las manos mojadas.
- Si el cable de alimentación está dañado, sólo debe ser reemplazado por un ingeniero cualificado.
- No toque las bombillas mientras el aparato esté encendido.
- Nunca mire directamente a una bombilla encendida.
- **Aviso: No encienda y apague la luz repetidamente.**

### INSTRUCCIONES DE MANTENIMIENTO:

- Desenchufe la lámpara antes de limpiarla.
- Limpie con un paño suave y seco o un plumero estático.
- Evite siempre el uso de productos químicos agresivos o limpiadores abrasivos, ya que pueden dañar el acabado del aparato.

\* **No deseche ningún contenido hasta que se haya completado el montaje para evitar desechar accidentalmente piezas pequeñas o herrajes.**

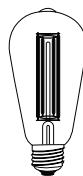

LED  
Base de E27 (mediano)  
(No incluido)

**NO EXCEDA LA  
POTENCIA  
ESPECIFICADA**

## Especificações

Modelo	B31-328
Potência máxima	40W
Voltagem de entrada	220-240V/50Hz

### ATENÇÃO

- Apenas para uso interior.
- Manter fora do alcance das crianças e dos animais. Não utilizar na casa de banho nem em locais húmidos.
- Colocar o candeeiro sobre uma superfície plana e assegurar que é colocado longe de qualquer material inflamável.
- Antes de limpar o candeeiro, certificar-se de que está desligado.
- Antes de substituir a lâmpada, certifique-se de que a ficha foi retirada da tomada e de que a lâmpada arrefeceu.
- Não retire a ficha do soquete com as mãos molhadas.
- Se o cabo de alimentação estiver danificado, só deve ser substituído por um técnico qualificado.
- Não tocar na lâmpada enquanto estiver ligado.
- Nunca olhar diretamente para uma lâmpada acesa.
- **Aviso: Não ligar e desligar a luz repetidamente.**

### INSTRUÇÕES DE CUIDADO:

- Desligar a lâmpada antes da limpeza.
- Limpar com um pano macio e seco ou com um espanador de pó.
- Evitar sempre a utilização de produtos químicos agressivos ou de produtos de limpeza abrasivos, pois podem danificar o acabamento do candeeiro.

**PT\_Não descartar qualquer conteúdo até que a montagem esteja concluída para evitar descartar acidentalmente pequenas peças ou ferragens.**

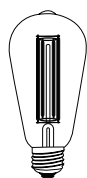

LED  
Base E27 (média)  
(Não incluída)

**NÃO EXCEDER A  
POTÊNCIA  
ESPECIFICADA.**

## Specifiche

Modello	B31-328
Potenza massima	40W
Ingresso adattatore	220-240V/50Hz

### ATTENZIONE

- Solo per uso interno.
- Tenere fuori dalla portata dei bambini e degli animali.
- Non utilizzare in bagno o in luoghi umidi.
- Posizionare la lampada su una superficie piana e accertarsi che sia posizionata lontano da qualsiasi materiale infiammabile.
- Prima di pulire la lampada, assicurarsi che sia spenta.
- Prima di sostituire la lampadina, assicurarsi che la spina sia stata rimossa dalla presa e che la lampada si sia raffreddata.
- Non tirare la spina dalla presa con le mani bagnate.
- Se il cavo di alimentazione è danneggiato, deve essere sostituito da un tecnico qualificato.
- Non toccare la lampadina quando l'apparecchio è acceso.
- Non guardare mai direttamente la lampadina accesa.
- **Attenzione: Non accendere e spegnere ripetutamente la lampadina.**

### ISTRUZIONI PER LA CURA:

- Scollegare la lampada prima di pulire.
- Pulire con un panno morbido e asciutto o con uno spolverino statico.
- Evitare sempre di usare prodotti chimici aggressivi o detersivi abrasivi perché potrebbero danneggiare la finitura dell'apparecchio.

**\* Non gettare qualsiasi contenuto fino a quando non è completato l'assemblaggio, per evitare di gettare accidentalmente piccole parti o accessori.**

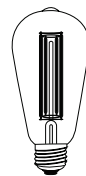

LED  
E27 Base(media) (Non  
in dotazione)

**NON SUPERARE LA  
POTENZA  
SPECIFICATA.**

**A** x 1

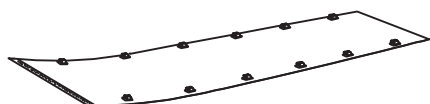

**B** x 1

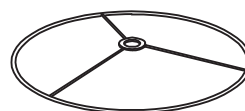

**C** x 1



**D** x 1



**E** x 1

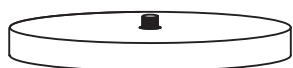

**F** x 1

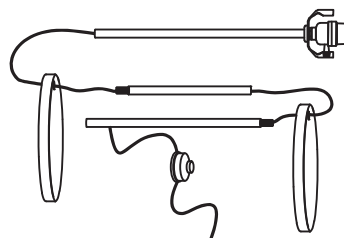

**C**

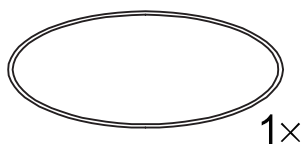

**B**

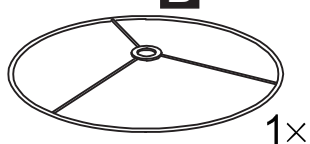

**A**

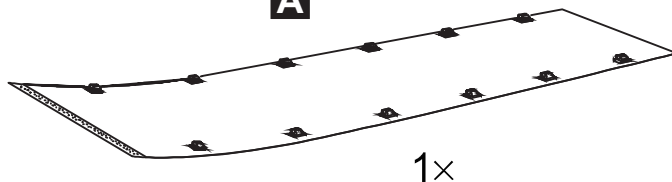

1

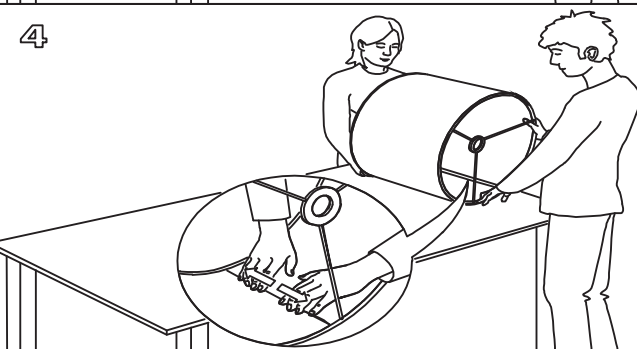
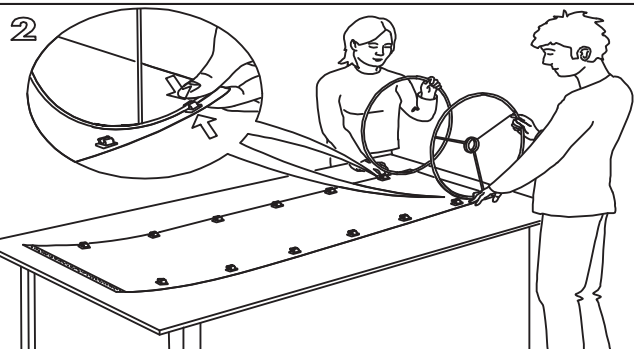
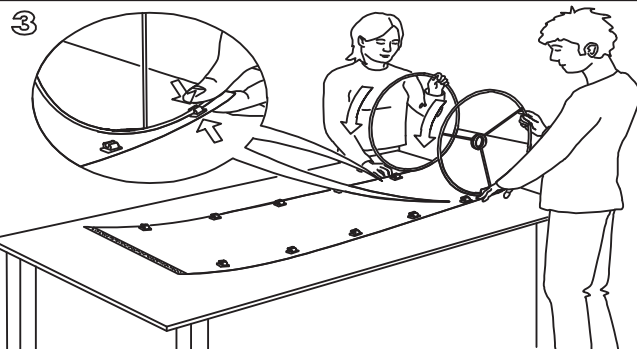
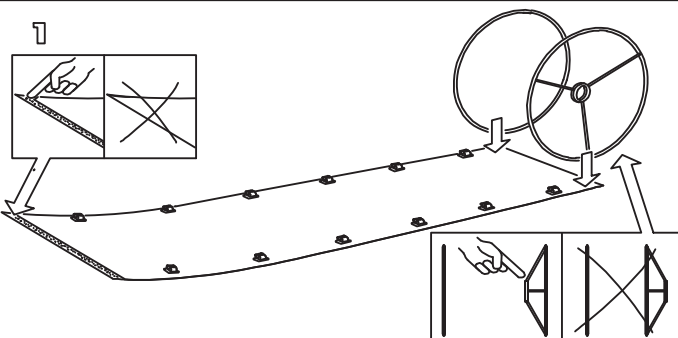



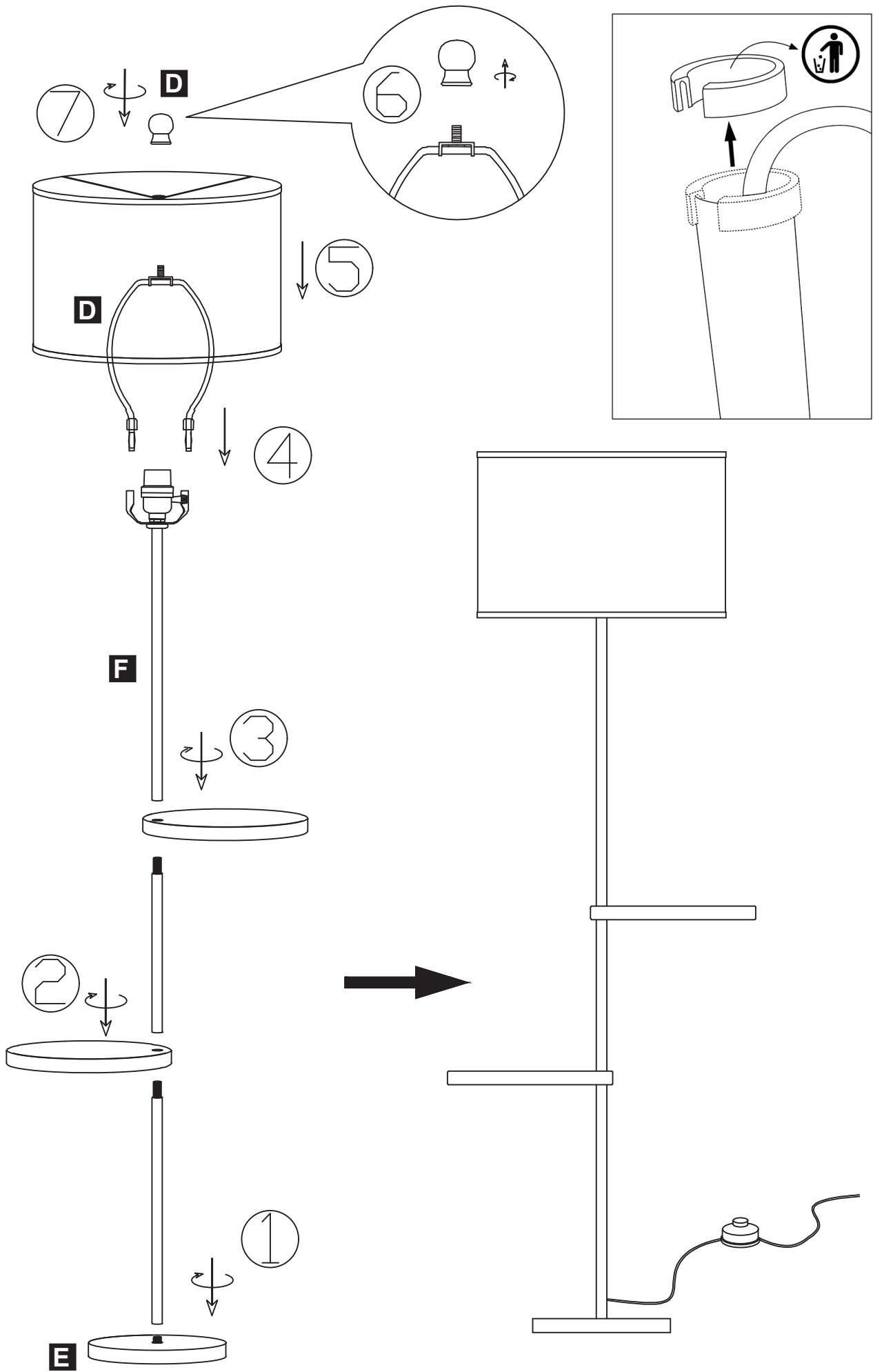

**D**

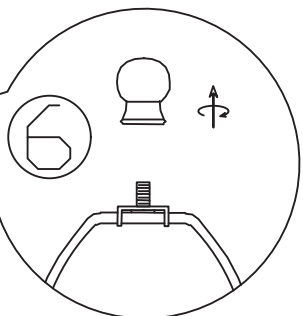

6

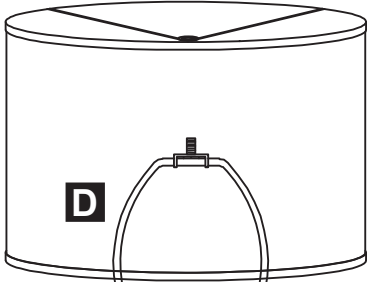
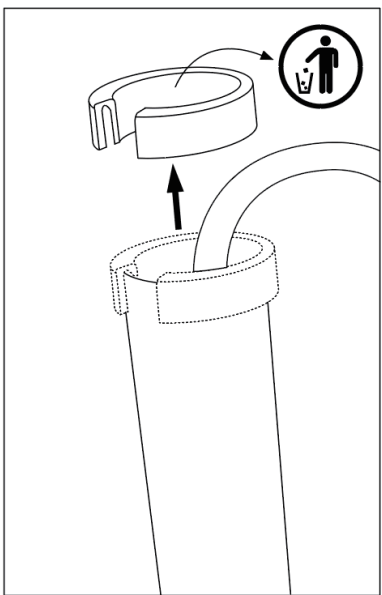

**D**

5

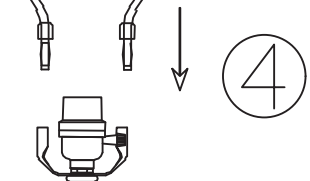

4



**F**

3

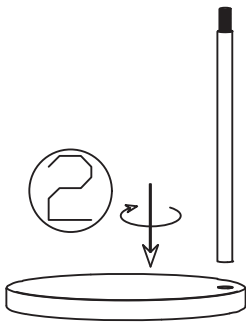

2

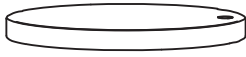

**E**

1

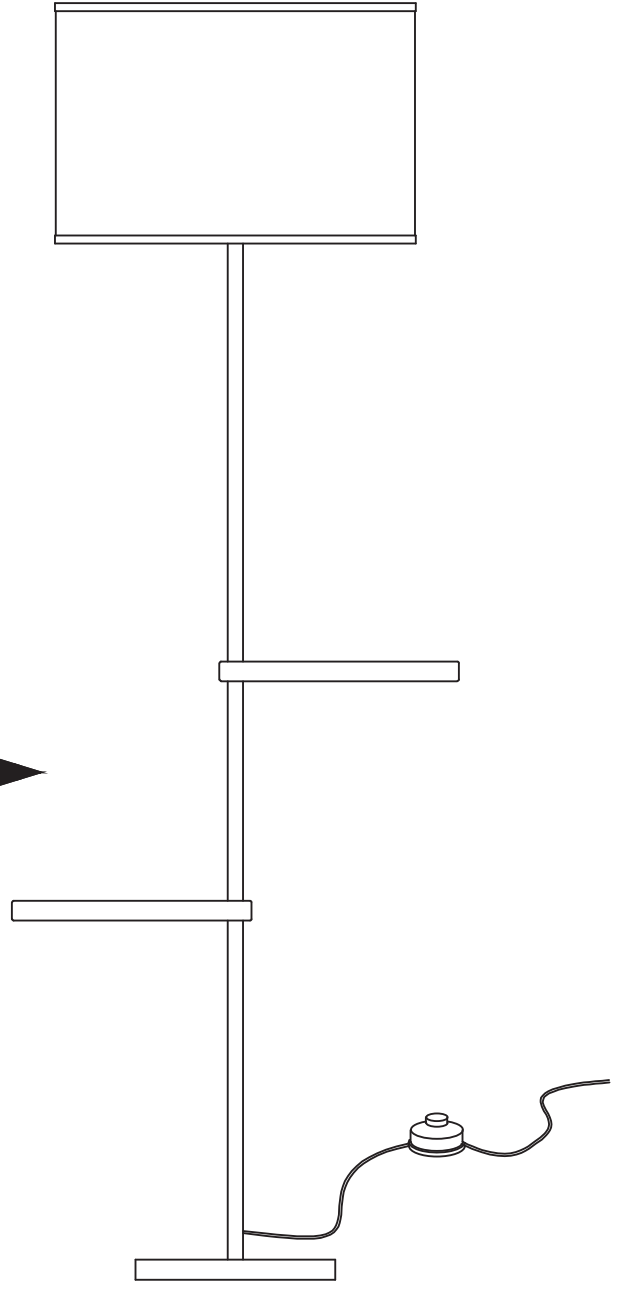
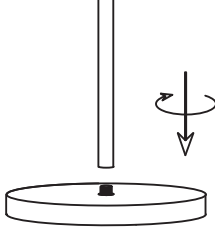

**UK**

If you have any questions, please contact our customer care center.

Our contact details are below:



0044-800-240-4004



enquiries@mhstar.co.uk

IMPORTER ADDRESS:

MH STAR UK LTD

Unit 27, Perivale Park,  
Horsenden lane South

Perivale, UB6 7RH

MADE IN CHINA

**ES**

Si tiene alguna pregunta, comuníquese con nuestro Centro de Atención al Cliente. Nuestros datos de contacto son los siguientes:



0034-931294512



atencioncliente@aosom.es

IMPORTADOR:

SPANISH AOSOM, S.L.

C/ ROC GROS, N° 15. 08550, ELS HOSTALETS DE  
BALENYÀ, SPAIN.

B66295775

WWW.AOSOM.ES

ATENCIONCLIENTE@AOSOM.ES

TEL: 931294512

HECHO EN CHINA

**FR**

Si vous avez la moindre question, veuillez contacter notre centre d'assistance à la clientèle.

Nos coordonnées sont les suivantes:



0033-1-84166106



aosom@mhfrance.fr

Importé par:

MH France

2, rue Maurice Hartmann

92130 Issy-les-Moulineaux

France

Fabriqué en Chine

**PT**

Se tiver alguma dúvida, por favor contacte o nosso Centro de Atendimento ao Cliente. Os nossos dados de contacto são os seguintes:



0034-931294512



info@aosom.pt.

IMPORTADOR:

SPANISH AOSOM, S.L

C.ROC GROS N.15, 08550. ELS HOSTALETS DE BALENYÀ

TEL: 931294512 (SEG-SEX DAS 7:30H ÀS 16:30H)

INFO@AOSOM.PT

WWW.AOSOM.PT

**DE**

Wenn Sie Fragen haben, wenden Sie sich bitte an unser Kundendienstzentrum.

Unsere Kontaktdaten stehen unten:



0049-0(40)-88307530



service@aosom.de

ADRESSE DES IMPORTEURE:

MH Handel GmbH

Wendenstraße 309

D-20537 Hamburg

Germany

IN CHINA HERGESTELLT

**IT**

In caso di dubbio, si prega di contattare il nostro centro assistenza clienti. I nostri dettagli di contatto sono di seguito:



0039-0249471447



clienti@aosom.it

IMPORTATO DA:

AOSOM Italy srl

Centro Direzionale Milanofiori

Strada 1 Palazzo F1

20057 Assago (MI)

P.I.: 08567220960

FATTO IN CINA