

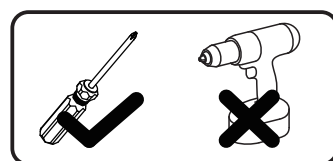

IN220901602V01_US_CA

838-129_838-129V80

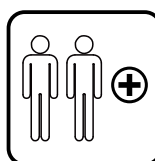
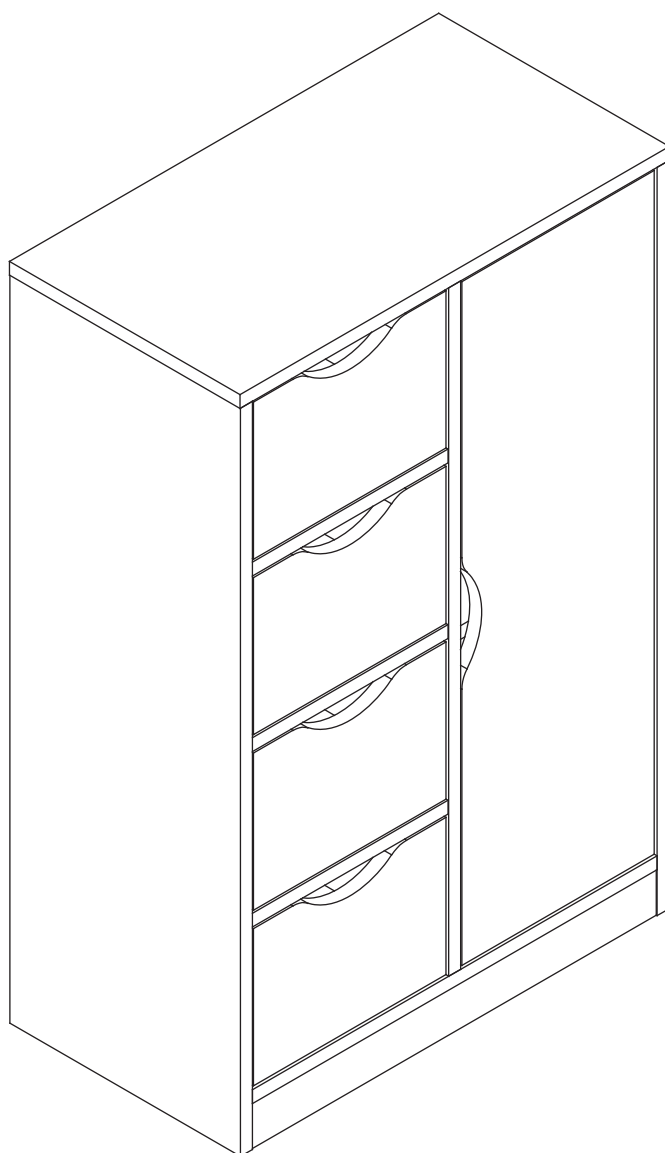

EN_IMPORTANT, RETAIN FOR FUTURE REFERENCE: READ CAREFULLY.

FR_IMPORTANT: A LIRE ATTENTIVEMENT ET À CONSERVER POUR CONSULTATION ULTÉRIEURE.

ES_IMPORTANTE, LEA Y GUARDE PARA FUTURAS REFERENCIAS.

DE_, WICHTIG! SORGFÄLTIG LESEN UND FÜR SPÄTER NACHSCHLAGEN AUFBEWAHREN."

IT_IMPORTANTE! CONSERVARE IL PRESENTE MANUALE PER FUTURO RIFERIMENTO E LEGGERLO ATTENTAMENTE.

EN

Dear customer,

Thank you for purchasing this product. So that your appliance serves you well, please read all the instructions in this user's manual. If you have any questions, please contact our customer care center.

FR

Cher client,

Nous vous remercions d'avoir acheté ce produit. Afin que vous puissiez profiter pleinement de votre appareil, veuillez lire toutes les instructions de ce manuel d'utilisation. Si vous avez la moindre question, veuillez contacter notre centre d'assistance à la clientèle.

DE

Sehr geehrter Kunde,

Vielen Dank, dass Sie dieses Produkt erworben haben. Damit Ihr Gerät Ihnen gute Dienste leistet, lesen Sie bitte alle Hinweise in diesem Benutzerhandbuch. Wenn Sie Fragen haben, wenden Sie sich bitte an unser Kundendienstzentrum.

ES

Queridos clientes,

Gracias por comprar este producto. Para que su electrodoméstico le sirva mejor, lea todas las instrucciones de este manual del usuario. Si tiene alguna pregunta, comuníquese con nuestro Centro de Atención al Cliente.

IT

Caro Cliente,

Grazie per aver acquistato questo prodotto. Per servirti meglio con questo apparecchio ti prego di leggere tutte le istruzioni in presente manuale utente. In caso di dubbio, si prega di contattare il nostro centro assistenza clienti.



EN_Our contact details are below:

FR_Nos coordonnées sont les suivantes:

DE_Unsere Kontaktdaten stehen unten:

ES_Nuestros datos de contacto son los siguientes:

IT_I nostri dettagli di contatto sono di seguito:

Country	 Phone	 Email
US	001-877-644-9366	customerservice@aosom.com
CA	416-792-6088	customerservice@aosom.ca

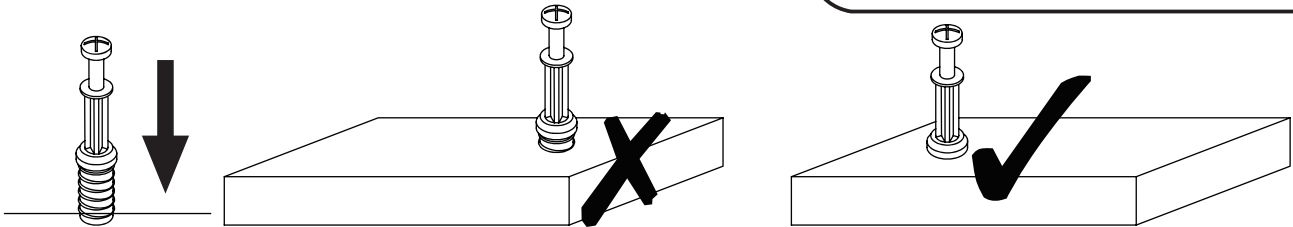

EN_QUICKFIT: Tighten quickfit until shoulder is flush with panel. Do not overtighten or undertighten.

FR_RACCORD RAPIDE: Faites serrer le raccord rapide jusqu'à ce que l'épaulement soit parfaitement encastré dans le panneau. Il ne faut ni trop serrer ni insuffisamment serrer.

ES_QUICKFIT: Apriete quickfit hasta que el hombro se descargue con el panel. NO lo sobreapriete ni lo apriete poco.

DE_QUICKFIT: Ziehen Sie den Quickfit fest, bis die Schulter mit der Platte bündig ist. Bitte nicht zu fest oder zu schwach anziehen.

IT_MONTAGGIO RAPIDO: Stringere il montaggio rapido fino a quando la spalla è a filo con il pannello, non stringere troppo o troppo poco.

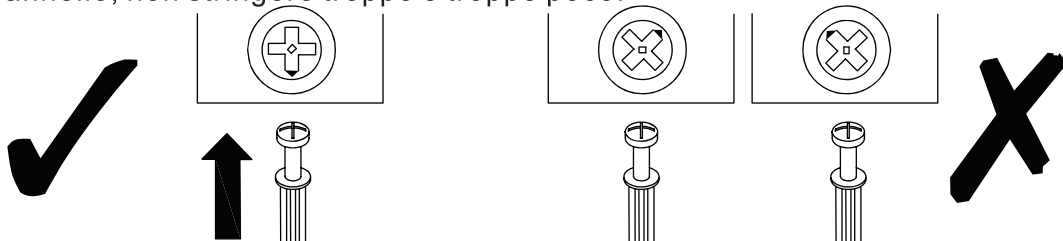

EN_CAM LOCK: When fitting cam lock, ensure starting position is correct before you insert connecting quickfit.

FR_SERRURE BATTEUSE: Avant d'insérer la serrure batteuse, veillez à la bonne orientation avant d'insérer le raccord rapide.

ES_CIERRE DE LA CÁMARA: Cuando instale el cierre de la cámara, asegúrese de que la posición de inicio es correcta antes de que inserte el quickfit conector.

DE_CAM-LOCK: Achten Sie bei der Montage des Cam-Locks auf die richtige Ausgangsposition, bevor Sie den Quickfit einsetzen.

IT_BLOCCAGGIO A CAMMA: Quando si monta il bloccaggio a camma, assicurarsi che la posizione iniziale sia corretta prima di inserire il montaggio rapido di collegamento.

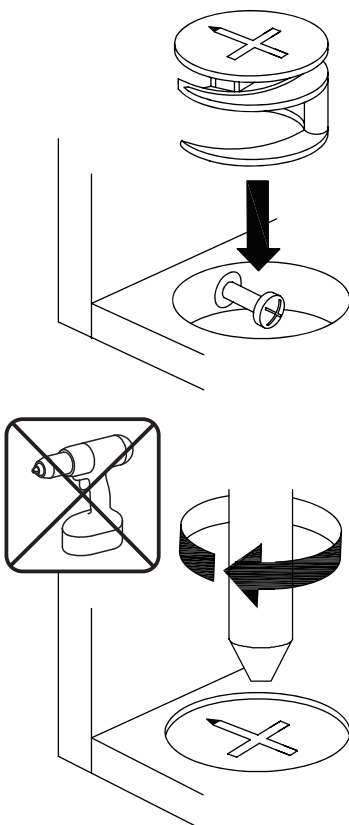

EN_Quickfit head should be in the centre of the cam lock when the two panels are joined.

Cam lock should be inserted before quickfit.

FR_Lorsque les deux panneaux sont assemblés, la tête du raccord rapide doit reposer au centre de la serrure batteuse.

Il faut insérer la serrure batteuse avant le raccord rapide.

ES_El cabezal del quickfit debe estar en el centro del cierre de la cámara cuando se unan los dos paneles.

Se debe insertar el cierre de la cámara antes que el quickfit.

DE_Der Quickfit-Kopf sollte sich in der Mitte des Cam-Locks befinden, wenn die beiden Platten zusammengefügt sind.

Der Cam-Lock sollte vor dem Quickfit eingesetzt werden.

IT_La testa del montaggio rapido deve trovarsi al centro del bloccaggio a camma quando i due pannelli sono uniti.

Il Bloccaggio a Camma deve essere inserito prima del montaggio rapido.

EN_Turn cam lock clockwise to tighten.

FR_Faites tourner la serrure batteuse dans le sens des aiguilles d'une montre pour la resserrer.

ES_Gire el cierre de la cámara en sentido horario para apretarlo.

DE_Drehen Sie den Cam-Lock im Uhrzeigersinn, um ihn festzuziehen.

IT_Ruotare il bloccaggio a camma in senso orario per stringere.

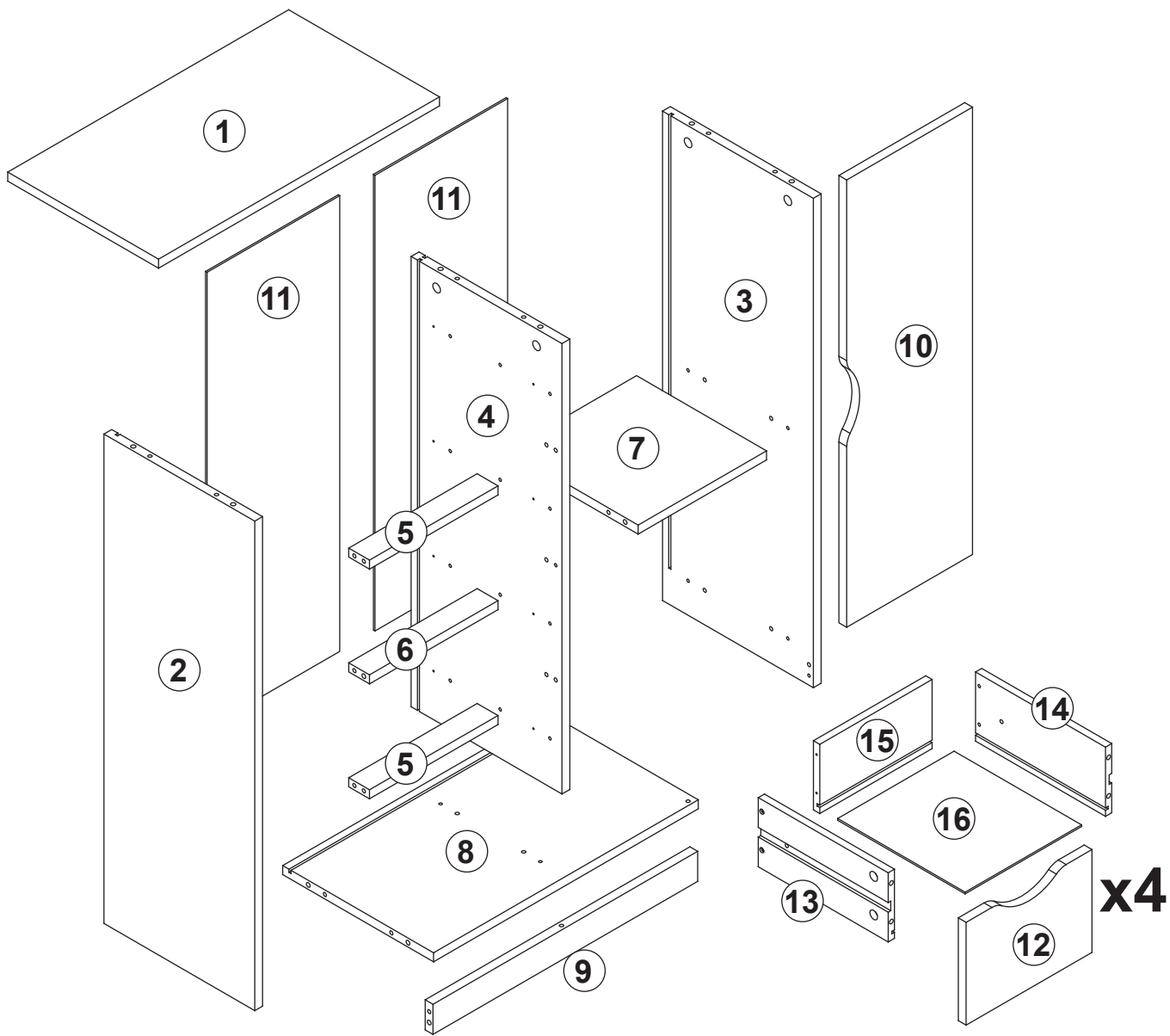

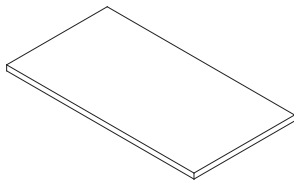

① x 1

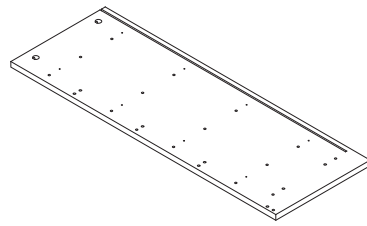

② x 1

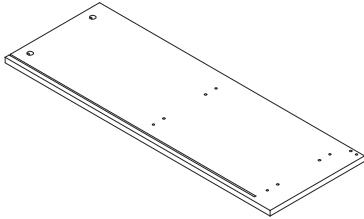

③ x 1

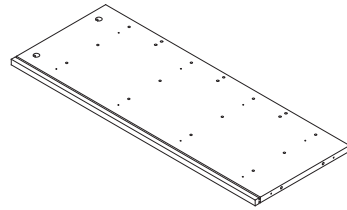

④ x 1

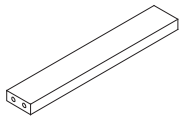

⑤ x 2

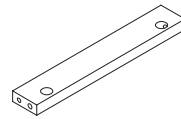

⑥ x 1

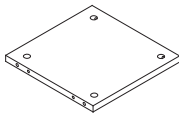

⑦ x 1

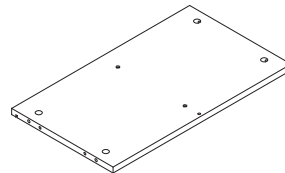

⑧ x 1

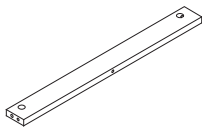

⑨ x 1

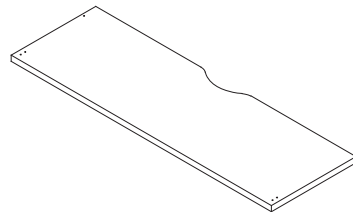

⑩ x 1

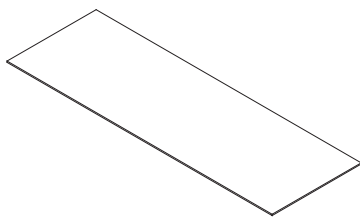

⑪ x 2

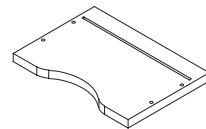

⑫ x 4

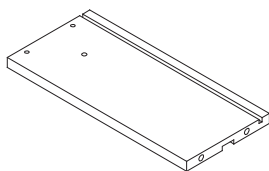

⑬ x 4

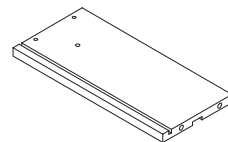

⑭ x 4

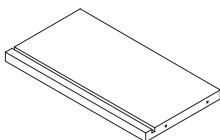

⑮ x 4

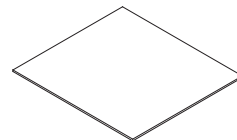

⑯ x 4

A x 34
+1 (spare)

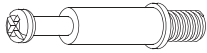

B x 34
+1 (spare)

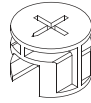

C x 29
+1 (spare)

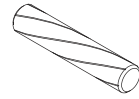

D x 18
+1 (spare)

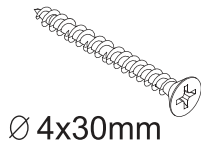

E x 21
+1 (spare)



F x 10
+1 (spare)



G x 8

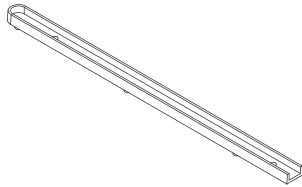

H x 1

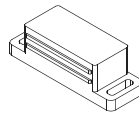

I x 1

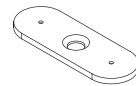

J x 8

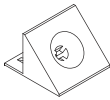

K x 1

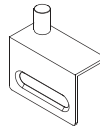

L x 1

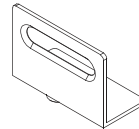

M x 8

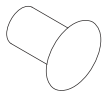

N x 1

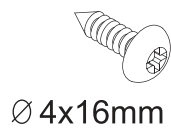

O x 1

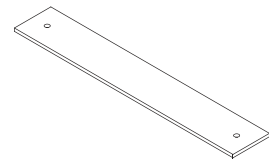

P x 1

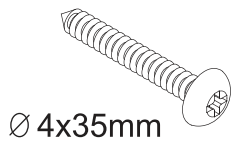

Q x 1

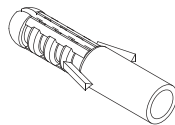

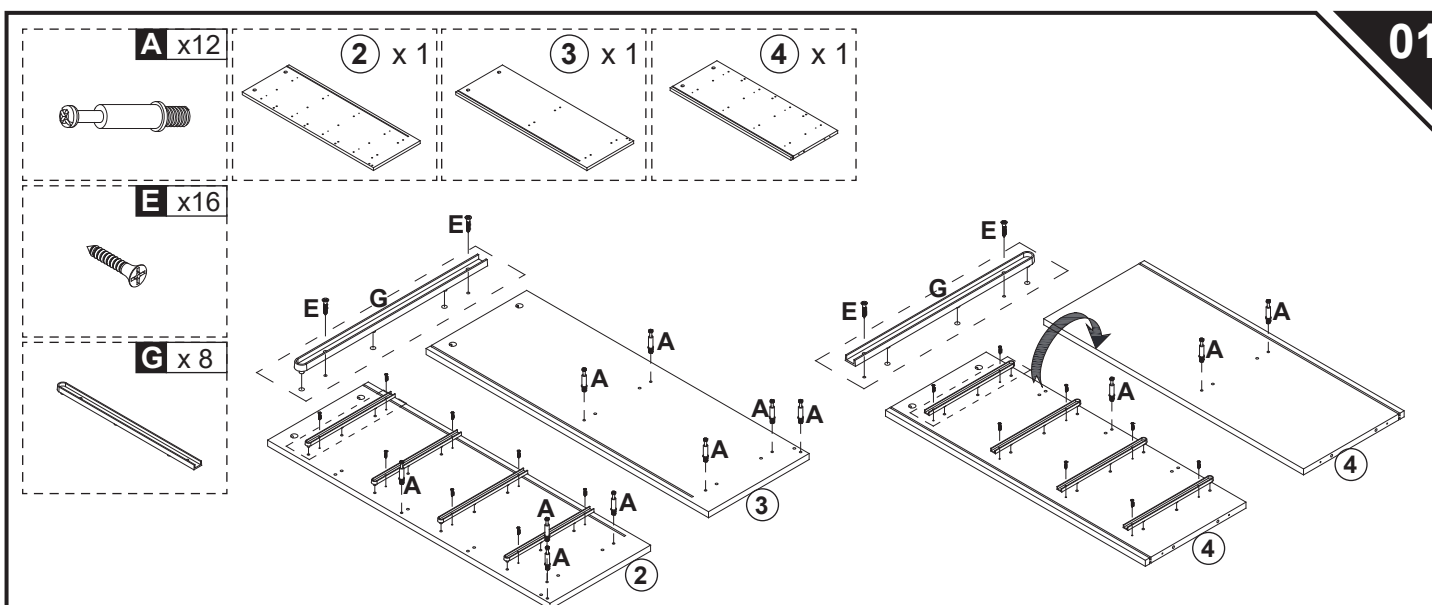

EN Please find the exact hole for installation, otherwise it will be misaligned. The screws on the drawer slide must be leveled, otherwise it will affect the smoothness of the drawer.

FR Identifiez le trou exact pour l'installation, sinon il sera mal aligné. Les vis de la glissière du tiroir doivent être nivelées, sinon cela affectera le fonctionnement du tiroir.

ES Al instalar, encuentre el orificio exacto; de lo contrario, estará desalineado. Los tornillos en las correderas del cajón deben estar nivelados, de lo contrario, afectará la suavidad al deslizar el cajón.

DE Bitte finden Sie das genaue Loch für die Installation, sonst wird es falsch ausgerichtet werden. Die Schrauben an der Schubladenführung müssen nivelliert werden, da sonst die Leichtgängigkeit der Schublade beeinträchtigt wird.

IT individuare il foro esatto per l'installazione, altrimenti ci sarà un disallineamento. Le viti sulla guida del cassetto devono essere allineate, altrimenti influirà sulla scorrevolezza del cassetto.

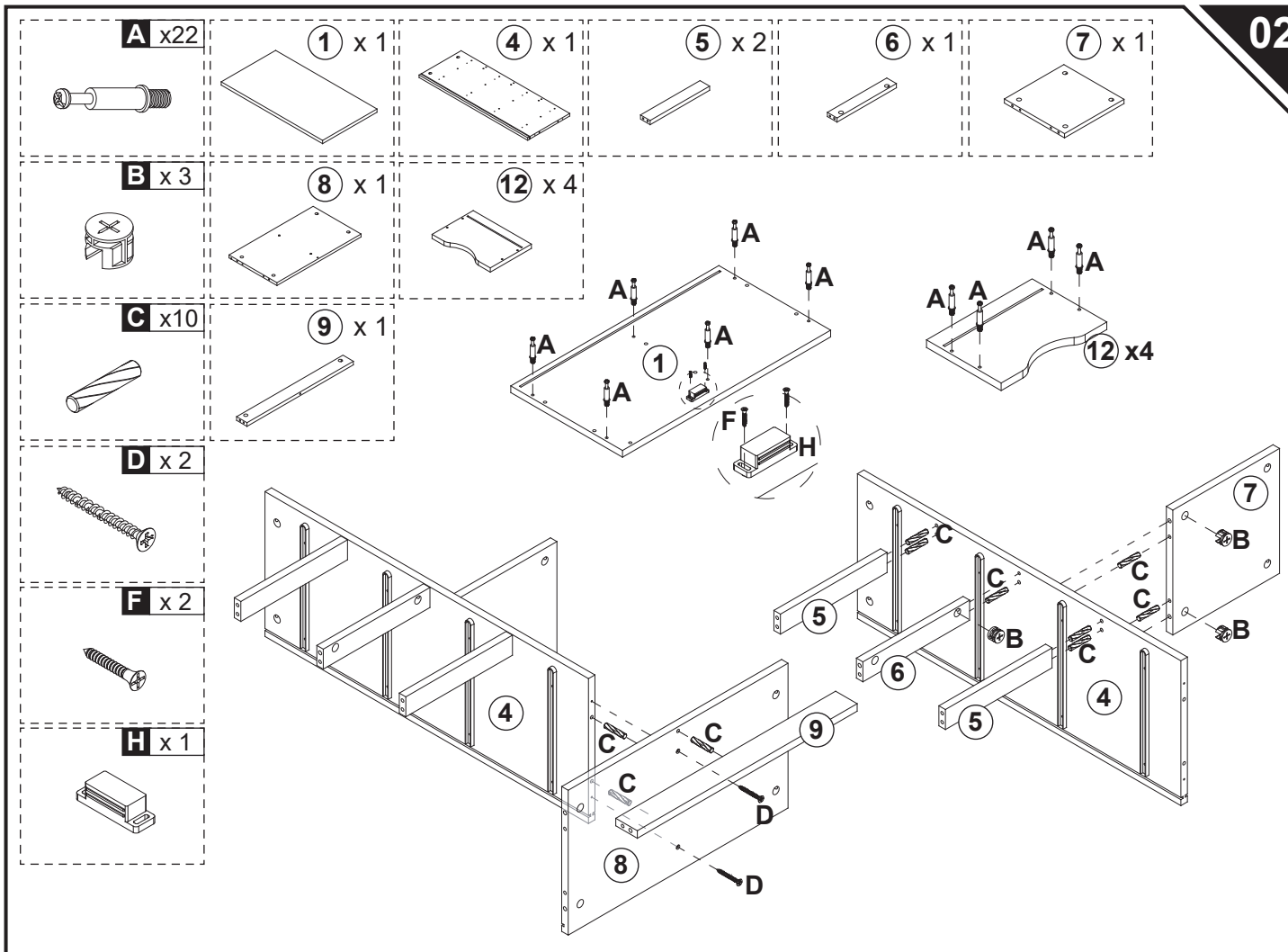

B x 9



C x 13



2 x 1

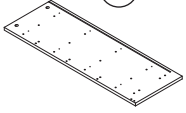

3 x 1

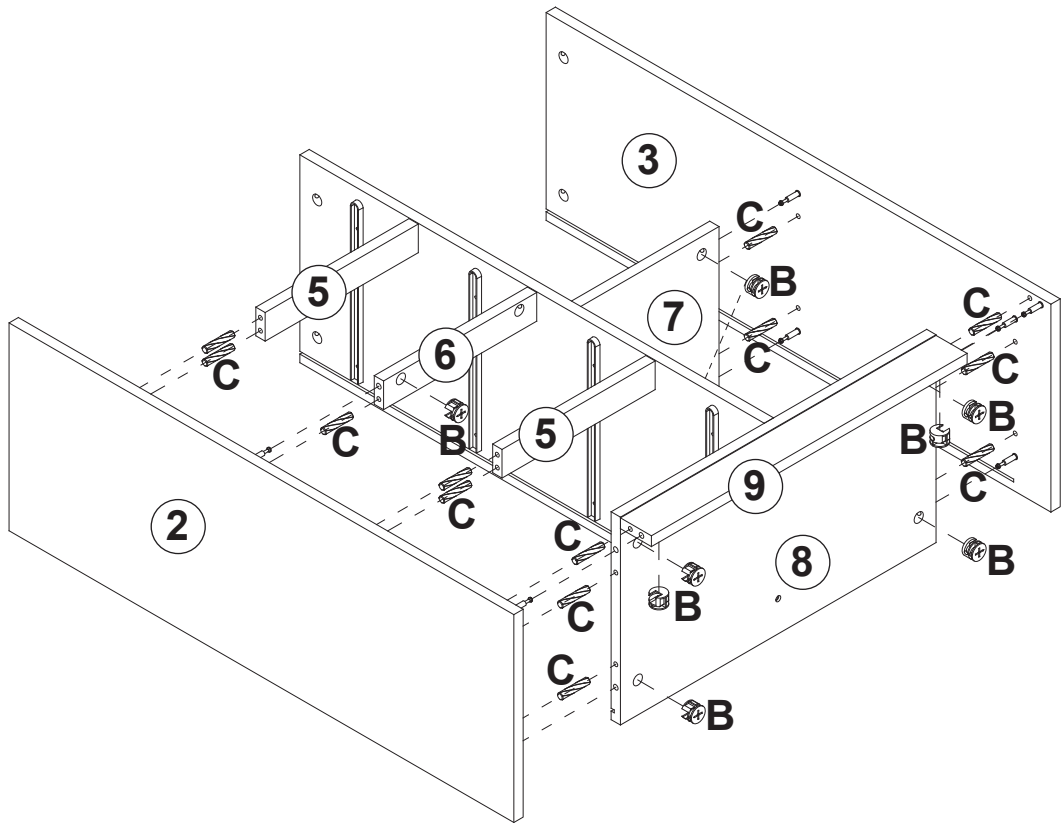
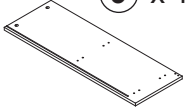

B x 6



C x 6



1 x 1

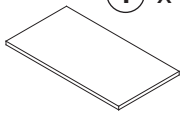

11 x 2

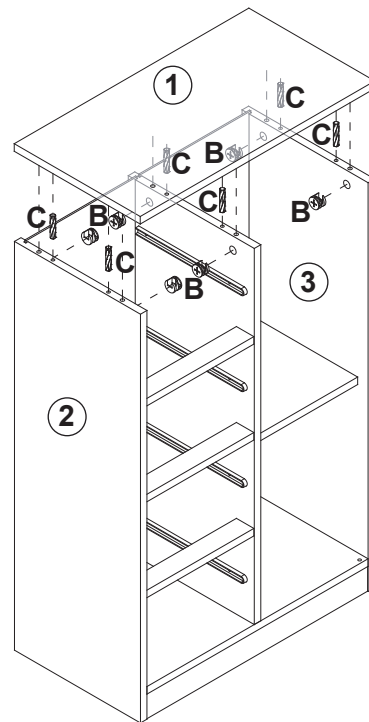
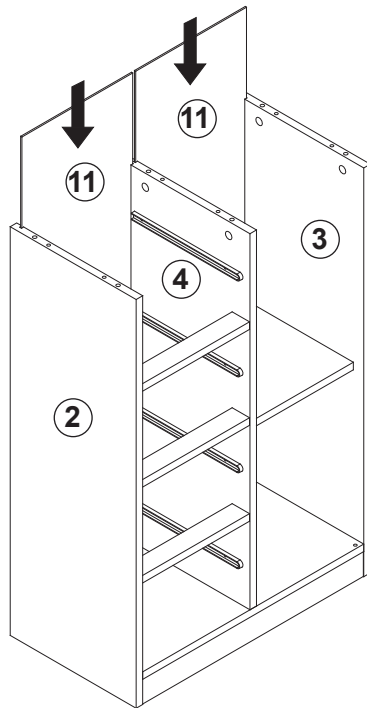
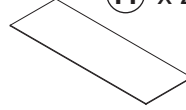

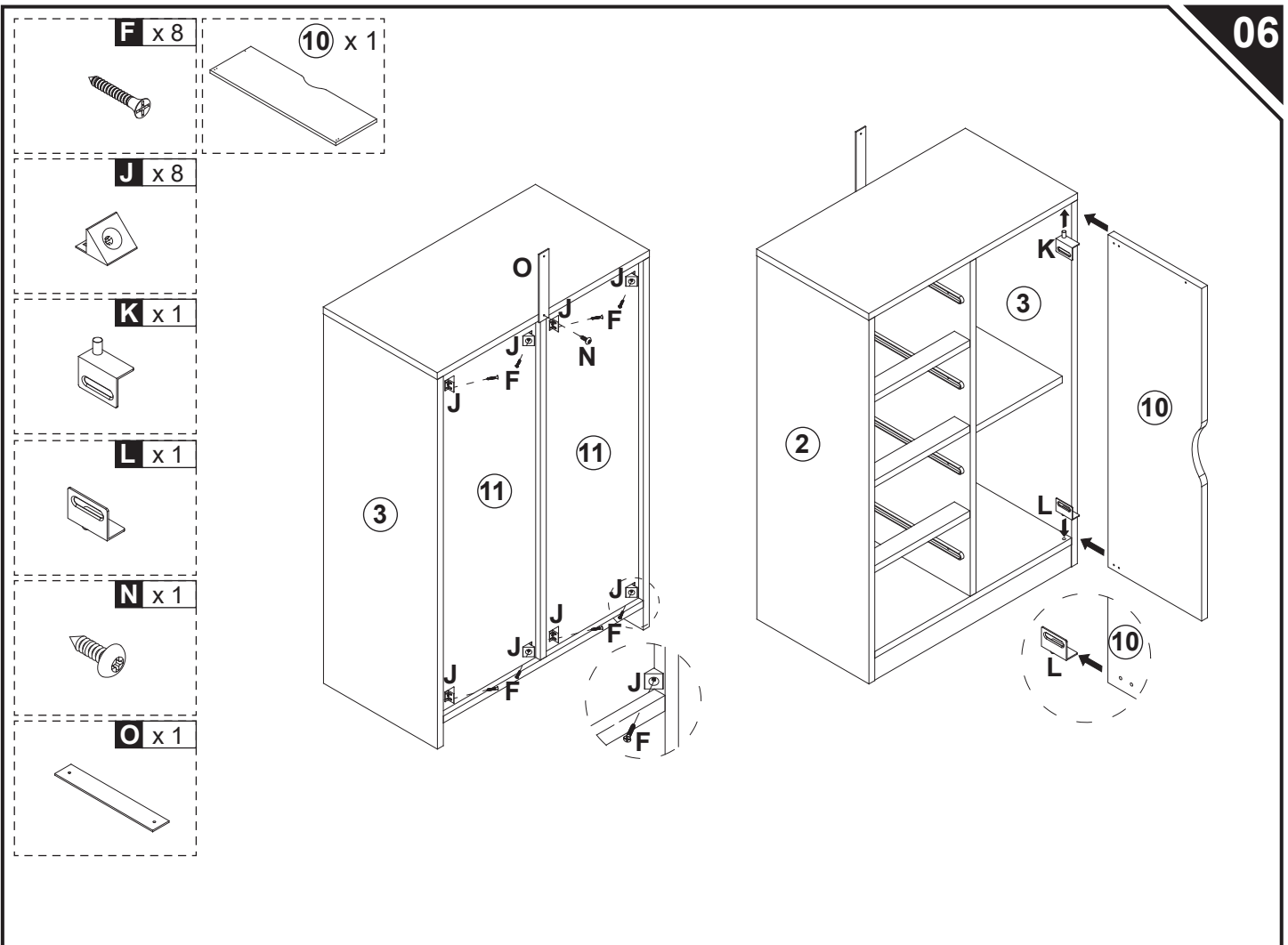
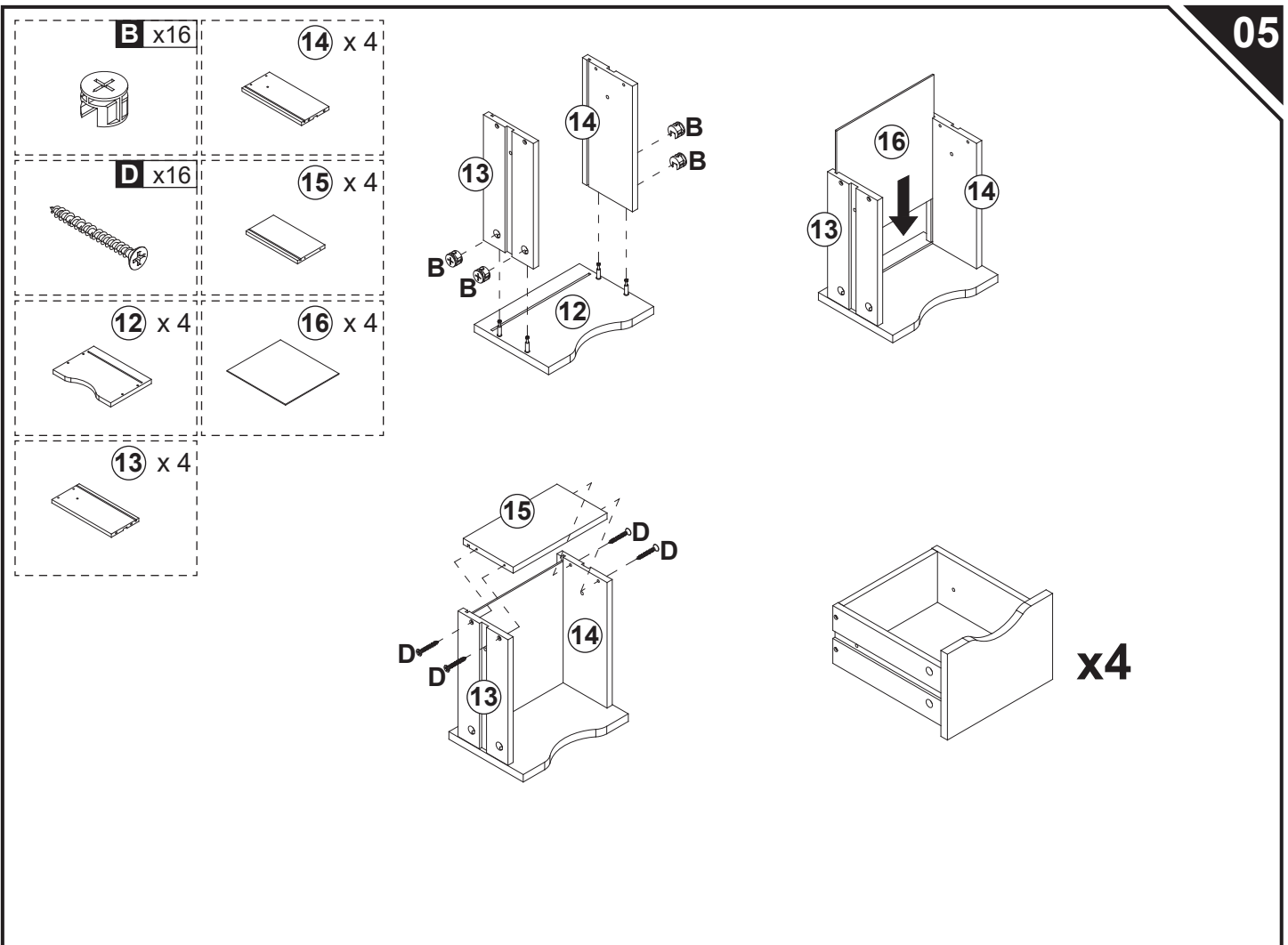

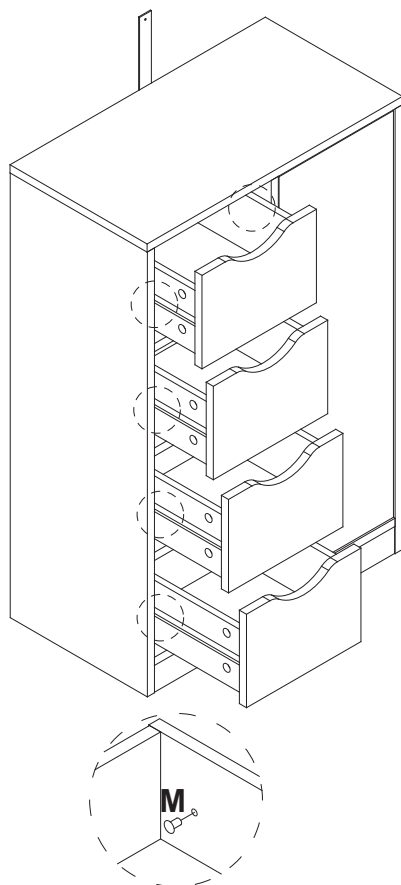
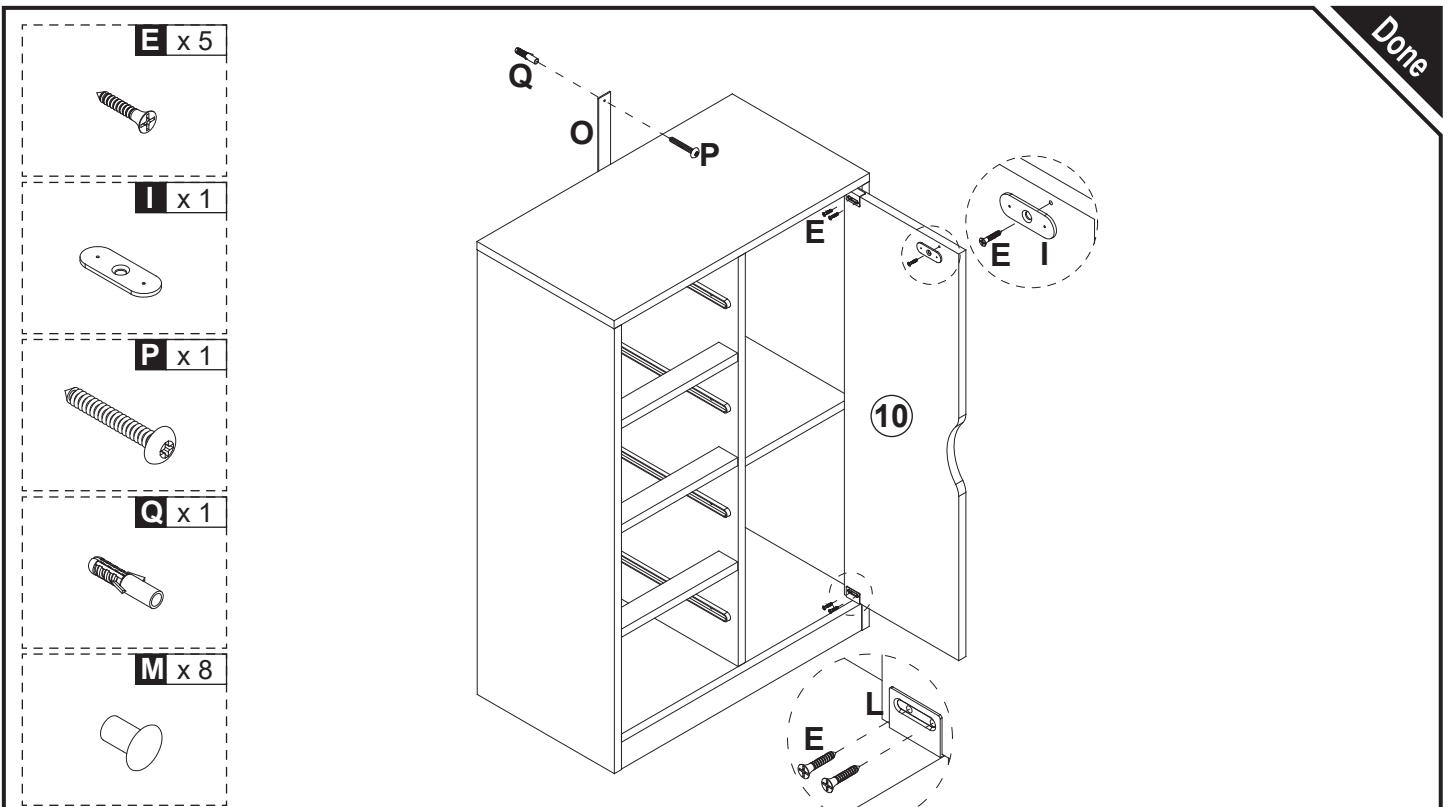

EN_ Be careful to push in the board when the both sides slide way been aligned.

FR_ Prenez soin d'enfoncer la planche lorsque les deux côtés de la glissière sont alignés.

ES_ Empuje con cuidado el tablero después de que los dos lados se hayan alineado.

DE_ Achten Sie darauf, dass Sie die Platte einschieben, wenn die beiden Seiten so ausgerichtet sind, dass sie gleiten.

IT_ Fare attenzione quando si spinge il cassetto quando le due guide di scorrimento sono state allineati.