

PawHut!

IN221000151V01_GL

D51-334V00

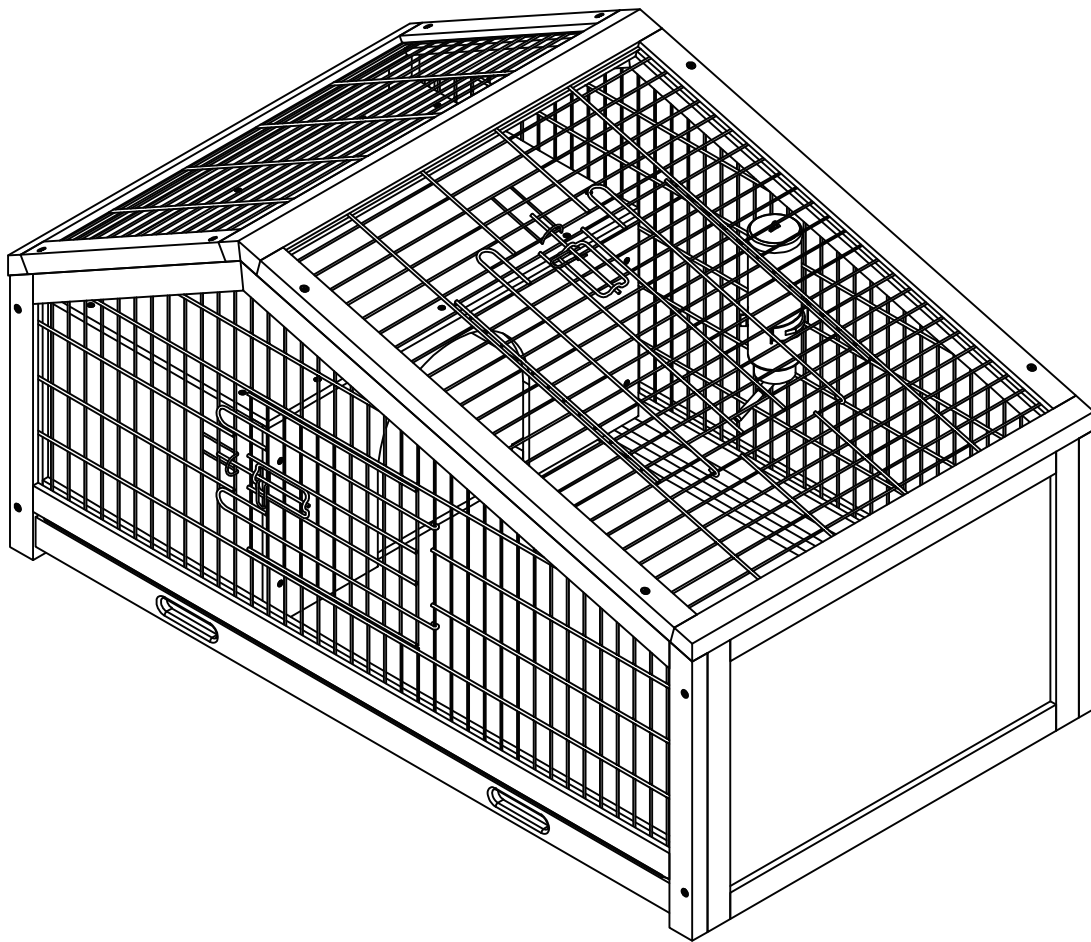

EN_IMPORTANT, RETAIN FOR FUTURE REFERENCE: READ CAREFULLY.

FR_IMPORTANT: A LIRE ATTENTIVEMENT ET À CONSERVER POUR CONSULTATION ULTÉRIEURE.

ES_IMPORTANTE, LEA Y GUARDE PARA FUTURAS REFERENCIAS.

PT_IMPORTANTE, RETER PARA REFERÊNCIA FUTURA: LEIA ATENTAMENTE.

DE_WICHTIG! SORGFÄLTIG LESEN UND FÜR SPÄTER NACHSCHLAGEN AUFBEWAHREN.

IT_IMPORTANTE! CONSERVARE IL PRESENTE MANUALE PER FUTURO RIFERIMENTO E LEGGERLO ATTENTAMENTE.

EN

Dear customer,

Thank you for purchasing this product. So that your appliance serves you well, please read all the instructions in this user's manual. If you have any questions, please contact our customer care center, Our contact details are below:

FR

Cher client,

Nous vous remercions d'avoir acheté ce produit. Afin que vous puissiez profiter pleinement de votre appareil, veuillez lire toutes les instructions de ce manuel d'utilisation. Si vous avez la moindre question, veuillez contacter notre centre d'assistance à la clientèle, Nos coordonnées sont les suivantes:

DE

Sehr geehrter Kunde,

Vielen Dank, dass Sie dieses Produkt erworben haben. Damit Ihr Gerät Ihnen gute Dienste leistet, lesen Sie bitte alle Hinweise in diesem Benutzerhandbuch. Wenn Sie Fragen haben, wenden Sie sich bitte an unser Kundendienstzentrum, Unsere Kontaktdaten stehen unten:

ES

Queridos clientes,

Gracias por comprar este producto. Para que su electrodoméstico le sirva mejor, lea todas las instrucciones de este manual del usuario. Si tiene alguna pregunta, comuníquese con nuestro Centro de Atención al Cliente, Nuestros datos de contacto son los siguientes:

PT

Caros clientes,

Obrigado por adquirir este produto. Para que o seu aparelho o sirva melhor, leia todas as instruções deste manual do utilizador. Se tiver alguma dúvida, por favor contacte o nosso Centro de Atendimento ao Cliente, Os nossos dados de contacto são os seguintes:

IT

Caro Cliente,

Grazie per aver acquistato questo prodotto. Per servirti meglio con questo apparecchio ti prego di leggere tutte le istruzioni in presente manuale utente. In caso di dubbio, si prega di contattare il nostro centro assistenza clienti, I nostri dettagli di contatto sono di seguito:

| Country |  Phone |  Email |
|---------|---|---|
| US | 001-877-644-9366 | customerservice@aosom.com |
| CA | 416-792-6088 | customerservice@aosom.ca |
| UK | 0044-800-240-4004 | enquiries@mhstar.co.uk |
| DE | 0049-0(40)-88307530 | service@aosom.de |
| FR | 0033-1-84166106 | aosom@mhfrance.fr |
| ES | 0034-931294512 | atencioncliente@aosom.es |
| PT | 0034-931294512 | info@aosom.pt |
| IT | 0039-0249471447 | clienti@aosom.it |

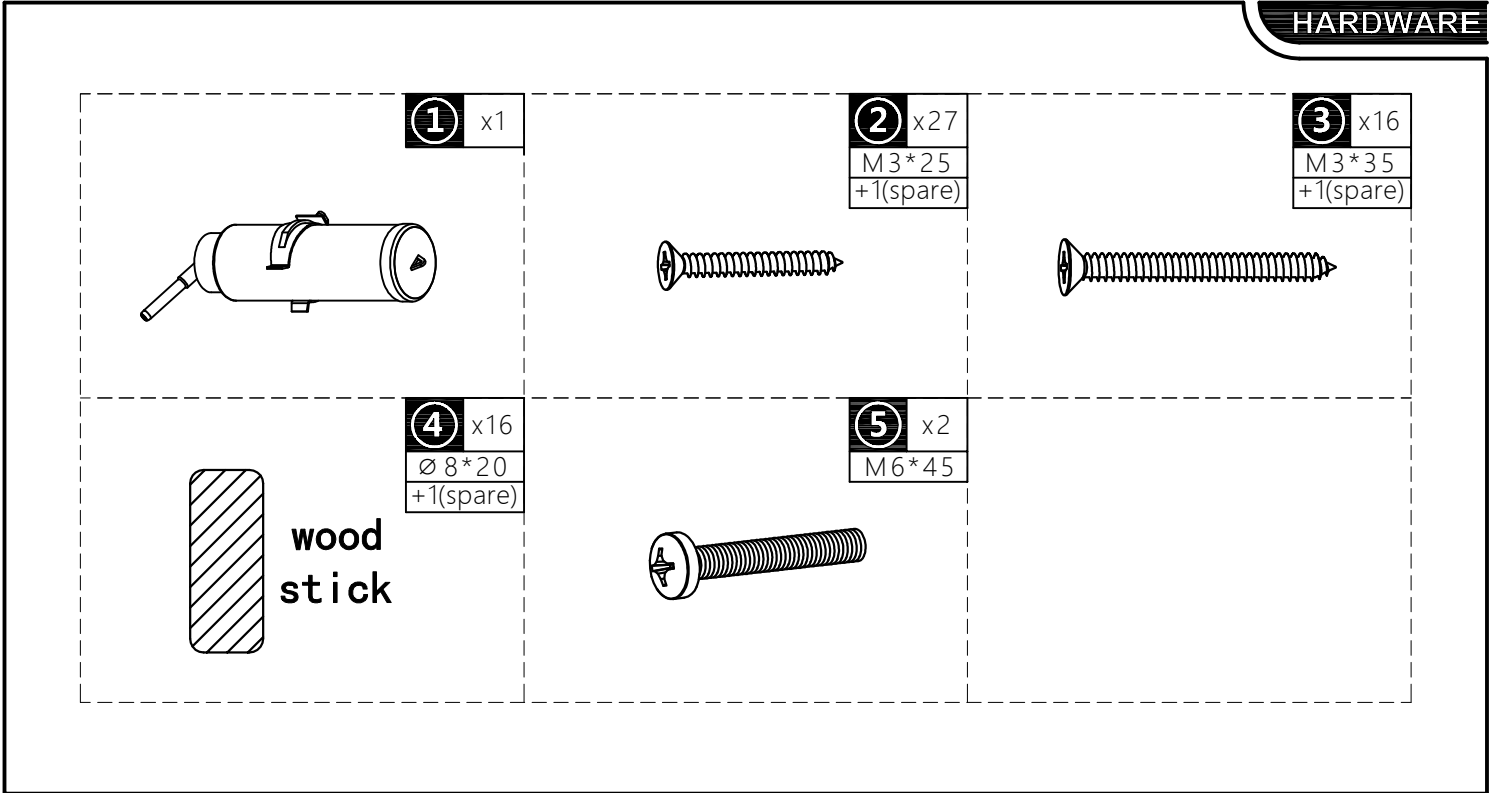
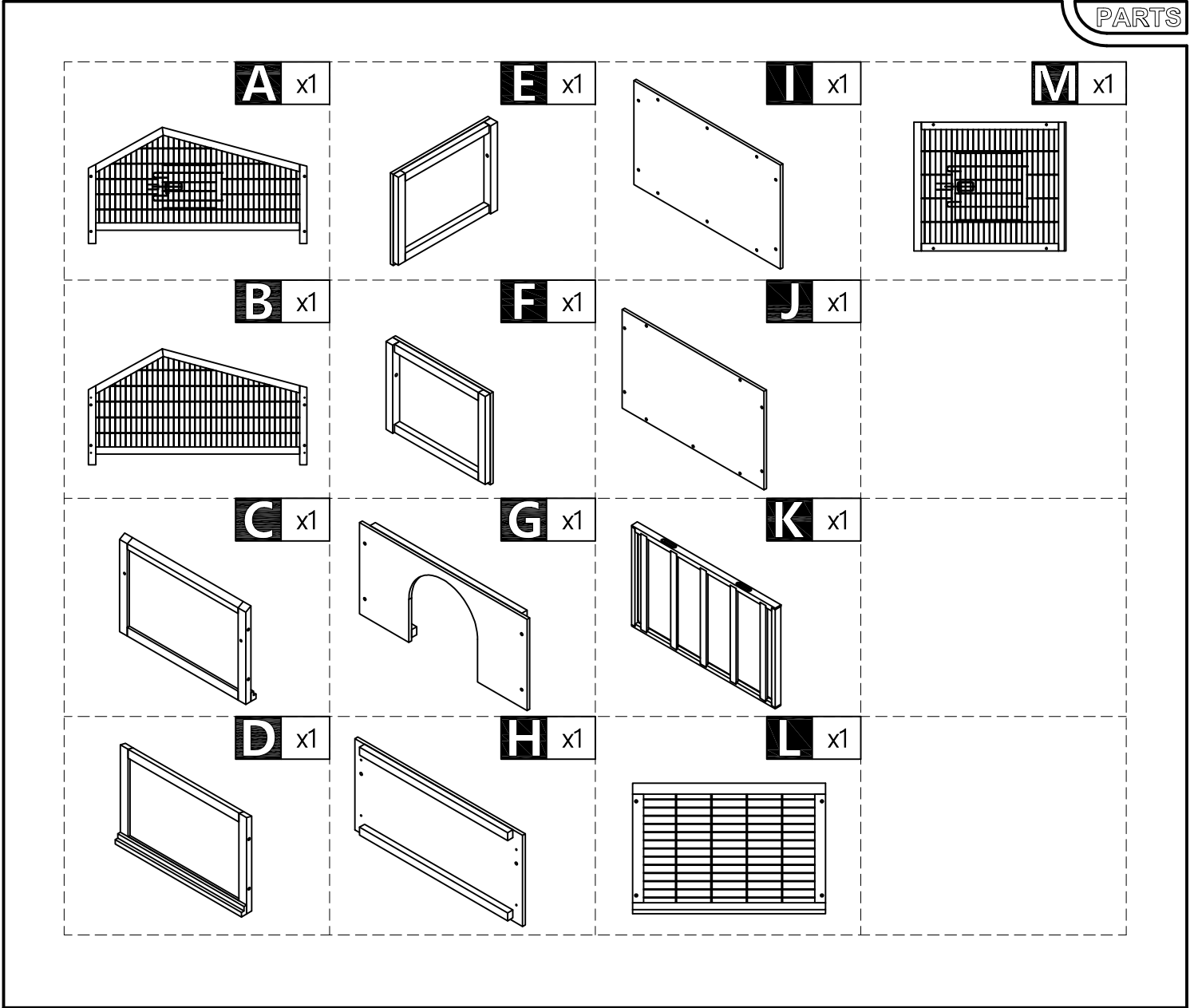

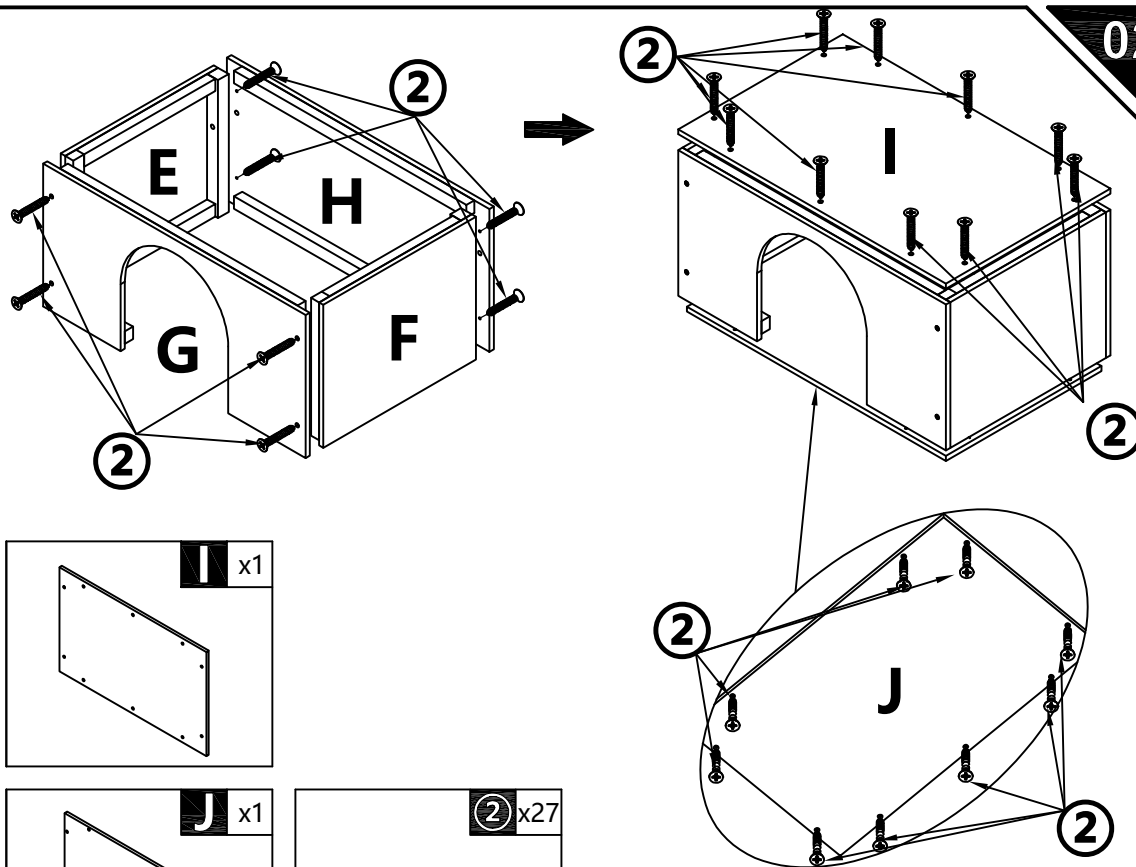
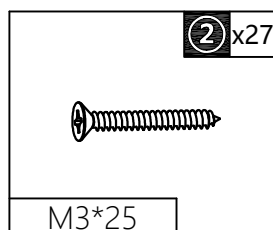
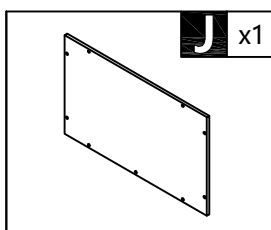
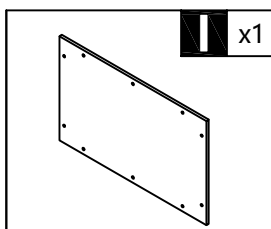
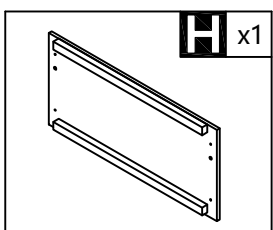
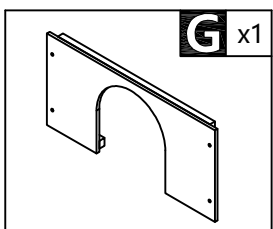
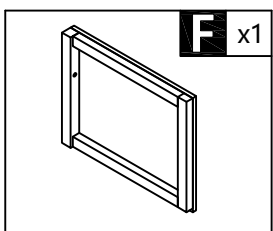
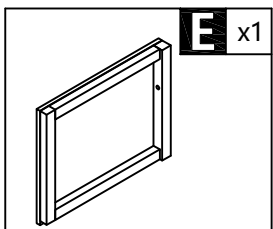
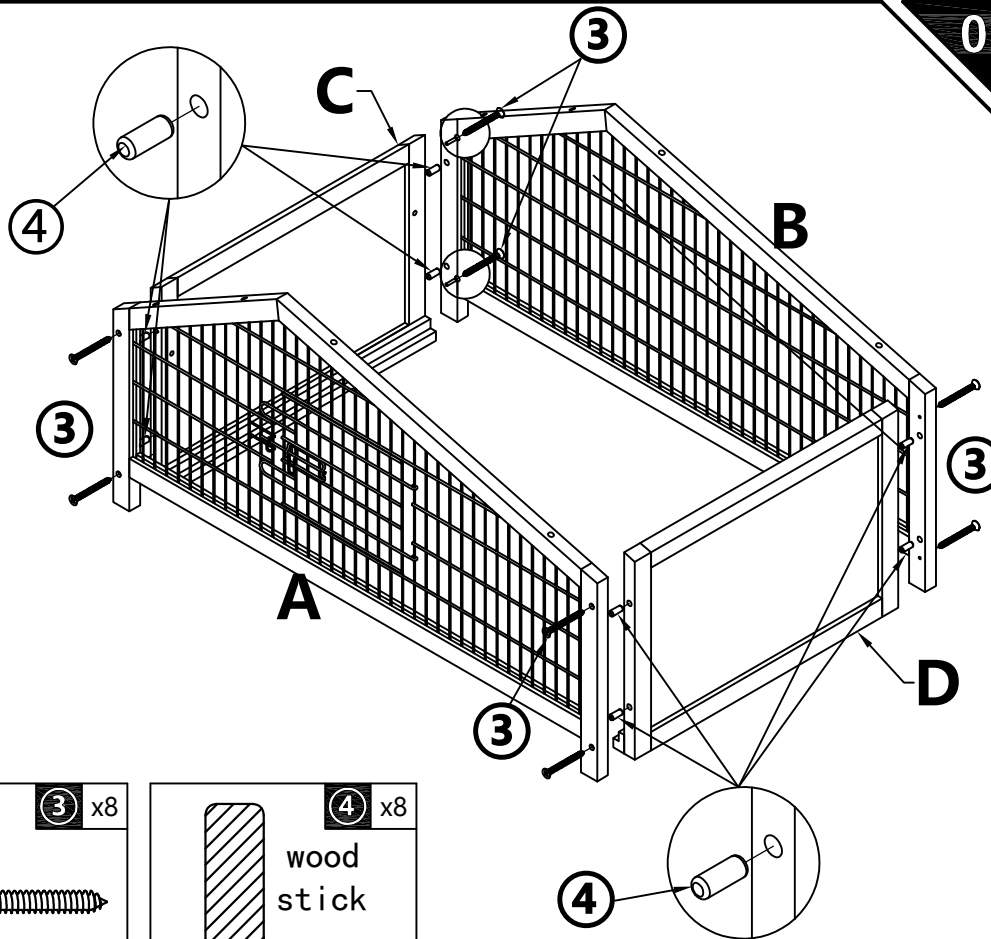
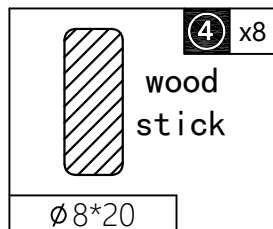
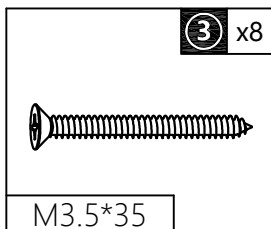
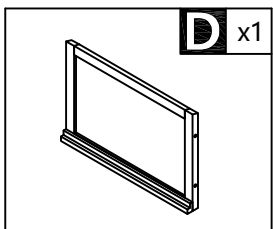
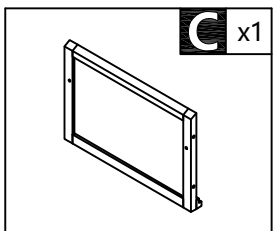
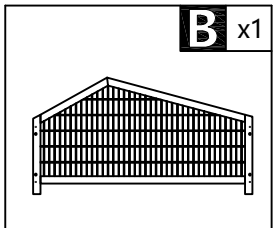
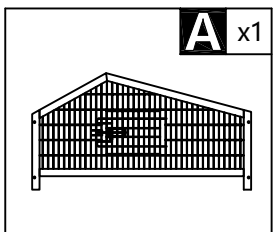

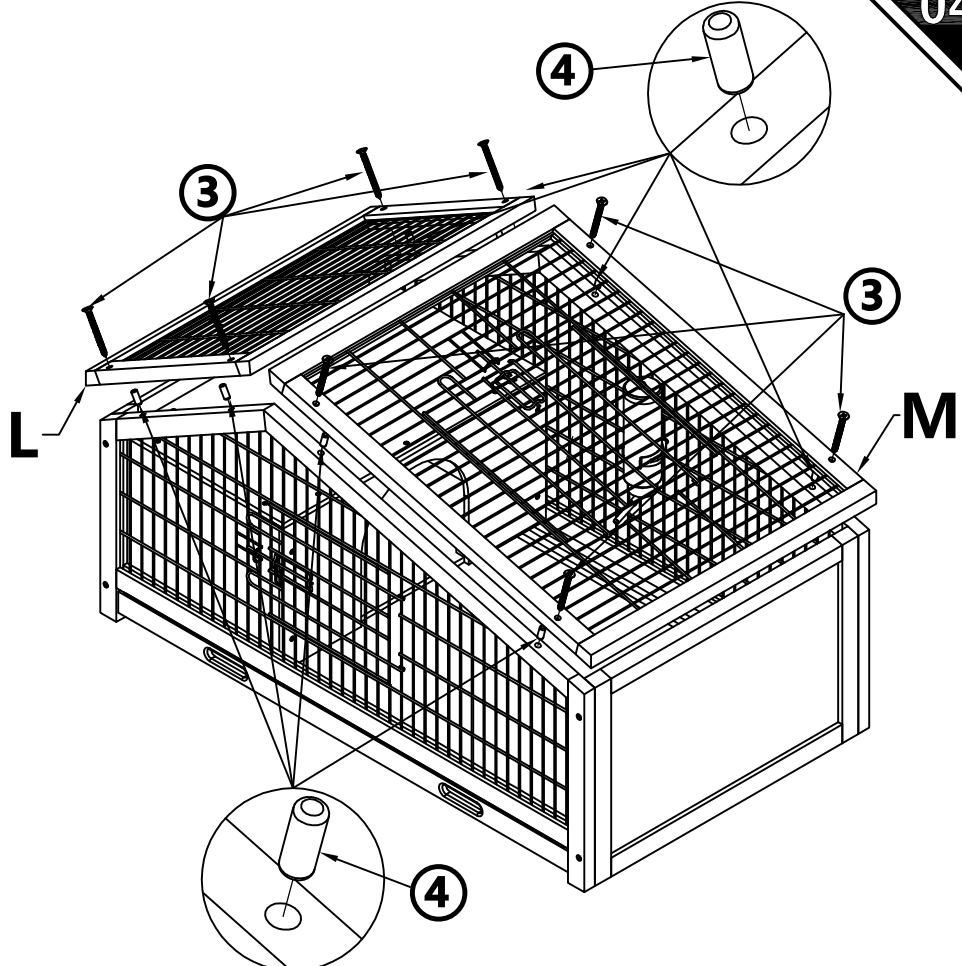
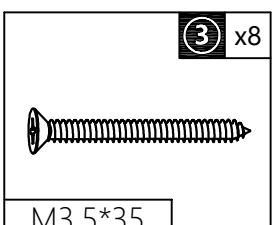
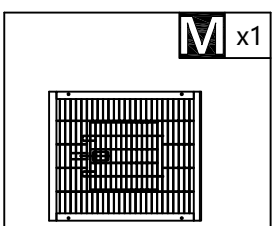
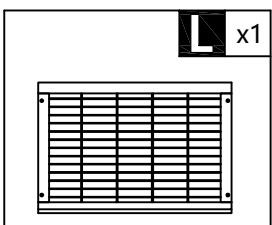
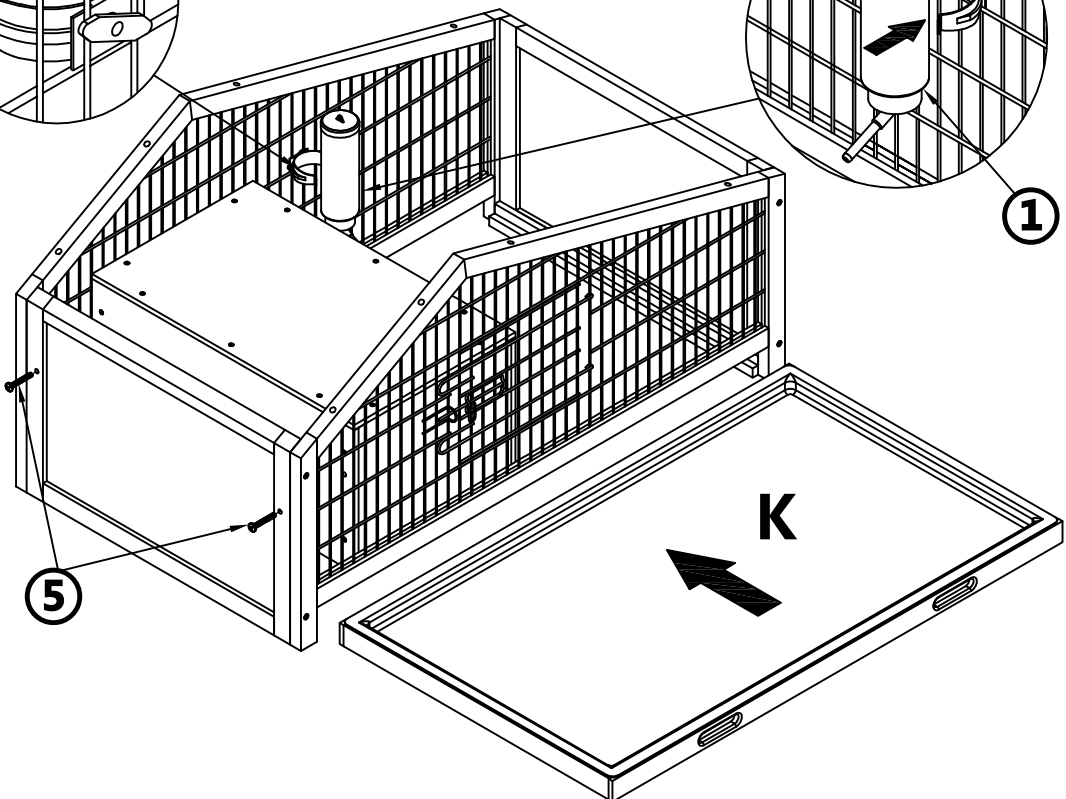
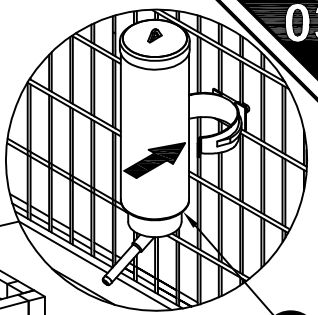
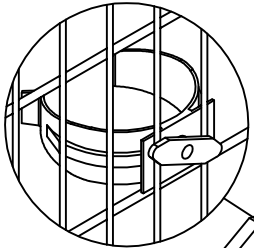
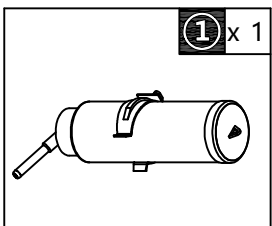
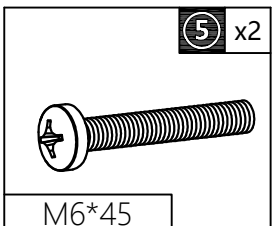
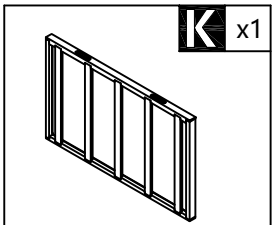

US

Imported by Aosom LLC
27150 SW Kinsman Rd Wilsonville, OR 97070 USA
MADE IN CHINA

CA

Imported by Aosom Canada Inc.
1251 Tapscott Road, Unit 101, Scarborough, Ontario Canada M1X 1S9
MADE IN CHINA

Importé par Aosom Canada Inc.
1251 Rue Tapscott, Unité 101, Scarborough, Ontario Canada M1X 1S9
FABRIQUÉ EN CHINE

UK

IMPORTER ADDRESS:
MH STAR UK LTD
Unit 27, Perivale Park,
Horsenden lane South
Perivale, UB6 7RH
MADE IN CHINA

FR

ADRESSE D'IMPORTATION:
MH FRANCE
2 Rue Maurice Hartmann
92130 Issy Les Moulineaux
France
FABRIQUÉ EN CHINE

ES

IMPORTADOR:
SPANISH AOSOM, S.L.
C/ROC GROS,Nº15.08550, ELS HOSTALET DE BALENYÀ, SPAIN.
B66295775
WWW.AOSOM.ES
ATENCIONCLIENTE@AOSOM.ES
TEL: 931294512
HECHO EN CHINA

DE

ADRESSE DES IMPORTEURS:
MH Handel GmbH
Wendenstraße 309
D-20537 Hamburg
Germany
IN CHINA HERGESTELLT

IT

IMPORTATO DA:
AOSOM Italy srl
Centro Direzionale Milanofiori
Strada 1 Palazzo F1
20057 Assago (MI)
P.I.: 08567220960
FATTO IN CINA