

**EN\_IMPORTANT, RETAIN FOR FUTURE REFERENCE: READ CAREFULLY.**

**FR\_IMPORTANT: A LIRE ATTENTIVEMENT ET À CONSERVER POUR CONSULTATION ULTÉRIEURE.**

**ES\_IMPORTANTE, LEA Y GUARDE PARA FUTURAS REFERENCIAS.**

**DE\_WICHTIG! SORGFÄLTIG LESEN UND FÜR SPÄTER NACHSCHLAGEN AUFBEWAHREN.**

**IT\_IMPORTANTE! CONSERVARE IL PRESENTE MANUALE PER FUTURO RIFERIMENTO E LEGGERLO ATTENTAMENTE.**

EN

**Dear customer,**

Thank you for purchasing this product. So that your appliance serves you well, please read all the instructions in this user's manual. If you have any questions, please contact our customer care center, Our contact details are below:

FR

**Cher client,**

Nous vous remercions d'avoir acheté ce produit. Afin que vous puissiez profiter pleinement de votre appareil, veuillez lire toutes les instructions de ce manuel d'utilisation. Si vous avez la moindre question, veuillez contacter notre centre d'assistance à la clientèle, Nos coordonnées sont les suivantes:

DE

**Sehr geehrter Kunde,**

Vielen Dank, dass Sie dieses Produkt erworben haben. Damit Ihr Gerät Ihnen gute Dienste leistet, lesen Sie bitte alle Hinweise in diesem Benutzerhandbuch. Wenn Sie Fragen haben, wenden Sie sich bitte an unser Kundendienstzentrum, Unsere Kontaktdaten stehen unten:

ES

**Queridos clientes,**

Gracias por comprar este producto. Para que su electrodoméstico le sirva mejor, lea todas las instrucciones de este manual del usuario. Si tiene alguna pregunta, comuníquese con nuestro Centro de Atención al Cliente, Nuestros datos de contacto son los siguientes:

PT



**Caros clientes,**















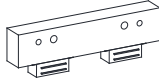
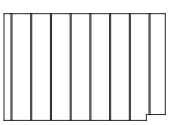
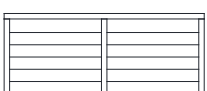
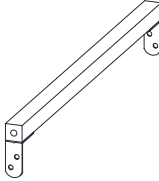

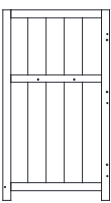
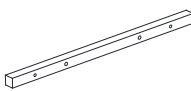
Obrigado por adquirir este produto. Para que o seu aparelho o sirva melhor, leia todas as instruções deste manual do utilizador. Se tiver alguma dúvida, por favor contacte o nosso Centro de Atendimento ao Cliente, Os nossos dados de contacto são os seguintes:

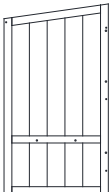
IT

**Caro Cliente,**

Grazie per aver acquistato questo prodotto. Per servirti meglio con questo apparecchio ti prego di leggere tutte le istruzioni in presente manuale utente. In caso di dubbio, si prega di contattare il nostro centro assistenza clienti, I nostri dettagli di contatto sono di seguito:

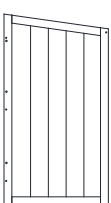
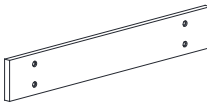
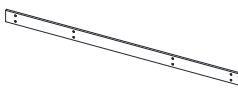
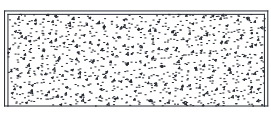
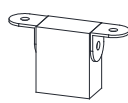
Country	 Phone	 Email
US	001-877-644-9366	customerservice@aosom.com
CA	416-792-6088	customerservice@aosom.ca
UK	0044-800-240-4004	enquiries@mhstar.co.uk
DE	0049-0(40)-88307530	service@aosom.de
FR	0033-1-84166106	aosom@mhfrance.fr
ES	0034-931294512	atencioncliente@aosom.es
PT	0034-931294512	info@aosom.pt
IT	0039-0249471447	clienti@aosom.it

<p><b>BOX 1-2</b></p>  <p><b>1</b> x 1</p>	<p><b>BOX 2-2</b></p>  <p><b>3</b> x 1</p>	 <p><b>16</b> x 1</p>
 <p><b>2</b> x 1</p>	 <p><b>4</b> x 1</p>	 <p><b>17</b> x 2</p>
 <p><b>10</b> x 1</p>	 <p><b>5</b> x 1</p>	 <p><b>18</b> x 2</p>
 <p><b>11</b> x 1</p>	 <p><b>6</b> x 1</p>	 <p><b>19</b> x 2</p>
 <p><b>12</b> x 2</p>	 <p><b>7</b> x 1</p>	 <p><b>20</b> x 2</p>
 <p><b>14</b> x 1</p>	 <p><b>8</b> x 1</p>	 <p><b>21</b> x 2</p>
 <p><b>15</b> x 1</p>	 <p><b>9</b> x 1</p>	 <p><b>22</b> x 2</p>
 <p><b>23</b> x 2</p>	 <p><b>13</b> x 1</p>	<p><b>24</b> x 1</p>   <p>Hardware Kit</p>

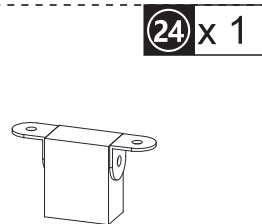
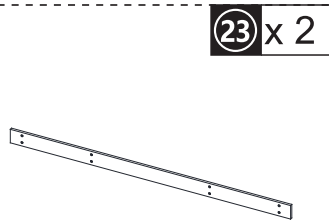
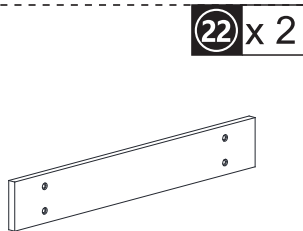
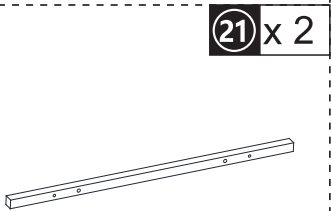
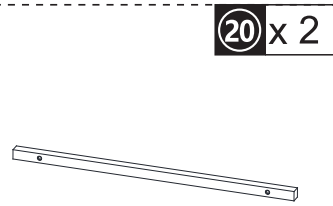
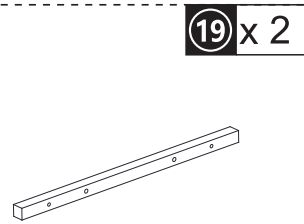
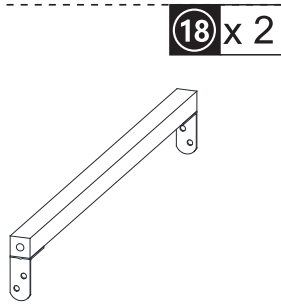
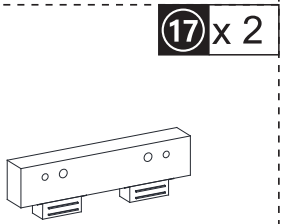
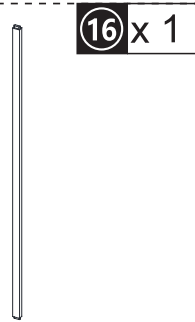
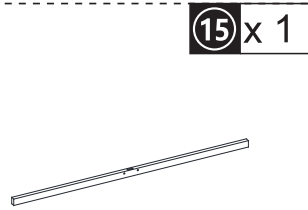
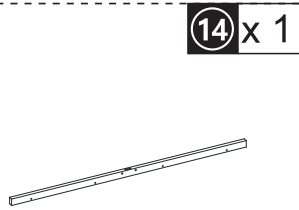
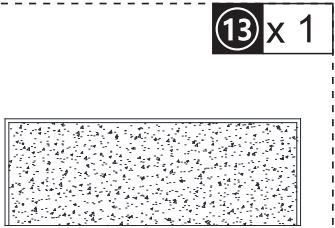
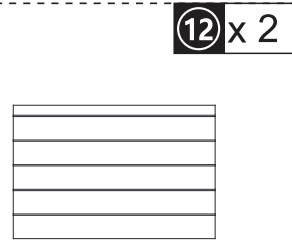
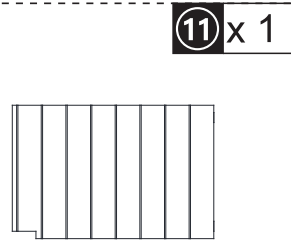
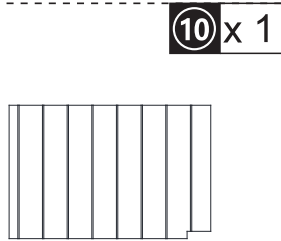
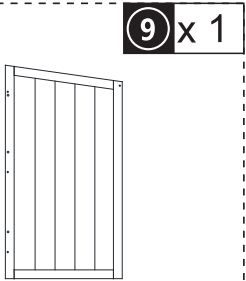
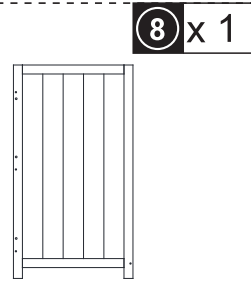
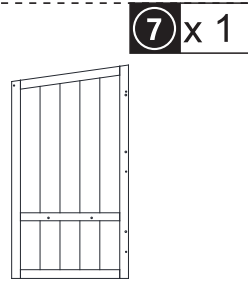
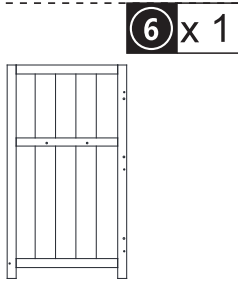
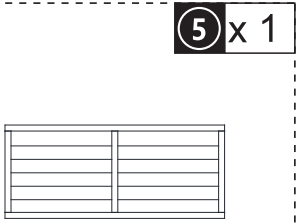
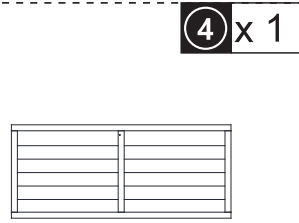
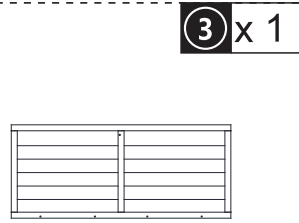
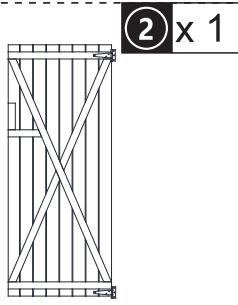
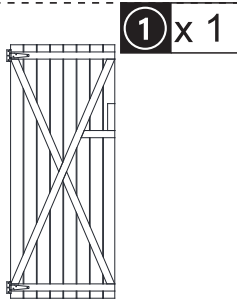

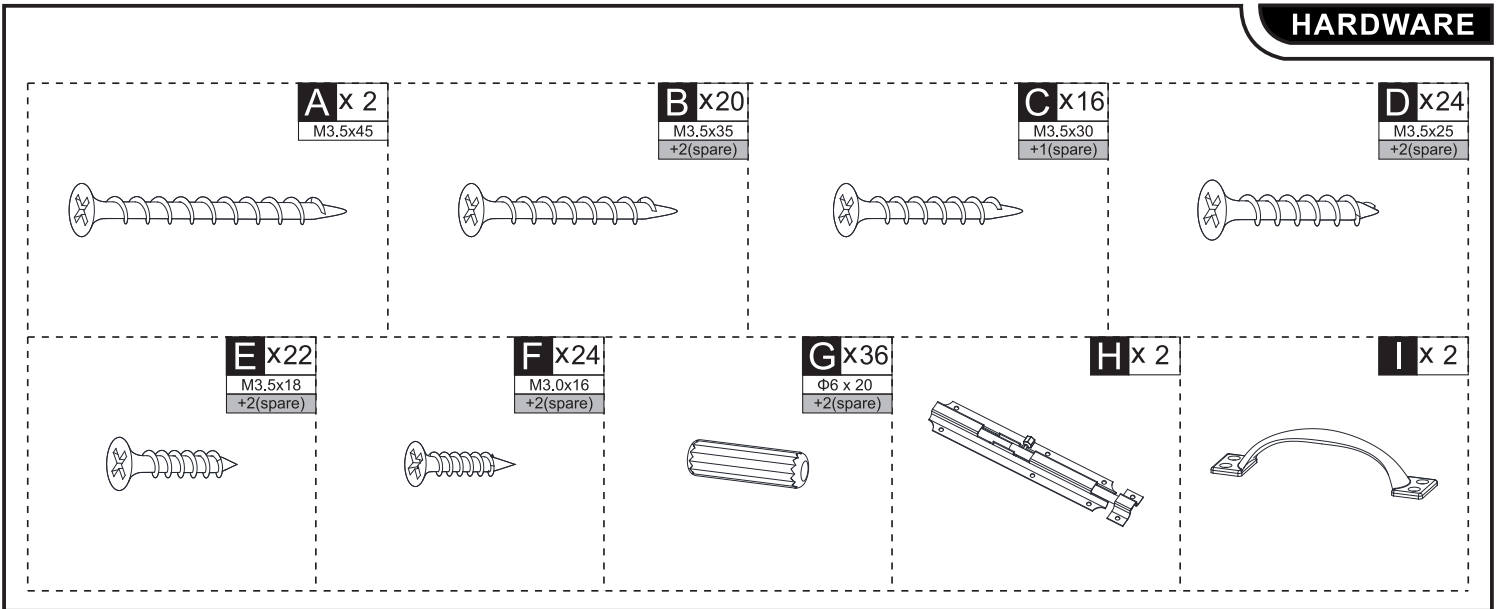

**NOTE**

**EN** Do not confuse similar screws. Do not tighten bolts fully until all parts are connected!

**FR** Ne pas confondre des vis similaires. Ne serrez pas les boulons à fond tant que toutes les pièces ne sont pas connectées!

**ES** No confunda tornillos similares. No apriete los tornillos completamente hasta que todas las partes están conectadas!

**DE** Verwechseln Sie ähnliche Schrauben nicht. Ziehen Sie die Schrauben erst fest an, wenn alle Teile verbunden sind!

**IT** Non confondere le viti simili. non serrare completamente i bulloni fino a tutte le parti non sono ancora collegate!

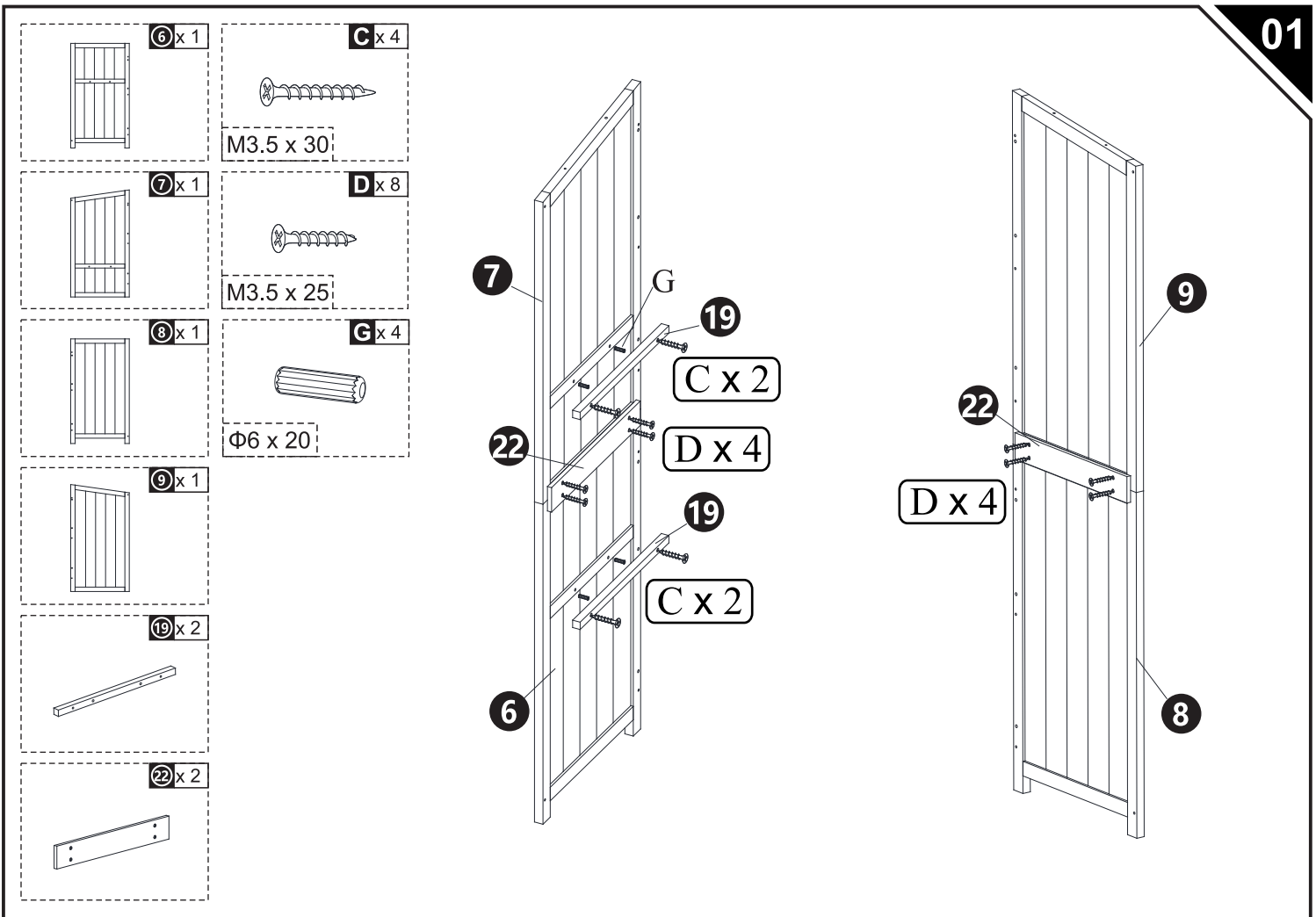

3 x 1

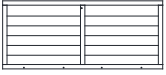

21 x 2



C x 4



M3.5 x 30

C x 8



Φ6 x 20

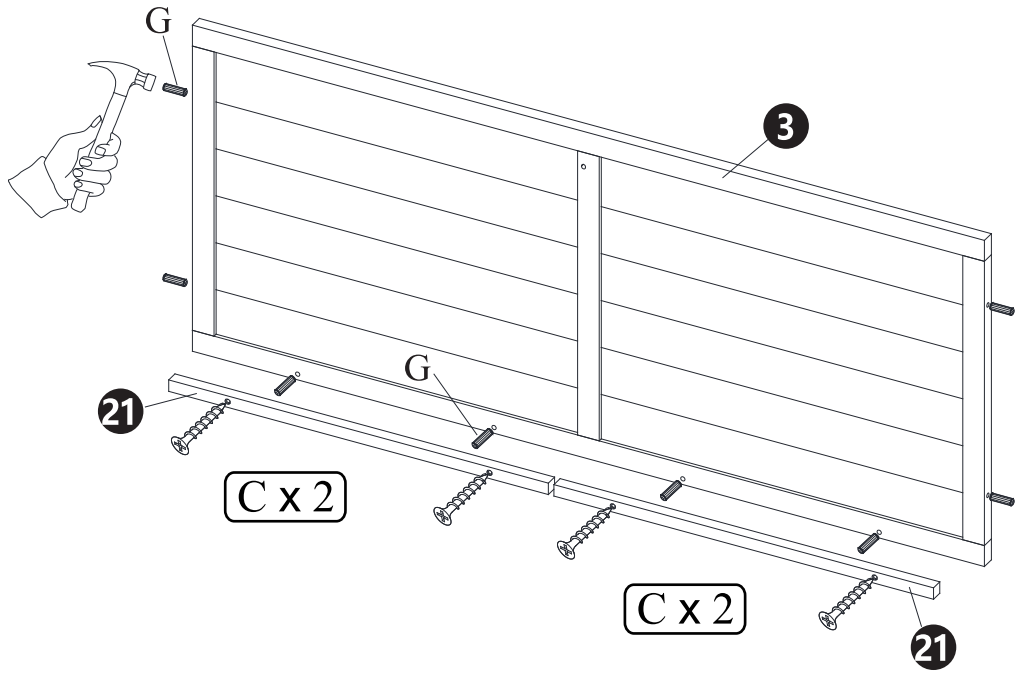

B x 4



M3.5 x 35

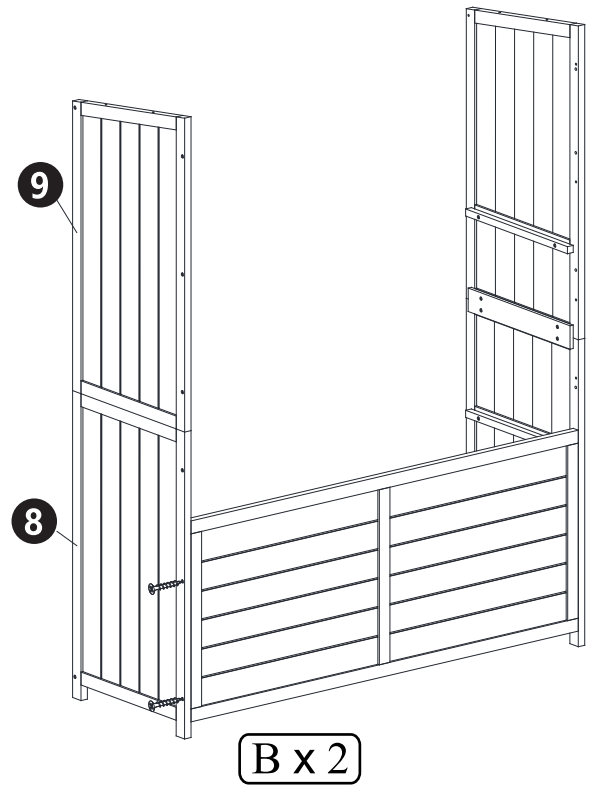
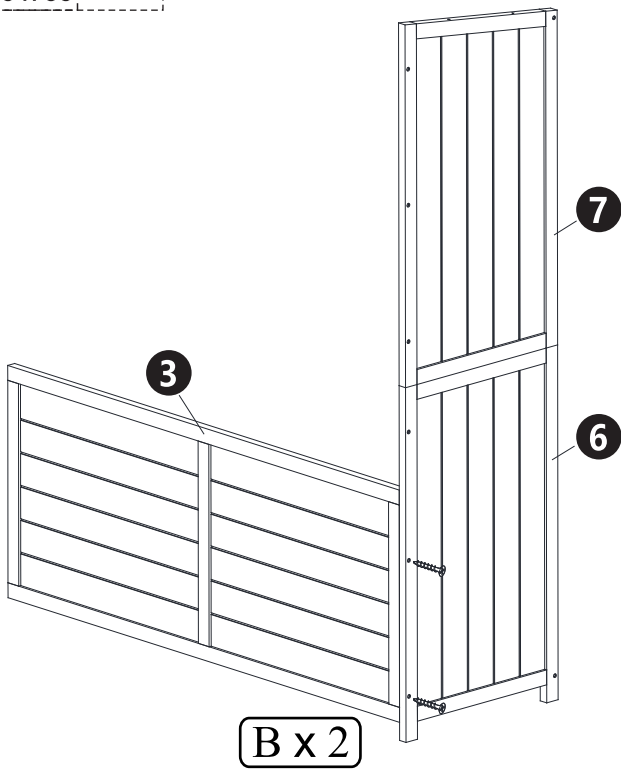

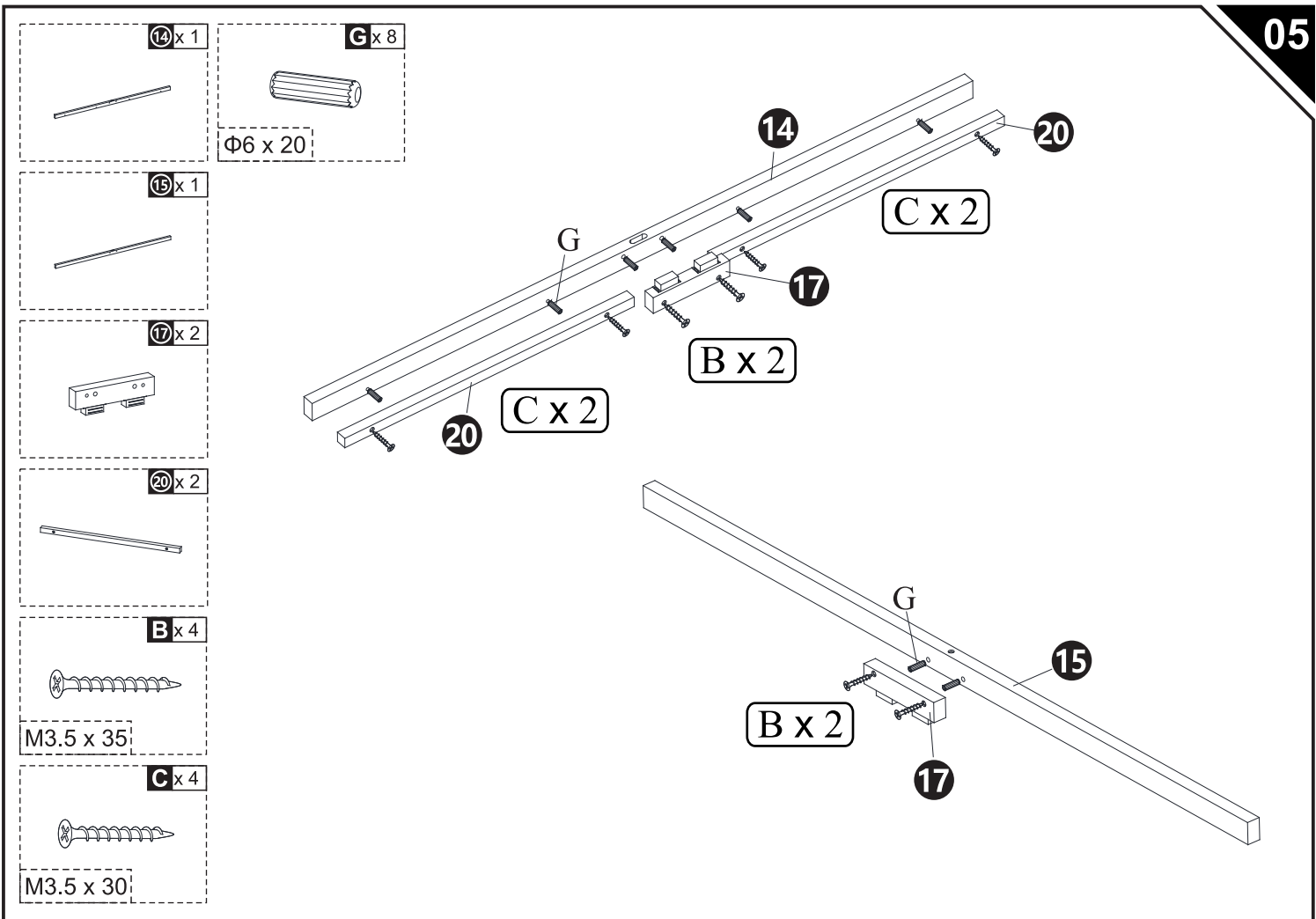
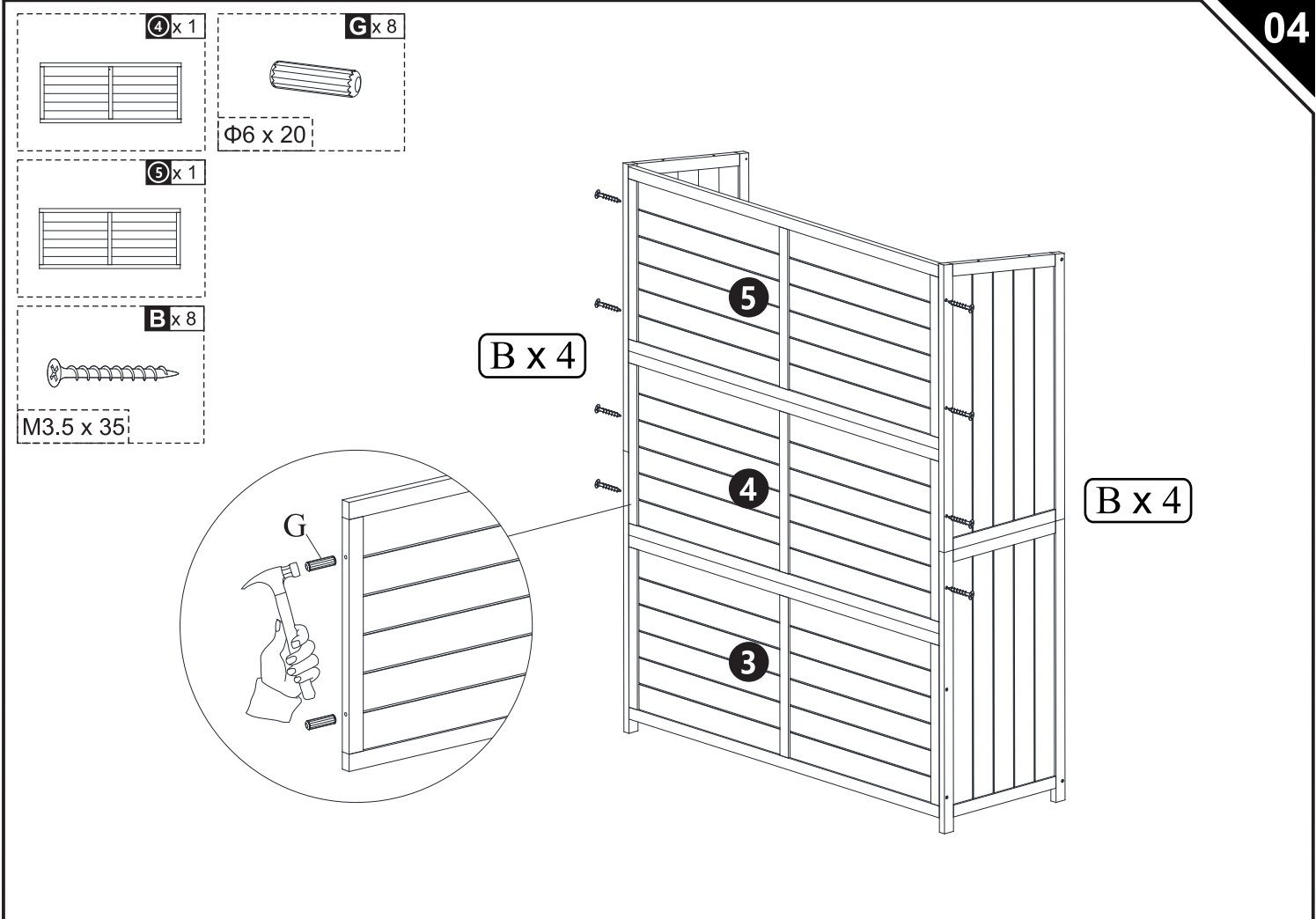

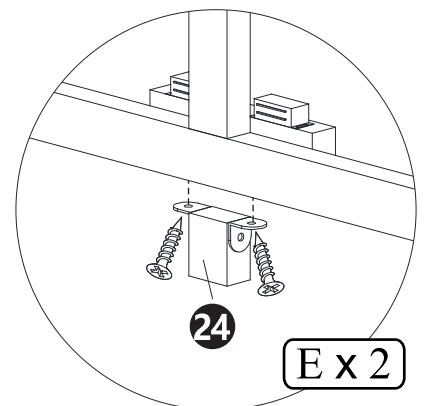
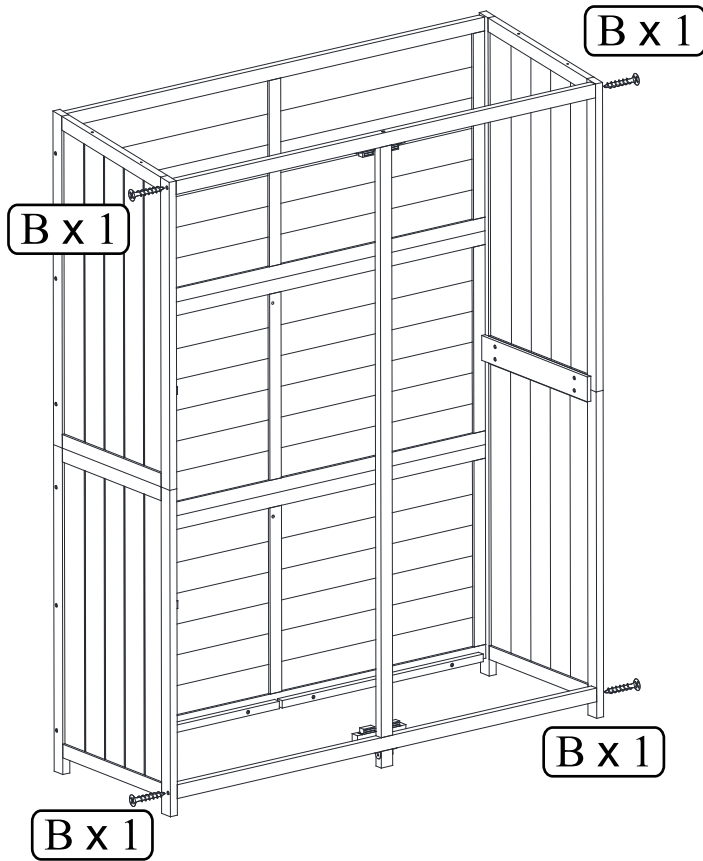
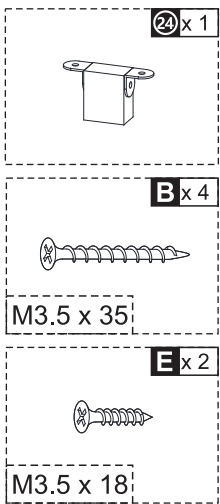
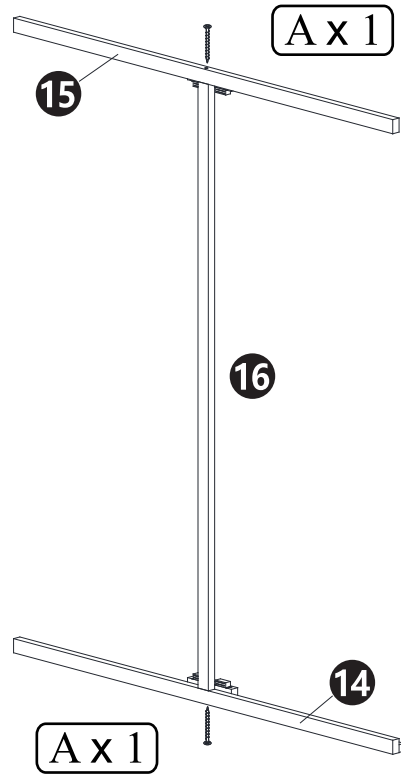
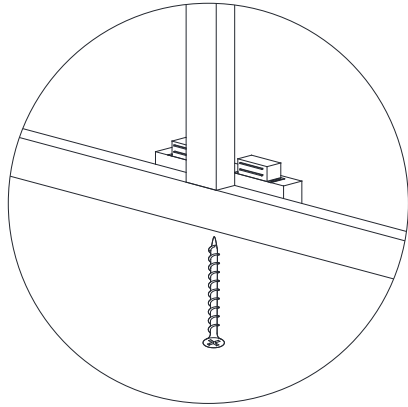
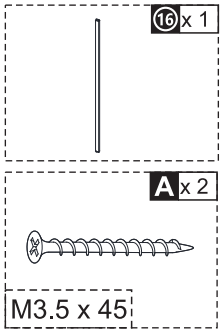



23 x 2

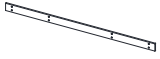

D x 16



M3.5 x 25

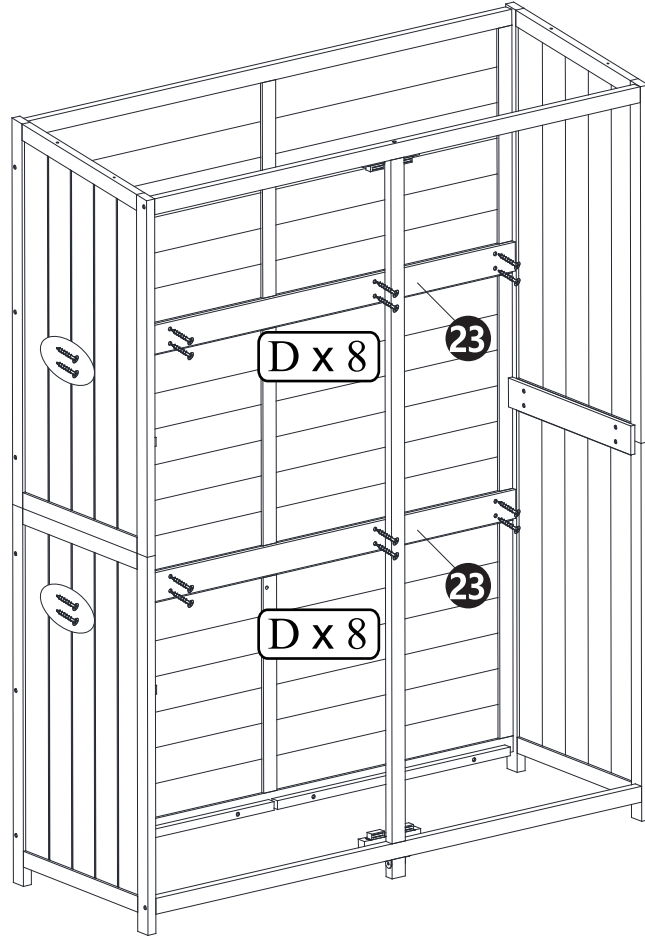

18 x 2

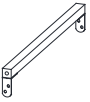

E x 8







M3.5 x 18

G x 4

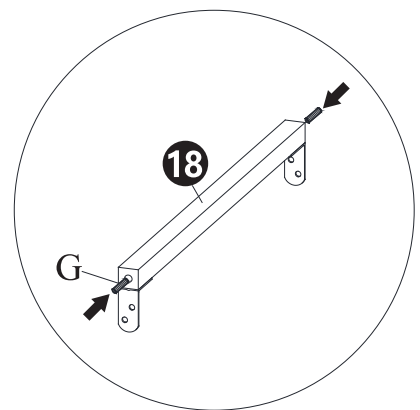
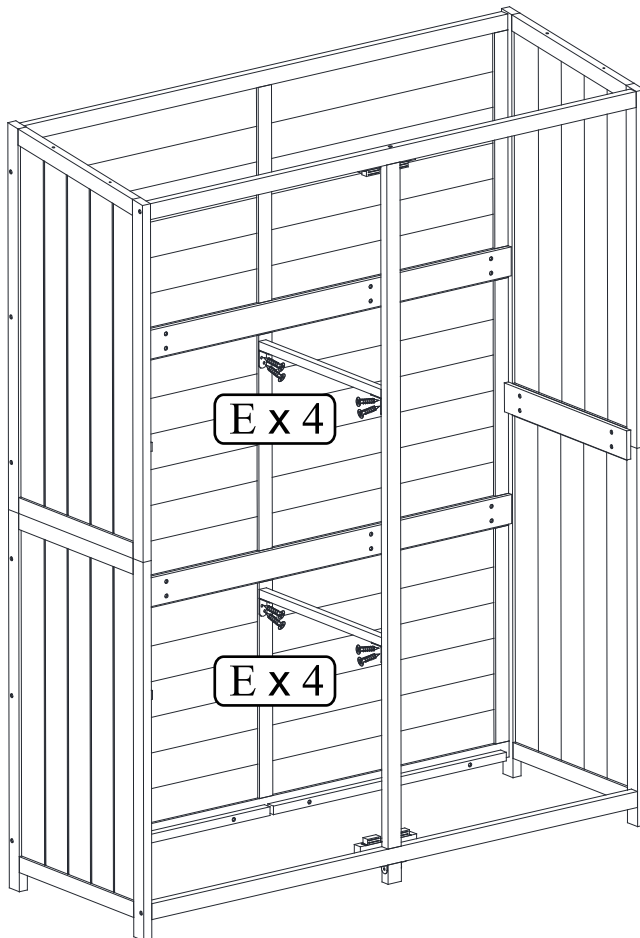



Φ6 x 20

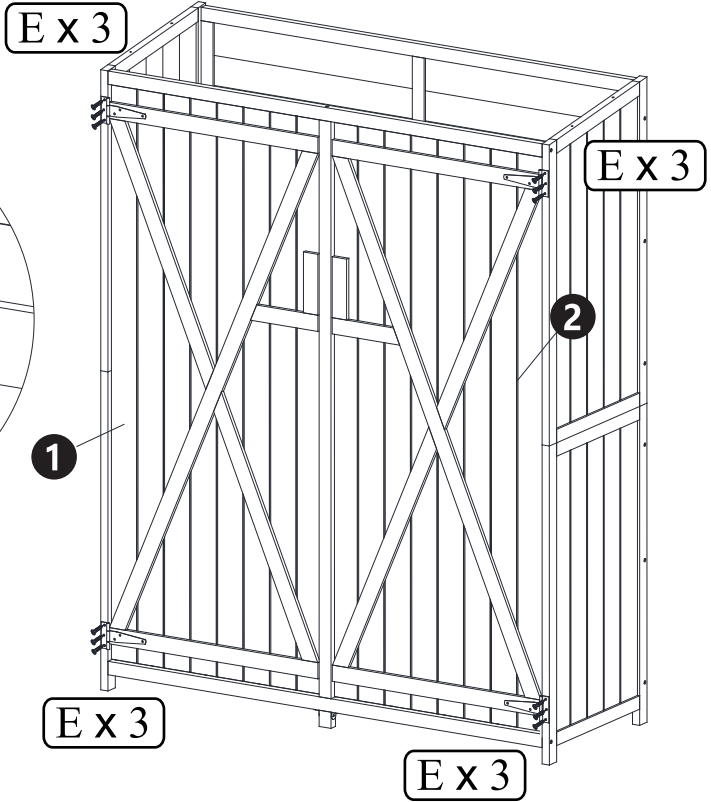
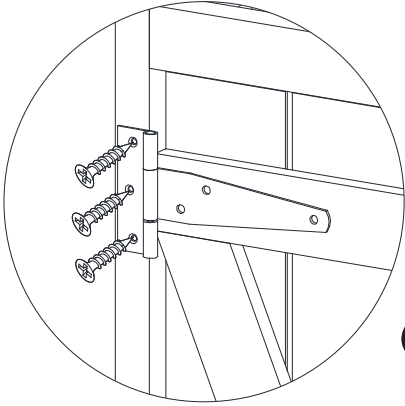

-  ① x 1
-  ② x 1
-  E x 12
- M3.5 x 18

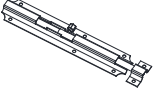

-  H x 2
-  I x 2
-  F x 24
- M3.0 x 16

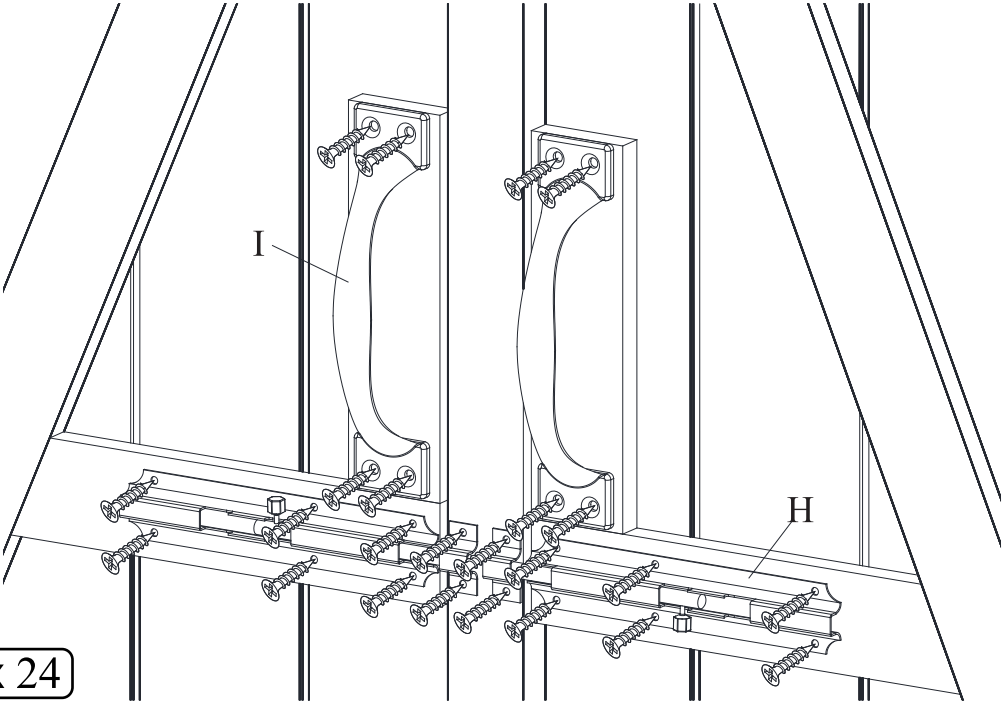

F x 24

13 x 1



C x 4



M3.5 x 30

G x 4



Φ6 x 20

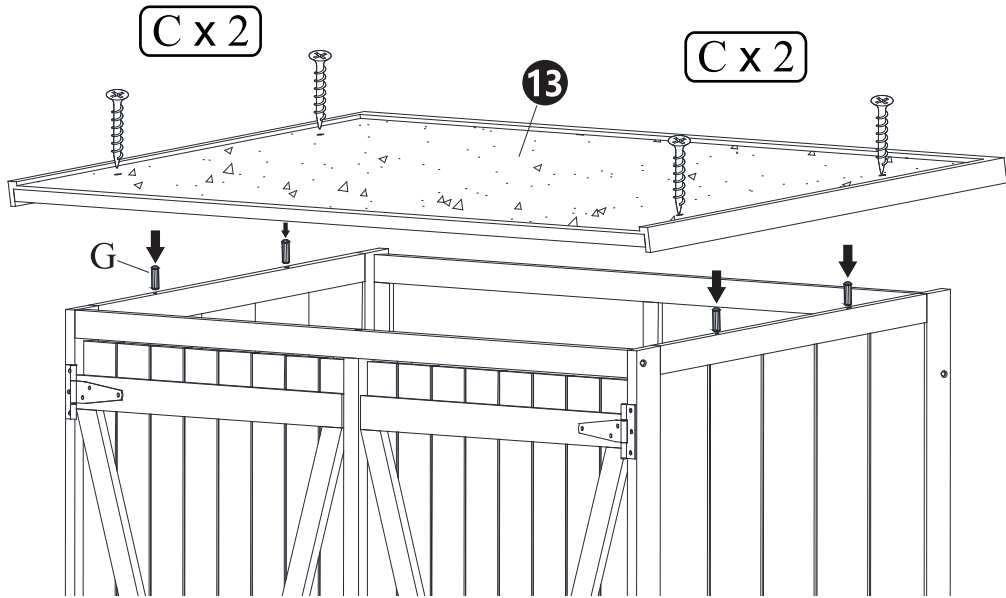

10 x 1

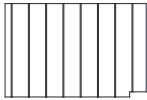

11 x 1



12 x 2

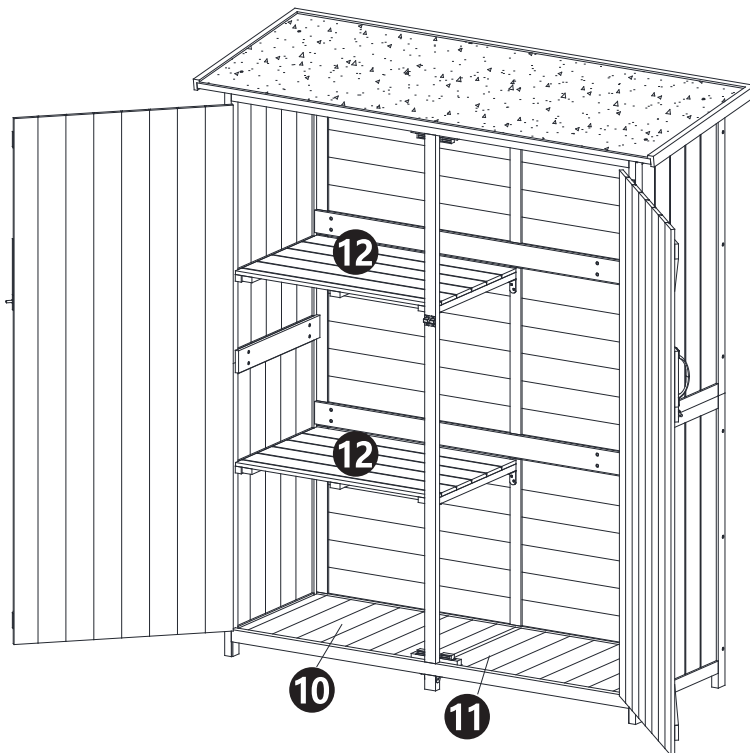
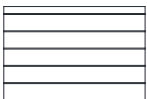

**US**

Imported by Aosom LLC  
 27150 SW Kinsman Rd Wilsonville, OR 97070 USA  
 MADE IN CHINA

**CA**

Imported by Aosom Canada Inc.  
 1251 Tapscott Road, Unit 101, Scarborough, Ontario Canada M1X 1S9  
 MADE IN CHINA

Importé par Aosom Canada Inc.  
 1251 Rue Tapscott, Unité 101, Scarborough, Ontario Canada M1X 1S9  
 FABRIQUÉ EN CHINE

**UK**

IMPORTER ADDRESS:  
 MH STAR UK LTD  
 Unit 27, Perivale Park,  
 Horsenden lane South  
 Perivale, UB6 7RH  
 MADE IN CHINA

**FR**

ADRESSE D'IMPORTATION:  
 MH FRANCE  
 2 Rue Maurice Hartmann  
 92130 Issy Les Moulineaux  
 France  
 FABRIQUÉ EN CHINE



**FR**

**Pensez à donner ou recycler.**

 Association
 ou
 Magasin
 ou
 Déchèterie

<https://quefairedemesdechets.fr>

**ES**

IMPORTADOR:  
 SPANISH AOSOM, S.L.  
 C/ROC GROS,Nº15.08550, ELS HOSTALETS DE BALENYÀ, SPAIN.  
 B66295775  
 WWW.AOSOM.ES  
 ATENCIONCLIENTE@AOSOM.ES  
 TEL: 931294512  
 HECHO EN CHINA

**DE**

ADRESSE DES IMPORTEURE:  
 MH Handel GmbH  
 Wendenstraße 309  
 D-20537 Hamburg  
 Germany  
 IN CHINA HERGESTELLT

**IT**

IMPORTATO DA:  
 AOSOM Italy srl  
 Centro Direzionale Milanofiori  
 Strada 1 Palazzo F1  
 20057 Assago (MI)  
 P.I.: 08567220960  
 FATTO IN CINA