

PawHut

IN221000352V01_GL

D51-081_D51-081V00

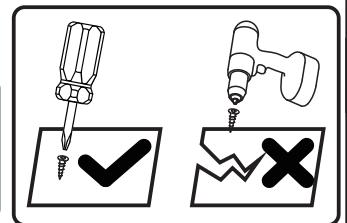
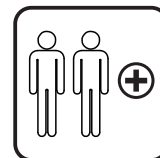
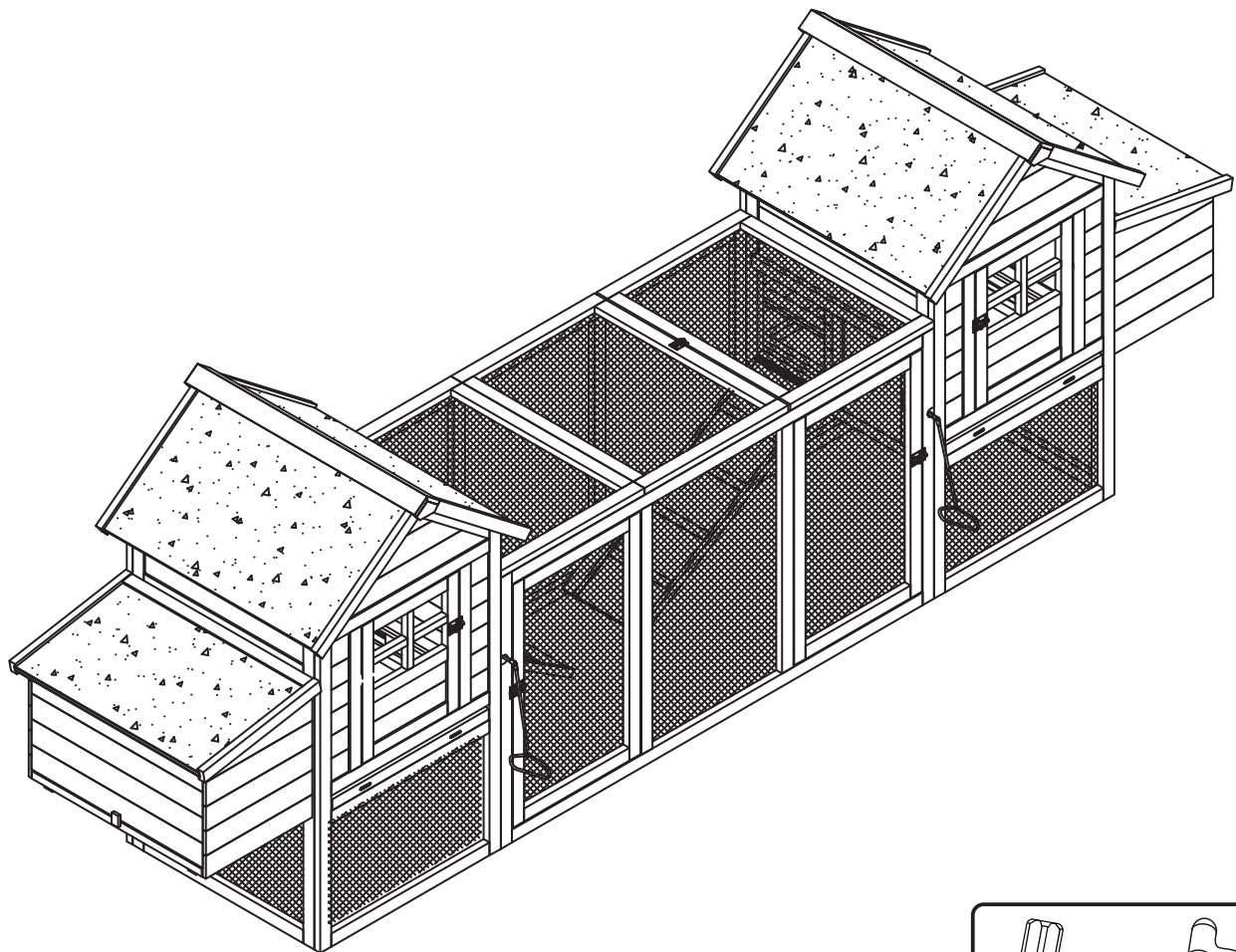

Tools Recommended

EN_IMPORTANT, RETAIN FOR FUTURE REFERENCE: READ CAREFULLY.

FR_IMPORTANT: A LIRE ATTENTIVEMENT ET À CONSERVER POUR CONSULTATION ULTÉRIEURE.

ES_IMPORTANTE, LEA Y GUARDE PARA FUTURAS REFERENCIAS.

PT_IMPORTANTE, RETER PARA REFERÊNCIA FUTURA: LEIA ATENTAMENTE.

DE_WICHTIG! SORGFÄLTIG LESEN UND FÜR SPÄTER NACHSCHLAGEN AUFBEWAHREN.

IT_IMPORTANTE! CONSERVARE IL PRESENTE MANUALE PER FUTURO RIFERIMENTO E LEGGERLO ATTENTAMENTE.

**BOX
1-2**



① 1PC



② 1PC

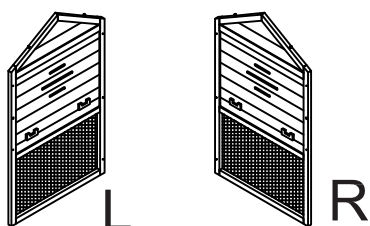

③ 1PC

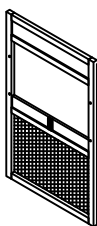

④ 2PCS

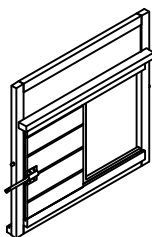



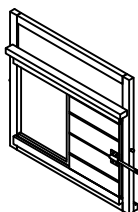

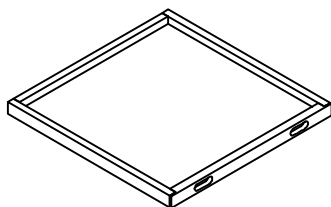

⑤ 1PC



⑥ 1PC

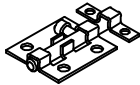
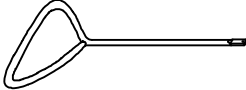
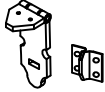

⑬ 2PCS

A	 3.5*60	12PCS+1
B	 3.5*40	38PCS+2
C	 3.5*35	16PCS+1
D	 3*25	8PCS+1
E	 3*16	26PCS+2
F	 3*10	8PCS+1
G	 $\phi 6*45$	8PCS+1
H		1PC
I		2PCS
J		2PCS

**BOX
2-2**

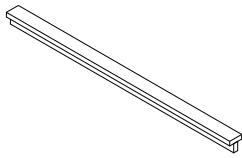

⑦ 4PCS

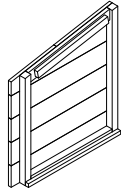

⑧ 2PCS

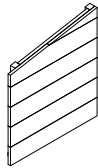

⑨ 2PCS

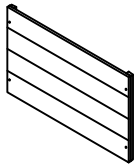

⑩ 2PCS

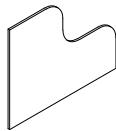

⑪ 2PCS

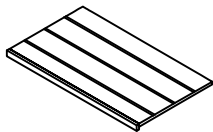

⑫ 2PCS

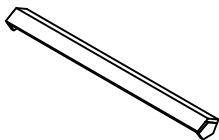

⑭ 2PCS

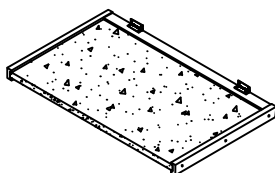

⑮ 2PCS

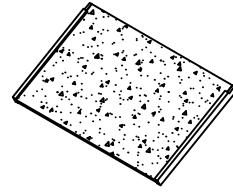

⑯ 4PCS

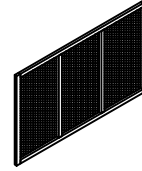

⑰ 1PC

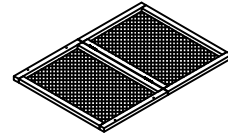

⑱ 1PC

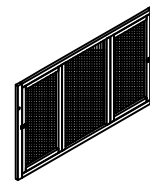

⑲ 1PC

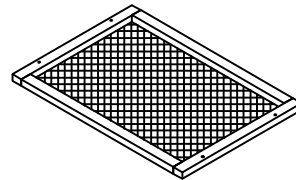

⑳ 1PC

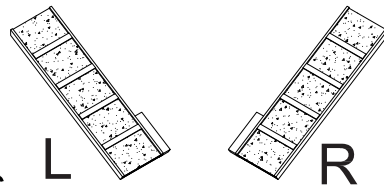

㉑ 1PC

EN

Dear customer,

Thank you for purchasing this product. So that your appliance serves you well, please read all the instructions in this user's manual. If you have any questions, please contact our customer care center, Our contact details are below:

FR

Cher client,

Nous vous remercions d'avoir acheté ce produit. Afin que vous puissiez profiter pleinement de votre appareil, veuillez lire toutes les instructions de ce manuel d'utilisation. Si vous avez la moindre question, veuillez contacter notre centre d'assistance à la clientèle, Nos coordonnées sont les suivantes:

DE

Sehr geehrter Kunde,

Vielen Dank, dass Sie dieses Produkt erworben haben. Damit Ihr Gerät Ihnen gute Dienste leistet, lesen Sie bitte alle Hinweise in diesem Benutzerhandbuch. Wenn Sie Fragen haben, wenden Sie sich bitte an unser Kundendienstzentrum, Unsere Kontaktdaten stehen unten:

ES

Queridos clientes,

Gracias por comprar este producto. Para que su electrodoméstico le sirva mejor, lea todas las instrucciones de este manual del usuario. Si tiene alguna pregunta, comuníquese con nuestro Centro de Atención al Cliente, Nuestros datos de contacto son los siguientes:

PT



Caros clientes,

Obrigado por adquirir este produto. Para que o seu aparelho o sirva melhor, leia todas as instruções deste manual do utilizador. Se tiver alguma dúvida, por favor contacte o nosso Centro de Atendimento ao Cliente, Os nossos dados de contacto são os seguintes:

IT

Caro Cliente,

Grazie per aver acquistato questo prodotto. Per servirti meglio con questo apparecchio ti prego di leggere tutte le istruzioni in presente manuale utente. In caso di dubbio, si prega di contattare il nostro centro assistenza clienti, I nostri dettagli di contatto sono di seguito:

Country	 Phone	 Email
US	001-877-644-9366	customerservice@aosom.com
CA	416-792-6088	customerservice@aosom.ca
UK	0044-800-240-4004	enquiries@mhstar.co.uk
DE	0049-0(40)-88307530	service@aosom.de
FR	0033-1-84166106	aosom@mhfrance.fr
ES	0034-931294512	atencioncliente@aosom.es
PT	0034-931294512	info@aosom.pt
IT	0039-0249471447	clienti@aosom.it



①x01

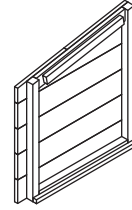

⑧x02



②x01

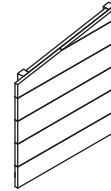

⑨x02

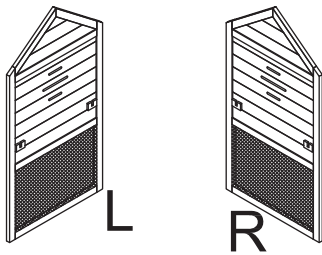

③x01

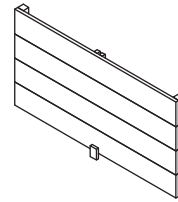

⑩x02

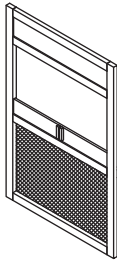

④x02

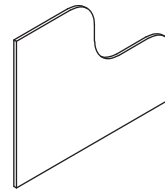

⑪x02

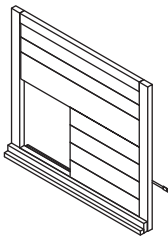

⑤x01

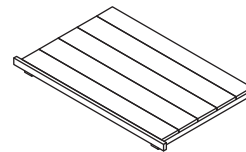

⑫x02

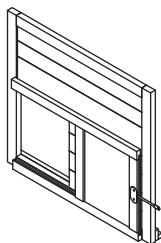

⑥x01

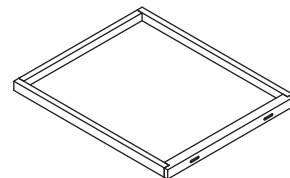

⑬x02

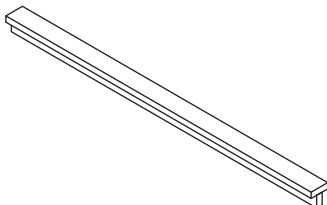

⑦x04

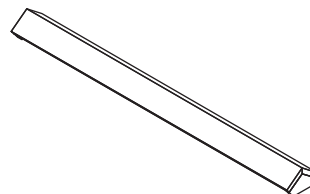

⑭x02

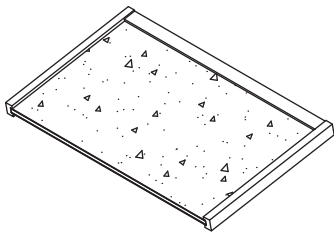

15 x02

A

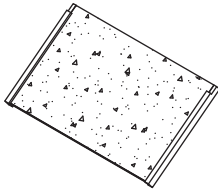

16 x04

B

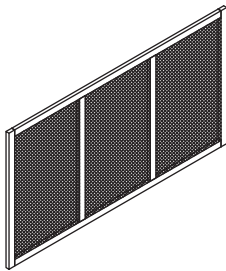

17 x01

C

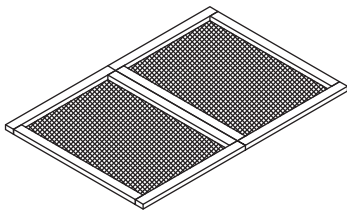

18 x01

D

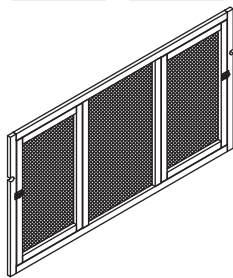

19 x01

E

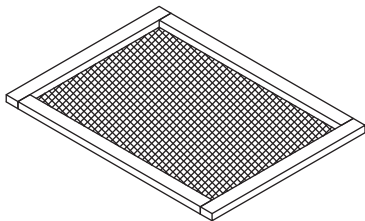

20 x01

F

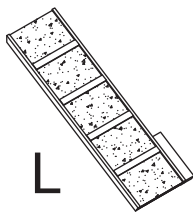

L

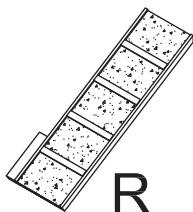

R

21 x01

G

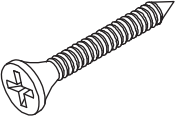
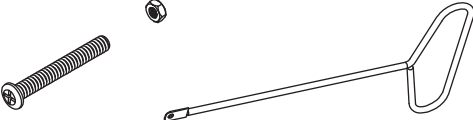
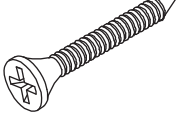
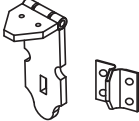
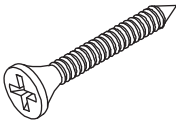
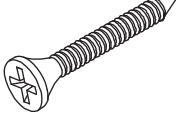
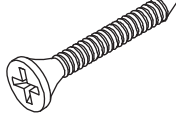
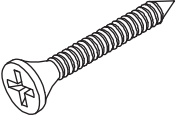
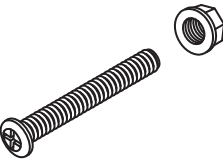
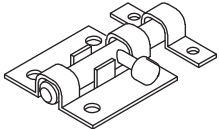
M3.5*60		A x12+1(spare)		I x02 
M3.5*40		B x38+2(spare)		J x02 
M3.5*35		C x16+1(spare)		
M3*25		D x08+1(spare)		
M3*16		E x26+2(spare)		
M3*10		F x08+1(spare)		
M6*45		G x08+1(spare)		
		H x01		

EN_ Do not confuse similar screws.
FR_ Ne pas confondre des vis similaires.
ES_ No confunda tornillos similares.
PT_ Não confundir parafusos semelhantes.
DE_ Verwechseln Sie ähnliche Schrauben nicht.
IT_ Non confondere le viti simili.

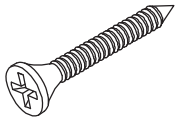

B x05

M3.5*40

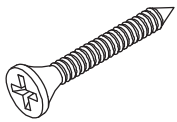
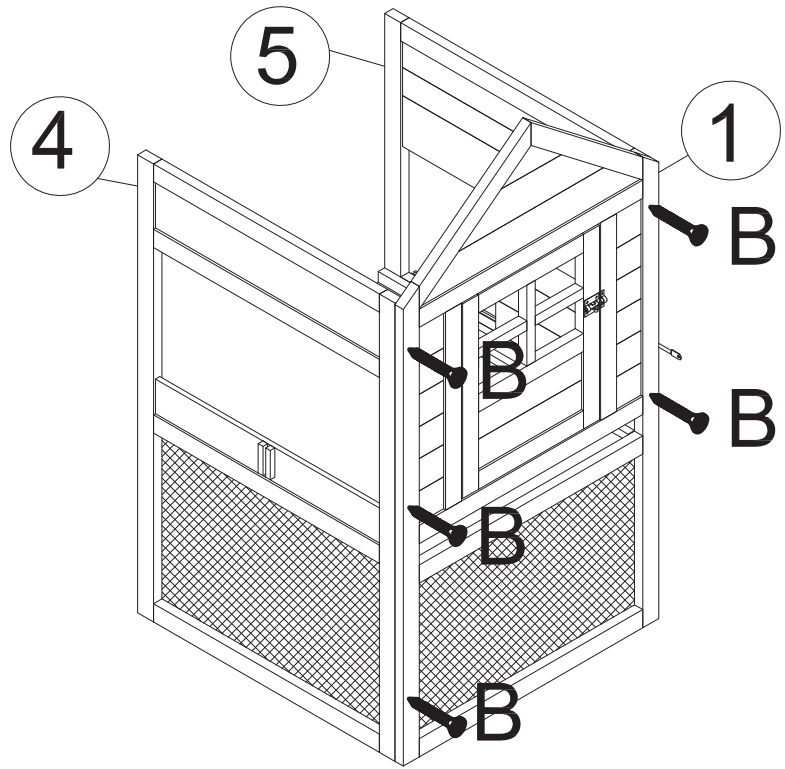

B x05

M3.5*40

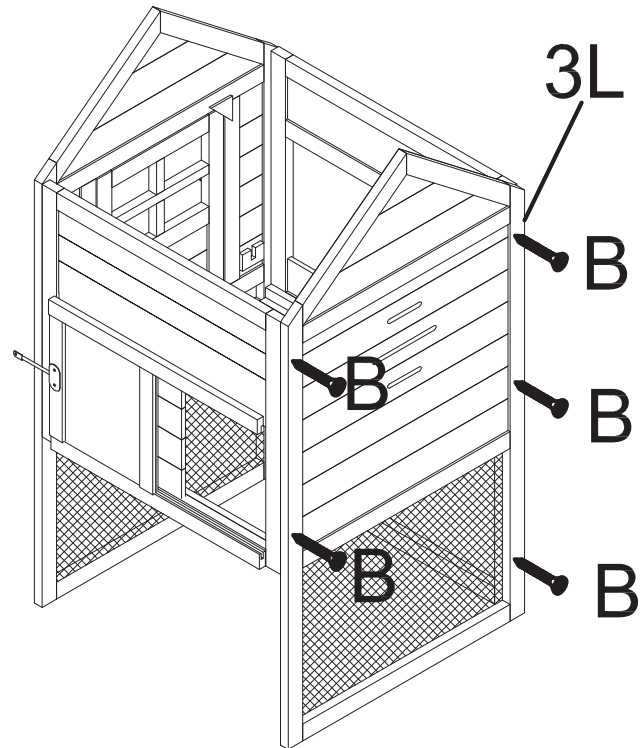

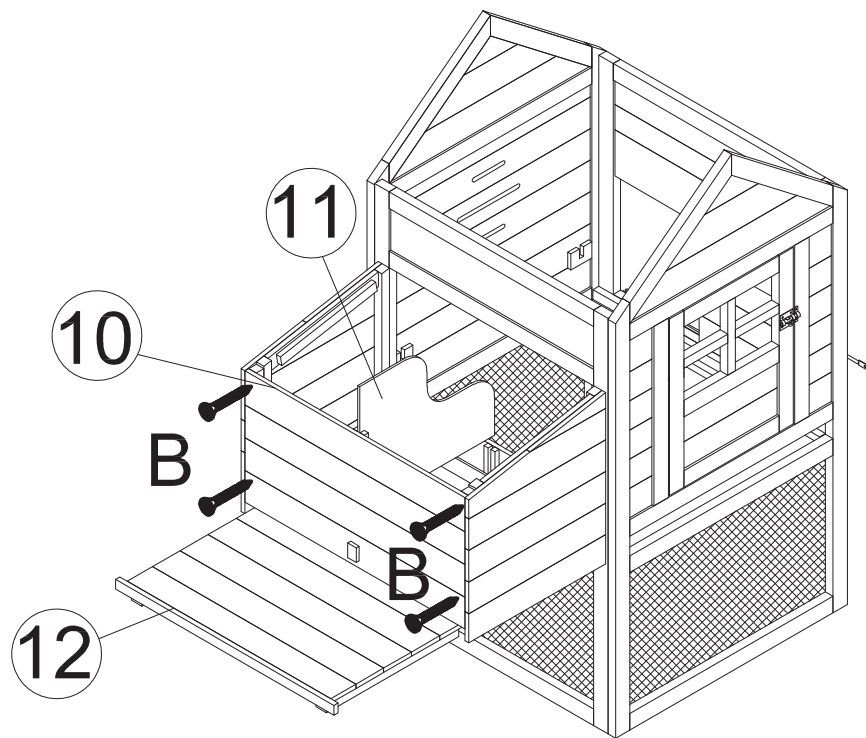
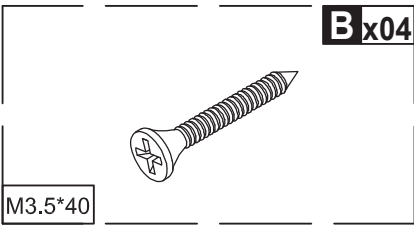
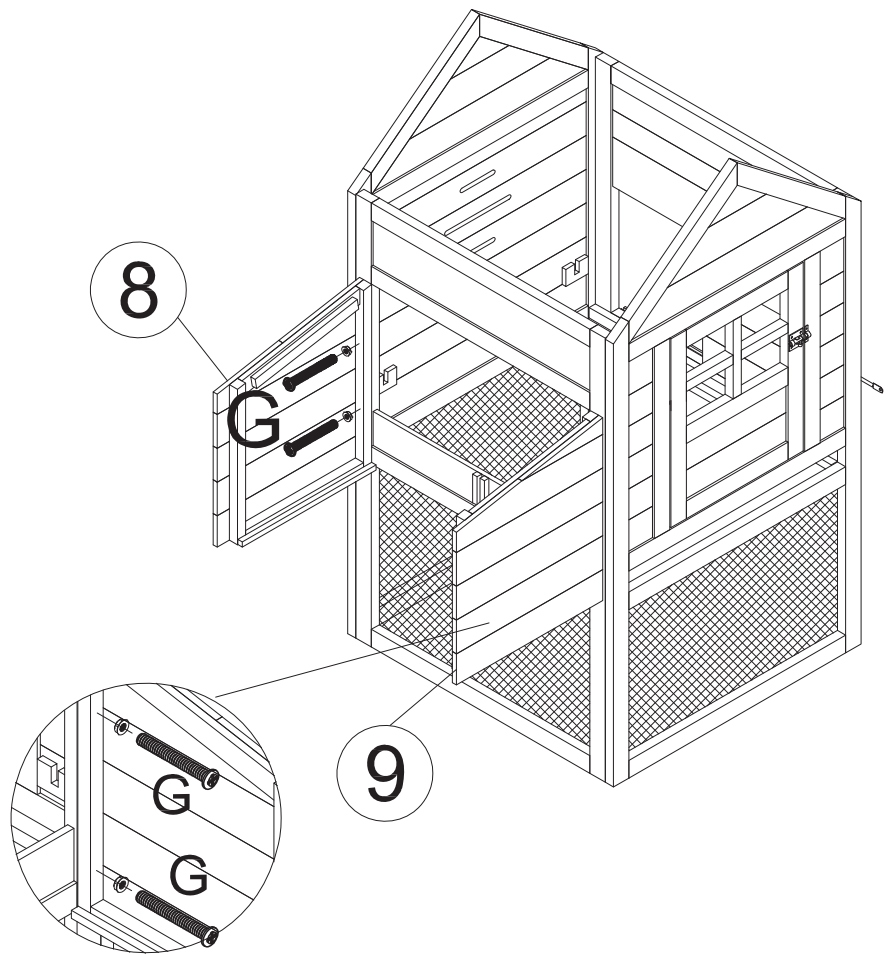
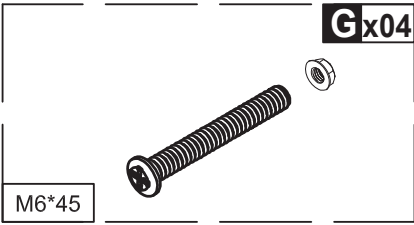

B x05

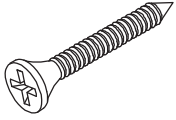

M3.5*40

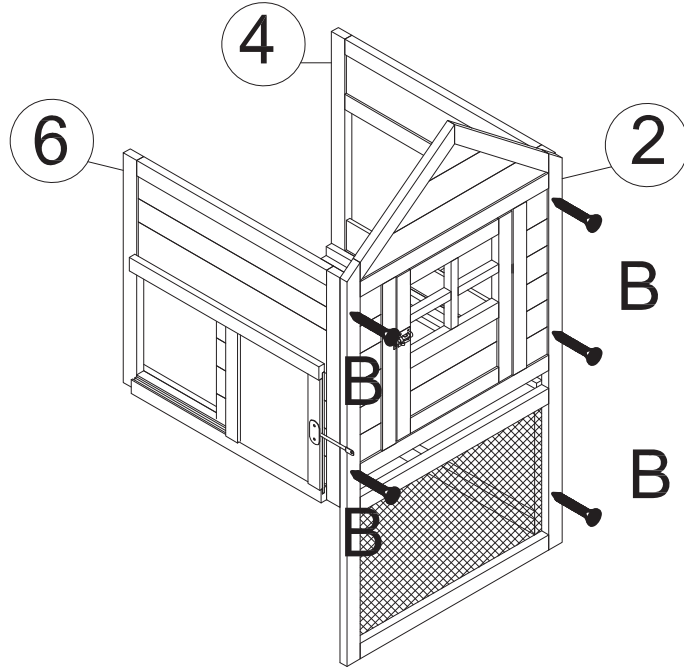

B x05

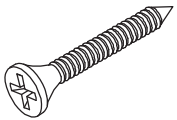

M3.5*40

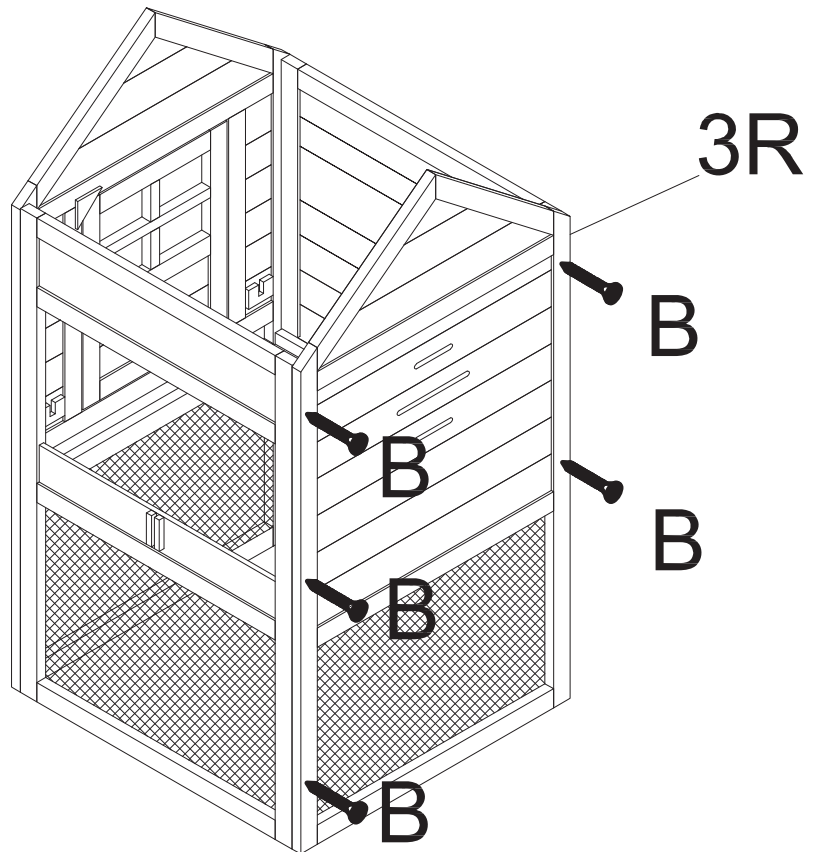

Gx04

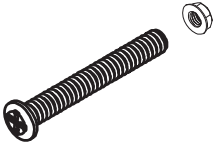

M6*45

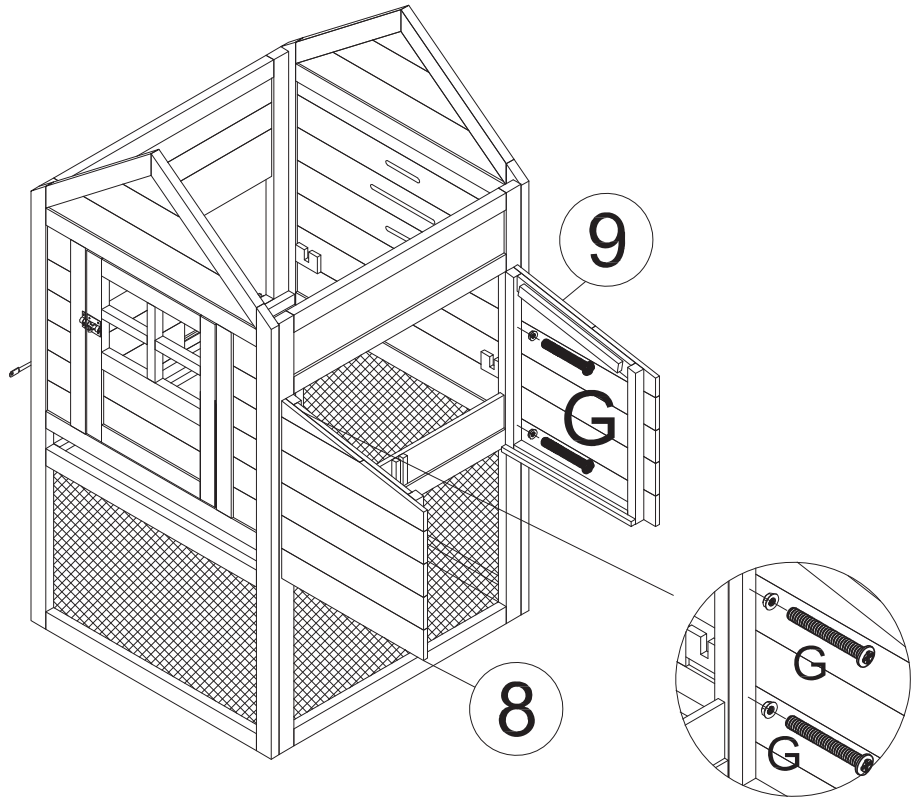

Bx04

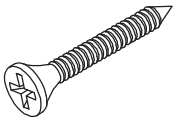

M3.5*40

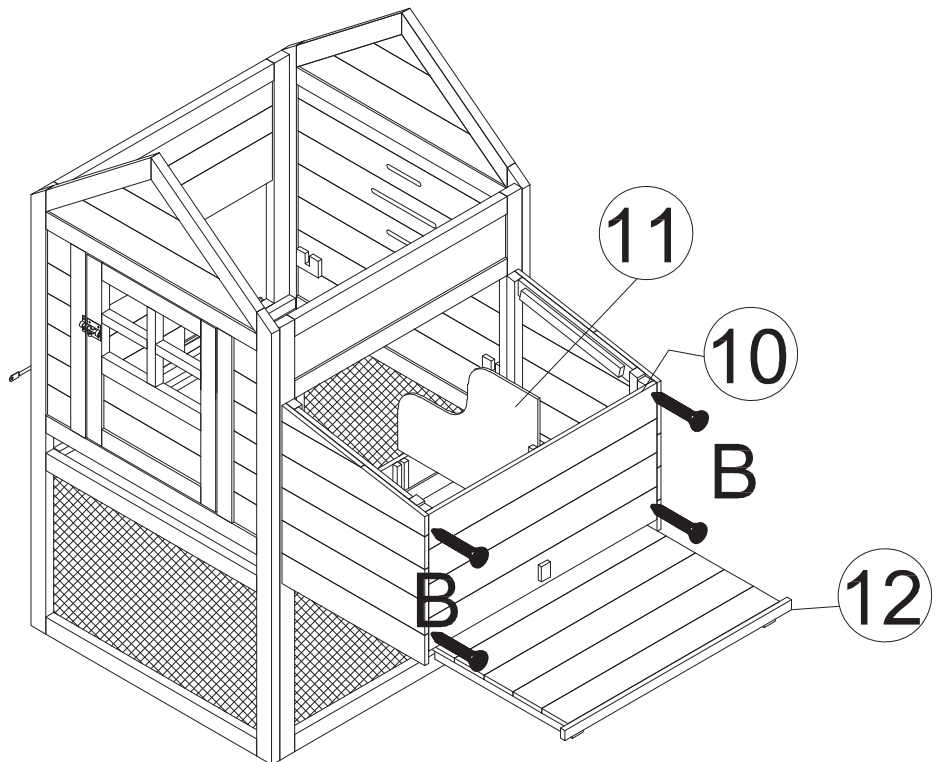

Ex04

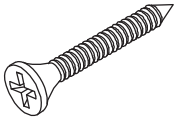

M3*16

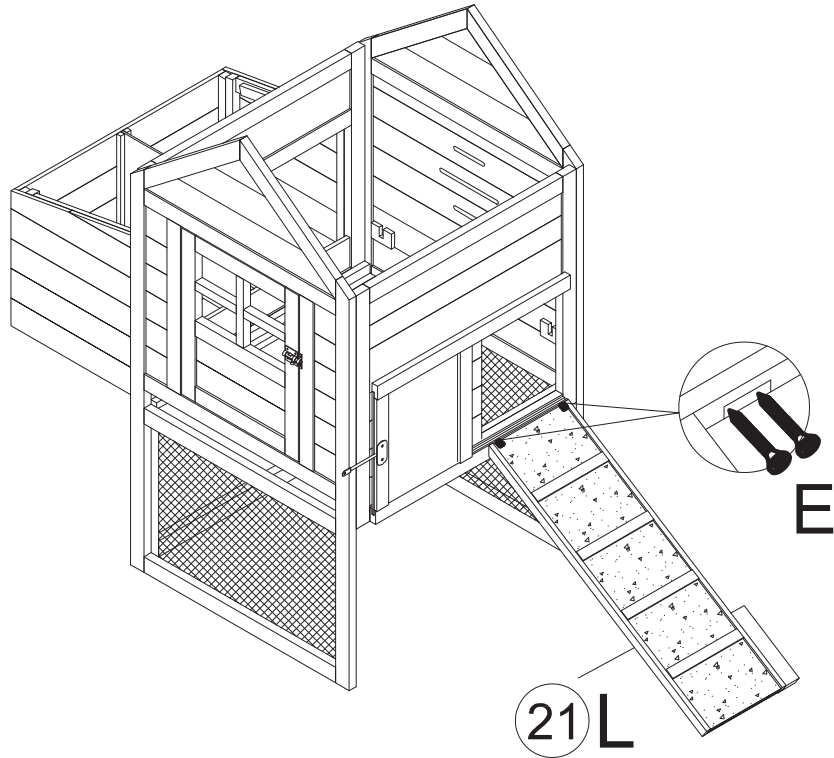

Ax06

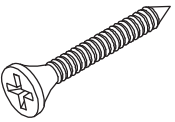

M3.5*60

Bx01

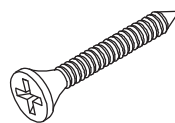

M3.5*40

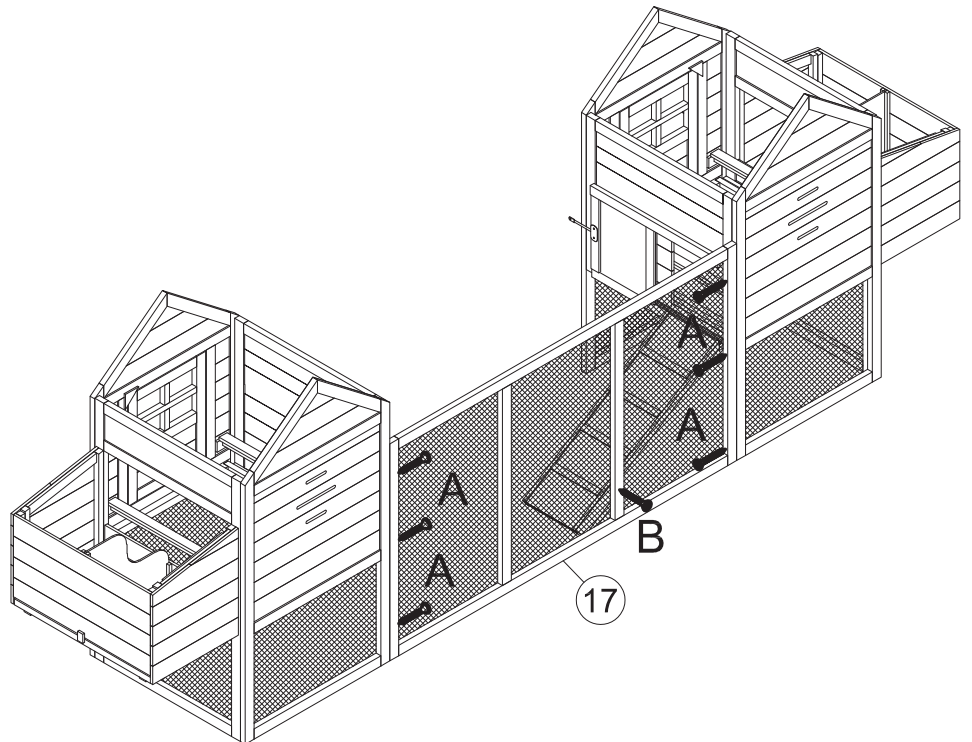

Bx01

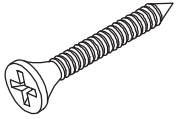

M3.5*40

Ex04

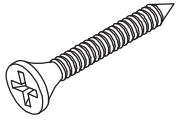

M3*16

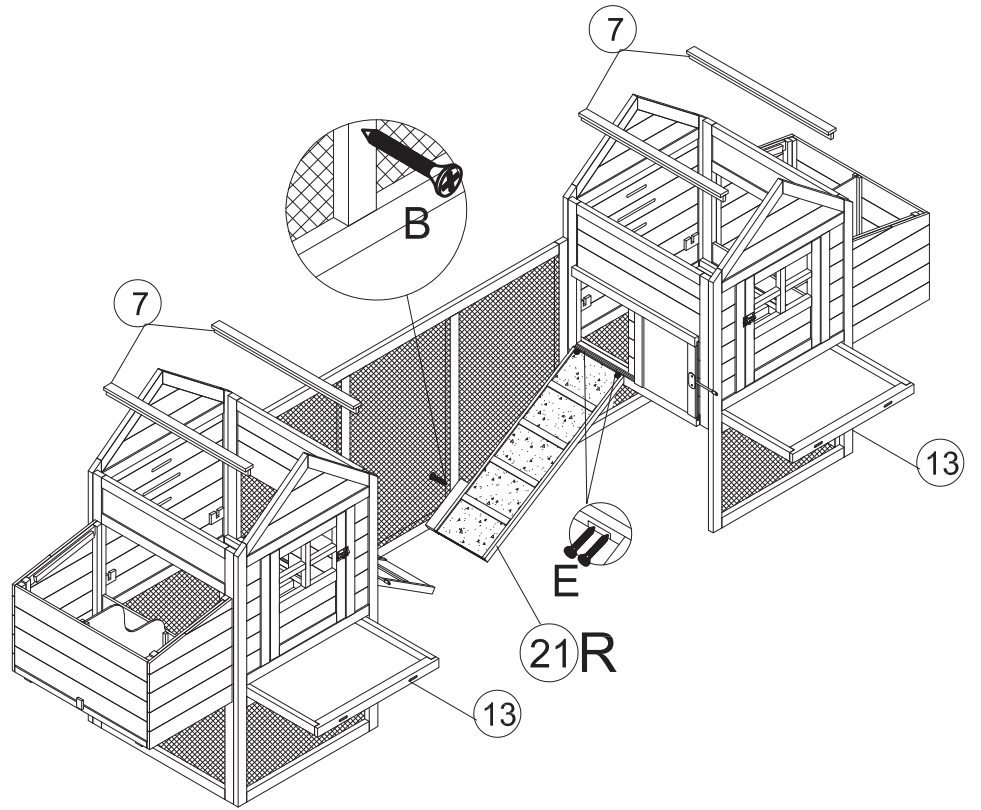

Ax06

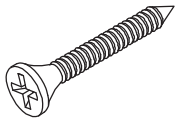

M3.5*60

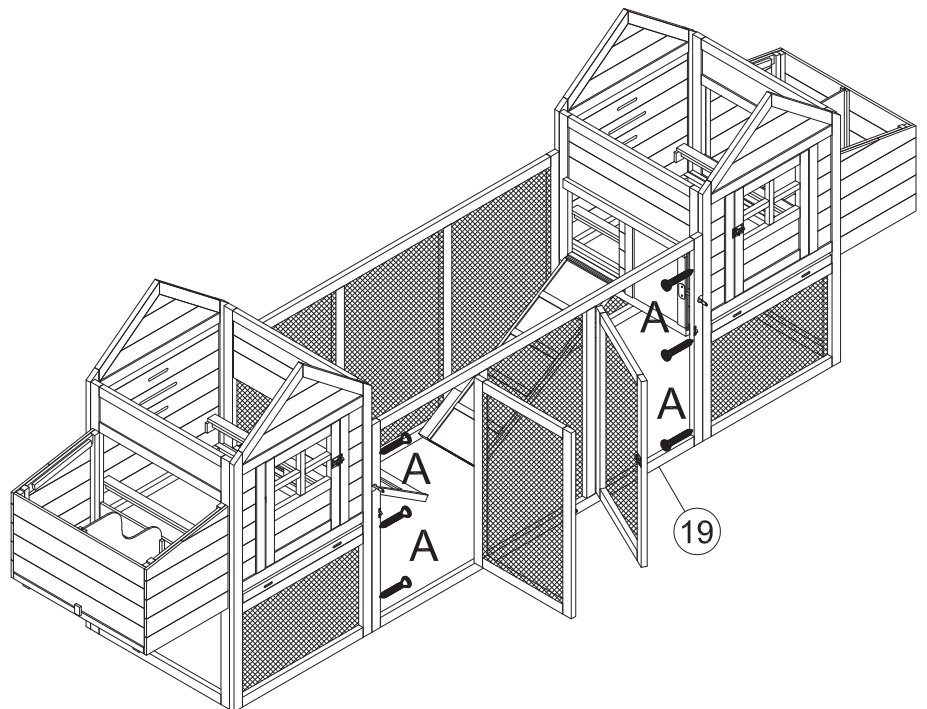

Bx08

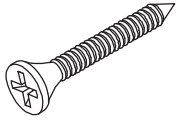

M3.5*40

Ex06

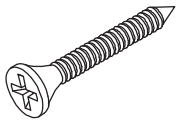

M3*16

Hx01

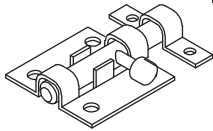

Ix02

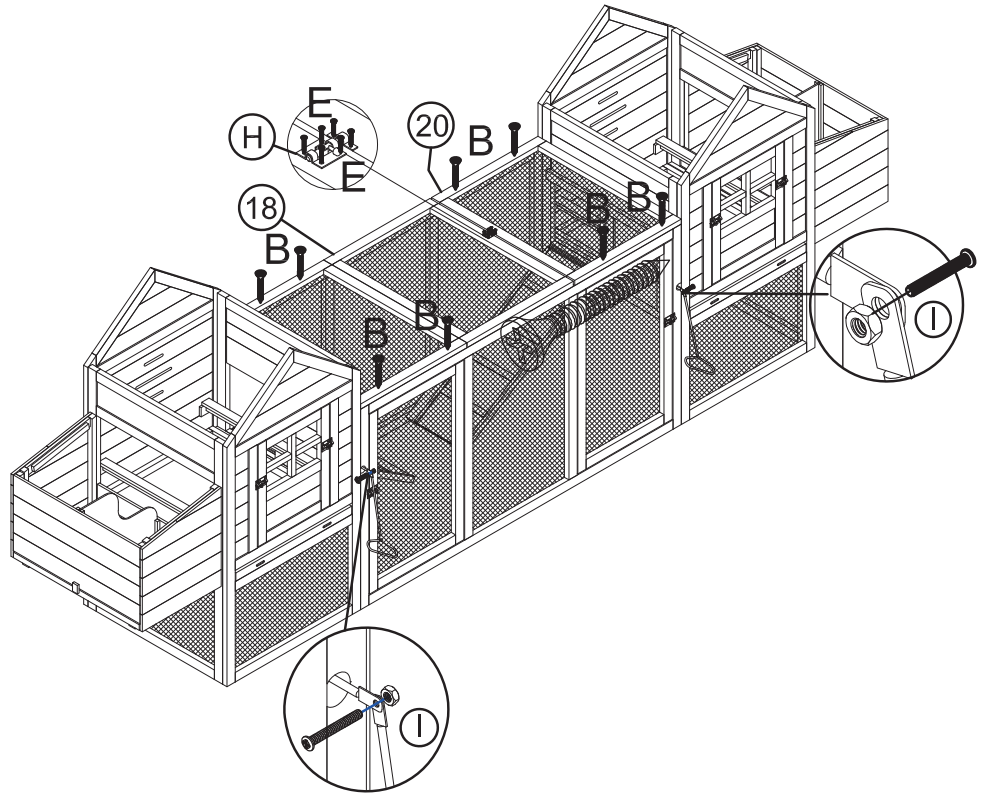

Ex06

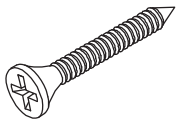

M3*16

Fx04

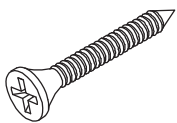

M3*10

Jx01

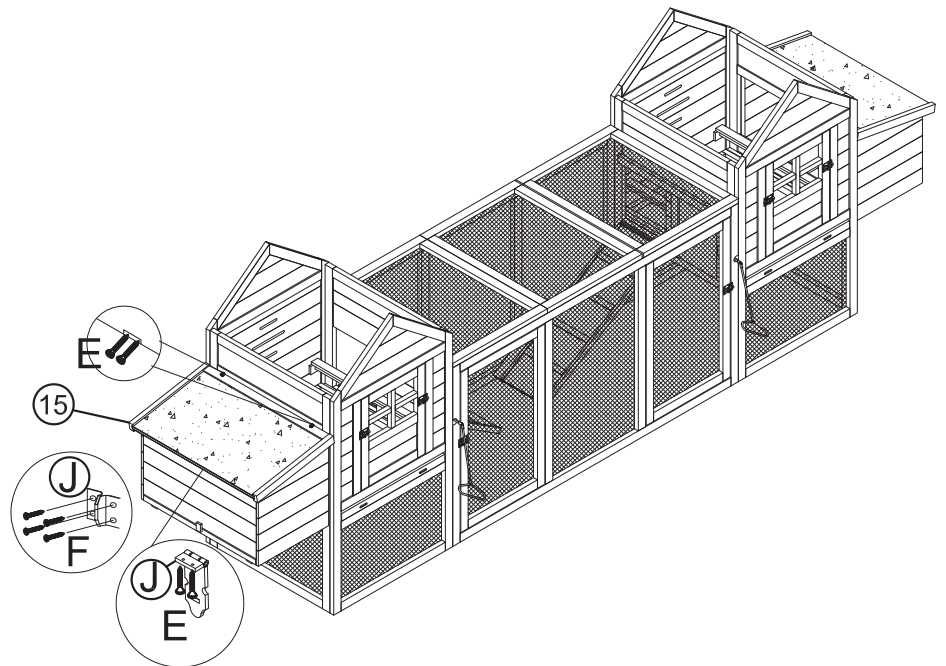
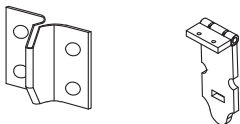

E x06

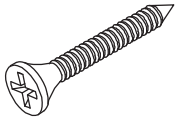

M3*16

F x04

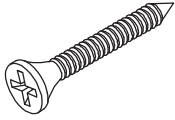

M3*10

J x01

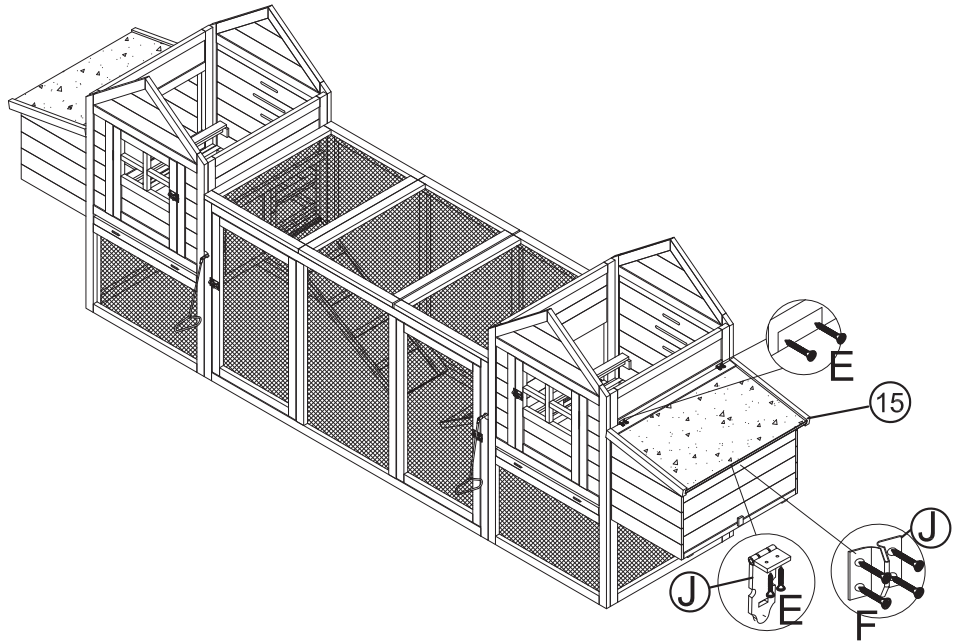
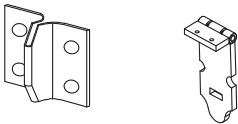

C x16

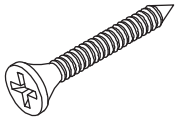

M3.5*35

D x08

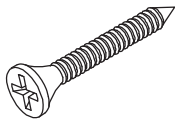

M3*25

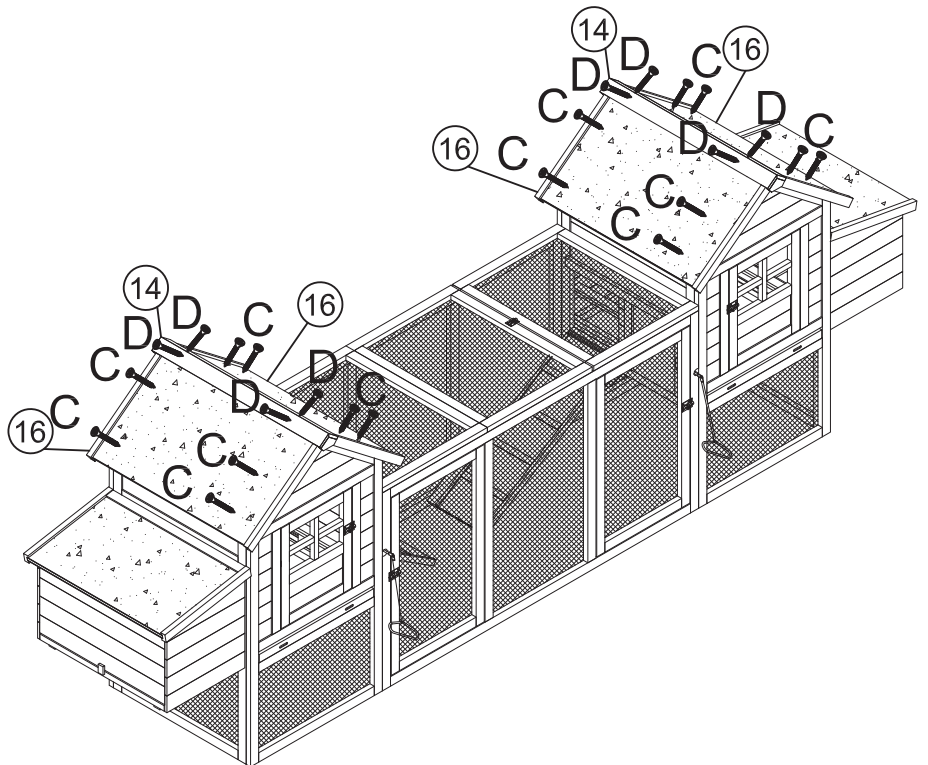

US

Imported by Aosom LLC
27150 SW Kinsman Rd Wilsonville, OR 97070 USA
MADE IN CHINA

CA

Imported by Aosom Canada Inc.
7270 Woodbine Avenue, Unit 307, Markham, Ontario Canada
L3R 4B9
MADE IN CHINA

Importé par Aosom Canada Inc.
7270 Woodbine Avenue, unité 307, Markham, Ontario Canada
L3R 4B9
Fabriqué en Chine

UK

IMPORTER ADDRESS:
MH STAR UK LTD
Unit 27, Perivale Park,
Horsenden lane South
Perivale, UB6 7RH
MADE IN CHINA

FR

ADRESSE D'IMPORTATION:
MH FRANCE
2 Rue Maurice Hartmann
92130 Issy Les Moulineaux
France
FABRIQUÉ EN CHINE



Adresses sur quefairedemesdechets.fr

ES

IMPORTADOR:
SPANISH AOSOM, S.L.
C/ROC GROS, Nº15.08550, ELS HOSTALETS DE BALENYÀ, SPAIN.
B66295775
WWW.AOSOM.ES
ATENCIONCLIENTE@AOSOM.ES
TEL: 931294512
HECHO EN CHINA

PT

SPANISH AOSOM, S.L
C.ROC GROS N.15, 08550. ELS HOSTALETS DE BALENYÀ
TEL: 931294512 (SEG-SEX DAS 7:30H ÀS 16:30H)
INFO@AOSOM.PT
WWW.AOSOM.PT

DE

ADRESSE DES IMPORTEURE:
MH Handel GmbH
Wendenstraße 309
D-20537 Hamburg
Germany
IN CHINA HERGESTELLT

IT

IMPORTATO DA:
AOSOM Italy srl
Centro Direzionale Milanofiori
Strada 1 Palazzo F1
20057 Assago (MI)
P.I.: 08567220960
FATTO IN CINA