

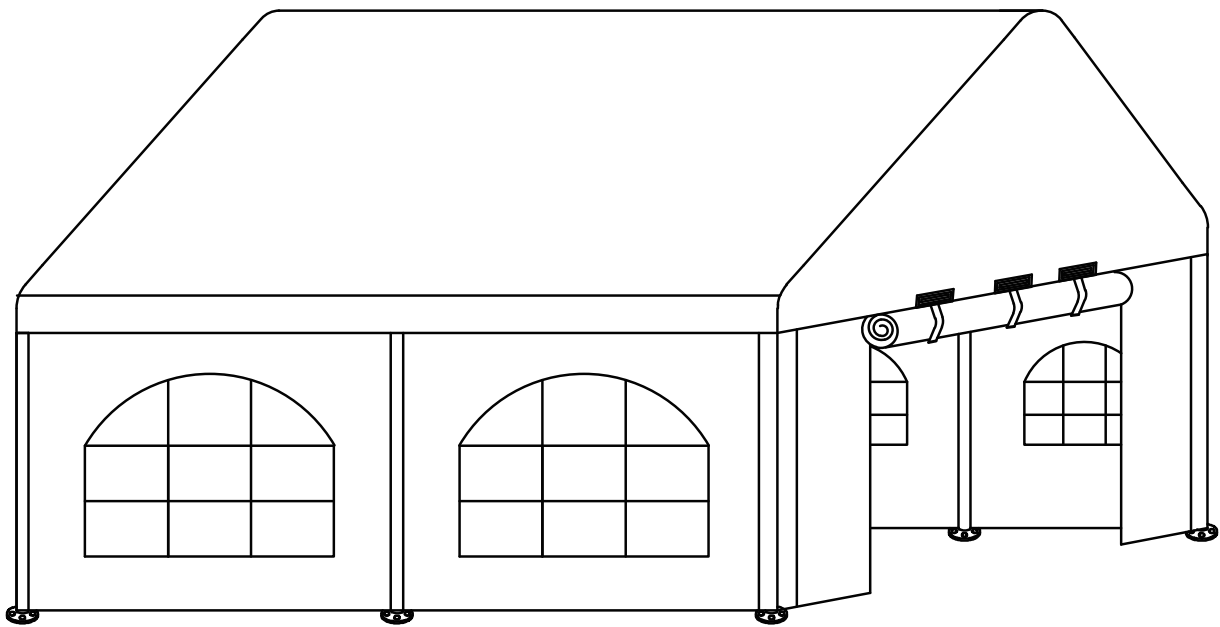

IN221000400V01_GL

84C-370V00_84C-371V00_84C-371V01



EN_IMPORTANT, RETAIN FOR FUTURE REFERENCE: READ CAREFULLY.

FR_IMPORTANT: A LIRE ATTENTIVEMENT ET À CONSERVER POUR CONSULTATION ULTÉRIEURE.

ES_IMPORTANTE, LEA Y GUARDE PARA FUTURAS REFERENCIAS.

PT_IMPORTANTE, RETER PARA REFERÊNCIA FUTURA: LEIA ATENTAMENTE.

DE_WICHTIG! SORGFÄLTIG LESEN UND FÜR SPÄTER NACHSCHLAGEN AUFBEWAHREN.

IT_IMPORTANTE! CONSERVARE IL PRESENTE MANUALE PER FUTURO RIFERIMENTO E LEGGERLO ATTENTAMENTE.

EN

Dear customer,

Thank you for purchasing this product. So that your appliance serves you well, please read all the instructions in this user's manual. If you have any questions, please contact our customer care center, Our contact details are below:

FR

Cher client,

Nous vous remercions d'avoir acheté ce produit. Afin que vous puissiez profiter pleinement de votre appareil, veuillez lire toutes les instructions de ce manuel d'utilisation. Si vous avez la moindre question, veuillez contacter notre centre d'assistance à la clientèle, Nos coordonnées sont les suivantes:

DE

Sehr geehrter Kunde,

Vielen Dank, dass Sie dieses Produkt erworben haben. Damit Ihr Gerät Ihnen gute Dienste leistet, lesen Sie bitte alle Hinweise in diesem Benutzerhandbuch. Wenn Sie Fragen haben, wenden Sie sich bitte an unser Kundendienstzentrum, Unsere Kontaktdaten stehen unten:

ES

Queridos clientes,

Gracias por comprar este producto. Para que su electrodoméstico le sirva mejor, lea todas las instrucciones de este manual del usuario. Si tiene alguna pregunta, comuníquese con nuestro Centro de Atención al Cliente, Nuestros datos de contacto son los siguientes:

PT

Caros clientes,

Obrigado por adquirir este produto. Para que o seu aparelho o sirva melhor, leia todas as instruções deste manual do utilizador. Se tiver alguma dúvida, por favor contacte o nosso Centro de Atendimento ao Cliente, Os nossos dados de contacto são os seguintes:

IT

Caro Cliente,

Grazie per aver acquistato questo prodotto. Per servirti meglio con questo apparecchio ti prego di leggere tutte le istruzioni in presente manuale utente. In caso di dubbio, si prega di contattare il nostro centro assistenza clienti, I nostri dettagli di contatto sono di seguito:

Country	 Phone	 Email
US	001-877-644-9366	customerservice@aosom.com
CA	416-792-6088	customerservice@aosom.ca
UK	0044-800-240-4004	enquiries@mhstar.co.uk
DE	0049-0(40)-88307530	service@aosom.de
FR	0033-1-84166106	aosom@mhfrance.fr
ES&PT	0034-931294512	atencioncliente@aosom.es
IT	0039-0249471447	clienti@aosom.it

EN

1. multi-person assembly is required for this tent.
2. Please take appropriate actions as heavy rain, wind and snow can damage the tent. If necessary please dis-assemble and store for later use.
3. In snowy conditions please do not allow the thickness of the snow to be more than 5cm on the roof, this should be cleared as soon as possible for your safety.

FR

1. multi-personnes minimum requis pour le montage de la tente.
2. Veuillez faire attention lorsque vous utilisez la serre en périodes de fortes pluies, vent ou neige : la serre pourrait être endommagée. Si nécessaire, veuillez démonter la serre afin de pouvoir la réutiliser plus tard.
3. Pour votre sécurité, en période de neige, il est recommandé de ne pas laisser de neige de plus de 5cm sur le toit.

ES

1. Se requieren varias personas para realizar el montaje de esta tienda de campaña.
2. Por favor, tome las medidas oportunas ya que la lluvia, el viento y la nieve pueden dañar la tienda. Si es necesario, desmonte la tienda y guárdela para su uso posterior.
3. En condiciones de nieve, no permita que la nieve tenga más de 5 cm de espesor en el techo, y retírela tan pronto como sea posible para su seguridad.

PT

1. Para a montagem desta tenda de campismo são necessárias multi-pessoas.
2. Tome medidas adequadas, em caso de vento forte, chuva ou neve, pois estas podem danificar a tenda. Caso seja necessário, desmonte e armazene a tenda de campismo para uso posterior.
3. Em caso de neve, não permita que a espessura da neve seja superior a 5cm no teto. Para a sua segurança, retire a neve o mais rápido possível

DE

1. Dieses Zelt muss von mehreren Personen aufgebaut werden.
2. Bitte ergreifen Sie geeignete Maßnahmen, da starker Regen, Wind und Schnee das Zelt beschädigen können. Falls nötig, bauen Sie es bitte ab und bewahren Sie es zur späteren Verwendung auf.
3. Bei Schneefall darf die Schneehöhe auf dem Dach nicht mehr als 5 cm betragen, diese sollte zu Ihrer Sicherheit so schnell wie möglich beseitigt werden.

IT

1. Per assemblare questa tenda sono necessarie multi-persona
2. Si prega di prendere le precauzioni necessaria in quanto pioggia, vento e neve possono danneggiare la tenda. Se necessario si prega di smontarla e conservarla per uso futuro.
3. Qualora nevicasse si prega di non lasciare che lo strato di neve sopra la tenda sia spesso oltre i 5cm, anzi la neve va rimossa al più' presto per la vostra sicurezza.

1 x 6

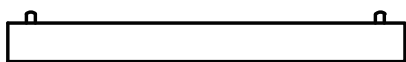

2 x 6

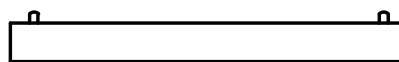

3 x 6

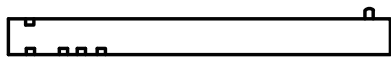

A x 6



B x 3

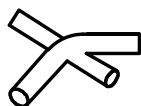

G x 6



H x 12



J x 4



K x 60



M x 6

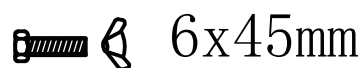

P x 1

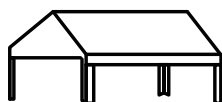

Q x 2

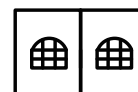

R x 2



S x 4



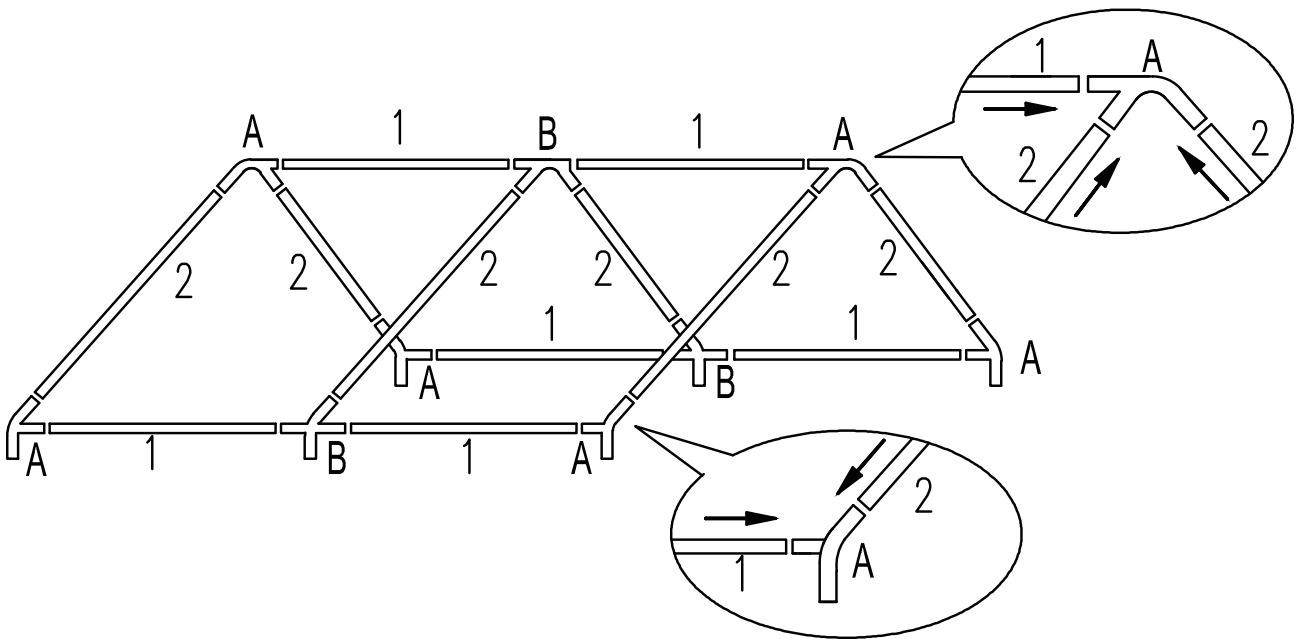
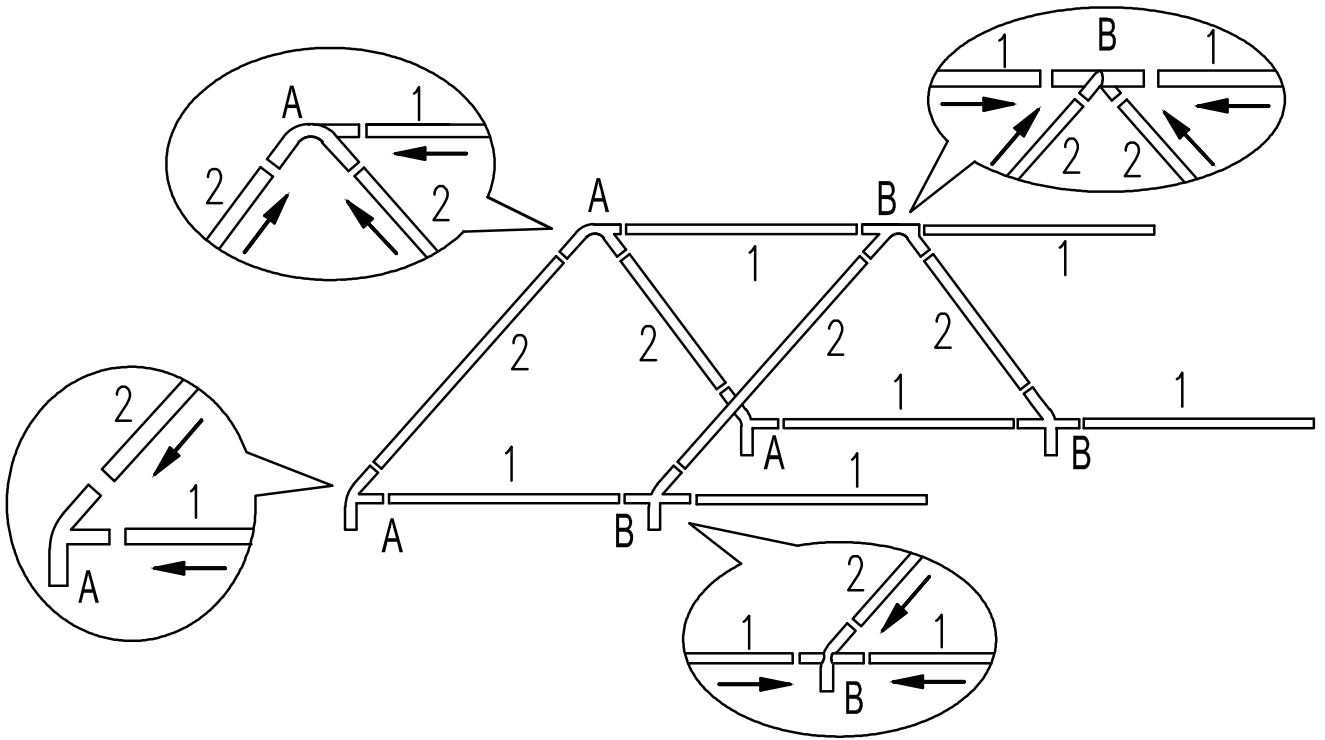

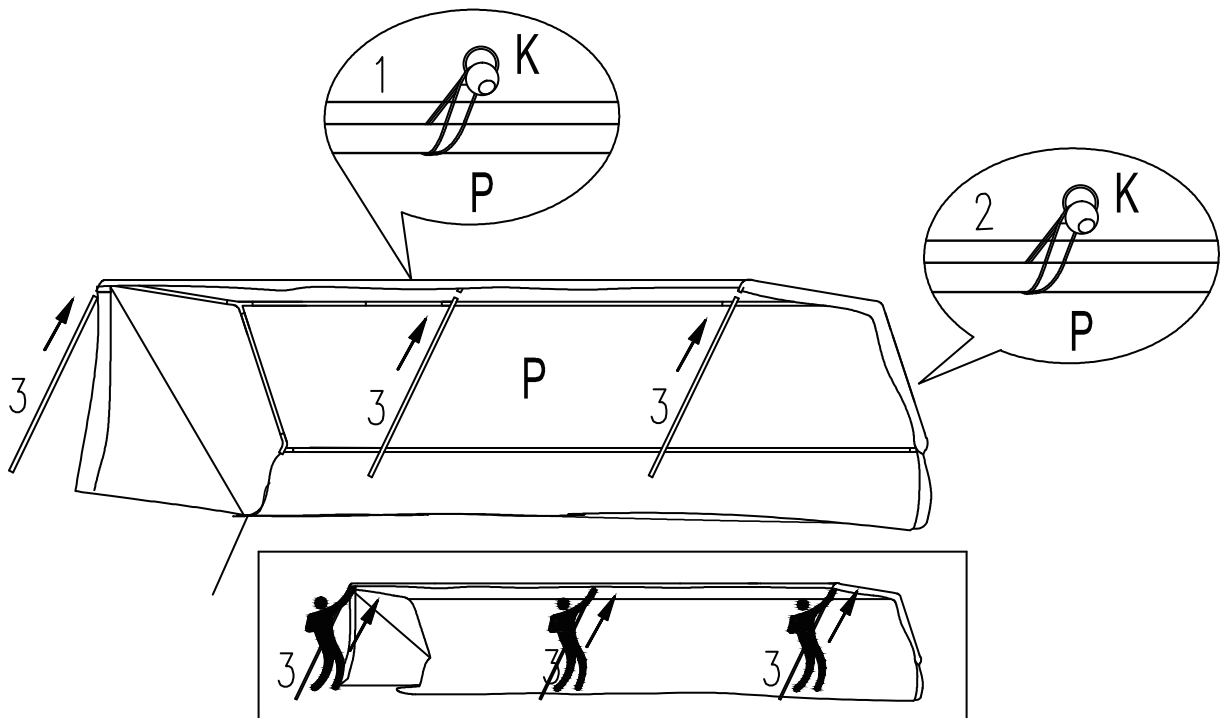
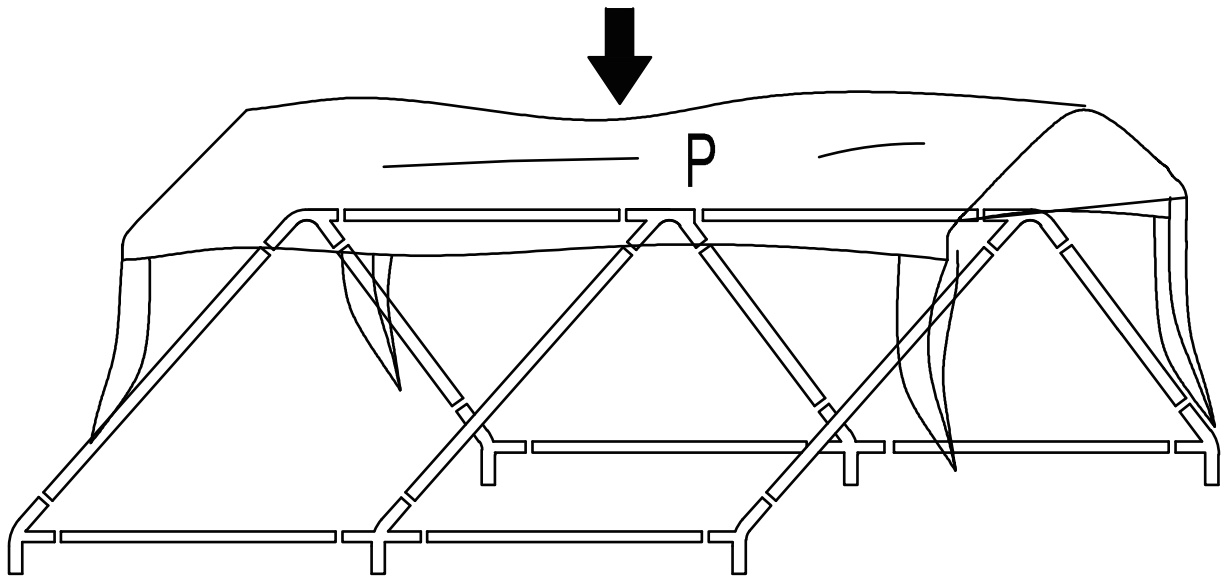

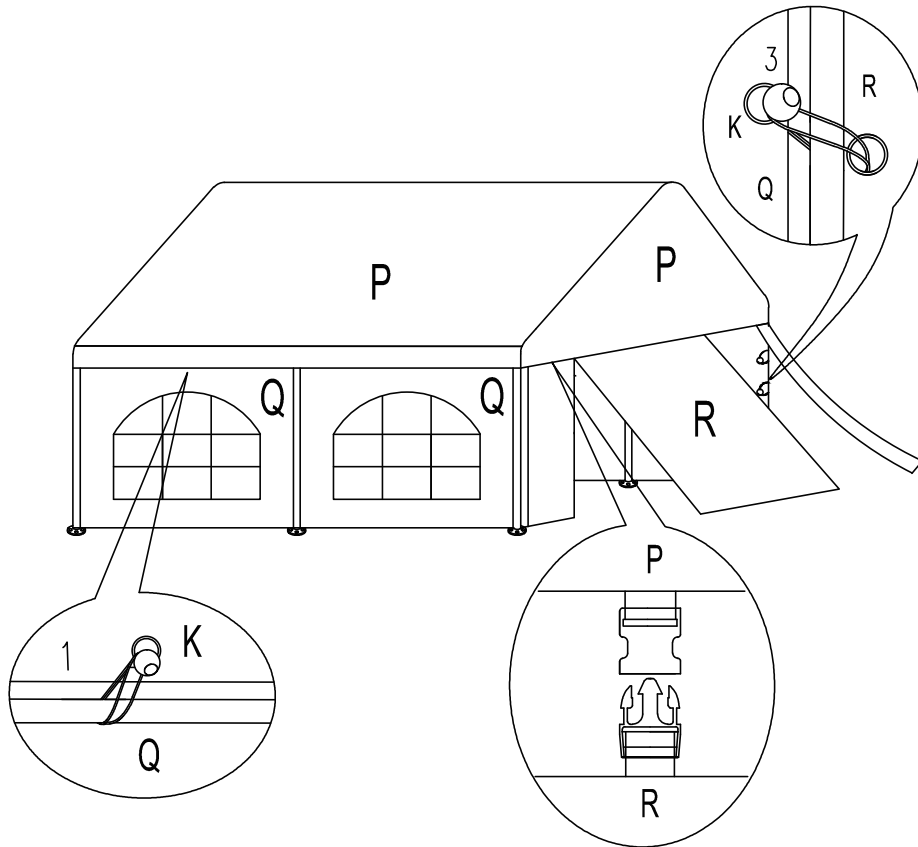
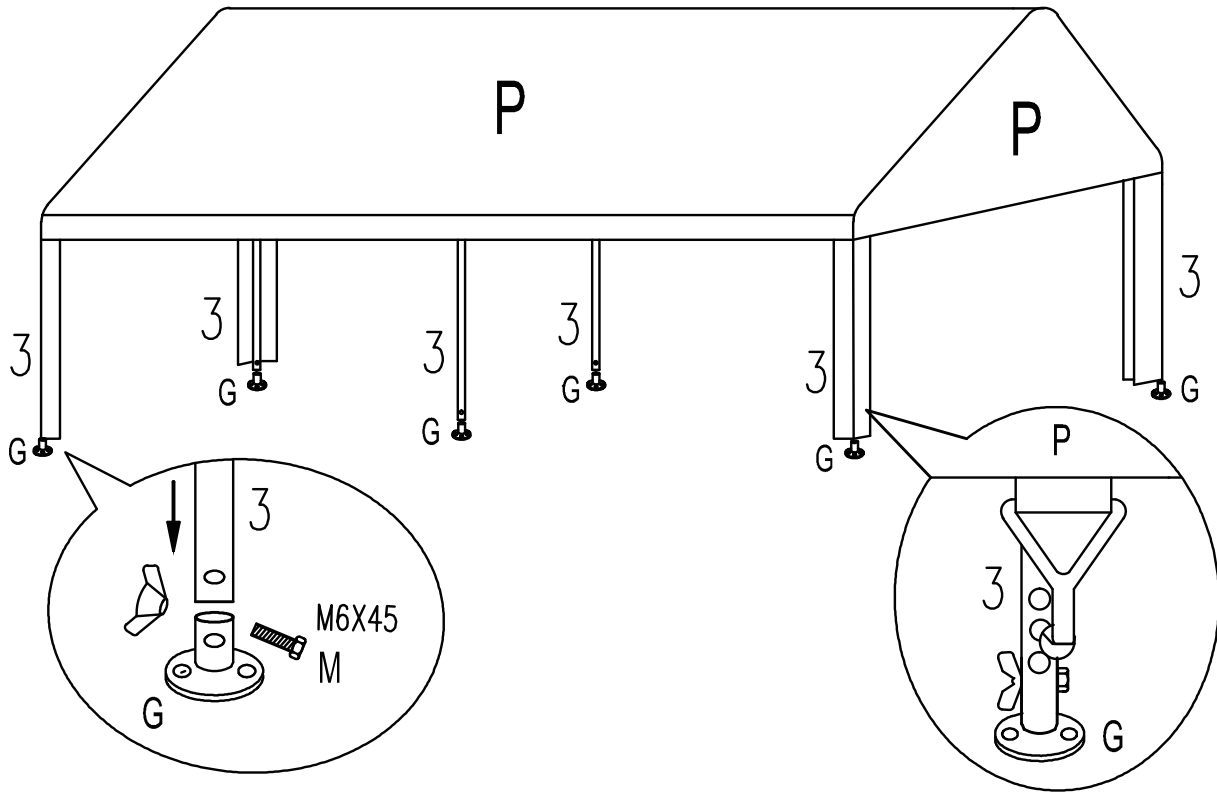

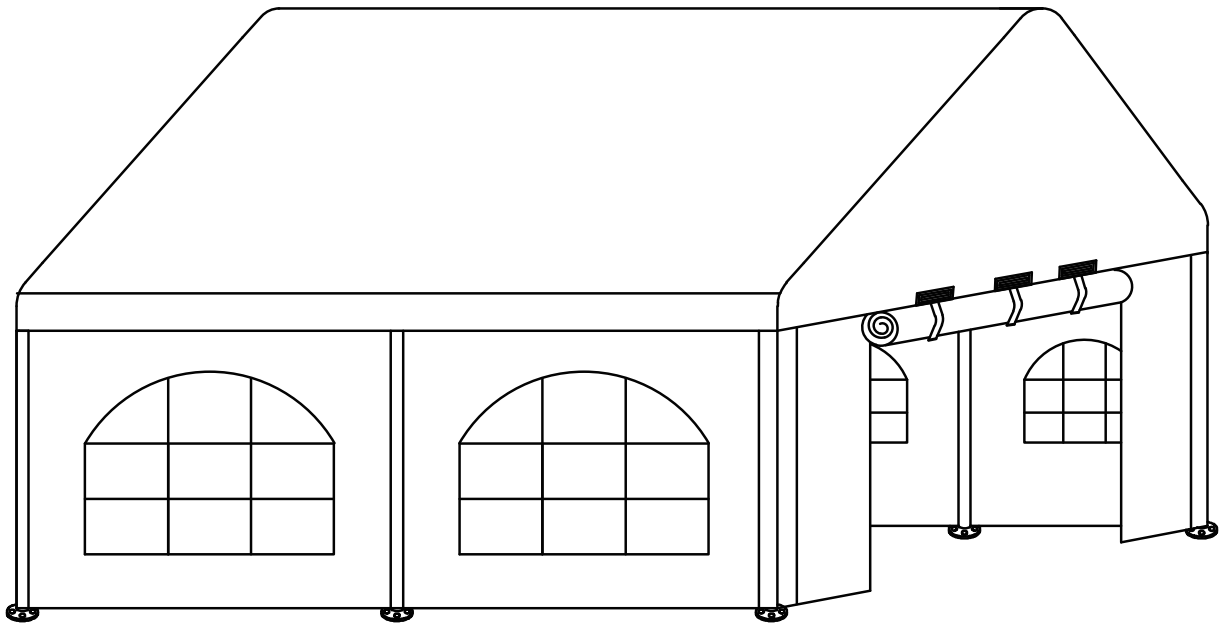
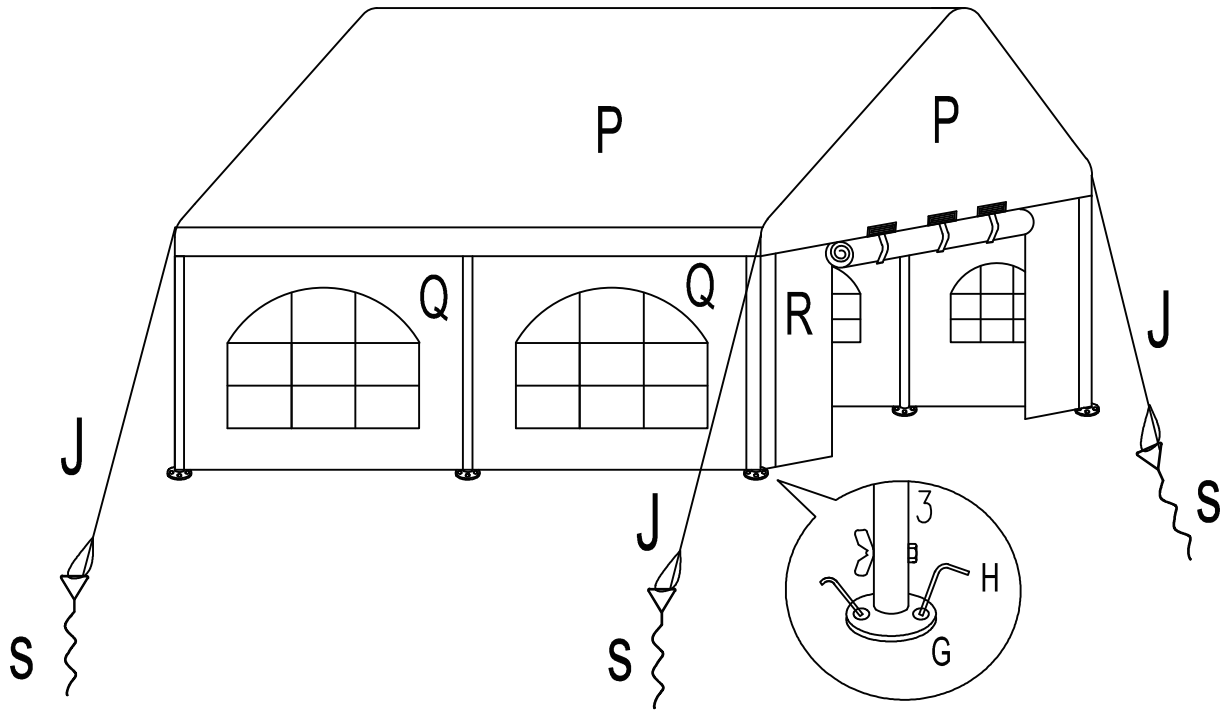

US

Imported by Aosom LLC
27150 SW Kinsman Rd Wilsonville, OR 97070 USA
Manufactured in Ningbo City, Zhejiang Province, China
MADE IN CHINA

CA

Imported by Aosom Canada Inc.
1251 Tapscott Road, Unit 101, Scarborough, Ontario Canada M1X 1S9
Manufactured in Ningbo City, Zhejiang Province, China
MADE IN CHINA

Importé par Aosom Canada Inc.
1251 Rue Tapscott, Unité 101, Scarborough, Ontario Canada M1X 1S9
Fabriqué à Ville de Ningbo, Province du Zhejiang, Chine
FABRIQUÉ EN CHINE

UK

IMPORTER ADDRESS:
MH STAR UK LTD
Unit 27, Perivale Park,
Horsenden lane South
Perivale, UB6 7RH
MADE IN CHINA

FR

ADRESSE D'IMPORTATION:
MH FRANCE
2 Rue Maurice Hartmann
92130 Issy Les Moulineaux
France
FABRIQUÉ EN CHINE

ES

IMPORTADOR:
SPANISH AOSOM, S.L.
C/ROC GROS,Nº15.08550, ELS HOSTALETES DE BALENYÀ, SPAIN.
B66295775
WWW.AOSOM.ES
ATENCIONCLIENTE@AOSOM.ES
TEL: 931294512
HECHO EN CHINA

DE

ADRESSE DES IMPORTEURE:
MH Handel GmbH
Wendenstraße 309
D-20537 Hamburg
Germany
IN CHINA HERGESTELLT

IT

IMPORTATO DA:
AOSOM Italy srl
Centro Direzionale Milanofiori
Strada 1 Palazzo F1
20057 Assago (MI)
P.I.: 08567220960
FATTO IN CINA