

EN: Suitable for children of 3-8 years old; Max weight:50 kg.

FR: Convient aux enfants de 3 à 8 ans; Poids maximum:50 kg.

DE: Geeignet für Kinder im Alter von 3-8 Jahren; Max. Gewicht: 50 kg.

ES: Adecuado para los niños de 3 a 8 años; Peso máximo: 50 kg.

IT: Adatto a bambini di 3-8 anni; Peso massimo: 50 kg.

EN_IMPORTANT, RETAIN FOR FUTURE REFERENCE: READ CAREFULLY.

FR_IMPORTANT: A LIRE ATTENTIVEMENT ET À CONSERVER POUR CONSULTATION ULTÉRIEURE.

ES_IMPORTANTE, LEA Y GUARDE PARA FUTURAS REFERENCIAS.

DE_WICHTIG! SORGFÄLTIG LESEN UND FÜR SPÄTER NACHSCHLAGEN AUFBEWAHREN.

IT_IMPORTANTE! CONSERVARE IL PRESENTE MANUALE PER FUTURO RIFERIMENTO E LEGGERLO ATTENTAMENTE.

EN

WARNING:

1. CHOKING HAZARD—Small parts. Not for children under 3 years.
2. Only allowed for adults to install, keep children away.
3. To be used under the direct supervision of an adult.
4. Place it on a flat and clean floor, Check all the parts are well connected before use.

MAINTENANCE & CARE

- A. Keep all instructions and parts relating to this product for future reference.
- B. Please wipe down with a dry or damp cloth.

FR

AVERTISSEMENT :

1. RISQUE D'ÉTOUFFEMENT - Petites pièces. Déconseillé aux enfants de moins de 3 ans.
2. Installation par des adultes uniquement, tenir les enfants à l'écart.
3. À utiliser sous la surveillance directe d'un adulte.
4. Posez-le sur un sol plat et propre. Vérifiez que toutes les pièces sont bien connectées avant toute utilisation.

ENTRETIEN ET MAINTENANCE

- A. Conservez toutes les instructions et les pièces relatives à ce produit pour pouvoir vous y référer ultérieurement.
- B. Veuillez essuyer avec un chiffon sec ou humide.

DE

WARNUNG:

1. ERSTICKUNGSGEFAHR-Kleine Teile. Nicht für Kinder unter 3 Jahren geeignet.
2. Die Montage darf nur von Erwachsenen vorgenommen werden, halten Sie Kinder fern.
3. Es ist unter der direkten Aufsicht eines Erwachsenen zu verwenden.
4. Stellen Sie es auf einen flachen und sauberen Boden. Prüfen Sie, ob alle Teile vor der Verwendung gut verbunden sind.

WARTUNG & PFLEGE

- A. Bewahren Sie alle Anweisungen und Teile, die sich auf dieses Produkt beziehen, zur späteren Verwendung auf.
- B. Bitte wischen Sie es mit einem trockenen oder feuchten Tuch ab.

ADVERTENCIA:

1. PELIGRO DE ASFIXIA: Incluidas piezas pequeñas. No es adecuado para los niños menores de 3 años.
2. La instalación sólo se puede realizar por los adultos, mantenga a los niños alejados al instalar el producto.
3. El producto debe ser utilizado bajo la supervisión directa de un adulto.
4. Colóquelo sobre un piso plano y limpio. Verifique si todas las piezas estén conectadas adecuadamente antes de utilizarlo.

MANTENIMIENTO Y CUIDADO





- A. Guarde todas las instrucciones y piezas relativas juntas con este producto para las referencias futuras.
- B. Límpielo con un paño seco o humedecido.

AVVERTENZE:

1. RISCHIO DI SOFFOCAMENTO — Parti piccole. Non adatte a bambini sotto i 3 anni.
2. Consentito solo agli adulti di installare, tenere lontani i bambini.
3. Da utilizzare sotto la diretta supervisione di un adulto.
4. Posizionarlo su una superficie piana e pulita, controllare che tutte le parti siano connesse correttamente prima dell'uso.

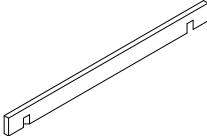
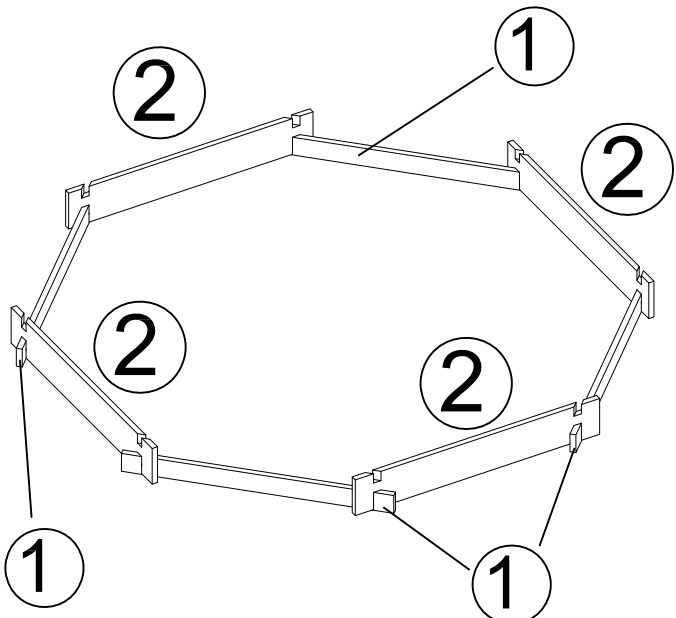
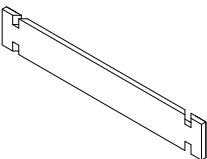
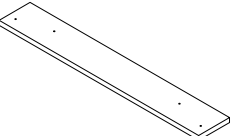
MANUTENZIONE & CURA

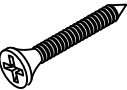
- A. Conservare tutte le istruzioni e le parti relative a questo prodotto per riferimenti futuri.
- B. Si prega di pulire passando un panno asciutto o inumidito.

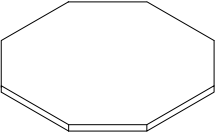
1		8PCS	<div data-bbox="805 67 869 145" style="border: 1px solid black; padding: 2px; display: inline-block;">1</div> 
2		12PCS	
3		4PCS	
4		4PCS	
A	 3*30	16PCS +1(spare)	
B	 3*20	12PCS +1(spare)	
C	 Black geotextile	1PC	
D		1PC	

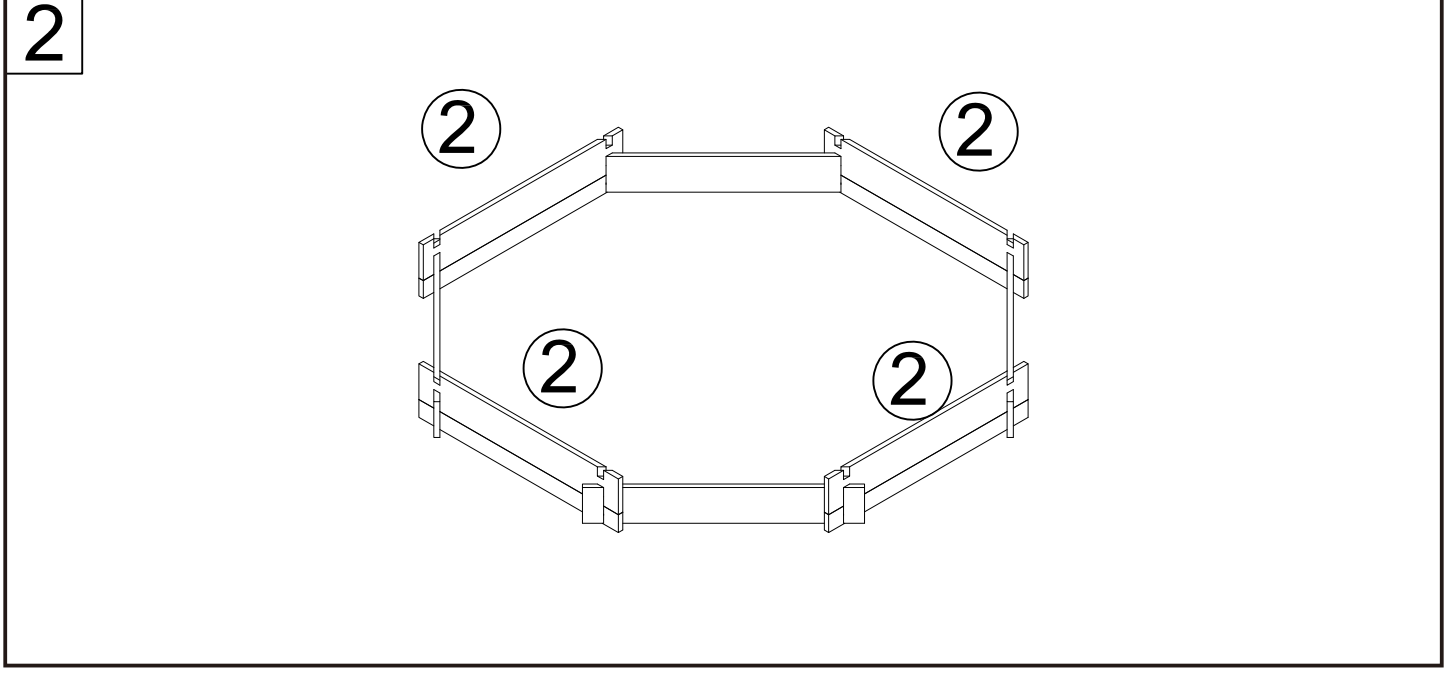

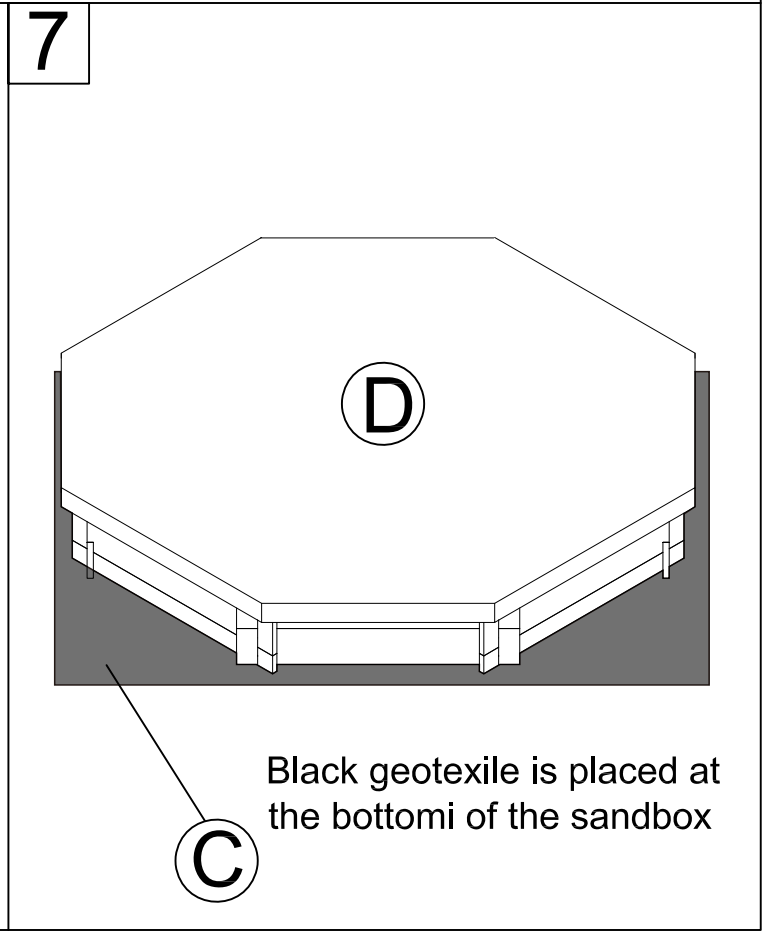
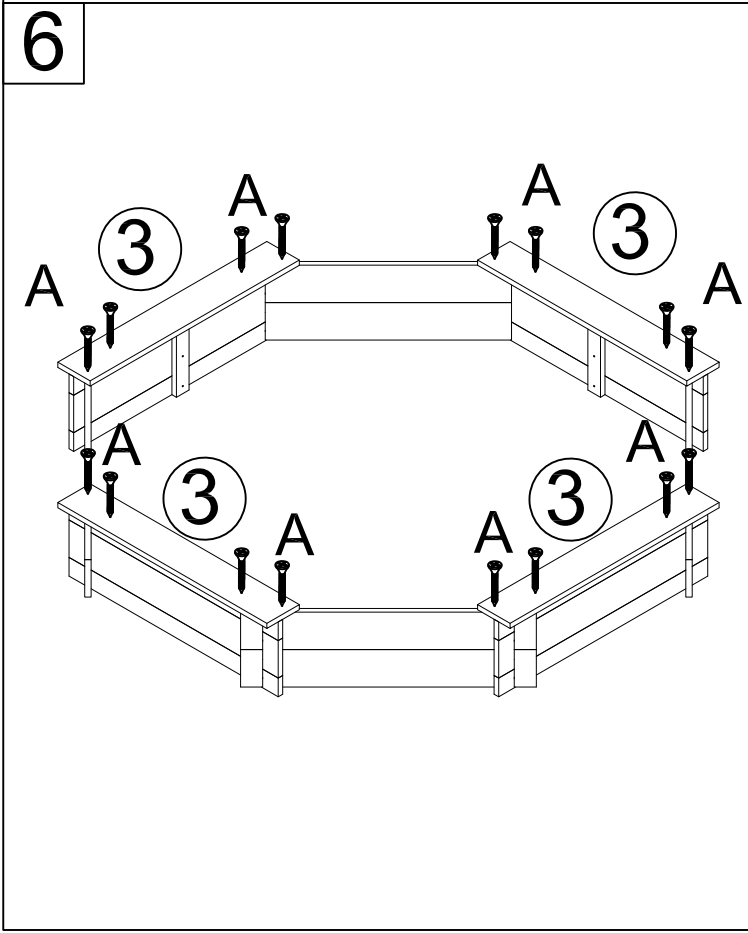
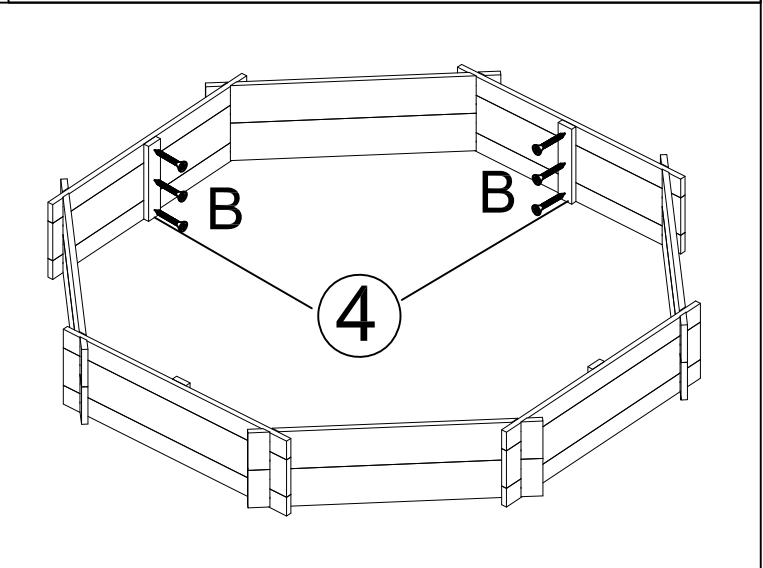
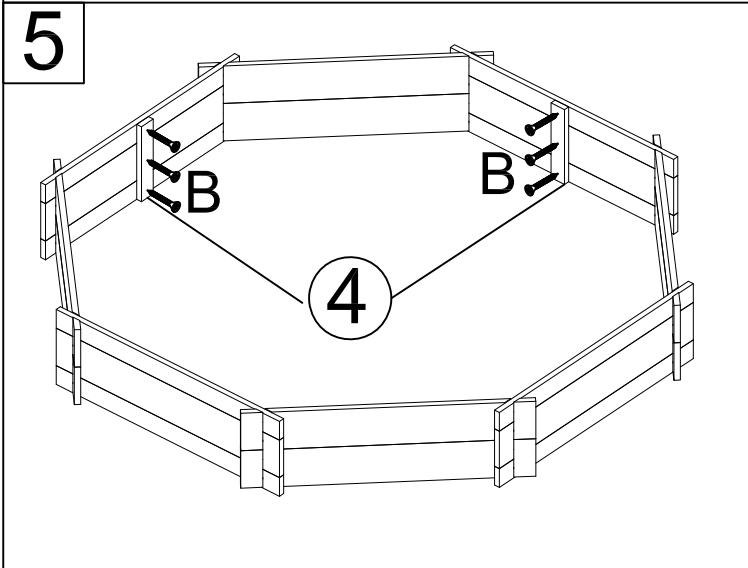
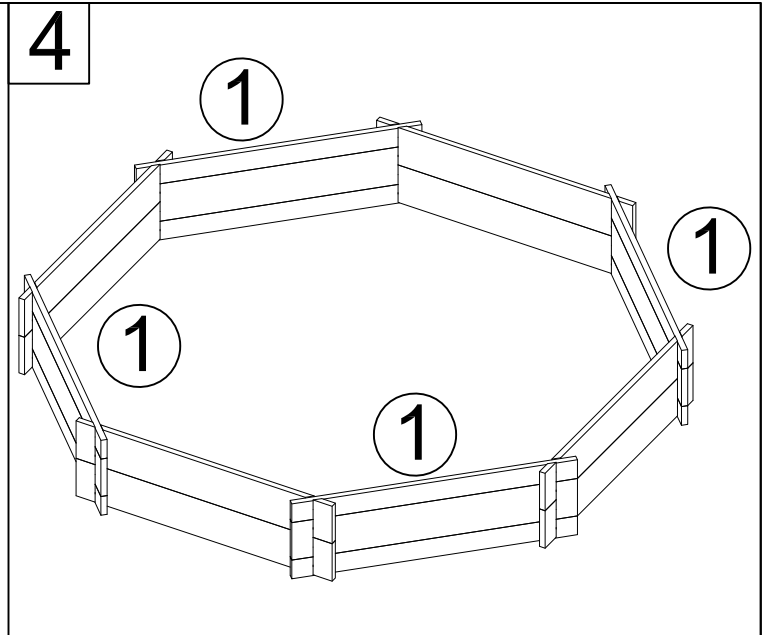
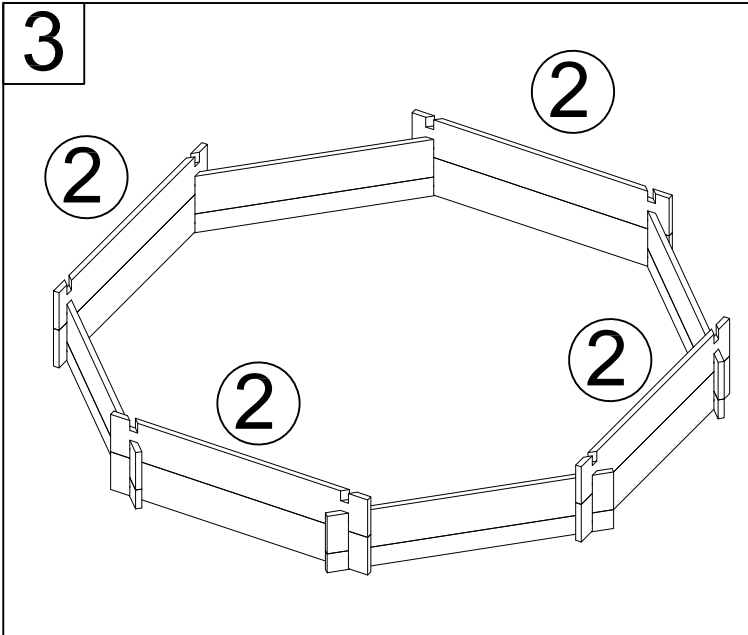

US

If you have any questions, please contact our customer care center.

Our contact details are below:

 001-877-644-9366

 customerservice@aosom.com

Imported by Aosom LLC

27150 SW Kinsman Rd Wilsonville, OR 97070 USA

MADE IN CHINA

ES

Si tiene alguna pregunta, comuníquese con nuestro Centro de Atención al Cliente.

Nuestros datos de contacto son los siguientes:

 0034-931294512

 atencioncliente@aosom.es

Importador/Fabricante/REP:

Spanish Aosom, S.L.

C/ Roc Gros, nº 15. 08550, Els Hostalets de Balenyà, Spain.

B66295775

atencioncliente@aosom.es

TEL: 931294512

HECHO EN CHINA

CA

If you have any questions, please contact our customer care center.

Our contact details are below:

 416-792-6088

 customerservice@aosom.ca

Imported by Aosom Canada Inc.

7270 Woodbine Avenue, Unit 307, Markham,

Ontario Canada

L3R 4B9

MADE IN CHINA

Si vous avez la moindre question, veuillez contacter notre centre d'assistance à la clientèle.

Nos coordonnées sont les suivantes:

 416-792-6088

 customerservice@aosom.ca

Importé par Aosom Canada Inc.

7270 Woodbine Avenue, unité 307,

Markham, Ontario Canada

L3R 4B9

FABRIQUÉ EN CHINE

PT

Se tiver alguma dúvida, por favor contacte o nosso Centro de Atendimento ao Cliente.

Os nossos dados de contacto são os seguintes:

 0034-931294512 (SEG-SEX DAS 7:30H ÀS 16:30H)

 info@aosom.pt.

IMPORTADOR:

SPANISH AOSOM, S.L



C.ROC GROS N.15, 08550. ELS HOSTALETS DE BALENYÀ

WWW.AOSOM.PT

DE

Wenn Sie Fragen haben, wenden Sie sich bitte an unser Kundendienstzentrum.

Unsere Kontaktdaten stehen unten:

 0049-0(40)-88307530  service@aosom.de

Importeur/Hersteller/REP:

MH Handel GmbH

Wendenstraße 309

D-20537 Hamburg

Germany

IN CHINA HERGESTELLT

UK

If you have any questions, please contact our customer care center.

Our contact details are below:

 0044-800-240-4004

 enquiries@mhstar.co.uk

IMPORTER ADDRESS:

MH STAR UK LTD

Unit 27, Perivale Park,

Horsenden lane South

Perivale, UB6 7RH

MADE IN CHINA

IT

In caso di dubbio, si prega di contattare il nostro centro assistenza clienti.

I nostri dettagli di contatto sono di seguito:

 0039-0249471447  clienti@aosom.it

IMPORTATO DA/Produttore/REP:

AOSOM Italy srl

Centro Direzionale Milanofiori

Strada 1 Palazzo F1

20057 Assago (MI)

P.I.: 08567220960

FATTO IN CINA

FR

Si vous avez la moindre question, veuillez contacter notre centre d'assistance à la clientèle.

Nos coordonnées sont les suivantes:  0033-1-84166106  aosom@mhfrance.fr

Importé par/Fabricant/REP:

MH France

2, rue Maurice Hartmann

92130 Issy-les-Moulineaux

France

Fabriqué en Chine

**FR**

DONNEZ
OU
RECYCLEZ



OU

ASSOCIATION



OU

LIVRAISON



DÉCHÈTERIE

Adresses sur quefairedemesdechets.fr

