



- \* Suitable for children of 18-36 months.
- \* Max weight: 25 kg.



Please according to the actual one in the box, the picture is for reference.

**IMPORTANT, RETAIN FOR FUTURE REFERENCE: READ CAREFULLY**

# ASSEMBLY INSTRUCTION













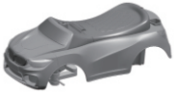





## **WARNING:**

1. CHOKING HAZARD—Small parts.
2. Only allowed for adults to install, keep children away.
3. To be used under the direct supervision of an adult.
4. Just only allow one child to use.
5. Please use on a flat and clean surface. Never use near steps, sloped driveways, hills roadways, alleys, swimming pool areas, road, on grass or wet surfaces or other bodies of water.
6. Before driving toy car each time, adult should inspect screws of every parts, please tighten the screw cap if any looseness. secure all fasteners before every ride.
7. Always wear shoes and suitable protective equipment. always wear a local standard approved helmet while riding, with the chinstrap securely fastened.
8. Do not ride the product at dusk, at night or at times of limited visibility.
9. Always comply with local laws and regulations.

## **MAINTENANCE & CARE**

- A. Keep all instructions and parts relating to this product for future reference.
- B. Regularly check for damage and that all screws are securely tightened.
- C. Check that the seat is securely fastened.
- D. Lubricate the chain as often as required.
- E. Regularly check tyre pressures.

SPARE PARTS PICTURE

	SPARE PARTS	PICTURE	QTY		SPARE PARTS	PICTURE	QTY
1	CAR BODY		1	9	BACKREST		1
2	WHEEL		4	10	washer	 Ø17*1.5	4
3	WHEEL Cover		4	11	NUT	 M5	1
4	ANTI-TURNOVER		1	12	screw	 M5*35	1
5	STEERING AXLE		1	13	screw	 M4*16	2
6	STEERING SETS		1	14	screw	 M3*12	1
7	REAR AXLE		1	15	CLIP		3
8	STEERING WHEEL		1	16	MANUAL		1

**\*NOTE:**Some parts have already been installed on the main body.

## INSTALLATION

### 1. INSTALL STEERING SETS

FIRST REMOVE 2 SCREWS FROM CAR BODY, AND PUT THEM ASIDE, THEN PUT THE STEERING SETS ON THE CAR BODY, LIKE THE FOLLOWING PICTURE SHOWS, USE 2 SCREWS TO FIX IT.

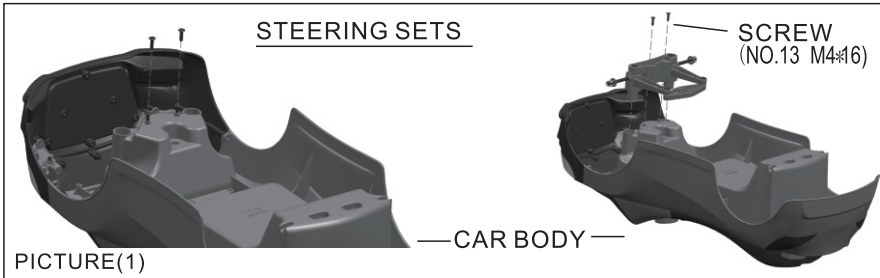

### 2. INSTALL STEERING WHEEL

FIRST REMOVE THE SCREW AND NUT FROM THE STEERING WHEEL, AND PUT THEM ASIDE, GET THROUGH THE STEERING AXLE FROM BOTTOM INTO THE TOP OF THE CAR BODY, FIX THE STEERING WHEEL WITH THE AXLE BY THE SCREW AND NUT.

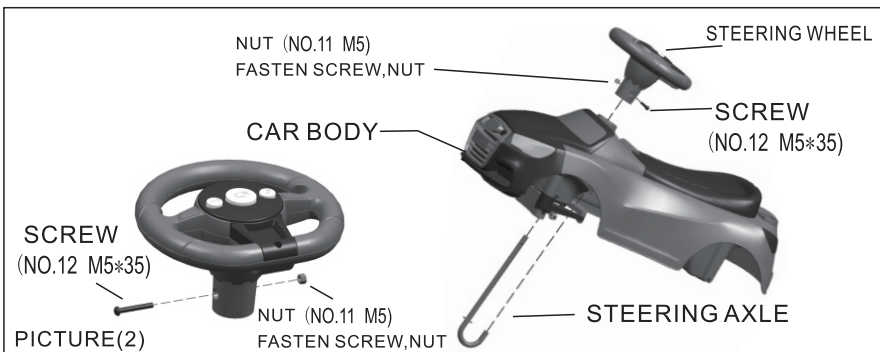

### 3. INSTALL FRONT WHEELS

FIRST REMOVE THE CLIP AND WASHER FROM THE AXLE, PUT ON THE WHEEL, THEN FIX BY WASHER AND CLIP, AT LAST, LOCK THE WHEEL COVER ON THE WHEEL.

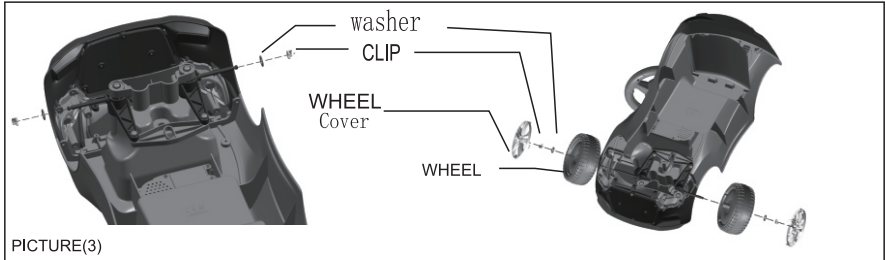

4. PUT THE ANTI-TURNOVER ONTO THE BOTTOM OF THE CAR BODY LIKE PICTURE 4 SHOWS.

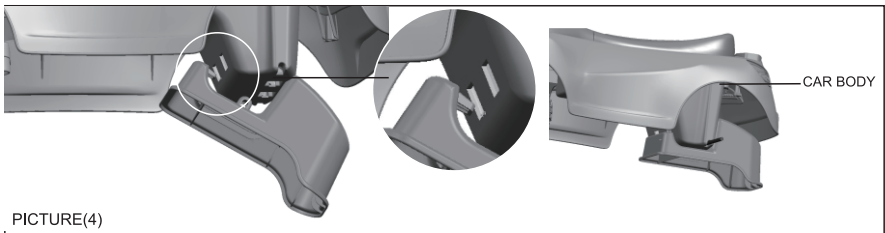

### 5. FIX THE BACK WHEELS

FIRST REMOVE THE CLIP AND WASHERS FROM THE REAR AXLE, AND FIX THE AXLE AND WHEELS ON THE CAR BODY LIKE THE PICTURE(5) SHOWS.

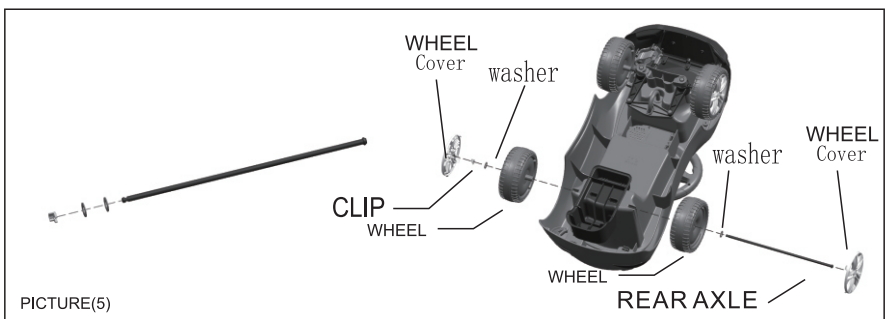

## 6. INSTALL BACKREST

JUST INSERT THE BACKREST INTO THE CAR BODY LIKE THE PICTURE SHOWS



7. OPEN THE BATTERY BOX COVER BY SCREW DRIVER, AND PUT 2PCS OF BATTERY WITH AA SIZE IN THE BOX ACCORDING TO THE RIGHT POLE, FIX BACK THE COVER.

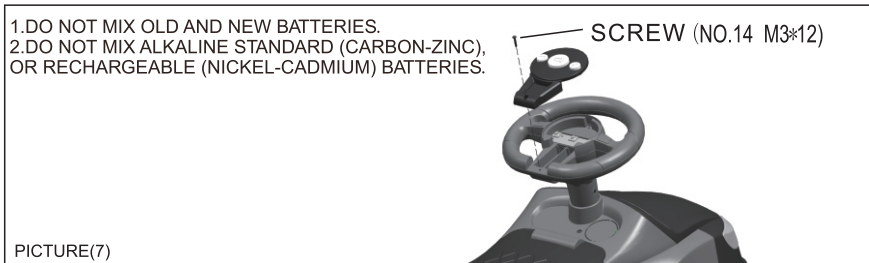

## USING INSTRUCTION:

1. MAKE SURE FOLLOWING POINTS HAVE BEEN DONE BEFORE USE.

- INSTALL THE CAR ACCORDING TO THE MANUAL;
  - ALL SPOTS WITH SCREWS MUST BE TIGHT ENOUGH.
2. TO REDUCE THE DANGERS, THE CHILDREN MUST BE GIVEN SAFETY EDUCATION BY PARENTS OR GUARDIAN BEFORE USE.
- THE SEAT MUST BE TAKEN WHEN STEERING THE WHEEL.
  - EVERY TIME USE THE CAR ONLY FOR ONE CHILD.
  - IN CASE OF ACCIDENT, THE GUARDIAN MUST BE ALWAYS MONITORING IT DURING THE CAR IS USING.
  - PLEASE BE AWARE OF THE USING PLACE, THE GROUND MUST BE HARD, AND THE PLACE MUST BE WIDE OPEN, UNSAFELY PLACE IS FORBIDDEN.
  - AVOID USING THE CAR IN THE DARK, ONLY USE IN THE DAYTIME, AND IN THE BRIGHT AREA.



- \* Convient aux enfants de 18 à 36 mois .
- \* Poids maximum : 25 kg.



l'image est a titre de reference, veuillez vous référer au modèle réel dans la boîte.

**IMPORTANT: LIRE ATTENTIVEMENT ET CONSERVEZ CE MANUEL  
POUR VOUS Y REFERER ULTERIEUREMENT**

**Assemblage & manuel d'instructions**

**AVERTISSEMENT :**

1. DANGER D'ÉTOUFFEMENT - Petites pièces.
2. Installation par des adultes uniquement, tenir les enfants à l'écart.
3. À utiliser sous la surveillance directe d'un adulte.
4. Ne doit être utilisé que par un seul enfant à la fois.
5. À utiliser sur une surface plane et propre. Ne jamais utiliser à proximité d'un escalier, d'une entrée en pente, d'une route en pente, d'une allée, d'une piscine, d'une route, sur l'herbe ou sur des surfaces mouillées ou d'autres plans d'eau.
6. Avant de conduire à chaque fois le jouet, l'adulte doit inspecter les vis de chaque pièce, veuillez serrer le bouchon à vis s'il est desserré. Fixez toutes les attaches avant chaque trajet.
7. Portez toujours des chaussures et un équipement de protection approprié. Portez toujours un casque homologué selon les normes locales pendant que vous roulez, avec la jugulaire solidement attachée.
8. Ne pas rouler au crépuscule, la nuit ou à des heures de visibilité réduite.
9. Respectez toujours les lois et règlements locaux.

**ENTRETIEN ET MAINTENANCE**

- A. Conservez toutes les instructions et les pièces relatives à ce produit pour pouvoir vous y référer ultérieurement.
- B. Vérifiez régulièrement que le produit n'est pas endommagé et que toutes les vis sont bien serrées.
- C. Vérifier que le siège est bien fixé.
- D. Lubrifiez la chaîne aussi souvent que nécessaire.
- E. Vérifiez régulièrement la pression des pneus.



## IMAGES DES PIÈCES DÉTACHÉES

	PIÈCES DÉTACHÉES	IMAGE	QTÉ		PIÈCES DÉTACHÉES	IMAGE	QTÉ
1	CARROSSE RIE		1	9	DOSSIER		1
2	ROUE		4	10	Rondelle	 Ø17*1.5	4
3	ENJOILIVEUR		4	11	ÉCROU	 M5	1
4	ANTI-RETOURNEMENT		1	12	Vis	 M5*35	1
5	AXE DE DIRECTION		1	13	Vis	 M4*16	2
6	KIT DE DIRECTION		1	14	Vis	 M3*12	1
7	AXE ARRIÈRE		1	15	CLIP		3
8	VOLANT DE DIRECTION		1	16	MANUEL		1

**\*REMARQUE:** Certaines pièces ont déjà été installées sur le corps principal.

## INSTALLATION

### 1. INSTALLER LES KITS DE DIRECTION

ENLEVEZ D'ABORD 2 VIS DE LA CARROSSERIE ET METTEZ-LES DE CÔTÉ, PUIS PLACEZ LES KITS DE DIRECTION SUR LA CARROSSERIE, COMME INDIQUÉ SUR L'IMAGE SUIVANTE, EN UTILISANT 2 VIS POUR LES FIXER.

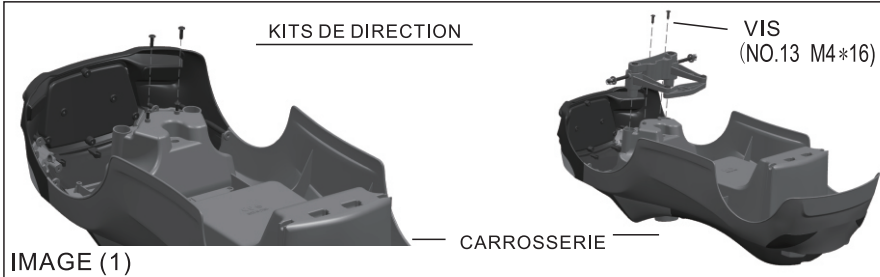

### 2. INSTALLATION DU VOLANT

RETIRER D'ABORD LA VIS ET L'ÉCROU DU VOLANT ET LES METTRE DE CÔTÉ. PASSER L'AXE DE LA DIRECTION DU BAS VERS LE HAUT DE LA CARROSSERIE ET FIXER LE VOLANT À L'AXE À L'AIDE DE LA VIS ET DE L'ÉCROU.

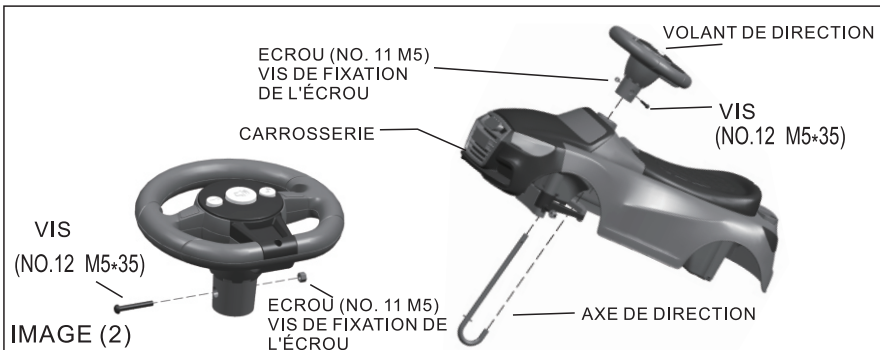

### 3. INSTALLATION DES ROUES AVANT

ENLEVEZ D'ABORD LE CLIP ET LA RONDELLE DE L'ESSIEU, METTEZ LA ROUE, PUIS FIXEZ-LA AVEC LA RONDELLE ET LE CLIP, ENFIN, BLOQUEZ L'ENJOLIVEUR SUR LA ROUE.

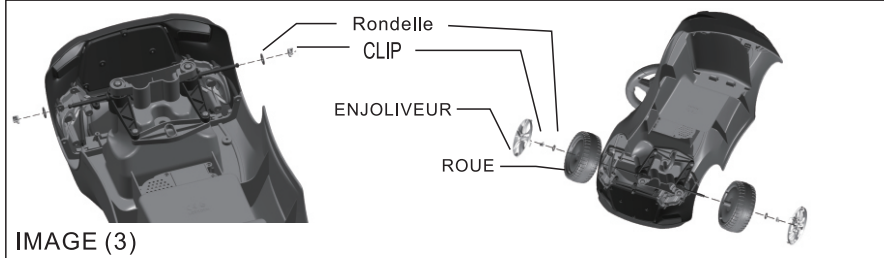

IMAGE (3)

4. POSEZ L'ANTI-RETOUR SUR LA PARTIE INFÉRIEURE DE LA CARROSSERIE DE LA VOITURE, COMME INDICÉ SUR L'IMAGE 4.

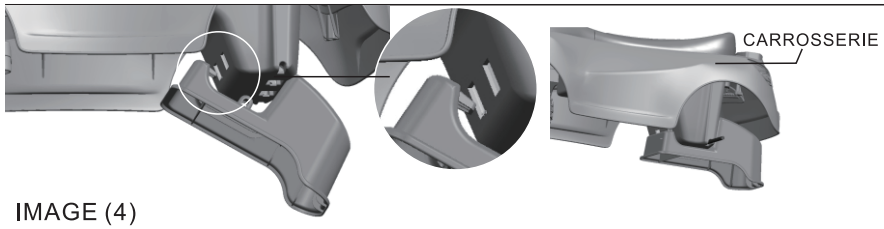

IMAGE (4)

### 5. FIXATION DES ROUES ARRIÈRE

ENLEVEZ D'ABORD LE CLIP ET LES RONDELLES DE L'ESSIEU ARRIÈRE, PUIS FIXEZ L'ESSIEU ET LES ROUES SUR LA CARROSSERIE COMME INDICÉ SUR L'IMAGE (5).

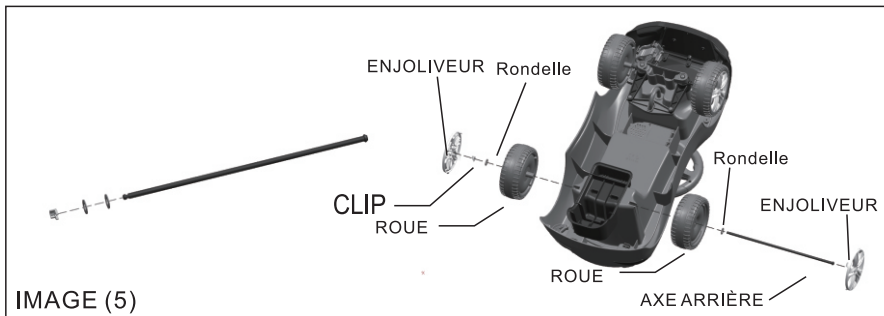

IMAGE (5)

## 6. INSTALLER LE DOSSIER

IL SUFFIT SEULEMENT D'INCUSTRER LE DOSSIER DANS LA CARROSSERIE DE LA VOITURE COMME LE MONTRE L'IMAGE.



IMAGE (6)

7. OUVREZ LE COUVERCLE DU BOÎTIER DE LA BATTERIE À L'AIDE D'UN TOURNEVIS, ET METTEZ 2 BATTERIES DE TAILLE AA DANS LE BOÎTIER SELON LE PÔLE DROIT, PUIS REMETTEZ LE COUVERCLE EN PLACE.

1. NE PAS MÉLANGER LES PILES NEUVES ET ANCIENNES.
2. NE PAS MÉLANGER LES PILES ALCALINES STANDARD (CARBONE-ZINC) ET LES PILES RECHARGEABLES (NICKEL-CADMIUM).

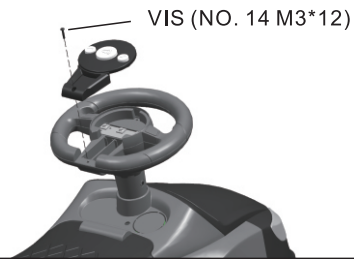

IMAGE (7)

## INSTRUCTIONS D'UTILISATION :

1. ASSUREZ-VOUS QUE LES ÉTAPES SUIVANTES ONT ÉTÉ RÉALISÉES AVANT L'UTILISATION.
  - INSTALLEZ LA VOITURE CONFORMÉMENT AU MANUEL ;
  - TOUTES LES VIS DOIVENT ÊTRE SUFFISAMMENT SERRÉES.
2. POUR RÉDUIRE LES RISQUES, LES ENFANTS DOIVENT ÊTRE SENSIBILISÉS À LA SÉCURITÉ PAR LEURS PARENTS OU LEUR TUTEUR AVANT L'UTILISATION.
  - S'ASSEOIR SUR LE SIÈGE QUAND ON TOURNE LE VOLANT.
  - A CHAQUE UTILISATION, LA VOITURE NE PEUT ACCUEILLIR QU'UN SEUL ENFANT.
  - POUR ÉVITER LES ACCIDENTS, LA PERSONNE RESPONSABLE DE L'ENFANT DOIT ÊTRE PRÉSENTE PENDANT L'UTILISATION DE LA VOITURE.
  - FAITES ATTENTION À L'ENDROIT OÙ VOUS UTILISEZ LA VOITURE, LE SOL DOIT ÊTRE DUR, ET L'ESPACE BIEN DÉGAGÉ, LES ENDROITS NON SÉCURISÉS SONT INTERDITS.
  - ÉVITEZ D'UTILISER LA VOITURE DANS L'OBSCURITÉ, NE L'UTILISEZ QUE DE JOUR, ET DANS UNE ZONE ÉCLAIRÉE.



- \* Geeignet für Kinder im Alter von 18-36 Monate.
- \* Max Gewicht: 25 kg.



bitte richten sie sich nach dem tatsächlichen wagen im karton, das bild dient nur als referenz.

**WICHTIG, FÜR DIE SPÄTERE VERWENDUNG AUFBEWAHREN:  
SORGFÄLTIG DURCHLESEN**

**MONTAGEANWEISUNGEN**

**WARNUNG:**

1. ERSTICKUNGSGEFAHR-Kleine Teile.
  2. Die Montage darf nur von Erwachsenen vorgenommen werden, halten Sie Kinder fern.
3. Es ist unter der direkten Aufsicht eines Erwachsenen zu verwenden.
4. Erlauben Sie jeweils nur einem Kind es zu benutzen.
5. Verwenden Sie es bitte auf einer ebenen und sauberen Oberfläche. Es sollte niemals in der Nähe von Treppen, steile Auf- oder Abfahrten, hügeligen Straßen, Alleen, Schwimmbadbereichen, Straßen, auf Gras oder nassen Oberflächen oder anderen Gewässern benutzt werden.
6. Vor jeder Nutzung des Spielzeugautos sollte ein Erwachsener die Schrauben aller Teile überprüfen. Ziehen Sie bitte die Schraubenkappen fest, wenn sie locker sind. Überprüfen Sie vor jeder Fahrt alle Befestigungselemente.
7. Es sollten immer Schuhe und eine geeignete Schutzausrüstung getragen werden. Während der Fahrt sollte immer ein gemäß der örtlichen Norm zugelassener Helm getragen werden, dessen Kinnriemen fest sitzt.
8. Nicht während der Dämmerung, bei Nacht oder bei eingeschränkter Sicht mit dem Produkt fahren.
9. Beachten Sie stets die örtlichen Gesetze und Vorschriften.

**WARTUNG & PFLEGE**

- A. Bewahren Sie alle Anweisungen und Teile, die sich auf dieses Produkt beziehen, zur späteren Verwendung auf.
- B. Prüfen Sie es regelmäßig auf Beschädigungen und ob alle Schrauben fest angezogen sind.
- C. Prüfen Sie, ob der Sitz sicher befestigt ist.
- D. Schmieren Sie die Kette so oft wie nötig.
- E. Prüfen Sie regelmäßig den Reifendruck.

## ERSATZTEILBILD

	ERSATZTEILE	BILD	ANZAHL		ERSATZTEILE	BILD	ANZAHL
1	KAROSSERIE		1	9	RÜCKENLEHNE		1
2	RAD		4	10	Unterlegscheibe	 Ø17*1.5	4
3	RADABDECKUNG		4	11	MUTTER	 M5	1
4	ÜBERROLLSCHUTZ		1	12	Schraube	 M5*35	1
5	LENKACHSE		1	13	Schraube	 M4*16	2
6	LENKUNGS SÄTZE		1	14	Schraube	 M3*12	1
7	HINTERACHSE		1	15	KLEMME		3
8	LENKRAD		1	16	HANDBUCH		1

\***HINWEIS:** Einige Teile wurden bereits am Hauptkörper installiert.

## MONTAGE

### 1. LENKUNGSSÄTZE MONTIEREN

ENTFERNEN SIE ZUERST 2 SCHRAUBEN VON DER KAROSSERIE UND LEGEN SIE SIE BEISEITE. SETZEN SIE DANN DIE LENKUNGSSÄTZE AUF DIE KAROSSERIE, WIE IN DER FOLGENDEN ABBILDUNG GEZEIGT, VERWENDEN SIE 2 SCHRAUBEN ZUR BEFESTIGUNG.



### 2. LENKER MONTIEREN

ENTFERNEN SIE ZUERST DIE SCHRAUBE UND DIE MUTTER VOM LENKRAD UND LEGEN SIE SIE BEISEITE. FÜHREN SIE DIE LENKACHSE VON UNTEN NACH OBEN IN DIE KAROSSERIE EIN UND BEFESTIGEN SIE DAS LENKRAD MIT DER ACHSE MIT DER SCHRAUBE UND DER MUTTER.

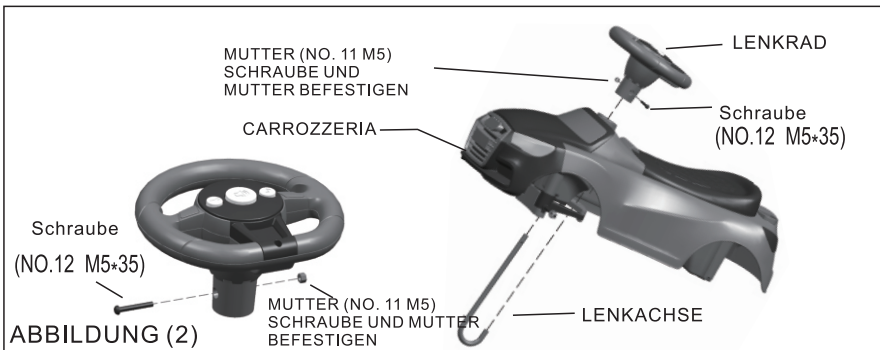



### 3. VORDERRÄDER MONTIEREN

ZUERST DIE KLEMME UND DIE UNTERLEGSCHLEIBE VON DER ACHSE ENTFERNEN, DAS RAD AUFSETZEN, DANN MIT DER UNTERLEGSCHLEIBE UND DER KLEMME BEFESTIGEN, ZULETZT DIE RADABDECKUNG AUF DEM RAD BEFESTIGEN.

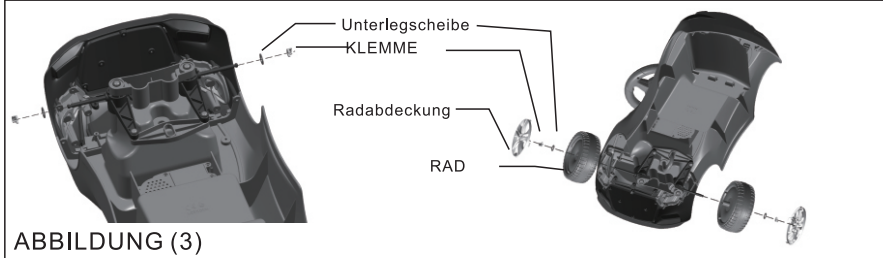

4. BRINGEN SIE DEN ÜBERROLLSCHUTZ AN DER UNTERSEITE DER KAROSSERIE AN, WIE IN DER ABBILDUNG 4 GEZEIGT.

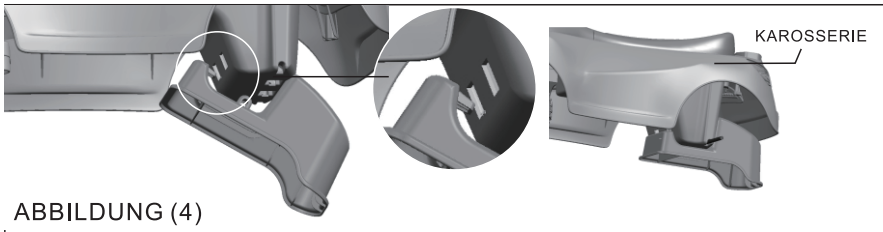

### 5. BEFESTIGEN DER HINTERRÄDER

ENTFERNEN SIE ZUERST DIE KLEMME UND DIE UNTERLEGSCHLEIBEN VON DER HINTERACHSE, UND BEFESTIGEN SIE DIE ACHSE UND DIE RÄDER AN DER KAROSSERIE, WIE IN DER ABBILDUNG (5) GEZEIGT.

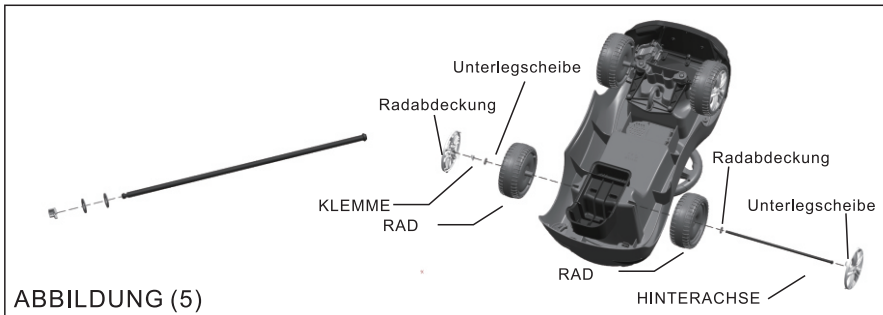

## 6. RÜCKENLEHNE EINBAUEN

SETZEN SIE DIE RÜCKENLEHNE IN DIE KAROSSERIE EIN, WIE IN DER ABBILDUNG GEZEIGT.



ABBILDUNG (6)

7. ÖFFNEN SIE DEN DECKEL DES BATTERIEFACHS MIT EINEM SCHRAUBENZIEHER UND LEGEN SIE 2 STÜCK AA-BATTERIEN MIT DEM RICHTIGEN POL IN DAS FACH EIN, BEFESTIGEN SIE DEN DECKEL WIEDER.

1. VERMISCHEN SIE ALTE UND NEUE BATTERIEN NICHT.
2. MISCHEN SIE KEINE ALKALISCHEN STANDARD-BATTERIEN (KOHLE-ZINK) ODER WIEDERAUFLADBARE BATTERIEN (NICKEL-CADMIUM).



ABBILDUNG (7)

### GEBRAUCHSANWEISUNG:

1. VERGEWISSEN SIE SICH, DASS DIE FOLGENDEN PUNKTE VOR DEM GEBRAUCH DURCHGEFÜHRT WURDEN.
  - MONTIEREN SIE DAS AUTO ENTSPRECHEND DEM HANDBUCH;
  - ALLE STELLEN MIT SCHRAUBEN MÜSSEN FEST ANGEZOGEN SEIN.
2. UM DIE GEFAHREN ZU VERRINGERN, MÜSSEN DIE KINDER VOR DEM GEBRAUCH VON DEN ELTERN ODER ERZIEHUNGSBERECHTIGTEN ÜBER DIE SICHERHEIT UNTERRICHTET WERDEN.
  - DER SITZ MUSS BEIM LENKEN DES RADES EINGENOMMEN WERDEN.
  - BEI JEDEM GEBRAUCH DARF DAS AUTO NUR FÜR EIN KIND VERWENDET WERDEN.
  - IM FALLE EINES UNFALLS MUSS DIE AUFSICHTSPERSON WÄHREND DES GEBRAUCHS DES WAGENS IMMER ANWESEND SEIN.
  - ACHTEN SIE BITTE AUF DEN PLATZ, AN DEM SIE DAS AUTO VERWENDEN. DER BODEN MUSS HART SEIN, UND DER PLATZ MUSS WEIT OFFEN SEIN, UNSICHERE PLÄTZE SIND VERBOTEN.
  - VERMEIDEN SIE ES, DAS AUTO IM DUNKELN ZU BENUTZEN, BENUTZEN SIE ES NUR AM TAG UND IN EINER HELLEN UMGEBUNG.
  - BRINGEN SIE DEN ÜBERROLLSCHUTZ AN DER UNTERSEITE DER KAROSSERIE AN, WIE IN DER ABBILDUNG 4 GEZEIGT.

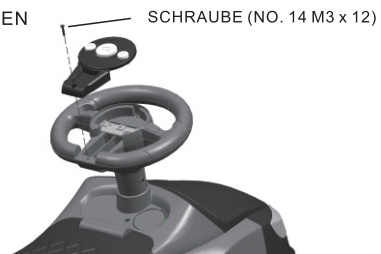

- \* Adecuado para los niños de 18 a 36 meses .
- \* Peso máximo: 25 kg.



Consulte el producto real en la caja, la imagen es solo ilustrativa.

**IMPORTANTE, CONSERVAR PARA FUTURAS CONSULTAS: LEER  
DETENIDAMENTE.**

## INSTRUCCIONES DE MONTAJE

**ADVERTENCIA:**

1. PELIGRO DE ASFIXIA: Incluidas piezas pequeñas.
2. La instalación sólo se puede realizar por los adultos, mantenga a los niños alejados al instalar el scooter.
3. El producto debe ser utilizado bajo la supervisión directa de un adulto.
4. NSólo se permita que un/una niño/a utilice este scooter a la vez.
5. Utilice este scooter sobre una superficie plana y limpia. Nunca lo utilice cerca de escalones, caminos de entrada inclinados, caminos de colinas, callejones, áreas de piscinas, carreteras, sobre césped o superficies mojadas u otros lugares cerca de cuerpos de agua.
6. Antes de conducir este scooter de juguete cada vez, el adulto debe inspeccionar los tornillos de cada pieza del scooter. Si la cubierta de rosca está floja, apriétela bien. Fije todos los sujetadores bien antes de cada uso.
7. Siempre lleve calzado y equipo de protección adecuado al conducir este scooter. Siempre use un casco aprobado por las normas locales al conducir, y fije la correa de la barbilla bien abrochada.
8. No utilice este scooter al anochecer, de noche o en momentos con visibilidad limitada.
9. Siempre cumpla con las leyes y regulaciones locales.

**MANTENIMIENTO Y CUIDADO**

- A. Guarde todas las instrucciones y piezas relativas juntas con este producto para las referencias futuras.
- B. Compruebe regularmente para asegurarse de que no haya daños y que todos los tornillos estén apretados firmemente.
- C. Compruebe que el asiento del scooter esté abrochado firmemente.
- D. Lubrique la cadena frecuentemente si sea necesario.
- E. Compruebe regularmente la presión de los neumáticos.

## IMAGEN DE PIEZAS DE REPUESTO

	PIEZAS DE REPUESTO	IMAGEN	CANTIDAD		PIEZAS DE REPUESTO	IMAGEN	CANTIDAD
1	CARROCERÍA DEL COCHE		1	9	RESPALDO		1
2	RUEDA		4	10	ARANDELA	 Ø17*1.5	4
3	CUBIERTA DE RUEDA		4	11	TUERCA	 M5	1
4	ANTI-VOLCAR		1	12	TORNILLO	 M5*35	1
5	EJE DE DIRECCIÓN		1	13	TORNILLO	 M4*16	2
6	CONJUNTOS DE DIRECCIÓN		1	14	TORNILLO	 M3*12	1
7	EJE TRASERO		1	15	CLIP		3
8	VOLANTE		1	16	MANUAL		1

**\*NOTA:** Algunas piezas ya se han instalado en el cuerpo principal.

## INSTALACIÓN

### 1. INSTALAR LOS CONJUNTOS DE DIRECCIÓN

EN PRIMER LUGAR, quite 2 tornillos de la carrocería del coche, y colóquelos a un lado, luego coloque los conjuntos de dirección en la carrocería del coche como lo que se muestra en la imagen a continuación, finalmente utilice 2 tornillos para fijarlo.



### 2. INSTALAR EL VOLANTE

EN PRIMER LUGAR, quite el tornillo y la tuerca del volante, y colóquelos a un lado, pase el eje de la dirección desde la parte inferior de la carrocería del coche hasta la parte superior de la carrocería del coche, finalmente fije el volante al eje utilizando el tornillo y la tuerca.

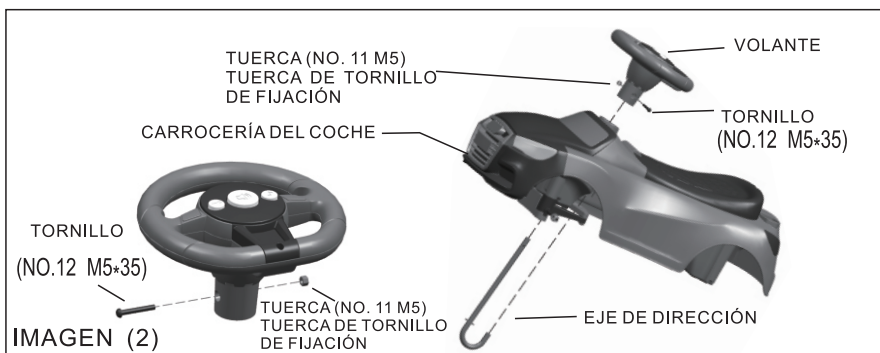

### 3. INSTALAR LAS RUEDAS FRONTALES

EN PRIMER LUGAR, quite el clip y la arandela del eje, coloque la rueda en su lugar y utilice la arandela y clip para fijarla, finalmente bloquee la cubierta de rueda en la rueda.



IMAGEN (3)

4. COLOQUE LA PIEZA DE ANTI-VOLCAR EN LA PARTE INFERIOR DE LA CARROCERÍA DEL COCHE COMO LO QUE MUESTRA LA IMAGEN (4).

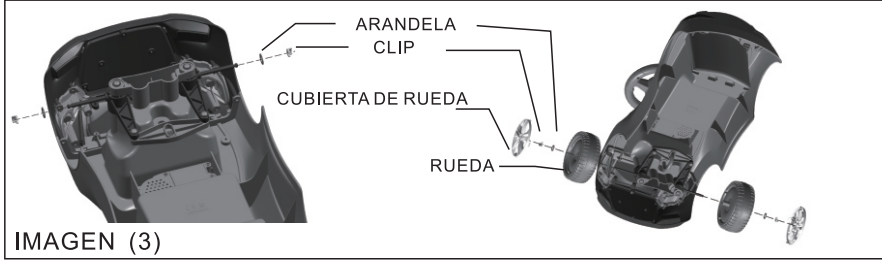

IMAGEN (4)

### 5. FIJAR LAS RUEDAS TRASERAS

EN PRIMER LUGAR, quite el clip y las arandelas del eje trasero, luego fije el eje y las ruedas en la carrocería del coche como lo que se muestra en la imagen (5).

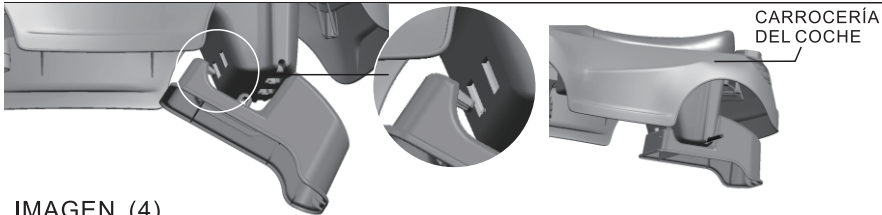

IMAGEN (5)

## 6. INSTALAR RESPALDO

SÓLO INSERTE EL RESPALDO EN LA CARROCERÍA DEL COCHE COMO LO QUE MUESTRA EN LA IMAGEN.

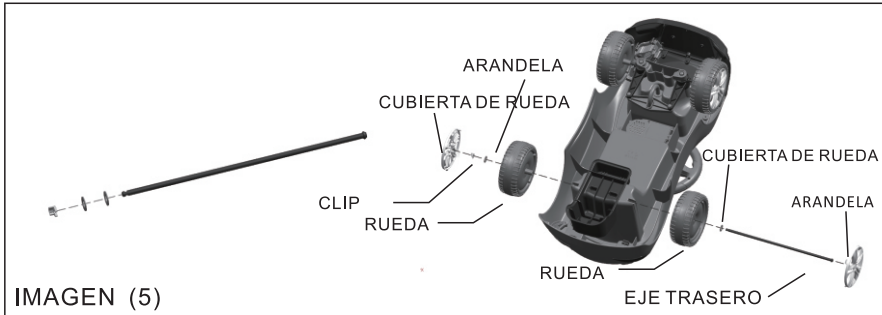

IMAGEN(6)

7. UTILICE UN DESTORNILLADOR PARA ABRIR LA CUBIERTA DE LA CAJA DE BATERÍA, Y COLOQUE 2 BATERÍAS DEL TIPO AA EN LA CAJA CON LAS POLARIDADES CORRECTAS, LUEGO FIJE LA CUBIERTA DE LA CAJA DE BATERÍA.

1. NO MEZCLE LAS BATERÍAS VIEJAS Y NUEVAS.
2. NO MEZCLE LAS BATERÍAS ALCALINAS ESTÁNDAR (CARBONO-ZINC) O RECARGABLES (NÍQUEL-CADMIO).



IMAGEN (7)

### INSTRUCCIONES DE USO:

1. ASEGÚRESE DE CUMPLIR CON TODOS LOS SIGUIENTES PUNTOS ANTES DEL USO.
  - INSTALE EL COCHE DE ACUERDO CON EL MANUAL.
  - APIRIETE TODOS LOS TORNILLOS FIRMEMENTE.
2. POR MOTIVO DE REDUCIR LOS PELIGROS, LOS NIÑOS DEBEN RECIBIR EDUCACIÓN DE SEGURIDAD POR SUS PADRES O EL TUTOR RESPONSABLE ANTES DE UTILIZAR EL COCHE.
  - AL DIRIGIR EL VOLANTE, DEBE SENTARSE EN EL ASIENTO.
  - SOLO UN/A NIÑO/A PUEDE UTILIZAR EL COCHE A LA VEZ.
  - EN CASO DE ACCIDENTE, EL/LA TUTOR/A DEBE ESTAR SIEMPRE SUPERVISANDO AL/A LA NIÑO/A CUANDO ESTÁ UTILIZANDO EL COCHE.
  - TENGA EN CUENTA EL LUGAR DONDE SE UTILIZA EL COCHE, EL TERRENO DEBE SER DURO Y EL ESPACIO DEBE ESTAR MUY ABIERTO. ESTÁ PROHIBIDO UTILIZARLO EN UN LUGAR INSEGURO.
  - ESTÁ PROHIBIDO UTILIZAR EL COCHE EN ENTORNO OSCURO, SOLO SE PUEDE UTILIZARLO DURANTE EL DÍA Y EN LAS ZONAS BIEN ILUMINADAS.



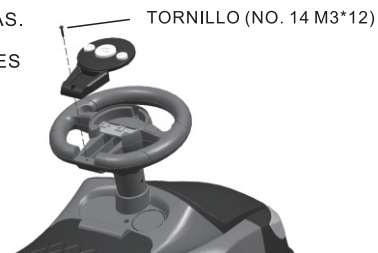

- \* Adatto a bambini di 18-36 mesi.
- \* Peso massimo: 25 kg.



Si prega di fare riferimento al prodotto reale nella confezione, l'immagine è solo di riferimento.

**IMPORTANTE! CONSERVARE IL PRESENTE MANUALE PER FUTURO RIFERIMENTO E LEGGERLO ATTENTAMENTE.**

## ISTRUZIONI DI ASSEMBLAGGIO

**AVVERTENZA:**

1. RISCHIO DI SOFFOCAMENTO — Parti piccole.
2. Consentire l'installazione solo agli adulti, tenere lontani i bambini.
3. Da utilizzare sotto la diretta supervisione di un adulto.
4. Consentire l'uso un bambino alla volta.
5. Si prega di utilizzare su una superficie in piano e pulita. Non usare mai vicino a gradini, passi carrai in pendenza, strade in collina, vicoli, piscine, strade, su erba o superfici bagnate o altre fonti d'acqua.
6. Prima di guidare ogni volta il veicolo, l'adulto dovrebbe ispezionare le viti di tutte le parti, e stringere i dadi in caso di allentamento. Stringere tutti i dispositivi di fissaggio prima di ogni viaggio.
7. Indossare sempre scarpe e dispositivi di protezione adeguati. Indossare sempre un casco approvato dalla normativa locale durante la guida, con il cinturino fissato saldamente.
8. Non guidare il prodotto al crepuscolo, di notte o in momenti di visibilità limitata.
9. Rispettare sempre le leggi e le normative locali.

**MANUTENZIONE & CURA**

- A. Conservare tutte le istruzioni e le parti relative a questo prodotto per riferimenti futuri.
- B. Verificare regolarmente la presenza di danni e che tutte le viti siano strette saldamente.
- C. Verificare che il sedile sia fissato in sicurezza.
- D. Lubrificare la catena tutte le volte che è necessario.
- E. Controllare regolarmente la pressione degli pneumatici.

## FIGURE DELLE PARTI

	COMPONENTE	FIGURA	QTA'		COMPONENTE	FIGURA	QTA'
1	CARROZZERIA		1	9	SCHIENALE		1
2	RUOTA		4	10	RONDELLA	 Ø17*1.5	4
3	CERCHIONE		4	11	DADO	 M5	1
4	ZEPPA ANTI-CAPOTTAMENTO		1	12	VITE	 M5*35	1
5	ASSE DELLO STERZO		1	13	VITE	 M4*16	2
6	CONNETTORE STERZO		1	14	VITE	 M3*12	1
7	ASSE POSTERIORE		1	15	CLIP		3
8	VOLANTE		1	16	MANUALE		1

\***NOTA:** Alcune parti sono già state installate sul corpo principale.

## INSTALLAZIONE

### 1. INSTALLARE LO STERZO

INNANZITUTTO, RIMUOVERE LE 2 VITI DALLA CARROZZERIA E METTERLE DA PARTE, QUINDI POSIZIONARE LO STERZO COME MOSTRATO IN FIGURA SEGUENTE, USANDO 2 VITI PER IL FISSAGGIO.

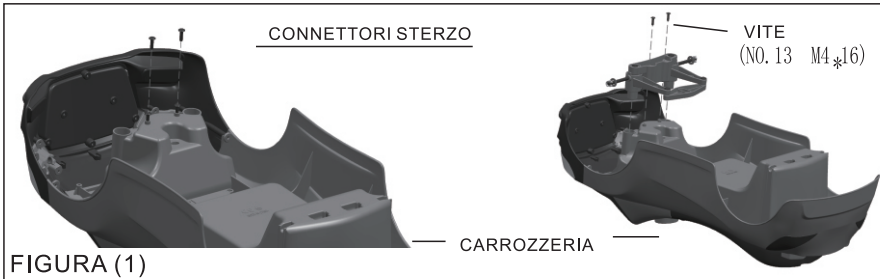

### 2. INSTALLARE IL VOLANTE

INNANZITUTTO, RIMUOVERE PRIMA LA VITE E IL DADO DAL VOLANTE E METTERLI DA PARTE, FARLO PASSARE ATTRAVERSO LA ASSE DELLO STERZO DAL BASSO VERSO L'ALTO NELLA CARROZZERIA, FISSARE IL VOLANTE ALL'ASSE USANDO LA VITE E IL DADO.

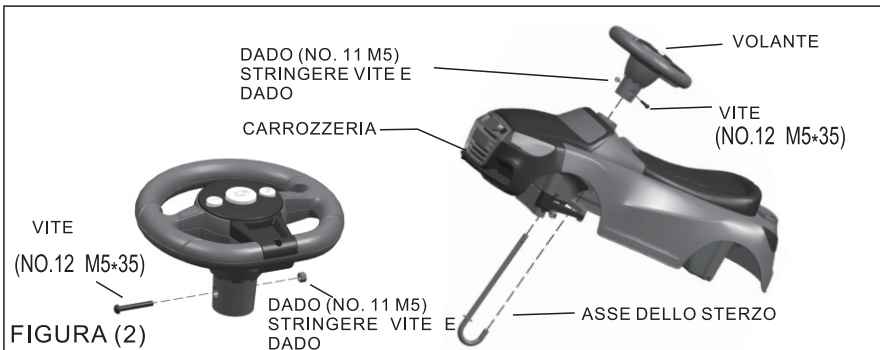

### 3. INSTALLARE LE RUOTE ANTERIORI

INNANZITUTTO, RIMUOVERE LA CLIP E LA RONDELLA DALL'ASSE, INSERIRE LA RUOTA, POI FISSARE USANDO LA RONDELLA E LA CLIP, INFINE FISSARE IL CERCHIONE SULLA RUOTA.



FIGURA (3)

4. INSTALLARE LA ZEPPA ANTI-CAPPOTTAMENTO SUL FONDO DEL VEICOLO COME MOSTRATO IN FIGURA 4.

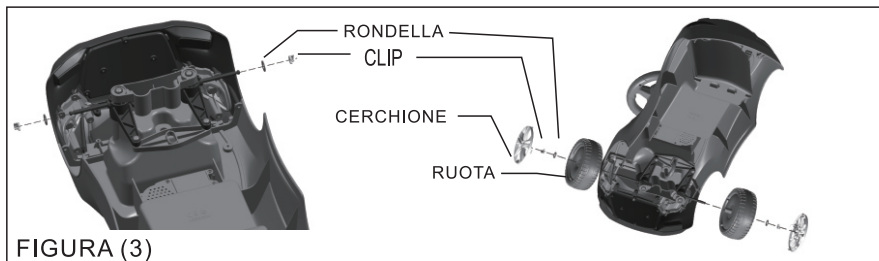

FIGURA (4)

### 5. FISSARE LE RUOTE POSTERIORI

INNANZITUTTO, RIMUOVERE LA CLIP E LE RONDELLE DALL'ASSE POSTERIORE E FISSARE L'ASSE E LE RUOTE ATTRAVERSO LA CARROZZERIA COME MOSTRATO IN FIGURA (5).

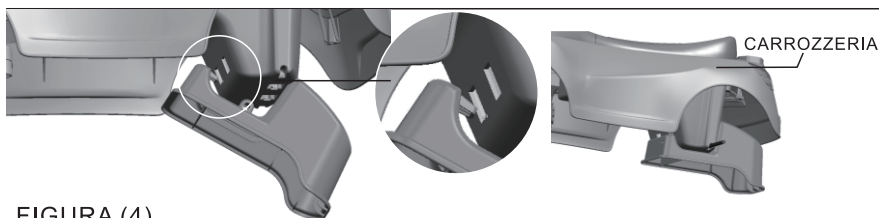

FIGURA (5)

## 6. INSTALLAZIONE DELO SCHIENALE

INSERIRE SEMPLICEMENTE LO SCHIENALE NELLA CARROZZERIA COME MOSTRA IN FIGURA.

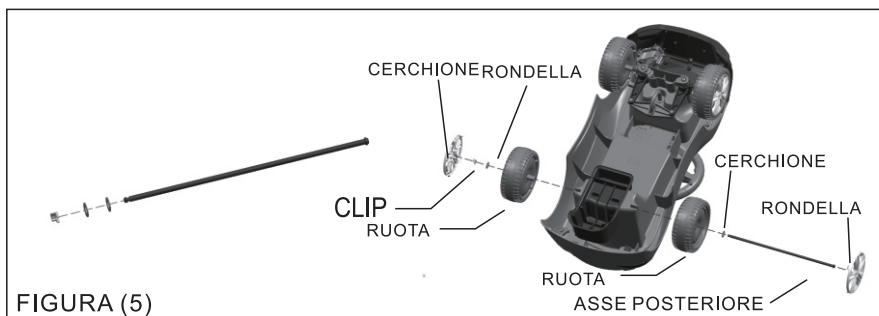

FIGURA (6)

7. APRIRE IL COPERCHIO DEL VANO BATTERIA COPN UN CACCIAVITE E INSERIRE 2 BATTERIE AA NEL VANO SECONDO LA POLARITA' CORRETTA, RIMETTERE IL COPERCHIO.

1. NON MISCHIARE BATTERIE VECCHIE E NUOVE.  
2. NON MESCOLARE BATTERIE ALCALINE STANDARD (CARBON-ZINCO) O RICARICABILI (NICHEL-CADMIO).



FIGURA (7)

### ISTRUZIONI PER L'USO:

1. ASSICURARSI CHE I SEGUENTI PUNTI SIANO STATI ESEGUITI CORRETTAMENTE PRIMA DELL'USO.
  - INSTALLARE IL VEICOLO SECONDO IL MANUALE;
  - TUTTI I RACCORDI CON VITERIA DEVONO ESSERE SUFFICIENTEMENTE STRETTI.
2. PER RIDURRE I PERICOLI, I BAMBINI DEVONO RICEVERE LE ISTRUZIONI SULLA SICUREZZA DAI GENITORI O DAL TUTORE PRIMA DELL'USO.
  - IL SEDILE DEVE ESSERE SALDO QUANDO SI STERZA CON IL VOLANTE.
  - IN OGNI CASO, IL VEICOLO VA USATO SOLO DA BAMBINI.
  - IN CASO DI INCIDENTE, IL TUTORE DEVE SEMPRE MONITORARE IL VEICOLO DURANTE L'USO.
  - SI PREGA DI ESSERE CONSAPEVOLI DEL LUOGO DI GUIDA, IL TERRENO DEVE ESSERE STABILE E IL LUOGO DEVE ESSERE AMPIO E ALL'APERTO, È VIETATO GUIDARE IN UN LUOGO PERICOLOSO.
  - EVITARE DI UTILIZZARE IL VEICOLO AL BUIO, UTILIZZARLO SOLO DI GIORNO E IN UNA ZONA ILLUMINATA.

**UK**

If you have any questions, please contact our customer care center.

Our contact details are below:



0044-800-240-4004



enquiries@mhstar.co.uk

IMPORTER ADDRESS:

MH STAR UK LTD

Unit 27, Perivale Park,

Horsenden lane South

Perivale, UB6 7RH

MADE IN CHINA

**ES**

Si tiene alguna pregunta, comuníquese con nuestro Centro de Atención al Cliente.

Nuestros datos de contacto son los siguientes:



0034-931294512



atencioncliente@aosom.es

IMPORTADOR:

SPANISH AOSOM, S.L.

C/ ROC GROS, N° 15. 08550, ELS HOSTALETES DE

BALENYÀ, SPAIN.

B66295775

WWW.AOSOM.ES

ATENCIONCLIENTE@AOSOM.ES

TEL: 931294512

HECHO EN CHINA

**FR**

Si vous avez la moindre question, veuillez contacter notre centre d'assistance à la clientèle.

Nos coordonnées sont les suivantes:



0033-1-84166106



aosom@mhfrance.fr

Importé par:

MH France

2, rue Maurice Hartmann

92130 Issy-les-Moulineaux

France

Fabriqué en Chine

**PT**

Se tiver alguma dúvida, por favor contacte o nosso Centro de Atendimento ao Cliente.

Os nossos dados de contacto são os seguintes:



0034-931294512



atencioncliente@aosom.es

IMPORTADOR:

SPANISH AOSOM, S.L

C.ROC GROS N.15, 08550. ELS HOSTALETES DE BALENYÀ

TEL: 931294512 (SEG-SEX DAS 7:30H ÀS 16:30H)

INFO@AOSOM.PT

WWW.AOSOM.PT

**DE**

Wenn Sie Fragen haben, wenden Sie sich bitte an unser Kundendienstzentrum.

Unsere Kontaktdaten stehen unten:



0049-0(40)-88307530



service@aosom.de

ADRESSE DES IMPORTEUR:

MH Handel GmbH

Wendenstraße 309

D-20537 Hamburg

Germany

IN CHINA HERGESTELLT

**IT**

In caso di dubbio, si prega di contattare il nostro centro assistenza clienti.

I nostri dettagli di contatto sono di seguito:



0039-0249471447



clienti@aosom.it

IMPORTATO DA:

AOSOM Italy srl

Centro Direzionale Milanofiori

Strada 1 Palazzo F1

20057 Assago (MI)

P.I.: 08567220960

FATTO IN CINA



Adresses sur [quefairedemesdechets.fr](http://quefairedemesdechets.fr)

Aosom