

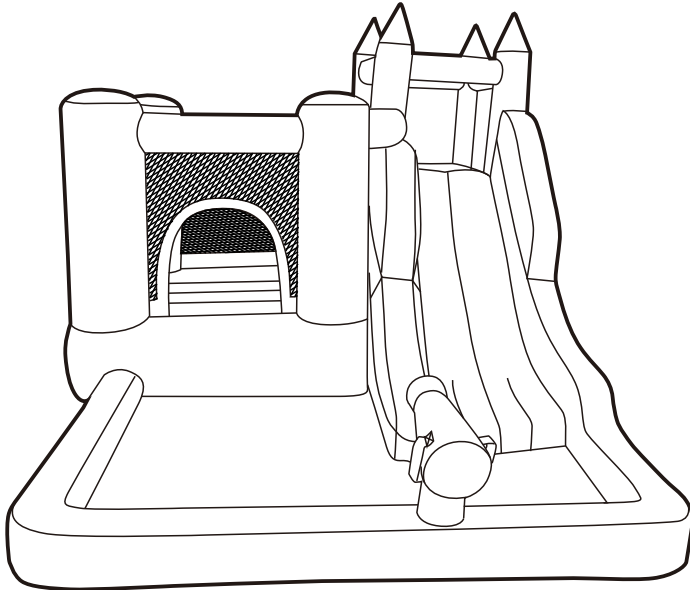

EN

# HOME USE INFLATABLE BOUNCER

342-018V80



Instructions for installation and operation

## Package includes:

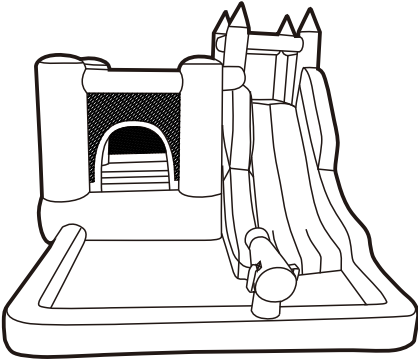

(a)



(b)

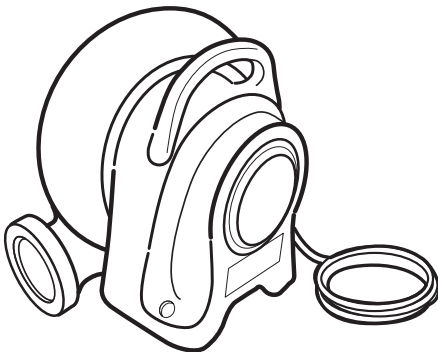

(c)

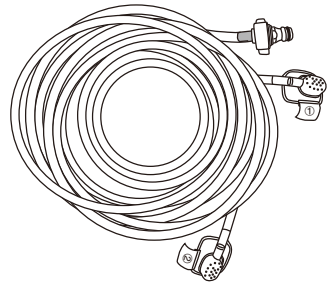

(d)



(e)



(f)

### CONTENTS

(a) Inflatable bouncer

(b) Carrying Bag

(c) Blower (450W)

(d) Water pipe

(e) Blower stakes

(f) Bouncer stakes

**CAUTION - ELECTRICALLY OPERATED PRODUCT OPERATION OF BLOWER FAN UNIT NOT RECOMMENDED FOR CHILDREN UNDER 8 YEARS OF AGE. AS WITH ALL ELECTRONIC PRODUCTS PRECAUTIONS SHOULD BE OBSERVED DURING HANDLING AND USE TO PREVENT ELECTRIC SHOCK.**

**⚠ WARNING: FAILURE TO FOLLOW THESE INSTRUCTIONS COULD RESULT IN SERIOUS INJURY OR DEATH.**

Do not use extension cords with this product. Outdoor use only  
Read all instructions before assembling this inflatable device. Keep instructions for future use.

**⚠ WARNING**

**ELECTROCUTION RISK**

- KEEP ALL ELECTRICAL LINES, RADIOS, SPEAKERS AND OTHER ELECTRICAL DEVICES AWAY FROM THE CONSTANT AIR INFLATABLE
- DO NOT PLACE THE CONSTANT AIR INFLATABLE NEAR OR UNDER OVERHEAD ELECTRICAL LINES.

**⚠ WARNING**

**Prevent Drowning**



Children- especially toddlers- are at high risk of drowning. Closely watch children who are in or near this Constant Air Inflatable. Empty water from Constant Air Inflatable after use.

**⚠ WARNING**

**No Diving**



You can break your neck and be paralyzed!

Children, especially toddlers, are at high risk of drowning. Closely watch children who are in or near this Constant Air Inflatable. Empty water from Constant Air Inflatable after use.

**Drowning Risk**

- Keep unsupervised children from accessing the pool by installing fencing or other approved barrier around all sides of the waterpark.
- State or local laws or codes may require fencing or other approved barriers. Check state or local laws and codes before setting up the waterpark.
- Drowning occurs silently and quickly. Assign an adult to supervise the waterpark.

- Keep children in your direct sight when they are in or near the waterpark and when you are fling and emptying the water park.
- When searching for a missing child, check the pool first, even if you think your child is in the house.

**First Aid**

- Keep a working phone and list of emergency numbers near the waterpark.
- Become certified in cardiopulmonary resuscitation (CPR) So you can respond to an emergency.

**! WARNING**

Electrocution Hazard-DO NOT USE EXTENSION CORDS WITH THIS PRODUCT.

**! WARNING**

Follow Anchoring Instructions User must read and follow anchoring instructions to ensure the proper: number of anchors used, soil conditions, and stake installation.

**! WARNING**

Yes No Yes No

**Wind Speed Judgement**

No head-first sliding. Always slide feet-first.  
 No shoes or glasses are to be worn on the inflatable device.  
 Any restrictions related to operating in windy conditions.  
 Adult supervision recommended.

**WARNING:**  
 Failure to follow the installation and operating instructions present a risk of serious injury or death.

Use on flat grass and non-hard ground. Do not use in windy and rainy weather.  
 Do not contact water with electric wire air pump.  
 MAXIMUM TOTAL WEIGHT MUST NOT EXCEED 120 KG(265LBS).  
 Suitable age range: from 3 years to 8 years old.

**This product is not a toy. Children must be supervised by an adult at all times, when using this product. READ AND SAVE THESE INSTRUCTIONS.**

## Safety Warnings: ELECTRICAL BLOWER

# DANGER!

 CAUTION: ELECTRICALLY OPERATED PRODUCT

 **DANGER - TO PREVENT ELECTRIC SHOCK, DO NOT IMMERSE IN WATER. WIPE CLEAN WITH DAMP CLOTH.**

 **WARNING: FAILURE TO FOLLOW THESE INSTRUCTIONS COULD RESULT IN SERIOUS INJURY OR DEATH. ADULT SETUP AND SUPERVISION REQUIRED.**

 **CAUTION: This blower is high volume and can move lots of air quickly. Place the blower in an area where it will not suck in dirt or leaves. Keep away from water and congested areas. Keep children away from the blower. Only use the provided blower for inflation.**

### Instructions For Blower Installation

**NOTE:** Set up as close to the power source as possible. The product should be occasionally examined for a damaged cord, plug, housing or parts. If damage is found, do not use until properly repaired. Never leave the blower outside in the rain. When in use, do not place the cord across water, congested or damp areas. The blower should be placed on a stable surface and anchored per product instructions. The power cord of the blower is equipped with a Ground Faulty Current Interrupter (GFCI) plug.

- 1) Make sure that the blower switch is in the 'OFF' position. Plug the blower into a properly grounded 110-120V GFCI outlet.
- 2) If the GFCI has been tripped, press the 'RESET' button to restore power.
- 3) Set the power switch to 'ON' to inflate.
- 4) To disconnect, grip it tightly and pull the plug from the wall outlet. It is recommended to be done by an adult.



**WARNING: Failure to follow these instructions could result in serious injury or death.**

- ADULT SETUP AND SUPERVISION REQUIRED.
- Use only with Ground Fault Circuit Interrupt (GFCI) receptacle.
- This blower is for residential use only. It is not intended to be used in commercial or industrial settings.
- Do not use with a damaged cord or plug.
- Do not use near explosive or flammable materials.
- Never connect the blower to any solid state speed control device - this could cause a safety hazard.
- **WARNING!** Electrocutation Hazard - Do not use extension cords with this product.
- Always unplug before maintenance.
- Outdoor use only.

### Instructions For Blower Cleaning And Storage

Do not immerse the blower in water. Unplug before cleaning. Wipe with a damp cloth to clean. The blower does not require any lubrication and has no user serviceable parts. Do not attempt to service the blower. When not in use, store in a dry place indoors. Store upright on a stable surface. Loosely coil the cord and place it beside the blower.

## Safety Warnings: SET UP

ADULT SUPERVISION AND SETUP REQUIRED. This product should be setup by an adult. Follow all instructions provided.

WARNING! Falling onto hard surfaces can result in head or other serious injuries. Never place on concrete, asphalt, wood, packed earth, grass or other hard surfaces. Carpet may not prevent injury.

- WARNING! Intended for outdoor domestic use only. Not to be used in public areas or as a rental.
- Product is heavy. Be cautious when lifting.
- Do not drag this product across concrete, pavement or other rough surfaces.
- WARNING! Keep fabric clear of flame and ignition sources.
- Do not set up in windy or rainy conditions. Sudden gust of wind could lift the product off the ground.
- Product can be installed under the sun, since there are no metal components or surfaces that can absorb excessive solar radiation.
- Only setup if the product meets the following criteria:
  - Place on an even surface and remove grass or soil to allow proper use of stakes.
  - Placing on slanted or uneven surfaces may cause the product to tip.
- Stakes should be placed vertically for better anchorage. They should be driven under the ground to prevent tripping.
- Keep a space of 6.6ft (2m) around the product free. Keep away from fences, buildings, trees, overhead branches, laundry lines, electrical wires, walls etc.
- Ensure the area around the product is secure with barriers to keep young children and pets from entering unattended.
- Do not place the electrical cord under the inflatable.
- The bouncer uses a main powered blower (air pump) to maintain pressure, only to be used by an adult.
- Only use the provided blower for setting up.
- Do not use extension cords with this product. Set up as close to power sources as possible. Ensure the product is securely anchored to the ground before use.
- CAUTION: The blower can move large volumes of air quickly. Place in an area where it will not suck in dirt or leaves. Keep the blower and power cord away from children.
- ATTENTION: The blower should remain on to keep the bouncer inflated during use. Airflow through the seams is normal. Do not try to seal or repair seams.
- Do not use if the wind is higher than 20mph.
- Keep the power cord away from water.

# Safety Warnings: Failure to Follow these Instructions Could Result in Serious Injury Or Death.



Maximum individual height: 3.9 feet (120 cm)



Total weight limit: 264 lbs (120 kg)



Individual weight limit: 66 lbs (30 kg)



No sharp objects



Do not slide head first.



Age



No wrestling.



Adult supervision required. Do not leave children unattended.



Maximum number of children: 4



No flipping



No shoes, no glasses



No hands or feet on net.



Do not use in windy conditions.



Do not leave out in rain.



Do not allow children to touch fan or electrical cord.



Must be anchored using stakes.

**Adult supervision of children and other young users is required at all times. Supervision should be at the front, where all play areas can be seen.**

- Keep the area around the product clean and clear of objects, to prevent slips and falls.
- Do not use until it is fully inflated.
- This is not an aquatic product. Do not use in water.
- Instruct children on proper use of this product:
  - Children should not wear loose or baggy clothing, scarves, hoods or clothing with drawstrings when using.
  - Children must remove helmets, loose clothing, scarves, headgear, shoes and glasses. Remove any sharp or hard objects from their pockets, as it could puncture the surface.
  - Toys and other objects should never be allowed inside the bouncer.
  - Do not attach any items to the product that are not designed for use, such as jump ropes, clothesline, pet leashes, cables and chains - they could cause a strangulation hazard.
  - Keep pets away from this product.
  - Children should bounce away from others and stay away from openings and walls.
  - Separation of larger children from smaller children.
- Children should not jump onto or off the product.
- Do not allow users to climb or hang on the walls.
- Do not allow users to do somersaults or rough play.
- Do not allow food, drink or gum inside the unit.
- Total weight of children must not exceed 264 lbs (120 kg). No more than two children should play on the Dunk 'n Toss Bouncer™ at the same time.
- Children must not slide down head first.
  - Before and during use, check for air loss. Ensure the blower is properly connected.
  - Always check the product and its anchorage points before and during use. Ensure they are secure.
  - If possible, remove water and debris from pocket steps after each use.
  - After inflation, the blower should run continuously.
  - Ensure no one is on the product when deflating.
  - To be used on impact absorbing material (eg. Rubber mulch, engineered wood fibre, etc). Keep this product at a minimum distance of 2m (6.6ft) from all other objects.
  - The Critical Fall Height of this product is 40 inches (101.6cm).
  - Do not attempt to make any modifications to this product.
- Clean the step pockets and remove debris after each play cycle.

# Minimum Clearance Zones

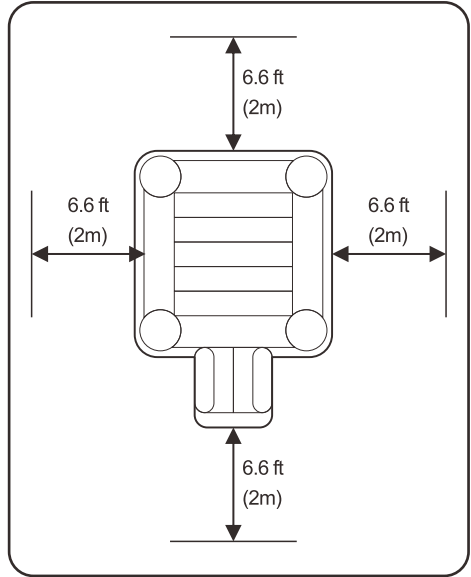
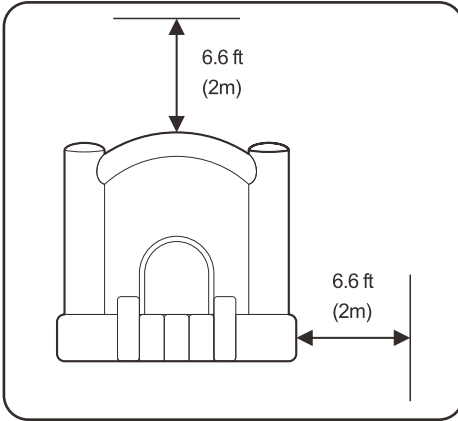

## MINIMUM CLEARANCE ZONES

### INFLATABLE SIZE:

Keep this product at a minimum distance of 2m (6.6ft) from all other objects, including the slide and overhead.

## BLOWER CAUTIONS

 **CAUTION:** Read all signs and warning labels on the motor.

- Do not open or try to service the blower. If servicing is needed, contact a qualified serviceman.
- Clearly mark the path of the power cord to avoid tripping or damage.
- Never leave unattended.
- Children must not use or play with the blower.
- Do not cover the air intakes when the blower is being used and do not insert small objects into any part of the blower.
- **WARNING! Electrocutation Hazard: DO NOT USE EXTENSION CORDS WITH THIS PRODUCT.**
- Unplug from the power source when moving the slide.
- **WARNING -** To reduce the risk of a fire or electric shock, do not use with any solid state speed control device.
- The blower should be securely staked to the ground before use.





# Setup

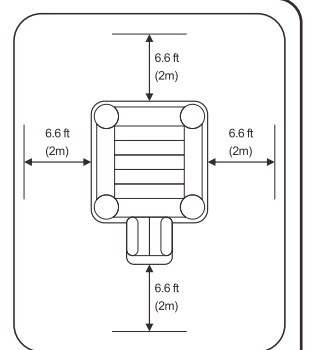
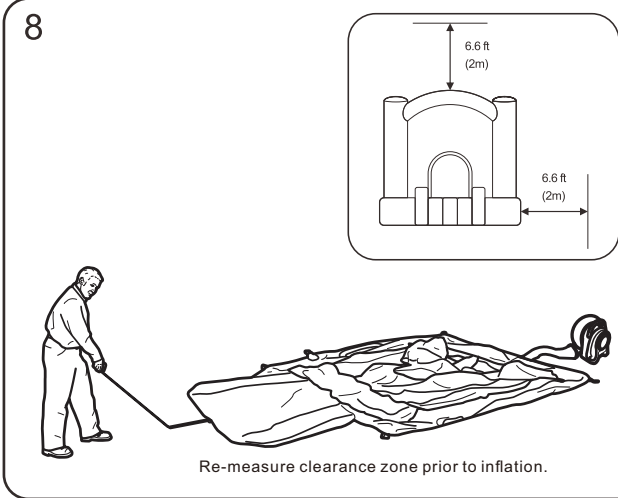
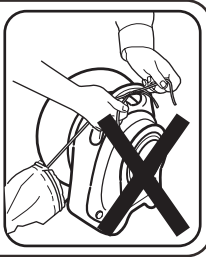
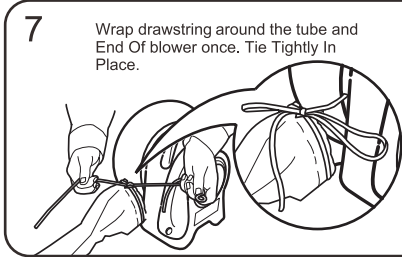
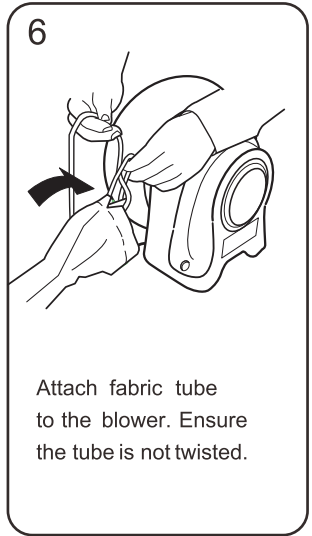
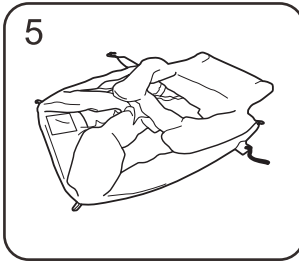
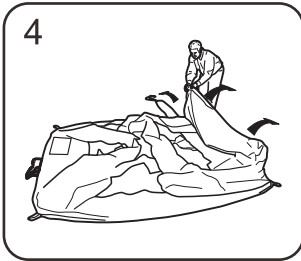
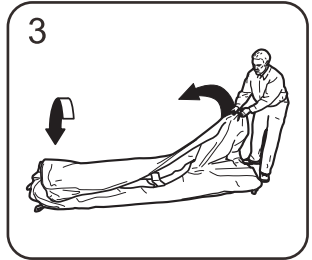
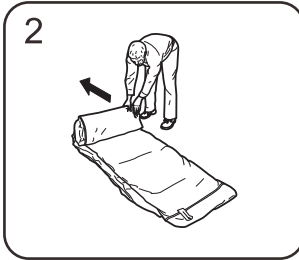
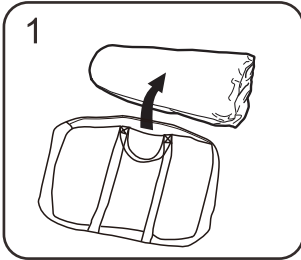

# Inflation & Staking

1

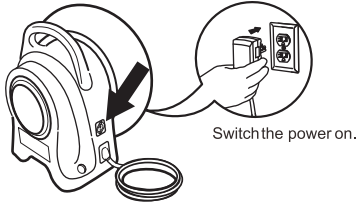

2

The blower should remain on to keep the bouncer inflated. Airflow through the seams is normal. Do not try to seal or repair the seams.

NOTE: Dispose of tissue paper packed inside the bouncer after inflation.

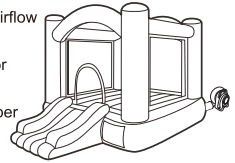

3

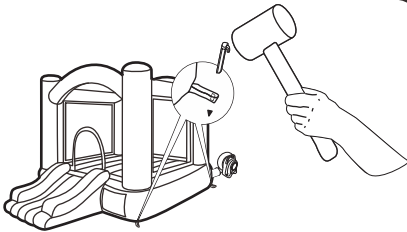

4

Secure the blower to the ground with the stakes provided.

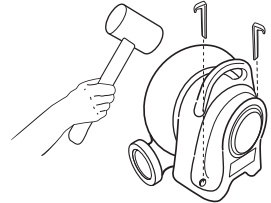

# Deflation & Storage

1

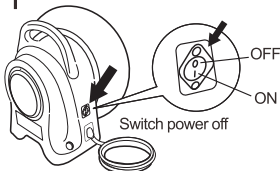

Turn off the blower and unplug it from the outlet.

2

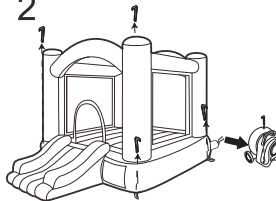

3

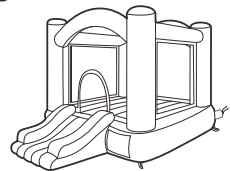

Untie drawstring from the intake.

4



5

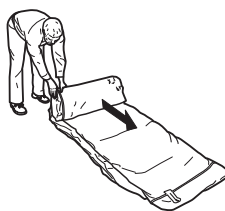

6

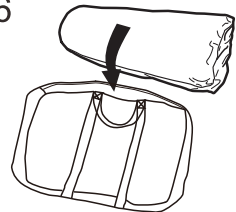

# Care And maintenance

## Repair Kit Instructions



### WARNING

NOT A TOY. ADULT USE ONLY.  
Repair kit. Keep away from children.

**WARNING: Repair patches must be applied by an adult.**

**KEEP OUT OF REACH OF CHILDREN. REPAIR PATCH**

### INSTRUCTIONS

1. Deflate the item, clean the area and allow to dry thoroughly.
2. Cut a portion of the patch to the size needed (see Fig.1 & 2).
3. Remove the adhesive backing from the patch material, position the patch over the damaged area and smooth out any bubbles.
4. Wait 30 minutes before inflating.

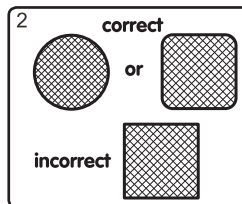
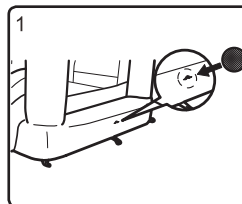

## Instructions for Bouncer Maintenance

- As an outdoor product, the bouncer is subject to wear and deterioration. Inspect for signs of fabric failure. Weak or torn surfaces must be repaired promptly.
- To keep the product clean, wipe using a dry or dampened cloth. Use a neutral, non-inflammatory, non-toxic cleaning solution or pure water. Do not store the product when wet. Let it dry before rolling it up.

## Instructions for Blower Maintenance

- Unplug the blower before servicing. This Product should be occasionally examined for a damaged cord, plug, housing, or parts. If damage is found, do not use until properly repaired. If these checks are not carried out, the product could become a safety hazard.
- The blower does not require any lubrication and has no user serviceable parts. Do not attempt to service the blower.
- Do not immerse the fan in water. Wipe with a damp cloth to clean.
- Regularly check the intake and output openings and keep free of dirt, leaves, etc.
- When not in use, store the blower indoors, in a dry place.
- Store the blower upright on a stable surface.
- Loosely coil the cord and place it beside the blower.
- When in use, do not place the cord across congested, water or damp areas.
- This is a high volume blower, which can move large volumes of air quickly. Place the blower in an area where it will not suck in dirt or leaves.

## Disposal

- Disassemble and dispose of the equipment in such a safe manner to prevent potential hazards.
- The product must be returned to a collection centre capable of processing electrical/electronic waste.

**US**

If you have any questions, please contact our customer care center.  
Our contact details are below:



001-877-644-9366



customerservice@aosom.com

Imported by Aosom LLC  
27150 SW Kinsman Rd Wilsonville, OR 97070 USA  
MADE IN CHINA

**CA**

If you have any questions, please contact our customer care center.  
Our contact details are below:

Si vous avez la moindre question, veuillez contacter notre centre d'assistance à la clientèle.  
Nos coordonnées sont les suivantes:



416-792-6088



customerservice@aosom.ca

Imported by Aosom Canada Inc.  
1251 Tapscott Road, Unit 101, Scarborough, Ontario Canada M1X 1S9  
MADE IN CHINA

Importé par Aosom Canada Inc.  
1251 Rue Tapscott, Unité 101, Scarborough, Ontario Canada M1X 1S9  
FABRIQUÉ EN CHINE