

Tools Recommended

EN_IMPORTANT, RETAIN FOR FUTURE REFERENCE: READ CAREFULLY.

FR_IMPORTANT: A LIRE ATTENTIVEMENT ET À CONSERVER POUR CONSULTATION ULTÉRIEURE.

ES_IMPORTANTE, LEA Y GUARDE PARA FUTURAS REFERENCIAS.

PT_IMPORTANTE, RETER PARA REFERÊNCIA FUTURA: LEIA ATENTAMENTE.

DE_WICHTIG! SORGFÄLTIG LESEN UND FÜR SPÄTER NACHSCHLAGEN AUFBEWAHREN.

IT_IMPORTANTE! CONSERVARE IL PRESENTE MANUALE PER FUTURO RIFERIMENTO E LEGGERLO ATTENTAMENTE.

PARTS

1 x 8

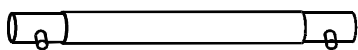

2 x 8



3 x 8

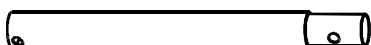

4 x 5

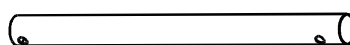

5 x 5

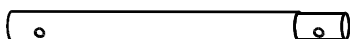

6 x 5

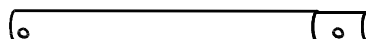

7 x 2

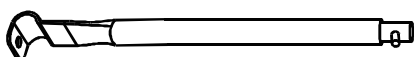

8 x 2

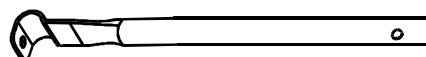

10 x 4



12 x 4

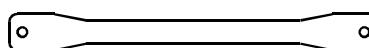

HARDWARE

H x20
M6*45
+1(spare)

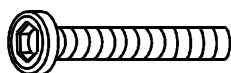

K x20
+1(spare)



A x10
+1(spare)



B x 4



C x 4



D x 1



- 1 x4
- 2 x4
- 5 x1
- 6 x1
- 10 x2
- A x1
- H x2
- K x2

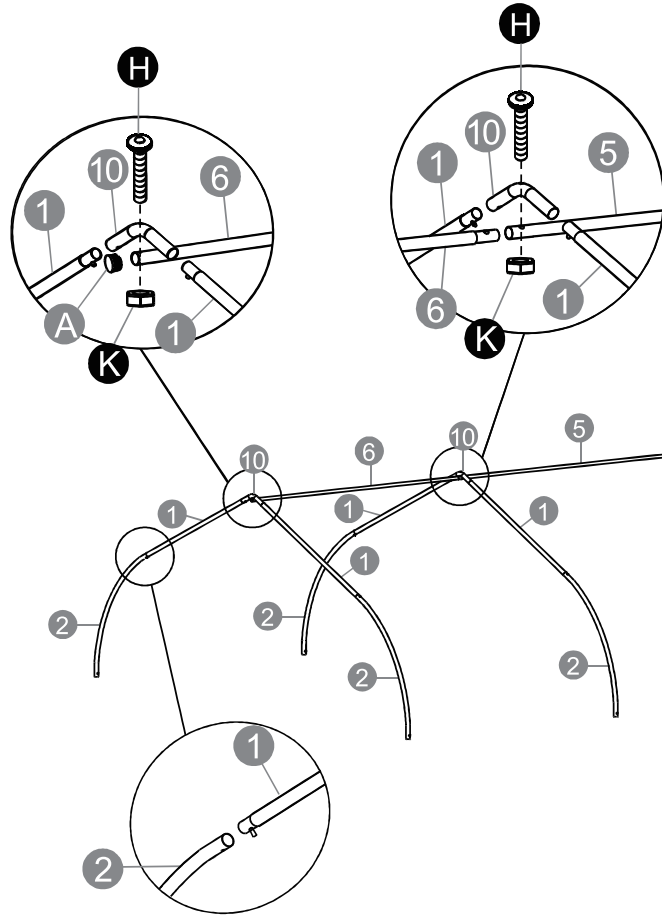

- 3 x4
- 5 x4
- 6 x4
- 7 x1
- 8 x1
- 12 x2
- A x4
- H x8
- K x8

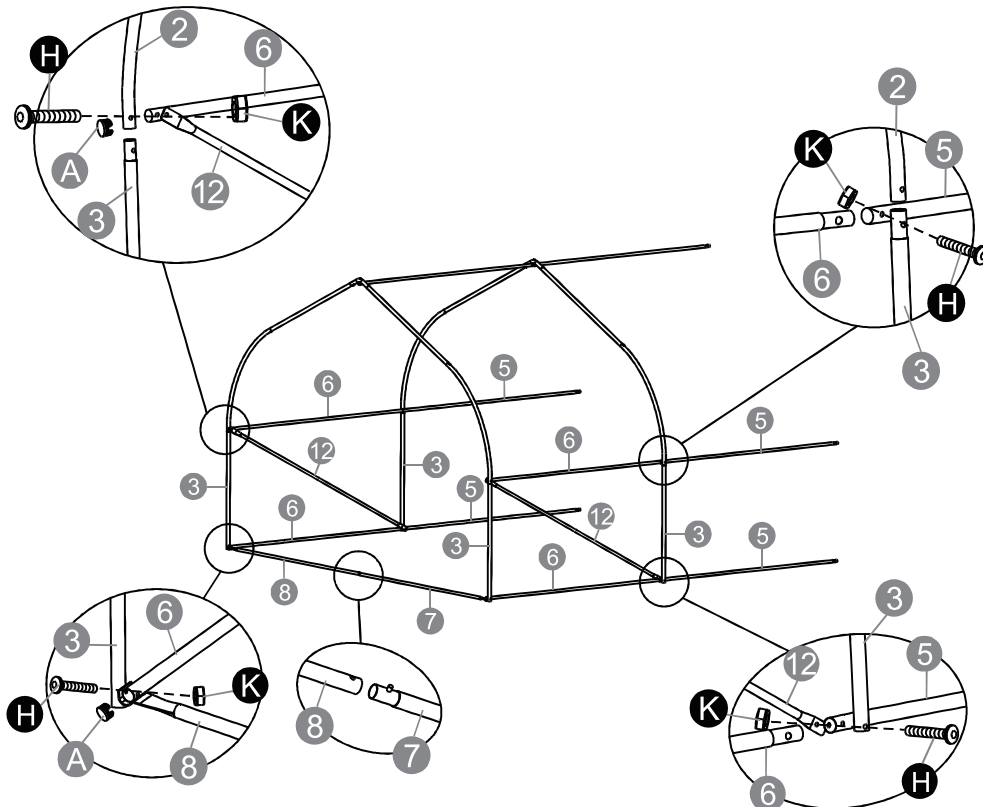

- 1 x2
- 2 x2
- 3 x2
- 4 x5
- 10 x1
- 12 x2
- H x5
- K x5

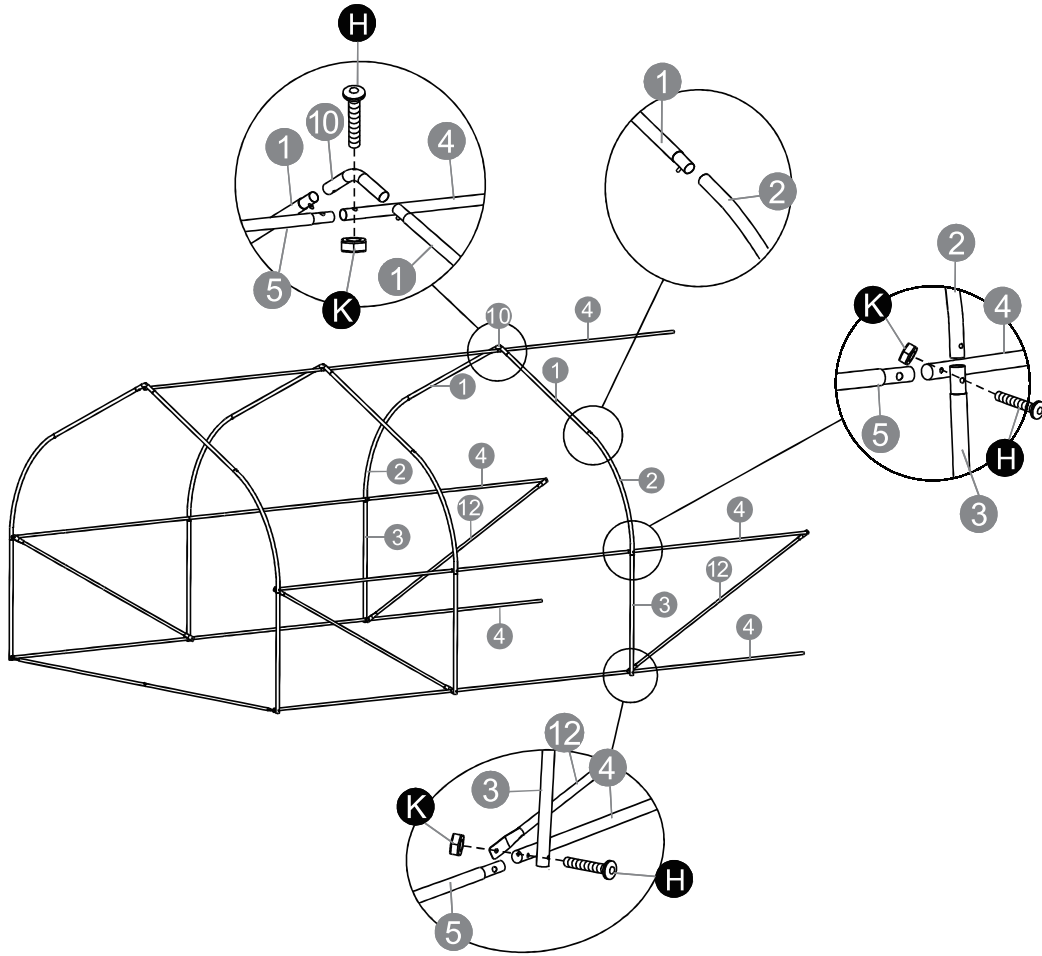

- 1 x2
- 2 x2
- 3 x2
- 7 x1
- 8 x1
- 10 x1
- A x5
- H x5
- K x5

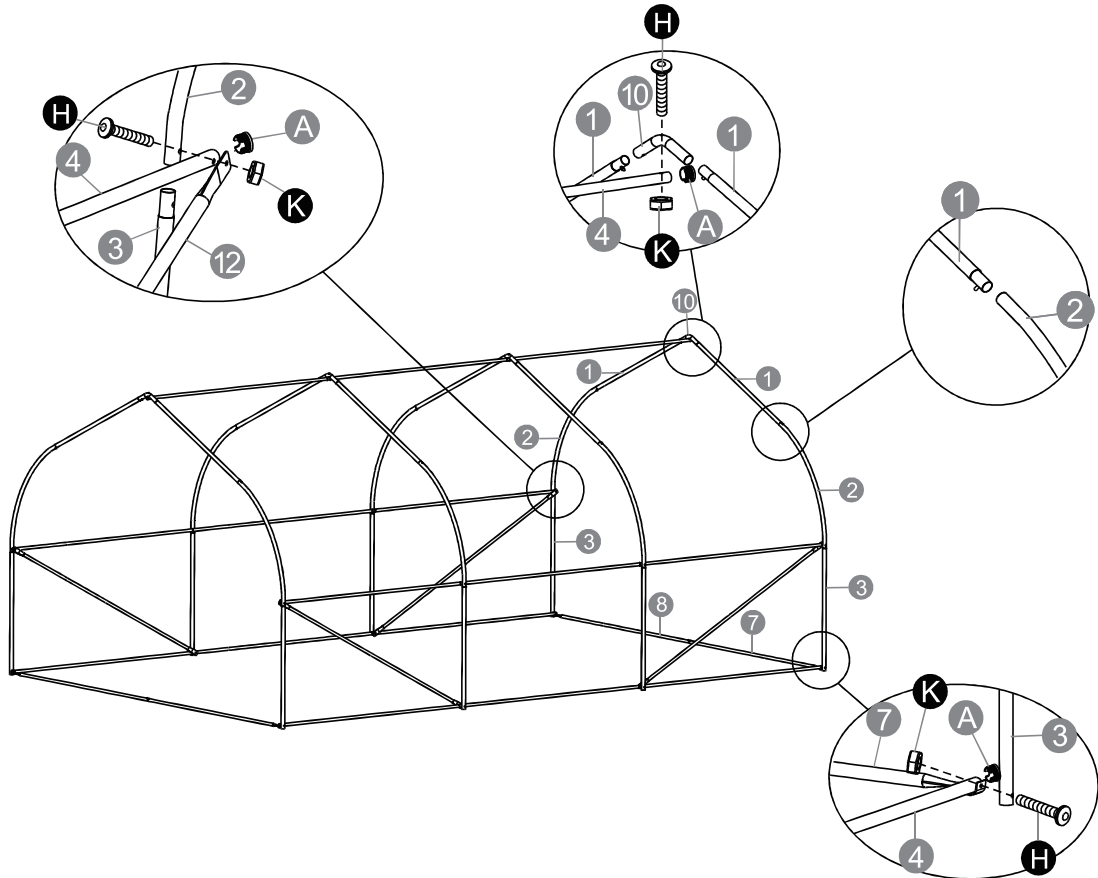

B x4
C x4
D x1

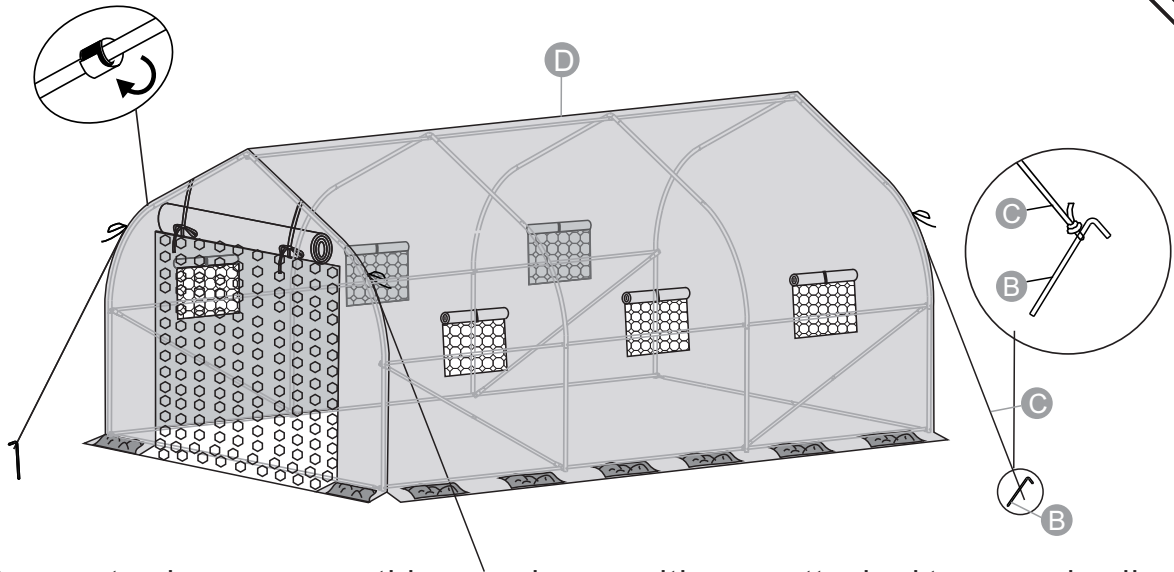

EN Be sure to always secure this greenhouse with rope attached to ground nail when in use

FR Assurez-vous toujours de sécuriser cette serre avec une corde attachée à un piquet de sol lorsque vous l'utilisez.

ES Asegúrese de atar las cuerdas a los clavos de tierra para fijar este invernadero cuando esté en uso.

PT Durante o uso, por favor, não se esqueça de prender a estufa amarrando a corda a uma estaca no chão.

DE Bitte befestigen Sie das Seil bei der Verwendung des Gewächshauses an den Heringen, um es zu fixieren.

IT Per garantire la sicurezza durante l'uso, fissare sempre la serra al terreno utilizzando una corda agganciata ad un picchetto infisso nel terreno.

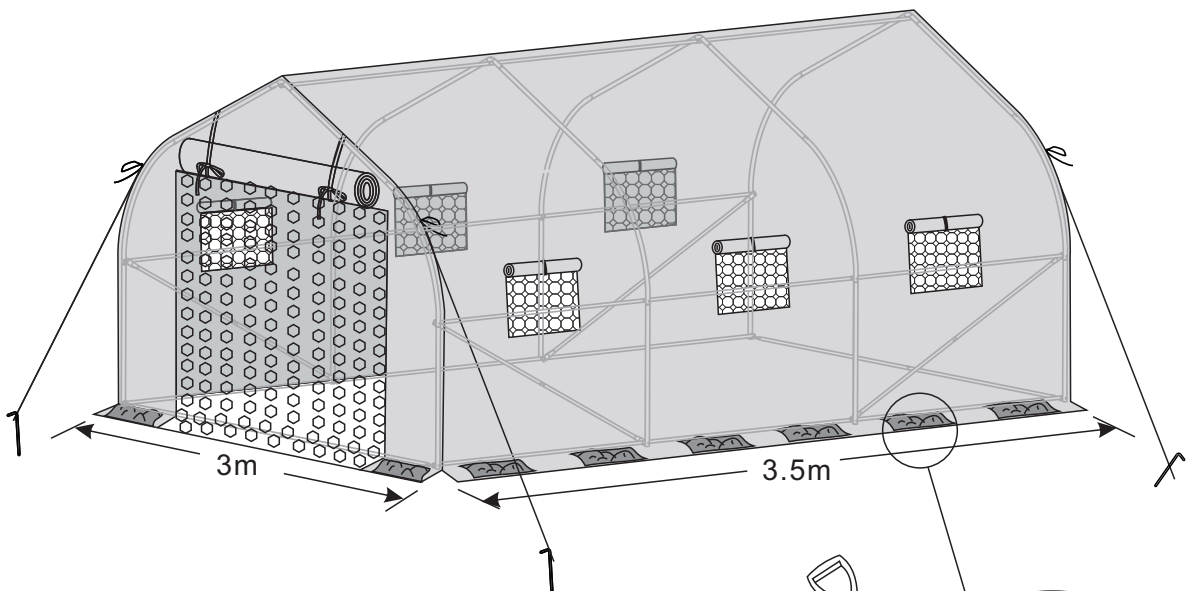

EN Press the soil on the edge of the soil around the greenhouse.

FR Tasser la terre sur le bord du sol autour de la serre.

ES Presione el suelo en el borde de tierra alrededor del invernadero.

PT Pressionar o solo na borda do solo em redor da estufa.

DE Drücken Sie die Erde am Rand des Bodens um das Gewächshaus herum an.

IT Premere il terreno sul bordo attorno alla serra.

If you have any questions, please contact our customer care center. Our contact details are below:

 001-877-644-9366

 customerservice@aosom.com

Imported by Aosom LLC
27150 SW Kinsman Rd Wilsonville, OR 97070 USA
MADE IN CHINA

US

Si tiene alguna pregunta, comuníquese con nuestro Centro de Atención al Cliente. Nuestros datos de contacto son los siguientes:

 0034-931294512

 atencioncliente@aosom.es

IMPORTADOR:
SPANISH AOSOM, S.L.
C/ ROC GROS, Nº 15. 08550, ELS HOSTALETES DE BALENYÀ, SPAIN.
B66295775
WWW.AOSOM.ES
HECHO EN CHINA

ES

If you have any questions, please contact our customer care center. Our contact details are below:

 416-792-6088

 customerservice@aosom.ca

Imported by Aosom Canada Inc.
7270 Woodbine Avenue, Unit 307, Markham, Ontario Canada L3R 4B9
MADE IN CHINA

CA

Se tiver alguma dúvida, por favor contacte o nosso Centro de Atendimento ao Cliente. Os nossos dados de contacto são os seguintes:

 0034-931294512 (SEG-SEX DAS 7:30H ÀS 16:30H)

 info@aosom.pt.

IMPORTADOR:
SPANISH AOSOM, S.L
C.ROC GROS N.15, 08550. ELS HOSTALETES DE BALENYÀ
WWW.AOSOM.PT

PT

Si vous avez la moindre question, veuillez contacter notre centre d'assistance à la clientèle. Nos coordonnées sont les suivantes:

 416-792-6088

 customerservice@aosom.ca

Importé par Aosom Canada Inc.
7270 Woodbine Avenue, unité 307, Markham, Ontario Canada L3R 4B9
Fabriqué en Chine

Wenn Sie Fragen haben, wenden Sie sich bitte an unser Kundendienstzentrum. Unsere Kontaktdaten stehen unten:

 0049-0(40)-88307530  service@aosom.de

ADRESSE DES IMPORTEURS:
MH Handel GmbH
Wendenstraße 309
D-20537 Hamburg
Germany
IN CHINA HERGESTELLT

DE

If you have any questions, please contact our customer care center. Our contact details are below:



 0044-800-240-4004

 enquiries@mhstar.co.uk

IMPORTER ADDRESS:
MH STAR UK LTD
Unit 27, Perivale Park,
Horsenden lane South
Perivale, UB6 7RH
MADE IN CHINA



UK

In caso di dubbio, si prega di contattare il nostro centro assistenza clienti. I nostri dettagli di contatto sono di seguito:

 0039-0249471447  clienti@aosom.it

IMPORTATO DA:
AOSOM Italy srl
Centro Direzionale Milanofiori
Strada 1 Palazzo F1
20057 Assago (MI)
P.I.: 08567220960
FATTO IN CINA

IT

Si vous avez la moindre question, veuillez contacter notre centre d'assistance à la clientèle. Nos coordonnées sont les suivantes:  0033-1-84166106  aosom@mhfrance.fr

Importé par: MH France 2, rue Maurice Hartmann 92130 Issy-les-Moulineaux
Fabriqué en Chine
France

FR



Adresses sur quefairedemesdechets.fr