

# ESCALERA MULTIPROPÓSITO

**ES**

## Instrucciones de seguridad

- > Para garantizar su seguridad, lea cuidadosamente este manual de instrucciones.
- > Este manual debe ser guardado bien para referencia futura.





IMPORTANTE - CONSERVE ESTA INFORMACIÓN  
PARA SU CONSULTA POSTERIOR: LEER DETALLADAMENTE

# MANUAL DE INSTRUCCIONES

**Queridos clientes,**

Gracias por comprar este producto. Para que su electrodoméstico le sirva mejor, lea todas las instrucciones de este manual del usuario. Si tiene alguna pregunta, comuníquese con nuestro Centro de Atención al Cliente.

**ES\_ Nuestros datos de contacto son los siguientes:**

<b>País</b>	 <b>Teléfono</b>	 <b>Correo electrónico</b>
ES&PT	0034-931294512	atencioncliente@aosom.es

**IMPORTADOR:**

*Spanish Aosom, S.L.  
C/ Roc Gros, nº 15.  
08550, Els Hostalets de Balenyà, Spain.  
B66295775  
www.aosom.es  
atencioncliente@aosom.es  
TEL: 931294512*

*HECHO EN CHINA*

**IMPORTANTE :** Los estabilizadores deben ser instalados antes del uso.

### Instrucciones de montaje

1. Coloque la barra estabilizadora en el extremo de rieles laterales (como lo que se muestra en el diagrama).
2. Asegurese de que la barra estabilizadora se fije con la tuerca y el perno.

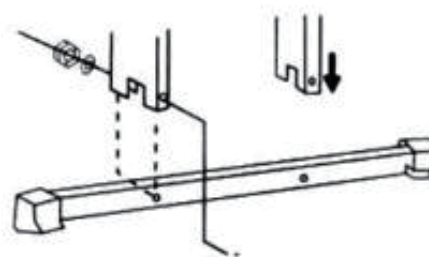

### Cuidado y mantenimiento

1. Las bisagras deben ser lubricadas con lubricante de buena calidad para garantizar la movilidad.
2. Las bisagras deben ser limpiadas después de su uso, especialmente cuando las bisagras han sido expuestas a polvo o suciedad.
3. Limpie el área o lave con agua tibia. Sin embargo, si se utiliza agua en las bisagras, recuerde volver a lubricar después del secado.

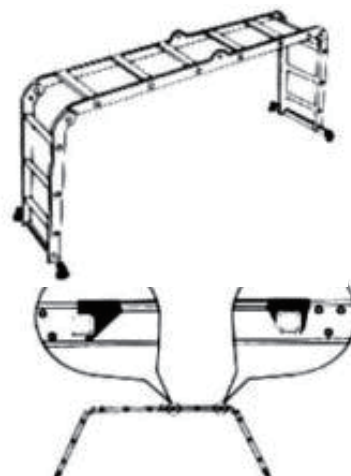

**Importante:** Esta escalera nunca debe ser usada si falta alguna pieza, está dañada o desgastada.

Seguir las instrucciones anteriores ayudará a mantener su electrodoméstico y garantizar su vida útil máxima.

### Bisagras

1. Para desbloquear las bisagras, simplemente mueva la manija a la posición de desbloqueo "o" (vea el diagrama) y luego doble la sección de la escalera hacia adentro.
2. Las bisagras se bloquearán en forma automática en su posición una vez que se despliegue la escalera.
3. Siempre verifique que todas las bisagras estén fijadas en su posición antes de usar la escalera.
4. Cada par de bisagras debe ser bloqueada simultáneamente.
5. Es extremadamente peligroso intentar cambiar la posición de la escalera, las bisagras o las juntas de operación mientras la escalera está en uso.
6. Mantenga siempre las juntas limpias y libres de materiales extraños, es recomendable cubrirlas durante trabajos excepcionalmente desordenados.

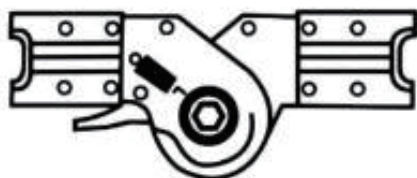

L-BLOQUEO  
O-DESBLOQUEO

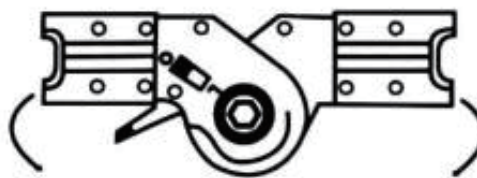

LAS BISAGRAS SE BLOQUEARÁN  
FIRMEMENTE EN SU LUGAR

## PRECAUCIÓN

Para abrir la sección de escalera:

Coloque el pasador de bloqueo (negro) en la posición "O".

La bisagra está bloqueada cuando está en la posición "L".

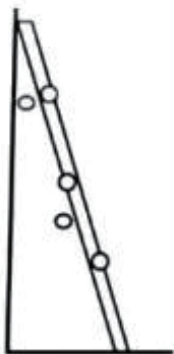
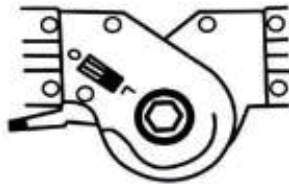

ESCALERA  
RECTA

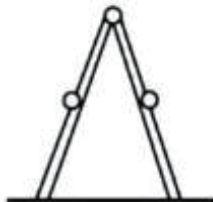

ESCALERA  
DE PASO

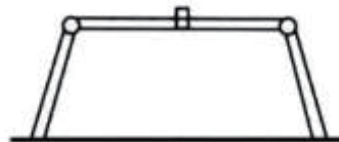

ANDAMIO

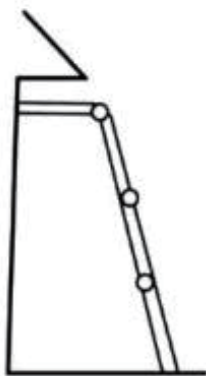

ESCALERA  
SUPERIOR

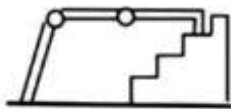

ANDAMIO  
DE  
ESCALERA

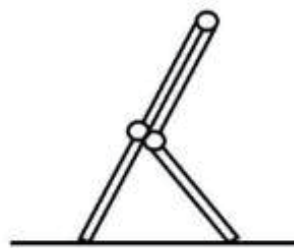

HERRINGBONE

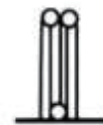

ALMACENAMIENTO

## INSTRUCCIONES DE SEGURIDAD

- Esta escalera solo puede ser usada en las posiciones que se muestran arriba.
- Debe prestar atención en todo momento al usar la escalera.
- Siempre verifique la estabilidad de la escalera asegurándose de que esté colocada en terreno nivelado y sólido.
- Siempre verifique que todas las bisagras estén en las posiciones correctas para su uso particular.
- Establezca en el ángulo adecuado (75.5 grados) en posición recta.

Esta escalera multifuncional está equipada con 2 paneles de hierro para una mejor función del andamio o la escalera de la plataforma, y hay 2 paneles de diferentes longitudes con extremos curvos y 2 ganchos para agregar estabilidad y seguridad al usarla.

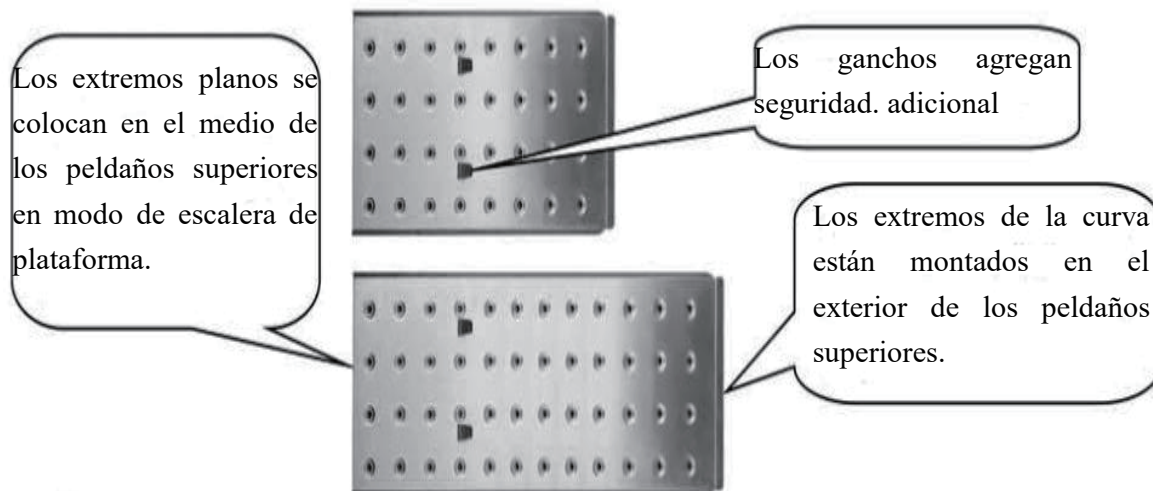

## Instrucciones:

1. Configure la escalera como un andamio o una escalera de plataforma.



2. Coloque los 2 paneles sobre los peldaños superiores con sus extremos planos colocados en el medio y sostenidos por al menos medio peldaño.



3. Monte los extremos curvos en la parte más externa de los peldaños superiores y asegúrese de que los paneles sean antideslizantes y puedan bloquear los ganchos con los peldaños.

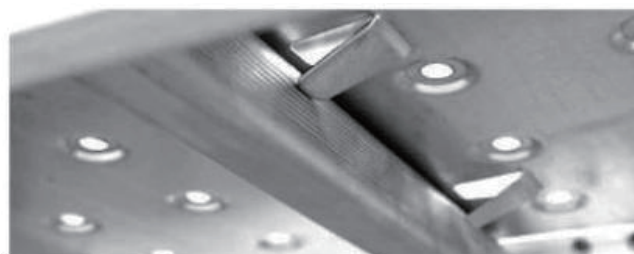

## SCALA MULTIUSO

**IT**

### Istruzioni di Sicurezza

>Per garantire la vostra sicurezza, leggete attentamente questo manuale di istruzioni.

>Il presente manuale deve essere conservato per riferimenti futuri.





**IMPORTANTE - CONSERVARE QUESTE INFORMAZIONI  
PER CONSULTARLE IN SEGUITO: LEGGERE ATTENTAMENTE**

# MANUALE D'USO

**Caro Cliente,**

Grazie per aver acquistato questo prodotto. Per servirti meglio con questo apparecchio ti prego di leggere tutte le istruzioni in presente manuale utente. In caso di dubbio, si prega di contattare il nostro centro assistenza clienti.

**I nostri dettagli di contatto sono di seguito:**

Country	 Telefono	 Email
IT	0039-0249471447	clienti@aosom.it

**IMPORTATO DA:**

*AOSOM Italy srl  
Centro Direzionale Milanofiori  
Strada 1 Palazzo F1  
20057 Assago (MI)  
P.I.: 08567220960*

*FATTO IN CINA*

**IMPORTANTE:** Gli stabilizzatori devono essere montati prima dell'uso

### Istruzioni di ssemblaggio

1. Posizionare la barra stabilizzatrice all'estremità dei supporti laterali (vedi figura).
2. Fissare la barra stabilizzatrice con i dadi e i bulloni.

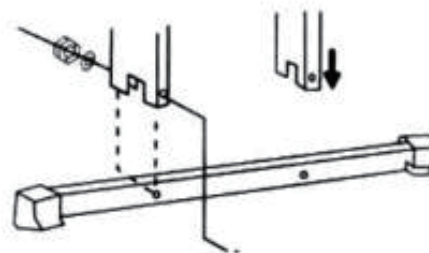

### Cura & manutenzione

1. Le cerniere devono essere lubrificate con un lubrificante di buona qualità per garantire la mobilità.
2. Le cerniere devono essere pulite dopo l'uso, soprattutto quando le cerniere sono state soggette a polvere o sporco.
3. Pulire l'area o lavare con acqua tiepida. Tuttavia, se le cerniere sono state bagnate dall'acqua, ricordarsi di lubrificare nuovamente dopo l'asciugatura.

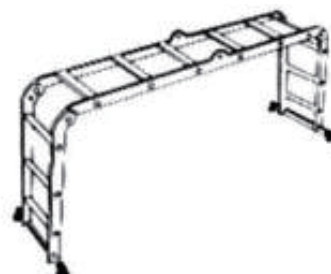

**Importante!** Questa scala non deve mai essere utilizzata se qualche parte è mancante, danneggiata o usurata.

Seguire le istruzioni di cui sopra aiuterà a mantenere l'attrezzatura e garantirne la massima durata.

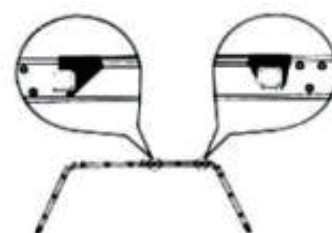

### Cerniere

1. Per sbloccare le cerniere basta spostare la maniglia nella posizione di sblocco "O" (vedi figura) e poi piegare la sezione della scala verso l'interno.
2. Le cerniere si bloccheranno automaticamente in posizione una volta aperta la scala.
3. Verificare sempre che tutti le cerniere siano saldamente bloccate in posizione prima di utilizzare la scala.
4. Ogni coppia di cerniere deve essere bloccata contemporaneamente.
5. È estremamente pericoloso tentare di alterare il posizionamento della scala, delle cerniere o dei giunti di manovra mentre la scala è in uso.
6. Mantenere i giunti sempre puliti e privi di qualsiasi materiale estraneo, si consiglia di coprire i giunti durante lavori eccezionalmente sporchi.

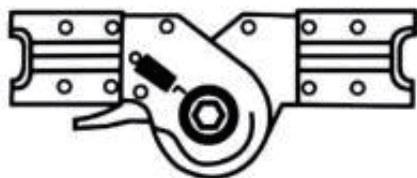

**BLOCCO - L  
SBLOCCO - O**

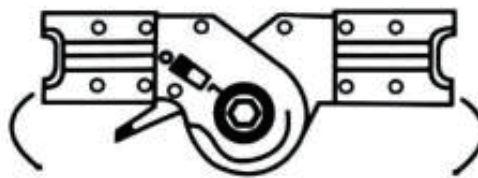

**LE CERNIERE SI BLOCCANO  
SALDAMENTE IN POSIZIONE**



## ATTENZIONE

Per aprire la sezione della scala:

Posizionare il perno di bloccaggio (nero) in posizione "O".

La cerniera è bloccata quando è in posizione "L".

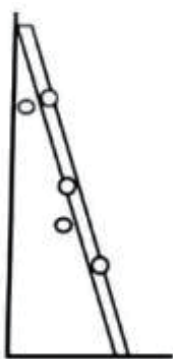

SCALA DA  
APPOGGIO

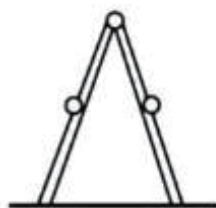

SCALA A  
COMPASSO

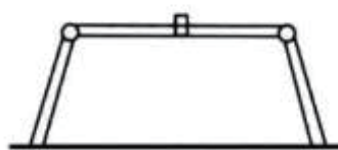

PIANO DI LAVORO

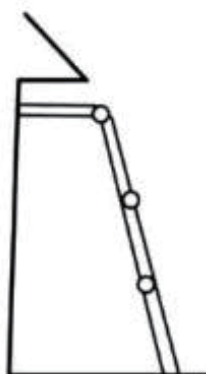

SCALA A  
SOSPENSIONE

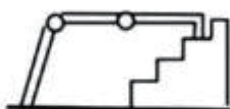

PIANO DI LAVORO  
PER VANO SCALA

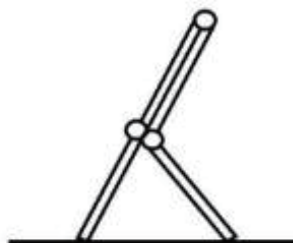

SCALA A SPINA  
DI PESCE

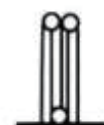

CHIUSURA PER  
STOCCAGGIO

## ISTRUZIONI DI SICUREZZA

- Questa scala può essere utilizzata solo nelle posizioni sopra indicate.
- Prestare sempre la dovuta cura e attenzione quando si utilizza la scala.
- Controllare sempre la stabilità della scala assicurandosi che sia posizionata su un terreno piano e solido.
- Verificare sempre che tutte le cerniere siano nelle posizioni corrette per il proprio uso particolare.
- Impostare l'angolo corretto (75,5 gradi) in posizione diritta.

Questa scala multifunzionale è dotata di 2 pannelli in ferro per stare meglio sul piano di lavoro o sulla scala a piattaforma, e ci sono 2 pannelli di diverse lunghezze con estremità curva e 2 ganci per aggiungere stabilità e sicurezza durante l'utilizzo.

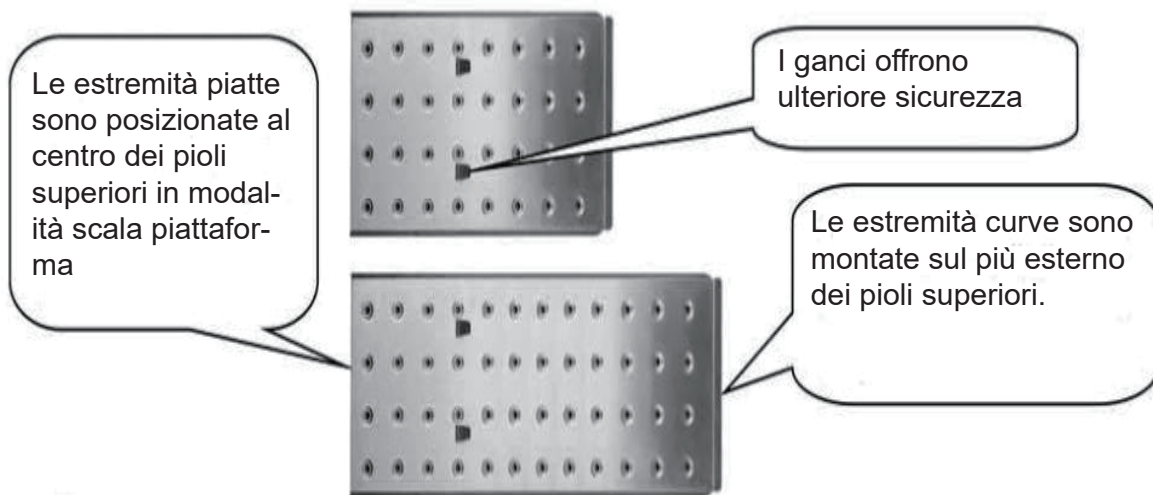

### Istruzioni:

1. Configurare la scala come piano di lavoro o scala a piattaforma.



2. Posizionare i 2 pannelli sopra i pioli superiori, con le estremità piatte poste al centro e sostenute da almeno mezzo piolo.

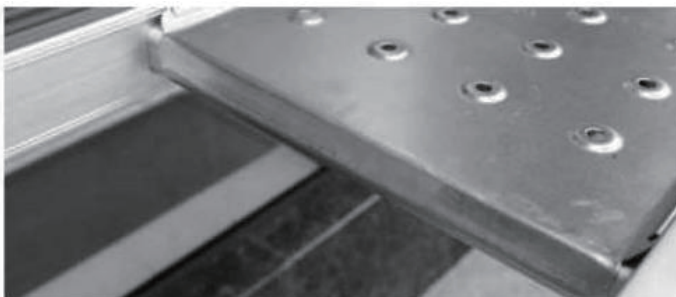

3. Montare le estremità curve sulla parte più esterna dei pioli superiori e assicurarsi che i pannelli siano antiscivolo bloccando i ganci con i pioli.

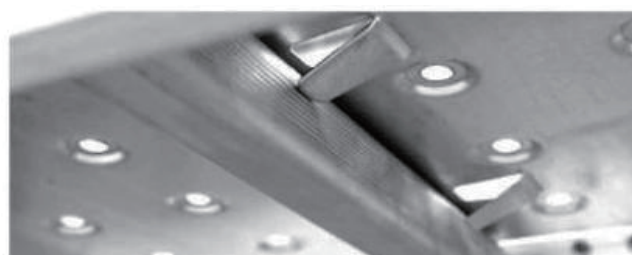

**MULTI-PURPOSE LADDER****EN****Safety Instructions**

- To ensure your safety please read this instruction manual carefully.
- This manual should kept for future reference.



IMPORTANT, RETAIN FOR FUTURE REFERENCE: READ CAREFULLY

**INSTRUCTION MANUAL**

# **IMPORTANT** : Stabilizers must be fitted before use

## **Assembly Instructions**

1. Place the stabilizer bar into the end of the side rails (see diagram).
2. Secure the stabilizer bar with the nut and bolt.

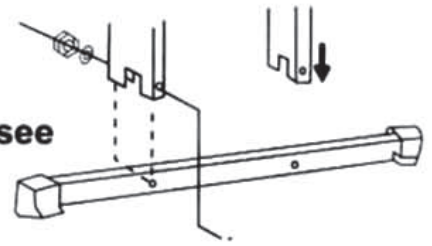

## **Care & Maintenance**

1. The hinges should be lubricated with a good quality lubricant to ensure mobility.
2. The hinges should be cleaned after use especially when the hinges have been subjected to dust or dirt.
3. Clean the area, or wash with warm water. However should water be used on the hinges, please remember to re-lubricate after drying.



**Important:** This ladder should never be used if any part is missing, damaged or worn.

Following the above instructions will help to maintain your appliance and ensure its maximum lifespan.

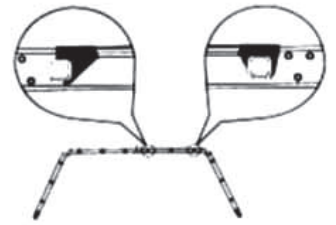

## **Hinges**

1. To unlock the hinges simply move the handle to the "o" unlock position (see diagram) and then fold the ladder section inward.
2. The hinges will automatically lock into position once the ladder is unfolded.
3. Always check that all hinges are securely locked into position before using the ladder.
4. Each pair of hinges must be locked simultaneously.
5. It is extremely dangerous to attempt to alter the positioning of the ladder, hinges or operating joints while the ladder is in use.
6. Always keep the joints clean and free from all foreign materials, it is advisable to cover the joints during exceptionally messy jobs.



L-LOCK  
O-UNLOCK

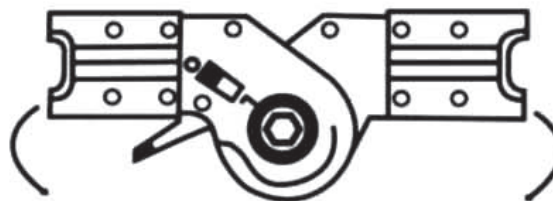

HINGES WILL LOCK  
FIRMLY IN PLACE

## CAUTION

To open the ladder section:  
Place the locking pin (black) to the "O" position.  
The hinge is locked when in the "L" position.

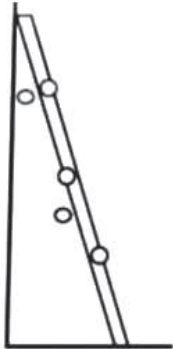
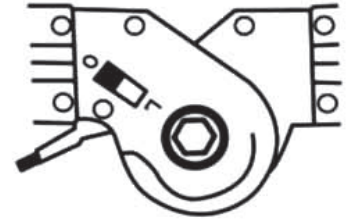
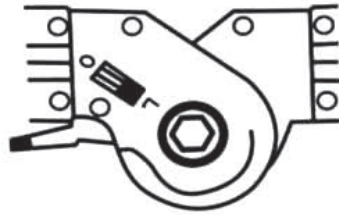

STRAIGHT  
LADDER

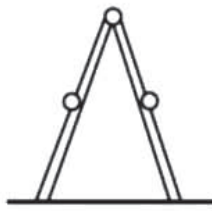

STEP  
LADDER

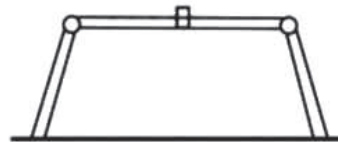

SCAFFOLD

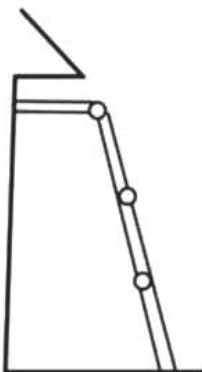

OVERHANG  
LADDER

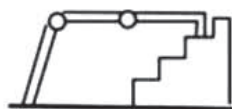

STAIRWELL  
SCAFFOLD

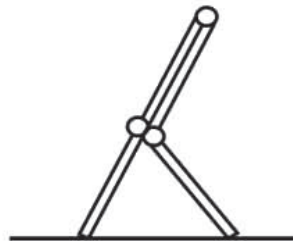

HERRINGBONE

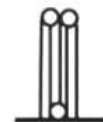

STORAGE

## SAFETY INSTRUCTIONS

- This ladder may only be used in the positions as shown above.
- Due care and attention should be paid at all times when using the ladder.
- Always check the stability of the ladder by ensuring that it is placed on level and solid ground.
- Always check that all hinges are in the correct positions for your particular use.
- Set at proper (75.5 degree) angle in straight position.

This multi-functional ladder is equipped with 2 iron panels for better standing on the scaffold or platform ladder, and there are 2 different length panels with curved end and 2 hooks to add stability and safety while using.

The flat ends are positioned on the middle of the upper rungs in platform ladder mode

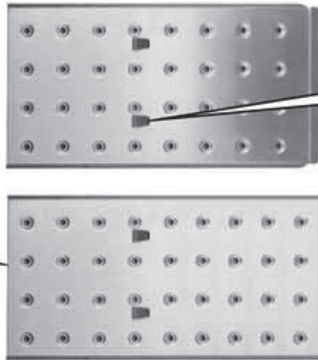

Hooks add extra security

The curve ends are mounted on the outermost of the upper rungs

### Instructions:

1. Configure the ladder as a scaffold or a platform ladder



2. Put the 2 panels atop the upper rungs, with their flat ends placed in the middle and supported by at least half a rung



3. Mount the curved ends to the outermost of the upper rungs, and make sure the panels are non-slip by locking the hooks with the rungs

