



IN221100393V01_US

A20-238



Solar Shower Instruction



IMPORTANT, RETAIN FOR FUTURE REFERENCE: READ CAREFULLY

ASSEMBLY INSTRUCTION

Dear customer,







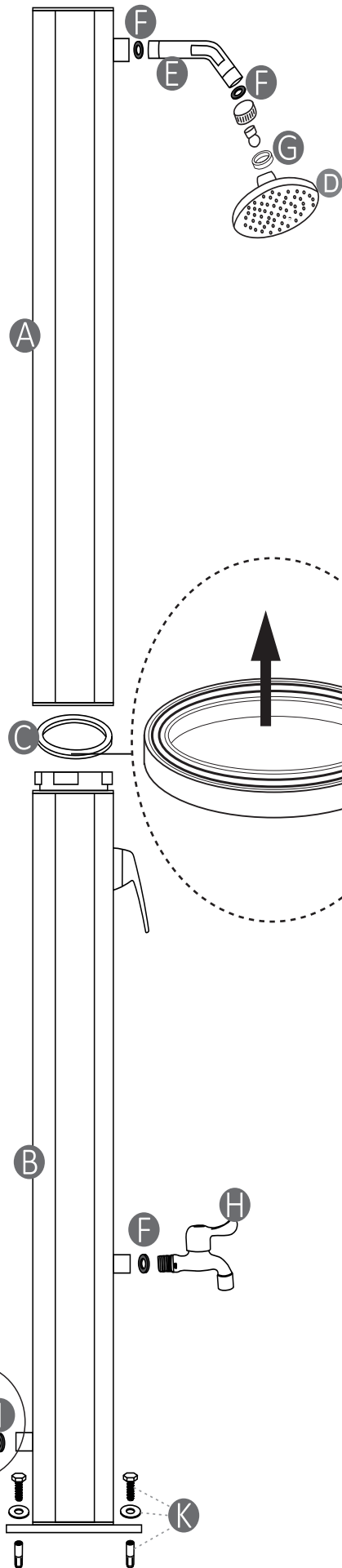



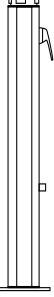

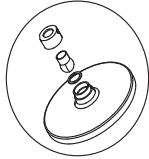
Thank you for purchasing this product. So that your appliance serves you well, please read all the instructions in this user's manual. If you have any questions, please contact our customer care center.

Our contact details are below:

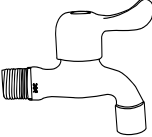
Country	 Phone	 Email
US	001-877-644-9366	customerservice@aosom.com

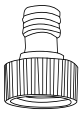

Parts List

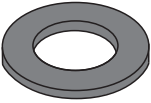
A  1x	B  1x	C  1x
D  1x	E  1x	F  Ø 19 mm 3x
G  Ø 24 mm 1x	H  1x	I  Ø 19 mm 2x
J  J ₁  J ₂ 1x	K    4x	L  Ø 24 mm 1x

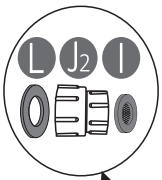

OR

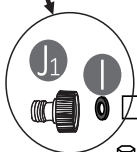

ASSEMBLY INSTRUCTIONS

1. Choose a location that can access sunlight for your solar shower.
2. Attach the lower stand with a shower base (B) to a concrete slab or wood base using four bolts, washers and nuts (K). It is recommended to use a wrench.
3. Attach the shower head (D) to the extension pipe (E) using a gasket (G). Attach the extension pipe (E) onto the upper stand (A) using a gasket (F). Adjust the parts with your hands, do not use a wrench.
4. Put the O-ring (C) onto the lower stand (B).
5. Place the upper stand (A) onto the lower stand (B). Connect the hoses.
6. Turn the locking ring clockwise to connect the two stands (A & B). Handle and shower head (D) need to face in the same direction.

SETTING UP THE SOLAR SHOWER

1. Open the handle and turn it to 'hot', so no air pockets are trapped in the hose when filling with water.
2. Attach your garden hose to the hose connector (J1 General standard or J2 US standard). Turn on the water to fill the solar shower. It will take a few minutes to fill up.
3. When the water flows out of the shower head (D), turn the handle off. The water will begin to heat.
4. Depending on the amount of sunlight and the current temperature, the solar shower will take approximately two hours to fully heat.
5. Water temperature can reach up to 60 °c in direct sunlight.

WARNING: Turn the handle to 'cold' before using to avoid scalding. Then adjust to your desired temperature.

DURING WINTER

1. Turn off and disconnect the garden hose.
2. Turn the handle to 'hot' so the water can drain. This takes approximately 8-10 minutes. Do not turn the handle when draining, otherwise it will stop.
3. Turn the locking ring anticlockwise to detach the upper stand (A) from the lower stand (B). Disconnect the hose, so the water can drain.
4. Disassemble the lower stand (B) and drain the remaining water from the shower.
5. Clean and dry all shower parts.
6. Keep parts in a dry indoor location during winter to prevent damage.

ATTENTION

- Do not use salt or other anti freezing methods.
- Recommended water pressure: Maximum 3.5 bars. Never use an additional pump or domestic water supply for the solar shower.
- Before using, let the water run for several minutes to rid the smell of plastic and oil.