

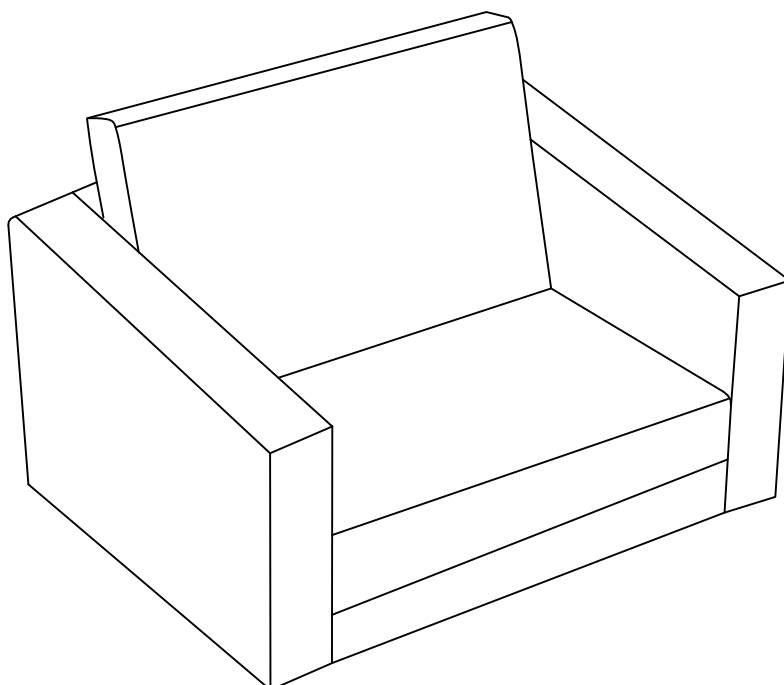

IN221100411V01_US_CA

310-035



EN: **WARNING:** Suitable for children of 3-6 years old; Max weight: 45 kg.

FR: **ATTENTION:** Convient aux enfants de 3 à 6 ans; Poids maximum : 45 kg.

EN IMPORTANT, RETAIN FOR FUTURE REFERENCE: READ CAREFULLY.

FR IMPORTANT: A LIRE ATTENTIVEMENT ET À CONSERVER POUR CONSULTATION ULTÉRIEURE.

WARNING:

1. CHOKING HAZARD—Small parts. Not for children under 3 years.
2. Only allowed for adults to install, keep children away.
3. To be used under the direct supervision of an adult.
4. Place it on a flat and clean floor, Check all the parts are well connected before use.

MAINTENANCE & CARE

- A. Keep all instructions and parts relating to this product for future reference.
- B. Please wipe down with a dry or damp cloth.

AVERTISSEMENT :

1. RISQUE D'ÉTOUFFEMENT - Petites pièces. Déconseillé aux enfants de moins de 3 ans.
2. Installation par des adultes uniquement, tenir les enfants à l'écart.
3. À utiliser sous la surveillance directe d'un adulte.
4. Posez-le sur un sol plat et propre. Vérifiez que toutes les pièces sont bien connectées avant toute utilisation.

ENTRETIEN ET MAINTENANCE

- A. Conservez toutes les instructions et les pièces relatives à ce produit pour pouvoir vous y référer ultérieurement.
- B. Veuillez essuyer avec un chiffon sec ou humide.

US

If you have any questions, please contact our customer care center.
Our contact details are below:



001-877-644-9366



customerservice@aosom.com

Imported by Aosom LLC
27150 SW Kinsman Rd Wilsonville, OR 97070 USA
MADE IN CHINA

CA

If you have any questions, please contact our customer care center.
Our contact details are below:

Si vous avez la moindre question, veuillez contacter notre centre d'assistance à la clientèle.
Nos coordonnées sont les suivantes:



416-792-6088



customerservice@aosom.ca

Imported by Aosom Canada Inc.
1251 Tapscott Road, Unit 101, Scarborough, Ontario Canada M1X 1S9
MADE IN CHINA

Importé par Aosom Canada Inc.
1251 Rue Tapscott, Unité 101, Scarborough, Ontario Canada M1X 1S9
FABRIQUÉ EN CHINE

A x 1

B x 1

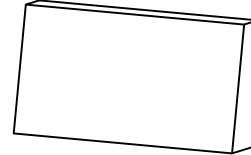
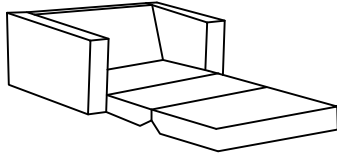

C x 1

D x 2

E x 2

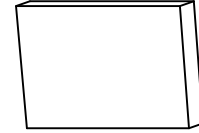
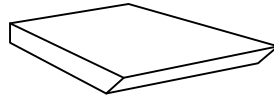
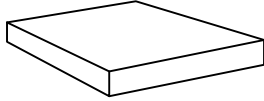

Compression packing bag

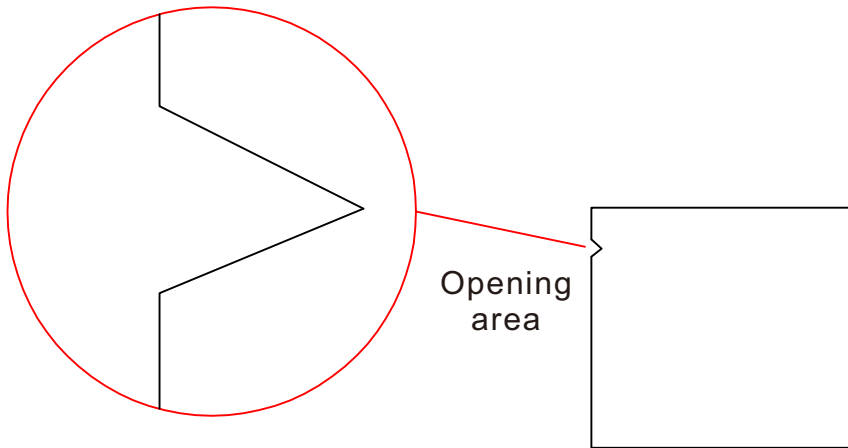

01

