

EN_IMPORTANT, RETAIN FOR FUTURE REFERENCE: READ CAREFULLY.

FR_IMPORTANT: A LIRE ATTENTIVEMENT ET À CONSERVER POUR CONSULTATION ULTÉRIEURE.

ES_IMPORTANTE, LEA Y GUARDE PARA FUTURAS REFERENCIAS.

PT_IMPORTANTE, RETER PARA REFERÊNCIA FUTURA: LEIA ATENTAMENTE.

DE_WICHTIG! SORGFÄLTIG LESEN UND FÜR SPÄTER NACHSCHLAGEN AUFBEWAHREN.

IT_IMPORTANTE! CONSERVARE IL PRESENTE MANUALE PER FUTURO RIFERIMENTO E LEGGERLO ATTENTAMENTE.

EN

Dear customer,

Thank you for purchasing this product. So that your appliance serves you well, please read all the instructions in this user's manual. If you have any questions, please contact our customer care center, Our contact details are below:

FR

Cher client,

Nous vous remercions d'avoir acheté ce produit. Afin que vous puissiez profiter pleinement de votre appareil, veuillez lire toutes les instructions de ce manuel d'utilisation. Si vous avez la moindre question, veuillez contacter notre centre d'assistance à la clientèle, Nos coordonnées sont les suivantes:

DE

Sehr geehrter Kunde,

Vielen Dank, dass Sie dieses Produkt erworben haben. Damit Ihr Gerät Ihnen gute Dienste leistet, lesen Sie bitte alle Hinweise in diesem Benutzerhandbuch. Wenn Sie Fragen haben, wenden Sie sich bitte an unser Kundendienstzentrum, Unsere Kontaktdaten stehen unten:

ES

Queridos clientes,

Gracias por comprar este producto. Para que su electrodoméstico le sirva mejor, lea todas las instrucciones de este manual del usuario. Si tiene alguna pregunta, comuníquese con nuestro Centro de Atención al Cliente, Nuestros datos de contacto son los siguientes:

PT

Caros clientes,

Obrigado por adquirir este produto. Para que o seu aparelho o sirva melhor, leia todas as instruções deste manual do utilizador. Se tiver alguma dúvida, por favor contacte o nosso Centro de Atendimento ao Cliente, Os nossos dados de contacto são os seguintes:

IT

Caro Cliente,

Grazie per aver acquistato questo prodotto. Per servirti meglio con questo apparecchio ti prego di leggere tutte le istruzioni in presente manuale utente. In caso di dubbio, si prega di contattare il nostro centro assistenza clienti, I nostri dettagli di contatto sono di seguito:

Country	 Phone	 Email
US	001-877-644-9366	customerservice@aosom.com
CA	416-792-6088	customerservice@aosom.ca
UK	0044-800-240-4004	enquiries@mhstar.co.uk
DE	0049-0(40)-88307530	service@aosom.de
FR	0033-1-84166106	aosom@mhfrance.fr
ES&PT	0034-931294512	atencioncliente@aosom.es
IT	0039-0249471447	clienti@aosom.it

WARNING:

1. CHOKING HAZARD—Small parts.
2. Only allowed for adults to install, keep children away.
3. To be used under the direct supervision of an adult.
4. Check all the parts are well connected before use.
5. Regularly check and maintain the main components (suspenders, fasteners, fixings, etc.), otherwise the swing may tip over or cause a fall.
6. Installation area should be as wide as possible, flat and avoid dampness.
7. Keep away from fire.

MAINTENANCE

1. Please wipe the surface stains of product with a dry cloth. If necessary, use mild soap or detergent to clean them. After wiping with a soft wet cloth, wipe them with a dry cloth. Do not use a strong acid-alkaline cleaning solution to clean them.
2. If not used for a long time, please put it in a cool and dry place and cover it with clean cloth or blanket.

AVERTISSEMENT :

1. Risque d'étouffement - Présence de petites pièces.
2. Installation par des adultes exclusivement, ne pas laisser les enfants s'approcher.
3. Surveillance permanente par un adulte lors de l'utilisation.
4. Vérifiez que toutes les pièces sont bien connectées avant utilisation.
5. Vérifiez et entretenez régulièrement les principaux composants (suspensions, attaches, fixations, etc.), sinon la balançoire peut basculer ou provoquer une chute.
6. La zone d'installation doit être aussi large que possible, plate et non humide.
7. Tenir à l'écart du feu.

ENTRETIEN

1. Veuillez essuyer les taches de surface sur le produit avec un chiffon sec. Si nécessaire, utilisez un savon doux ou un détergent pour les nettoyer. Après les avoir essuyées avec un chiffon doux et humide, essuyez-les avec un chiffon sec. N'utilisez pas de solution de nettoyage acide ou alcaline forte pour les nettoyer.
2. Si vous ne l'utilisez pas pendant une longue période, rangez-le dans un endroit frais et sec et couvrez-le d'un tissu ou d'une couverture propre.

WARNUNG:

1. ERSTICKUNGSGEFAHR-Kleinteile.
2. Darf nur von Erwachsenen installiert werden, halten Sie Kinder fern.
3. Nur unter der direkten Aufsicht eines Erwachsenen verwenden.
4. Prüfen Sie vor dem Gebrauch, ob alle Teile gut miteinander verbunden sind.
5. Überprüfen und warten Sie regelmäßig die Hauptbauteile (Aufhängungen, Verschlüsse, Befestigungen usw.), sonst kann die Schaukel umkippen oder einen Sturz verursachen.
6. Die Aufstellfläche sollte so breit wie möglich und flach sein und Feuchtigkeit vermeiden.
7. Von Feuer fernhalten.

WARTUNG

1. Bitte wischen Sie die Oberflächenflecken des Produkts mit einem trockenen Tuch ab. Falls erforderlich, verwenden Sie milde Seife oder Reinigungsmittel, um sie zu reinigen. Nach dem Abwischen mit einem weichen, feuchten Tuch, wischen Sie sie mit einem trockenen Tuch ab. Verwenden Sie zum Reinigen keine stark säurehaltige oder alkalische Reinigungslösung.
2. Wenn sie längere Zeit nicht benutzt wird, stellen Sie sie bitte an einen kühlen und trockenen Ort und decken Sie sie mit einem sauberen Tuch oder einer Decke ab.

ADVERTENCIA:

1. PELIGRO DE ASFIXIA: Contiene piezas pequeñas.
2. Sólo puede ser montado e instalado por un adulto, mantenga a los niños alejados del área de instalación.
3. Debe ser utilizado bajo la supervisión directa de un adulto.
4. Compruebe si todas las piezas estén conectadas bien antes de utilizarlo.
5. Inspeccione y realice mantenimiento para los componentes principales regularmente (tirantes, sujetadores, fijaciones, etc.), de lo contrario, el columpio puede volcarse o causar una caída.
6. El área para realizar la instalación debe ser lo más amplia posible, nivelada y puede evitar la humedad.
7. Mantenga el columpio y tobogán infantil alejado del fuego.

MANTENIMIENTO

1. Limpie las manchas en superficie del columpio y tobogán infantil con un paño seco. Si es necesario, utilice un jabón suave o detergente para limpiarlos. Después de limpiarlos con un paño suave húmedo, séquelos con un paño seco. No utilice una solución de limpieza ácido-alkalina fuerte para realizar la limpieza.
2. Si el columpio y tobogán infantil no se utiliza durante mucho tiempo, guárdelo en un lugar fresco y seco y cúbralo con una tela o una manta limpia.

















































AVVERTENZE:

1. RISCHIO DI SOFFOCAMENTO - Piccole parti.
2. Consentito solo agli adulti di installare, e tenere lontani i bambini.
3. Viene utilizzato sotto la diretta supervisione di un adulto.
4. Controllare che tutte le parti siano ben collegate prima dell'uso.
5. Controllare e mantenere regolarmente i componenti principali (strutture di sospensione, elementi di fissaggio, fissaggi, ecc.), altrimenti l'oscillazione potrebbe causare il ribaltamento o una caduta.
6. La zona per installazione deve essere il più ampia possibile, piatta ed evitare l'umidità.
7. Tenere lontano dal fuoco.











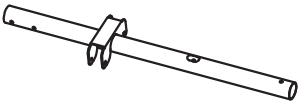

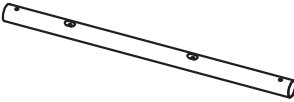

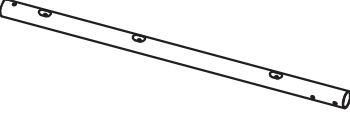

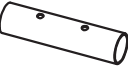



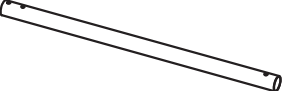

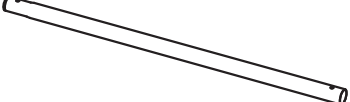



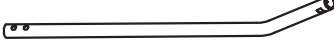

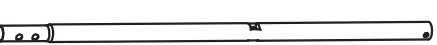







MANUTENZIONE:

1. Si prega di pulire le macchie superficiali del prodotto con un panno asciutto. Se necessario, utilizzare sapone o detergente morbido per pulirle. Dopo le aver pulito con un panno morbido e umido, pulire con un panno asciutto. Non utilizzare un forte detergente alcalino o acido.
2. Se non viene utilizzato per lungo tempo, conservarlo in un luogo fresco e asciutto, e coprirlo con un pezzo di pulito tessuto o con una coperta.

HARDWARE

 M6  X11	 M6  X15	 M6  X16	 M6  X13
 M8  X27	 M8  X19	 M8  X30	 M10  X2
 M6*20  X5	 M6*35  X2	 M6*40  X5	
 M8*60  X9	 M8*78  X2	 M8*65  X9	
  X6	 M6*38  X9	 M8*50  X2	
  X1	  X8	  X4	  X2
  X2	  X1	  X4	

PARTS

 x 1 	 x 1 		
 x 1 	 x 2   x 4 		
 x 4 	 x 4 		
 x 2 	 x 2 		
 x 2 	 x 2 		
 x 2 	 x 2 	 x 2 	 
 x 2 	 x 4 	 x 2 	 x 2 

- (Z6) x8
- (Z9) x8
- (G2) x16
- (L8) x16
- (D8) x16
- (X1) x1
- (BF1) x1
- (BF2) x1
- (BF3) x1
- (YBB4) x4
- (YD1) x2
- (PQK) x1
- (BF4) x2
- (PJK) x4

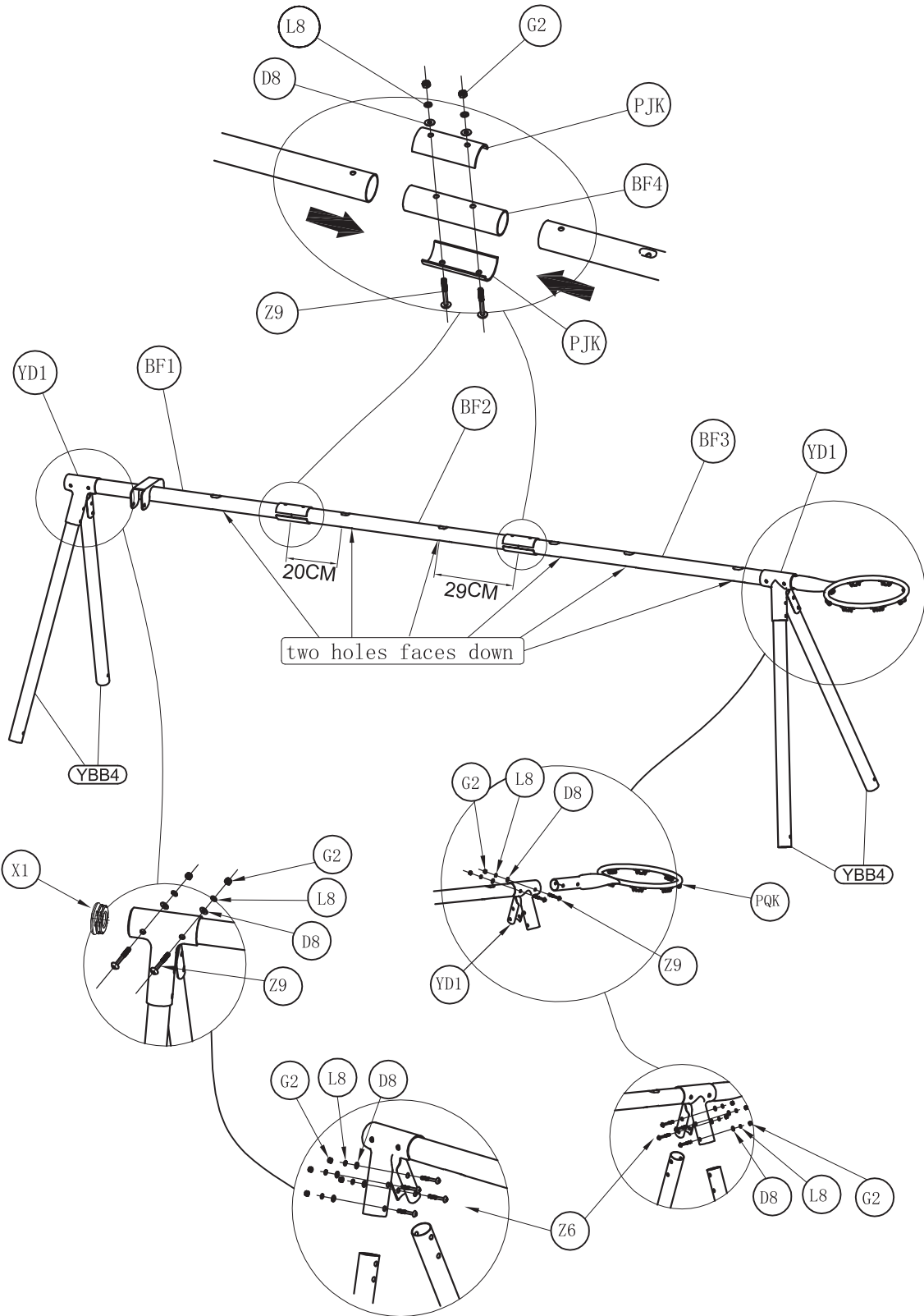

(YBB5) x2

(YB211) x4

(DW) x2

(C40) x2

(D3) x6

(Z5) x4

(G8) x4

(G2) x6

(L6) x4

(D6) x4

(D8) x6

(S5) x4

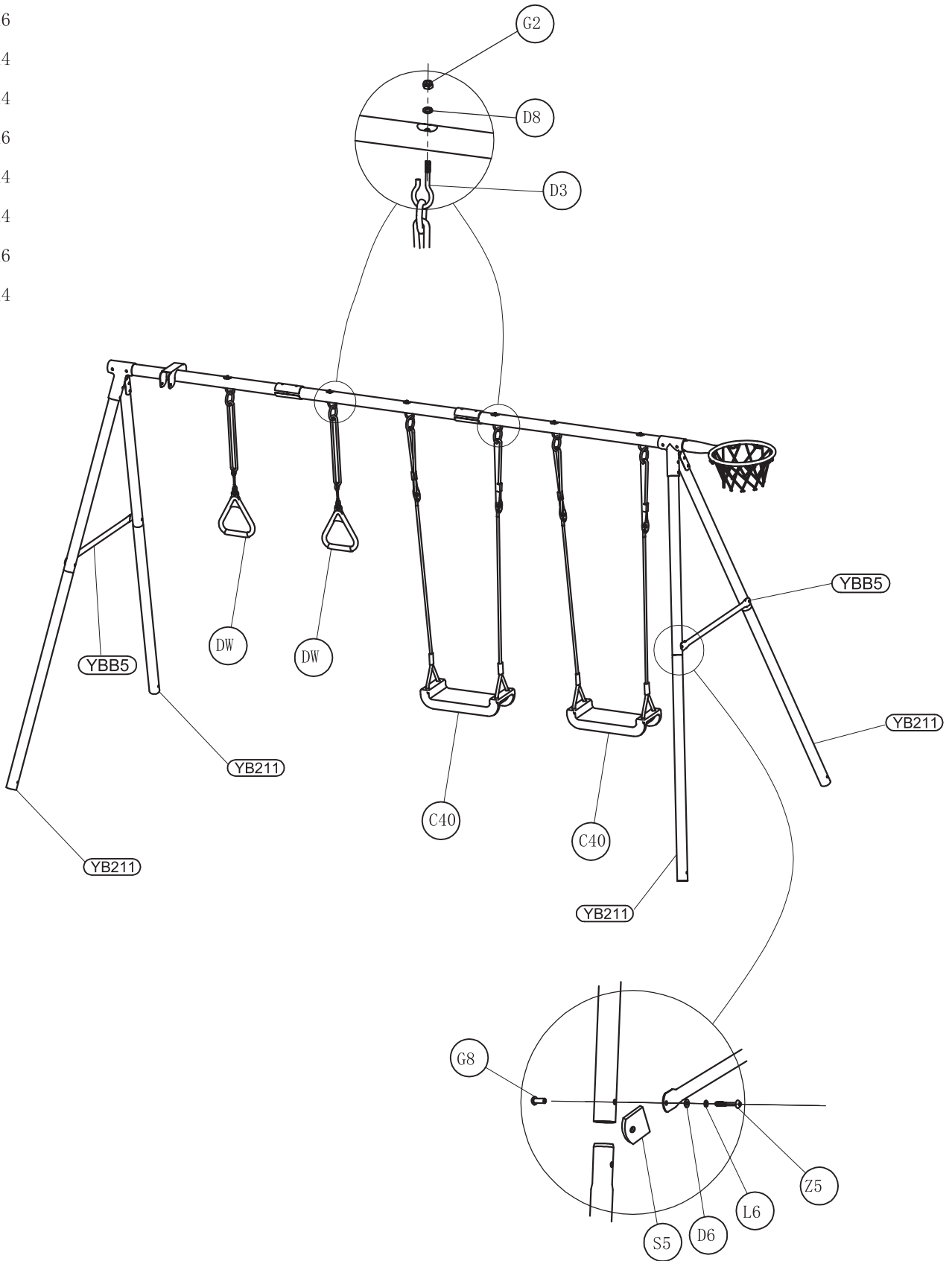

- (BH19) x2
- (BH20) x2
- (YB22) x2
- (F4) x2
- (T1) x4
- (Z8) x2
- (G2) x4
- (G8) x4
- (D6) x4
- (D8) x6
- (D10) x2
- (L6) x4
- (L8) x2
- (YC3) x8
- (S6) x2

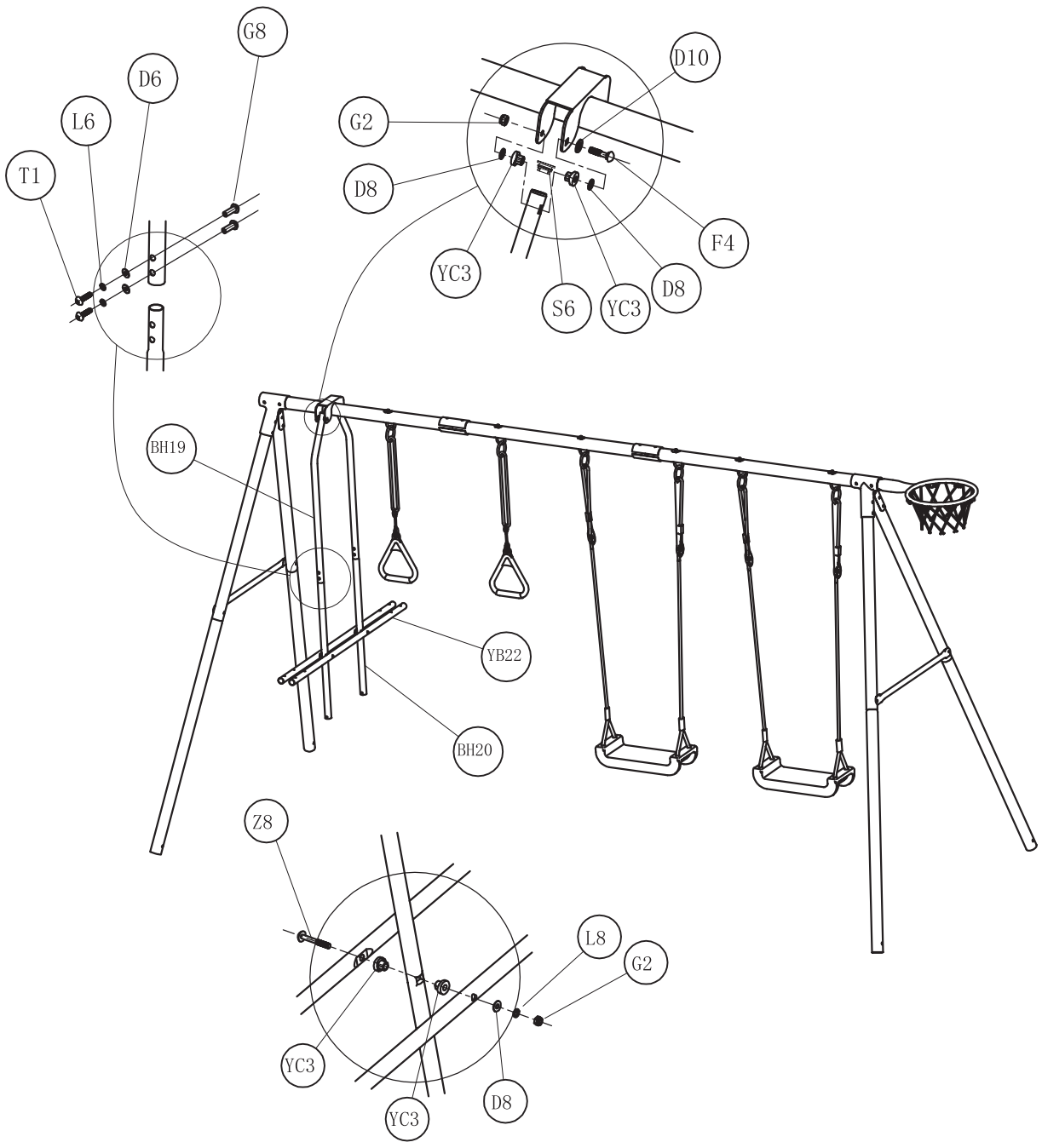

- (C50) x2
- (C51) x2
- (C52) x2
- (YD2) x4
- (F3) x8
- (Z4) x2
- (Z5) x4
- (G1) x10
- (G8) x4
- (D6) x6
- (L6) x6
- (X8) x4

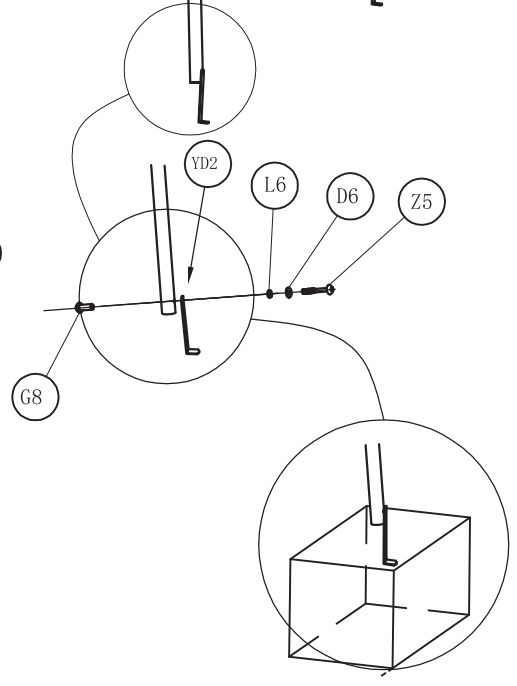
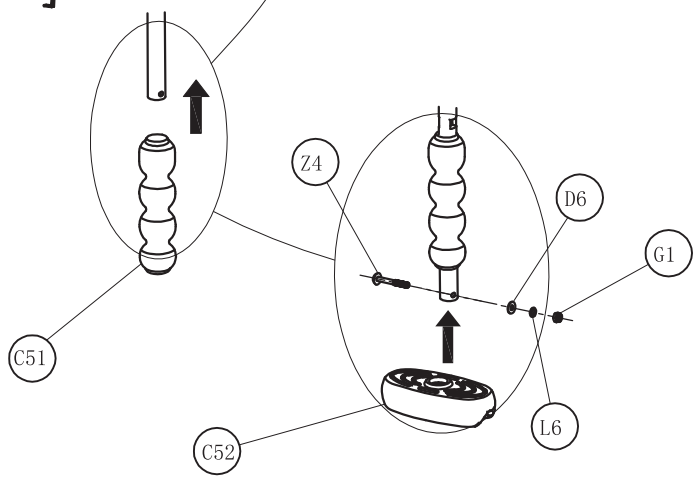
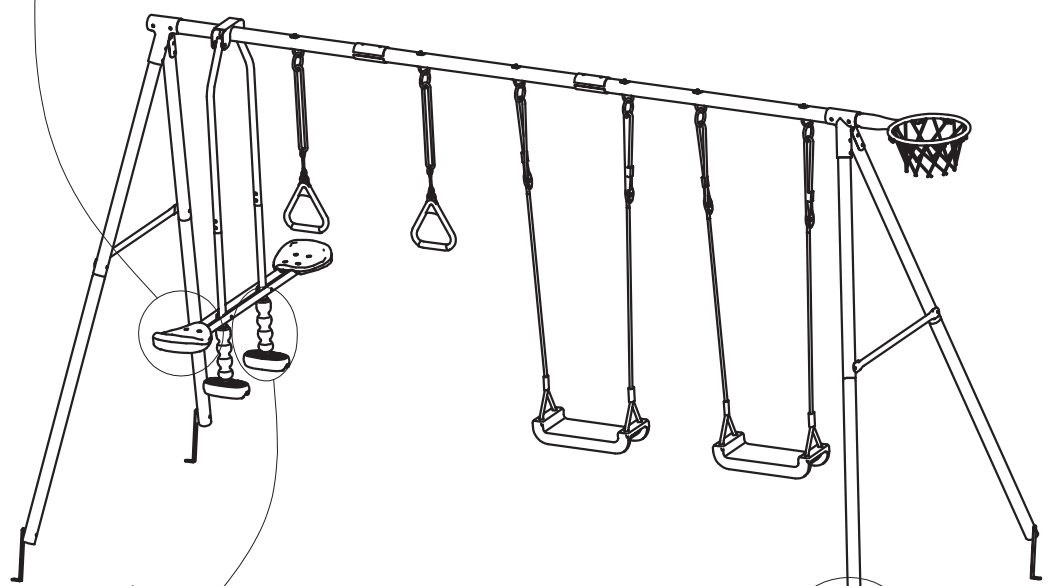
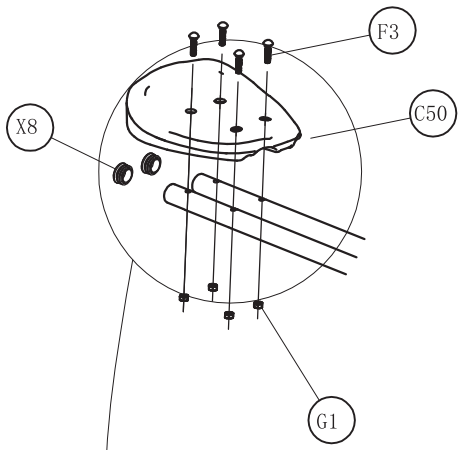

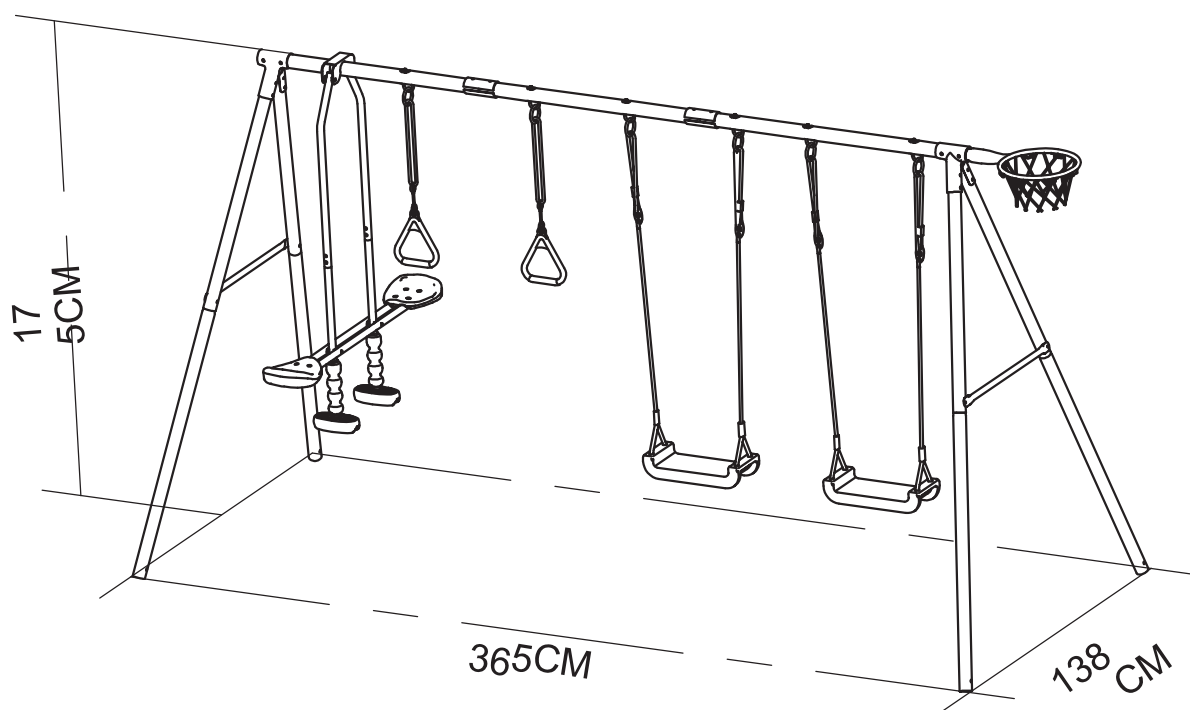

EN_ After assembling the swing, please stretch the length of the swing to the longest possible length when fixing the ground nails to keep it in a taut state, and then fix the ground nails and pour cement to make the swing more stable.

FR_ Après avoir assemblé la balançoire, veuillez étirer la balançoire le plus possible lors de la fixation des clous de sol pour la maintenir tendue, puis fixez les clous de sol et versez le ciment pour rendre la balançoire plus stable.

ES_ Después de montar el columpio, por favor, estire la longitud del columpio a la mayor longitud posible al fijar los clavos de tierra para mantenerlo en un estado tenso, y luego fijar los clavos de tierra y verter cemento para hacer el columpio más estable.

PT_ Depois de montar o balanço, por favor estique o comprimento do balanço ao comprimento mais longo possível ao fixar os pregos no solo para o manter em estado tenso, e depois fixe os pregos no solo e verta cimento para tornar o balanço mais estável.

DE_ Nach dem Zusammenbau der Schaukel sollten Sie die Schaukel beim Befestigen der Erdnägel so weit wie möglich dehnen, um sie straff zu halten, und dann die Erdnägel befestigen und Zement gießen, um die Schaukel stabiler zu machen.

IT_ Dopo aver assemblato l'altalena, si prega di allungare la lunghezza dell'altalena il più possibile quando si fissano i chiodi a terra per mantenerla tesa, quindi fissare i chiodi a terra e versare il cemento per rendere l'altalena più stabile.

US

Imported by Aosom LLC
 27150 SW Kinsman Rd Wilsonville, OR 97070 USA
 MADE IN CHINA

CA

Imported by Aosom Canada Inc.
 1251 Tapscott Road, Unit 101, Scarborough, Ontario Canada M1X 1S9
 MADE IN CHINA

Importé par Aosom Canada Inc.
 1251 Rue Tapscott, Unité 101, Scarborough, Ontario Canada M1X 1S9
 FABRIQUÉ EN CHINE

UK

IMPORTER ADDRESS:
 MH STAR UK LTD
 Unit 27, Perivale Park,
 Horsenden lane South
 Perivale, UB6 7RH
 MADE IN CHINA

FR

ADRESSE D'IMPORTATION:
 MH FRANCE
 2 Rue Maurice Hartmann
 92130 Issy Les Moulineaux
 France
 FABRIQUÉ EN CHINE



FR

Pensez à donner ou recycler.

 Association
 ou
 Magasin
 ou
 Déchèterie

<https://quefairedemesdechets.fr>

ES

IMPORTADOR:
 SPANISH AOSOM, S.L.
 C/ROC GROS,Nº15.08550, ELS HOSTALET DE BALENYÀ, SPAIN.
 B66295775
 WWW.AOSOM.ES
 ATENCIONCLIENTE@AOSOM.ES
 TEL: 931294512
 HECHO EN CHINA

DE

ADRESSE DES IMPORTEURE:
 MH Handel GmbH
 Wendenstraße 309
 D-20537 Hamburg
 Germany
 IN CHINA HERGESTELLT

IT

IMPORTATO DA:
 AOSOM Italy srl
 Centro Direzionale Milanofiori
 Strada 1 Palazzo F1
 20057 Assago (MI)
 P.I.: 08567220960
 FATTO IN CINA