

# PawHut

IN221100831V01\_GL

D32-017V00

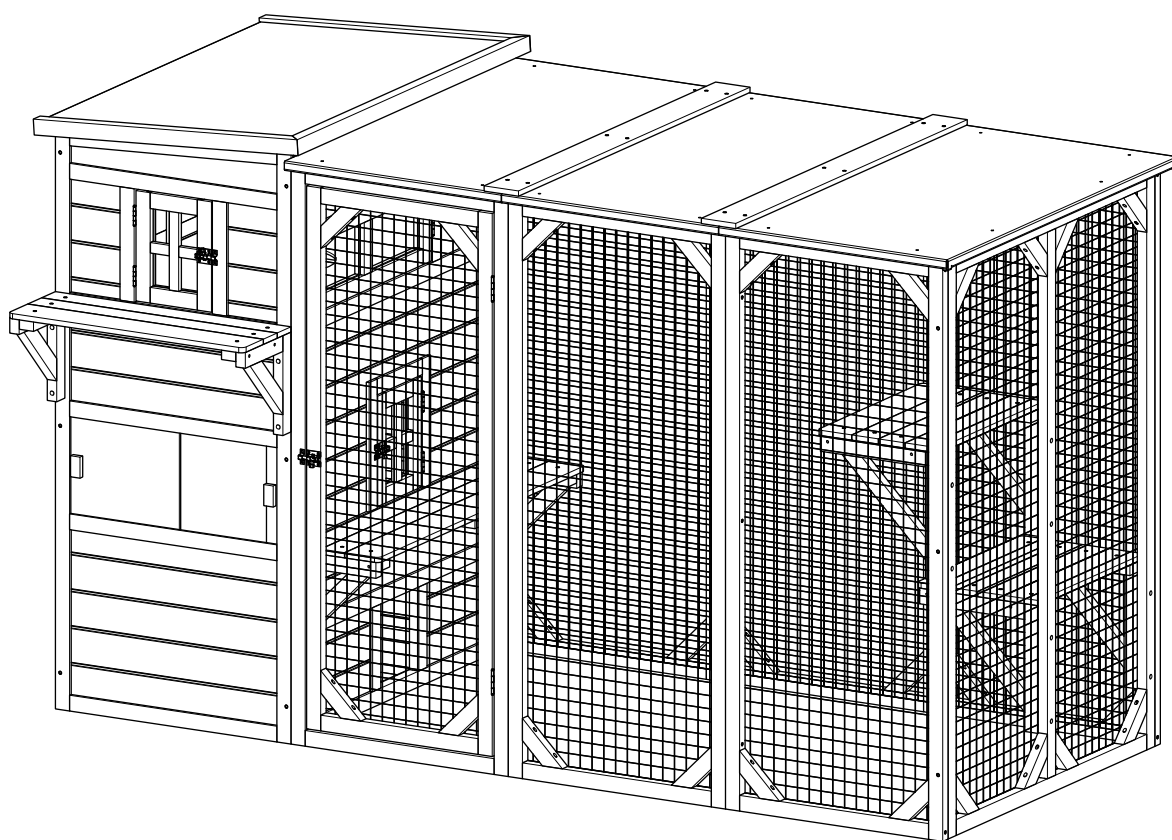

**18**

STEPS



2 HR

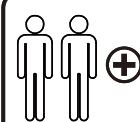

**EN\_IMPORTANT, RETAIN FOR FUTURE REFERENCE: READ CAREFULLY.**

**FR\_IMPORTANT: A LIRE ATTENTIVEMENT ET À CONSERVER POUR CONSULTATION ULTÉRIEURE.**

**ES\_IMPORTANTE, LEA Y GUARDE PARA FUTURAS REFERENCIAS.**

**DE\_WICHTIG! SORGFÄLTIG LESEN UND FÜR SPÄTER NACHSCHLAGEN AUFBEWAHREN.**

**IT\_IMPORTANTE! CONSERVARE IL PRESENTE MANUALE PER FUTURO RIFERIMENTO E LEGGERLO ATTENTAMENTE.**

BOX  
1-2

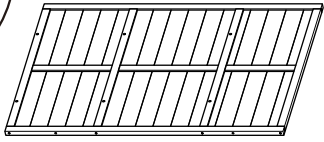

1 x 1

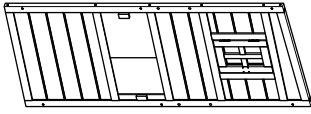

2 x 1

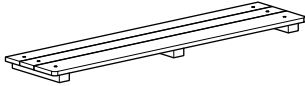

3 x 1

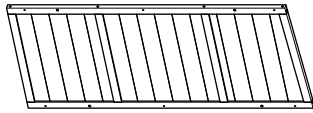

4 x 1

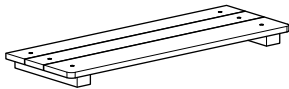

5 x 1

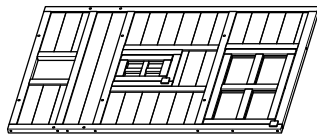

6 x 1

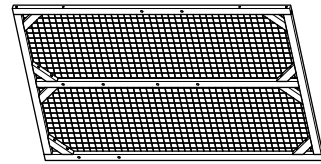

7 x 1

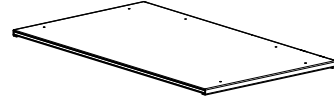

8 x 1

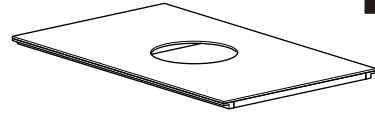

9 x 1

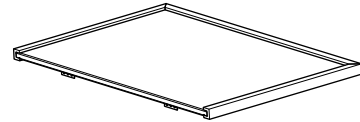

10 x 1



Hardware Kit

BOX  
2-2

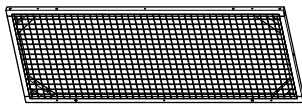

11 x 1

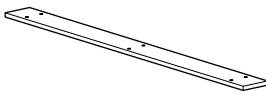

12 x 2

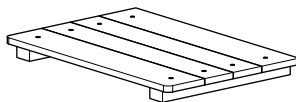

13 x 2

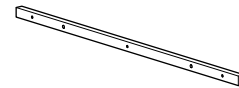

14 x 6

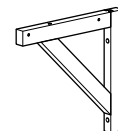

15 x 4

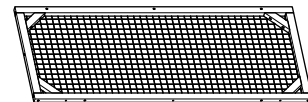

16 x 1

BOX  
2-2

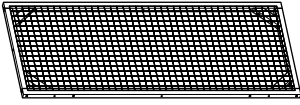

17 x 1

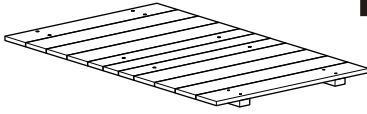

18 x 1

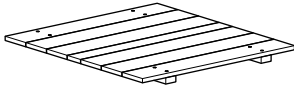

19 x 1

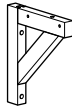

20 x 4

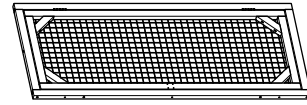

21 x 1

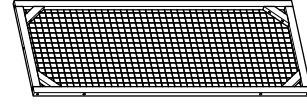

22 x 2

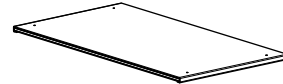

23 x 2

PARTS

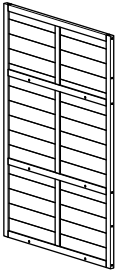

1 x 1



2 x 1

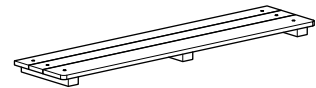

3 x 1

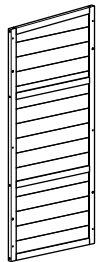

4 x 1

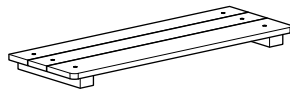

5 x 1

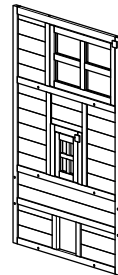

6 x 1

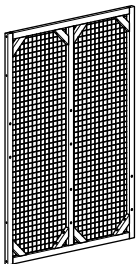

7 x 1

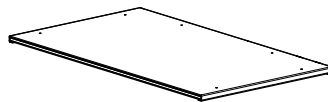

8 x 1

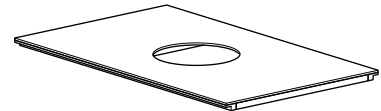

9 x 1

⑩ x 1

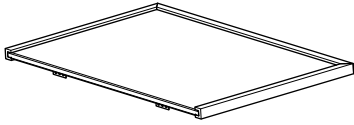

⑪ x 1



⑫ x 2

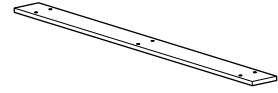

⑬ x 2

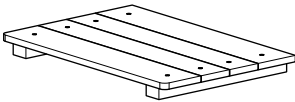

⑭ x 6

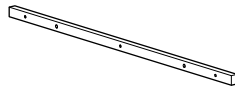

⑮ x 4

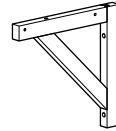

⑯ x 1

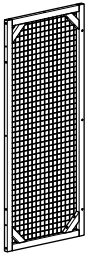

⑰ x 1

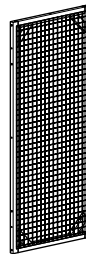

⑱ x 1

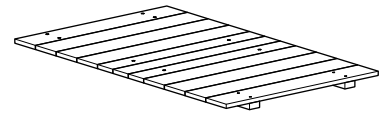

⑲ x 1

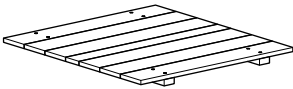

⑳ x 4

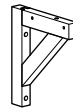

㉑ x 1

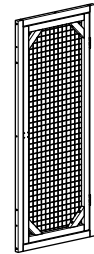

㉒ x 2

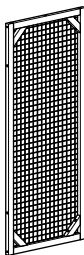

㉓ x 2

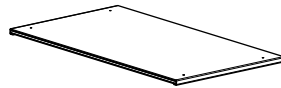

**A** x18

3.5\*50  
+1(spare)

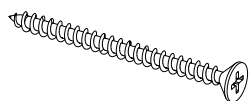

**B** x34

3.5\*40  
+2(spare)

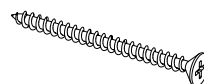

**C** x32

3.0\*30  
+2(spare)

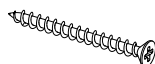

**D** x12

3.0\*23  
+1(spare)



**E** x38

3.0\*14  
+2(spare)



**F** x 4

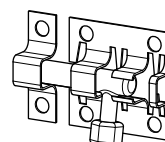

**G** x42

+2(spare)



**H** x16

M6\*55  
+1(spare)

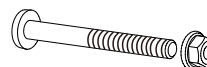

**L** x 1

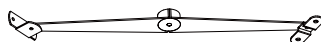

**R** x 1

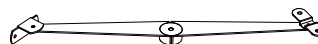

**EN**\_ Do not confuse similar screws.  
**FR**\_ Ne pas confondre des vis similaires.  
**ES**\_ No confunda tornillos similares.  
**DE**\_ Verwechseln Sie ähnliche Schrauben nicht.  
**IT**\_ Non confondere le viti simili.

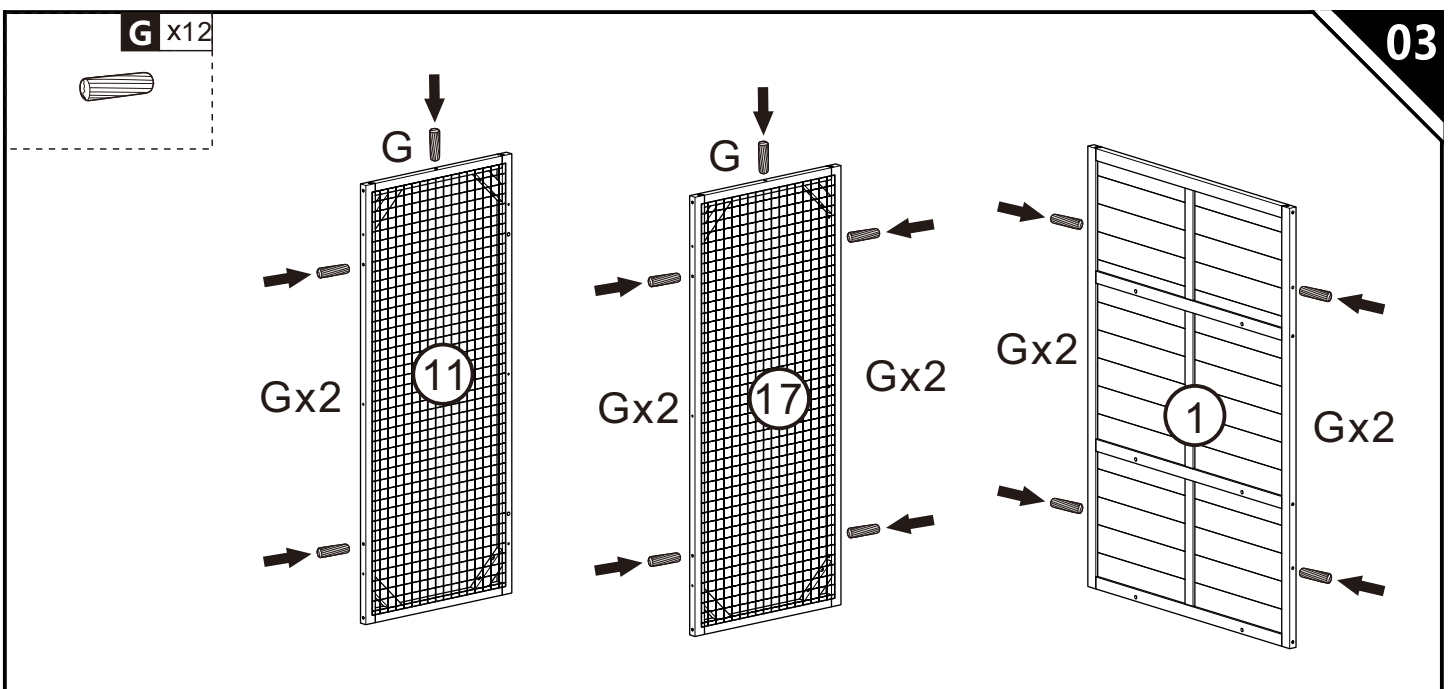
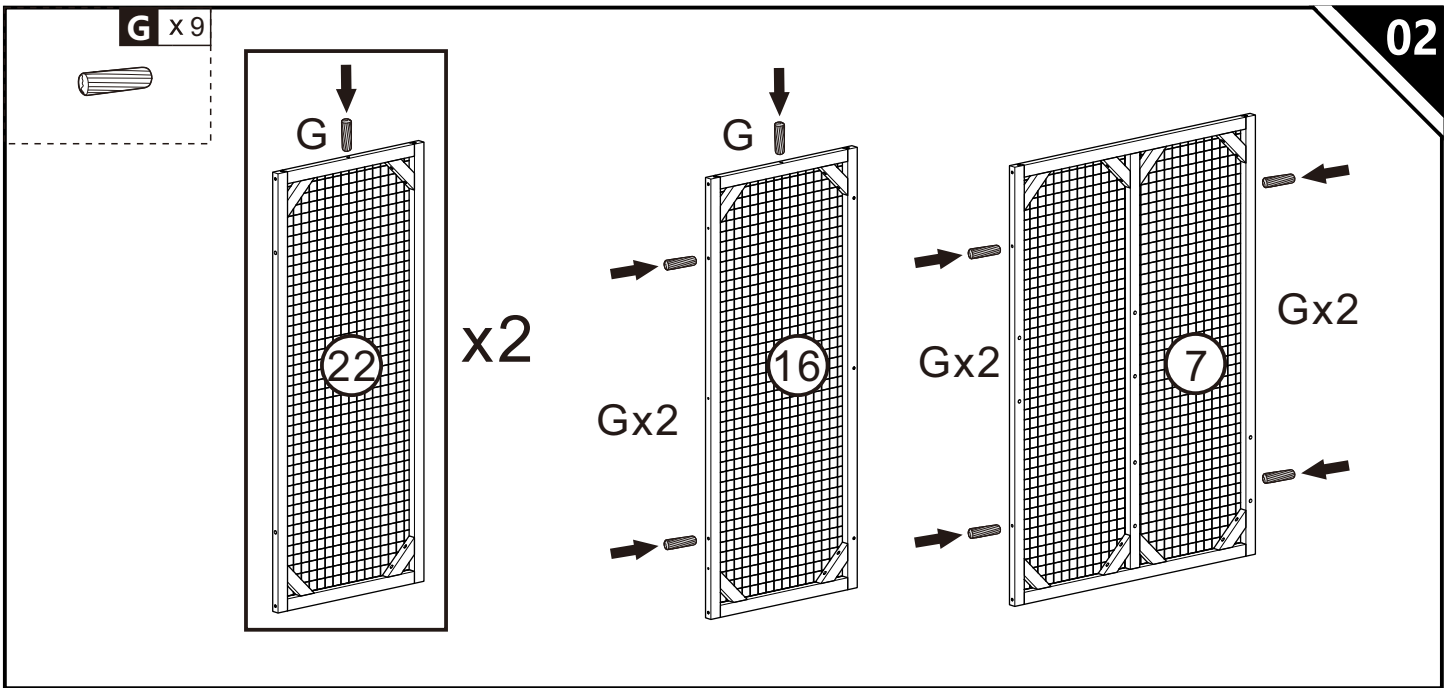
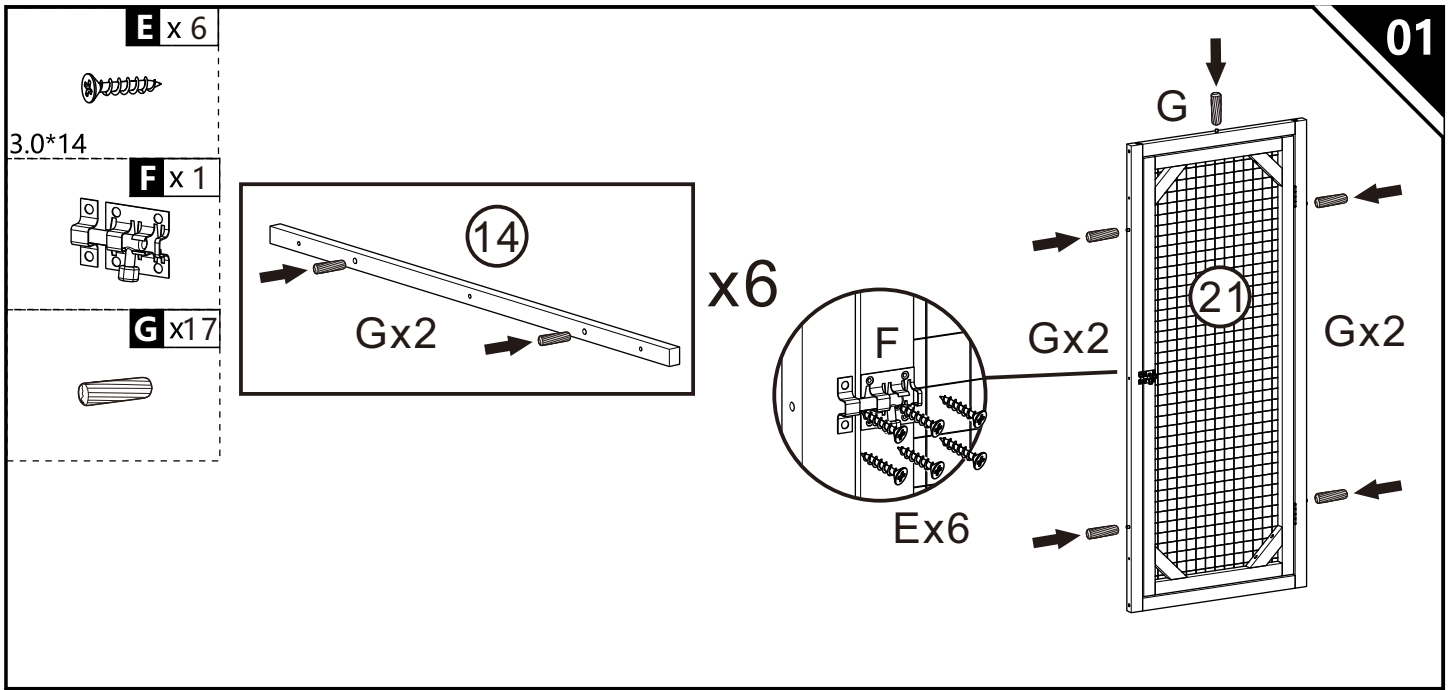

**E** x12



3.0\*14

**F** x 2

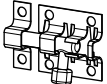

**G** x 4

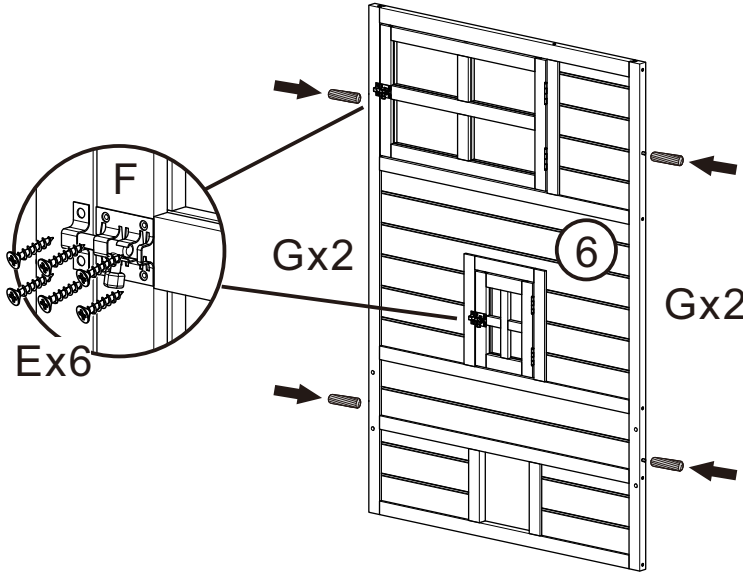

**C** x18



3.0\*30

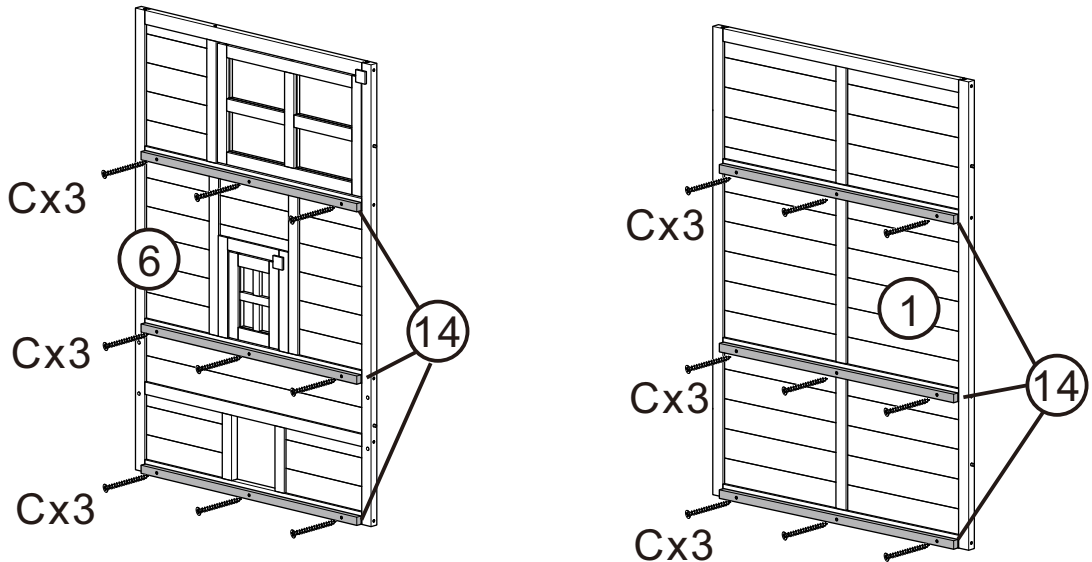

**E** x 6



3.0\*14

**F** x 1

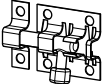

**H** x16



M6\*55

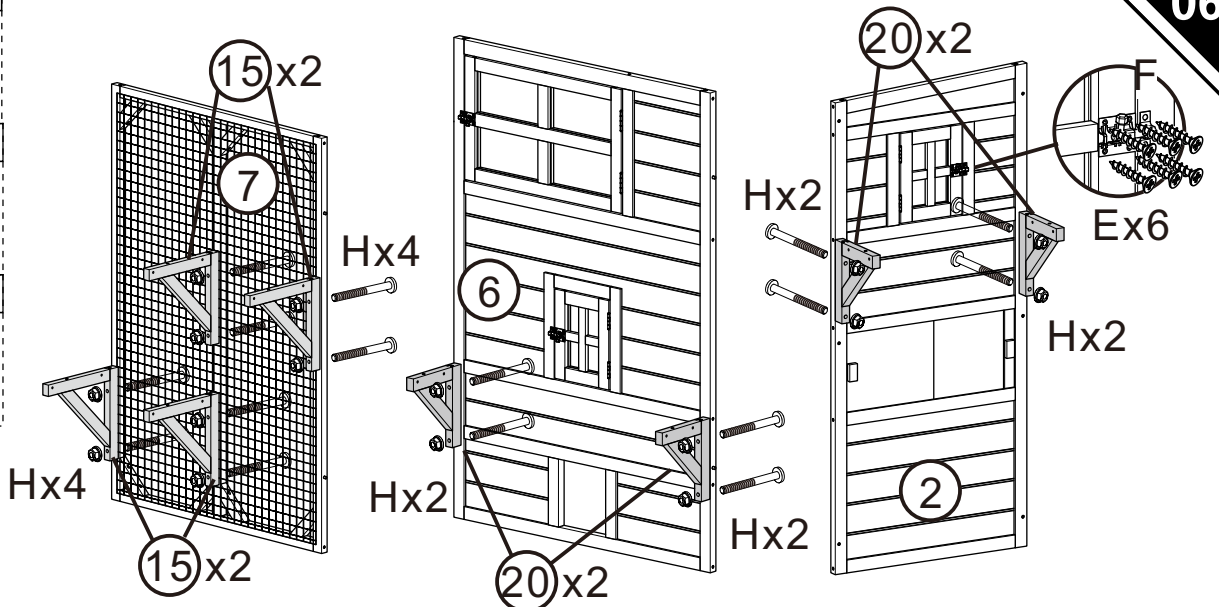

Bx16

3.5\*40

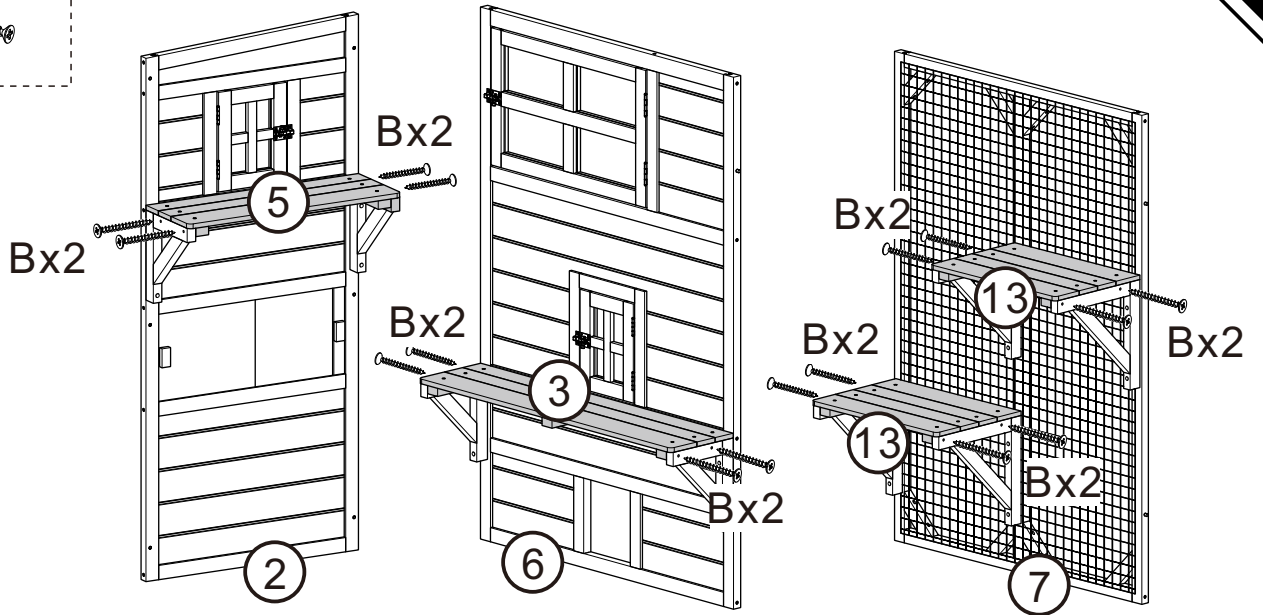

Bx6

3.5\*40

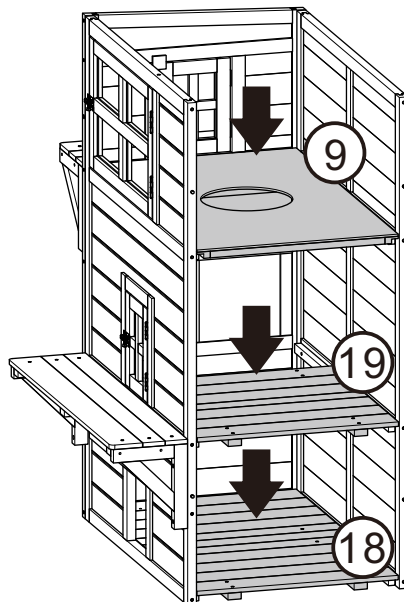
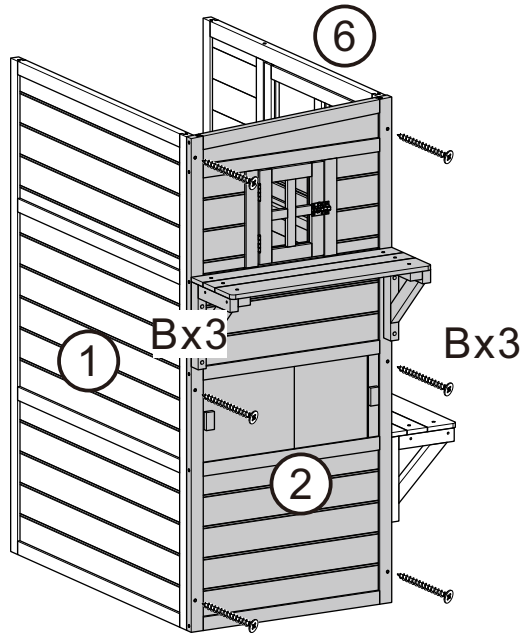



**Bx6**

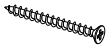

3.5\*40

**10**

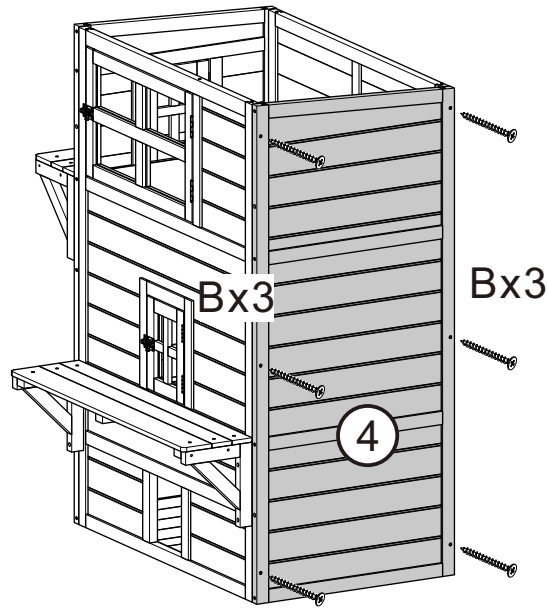

**Ax9**



3.5\*50

**11**

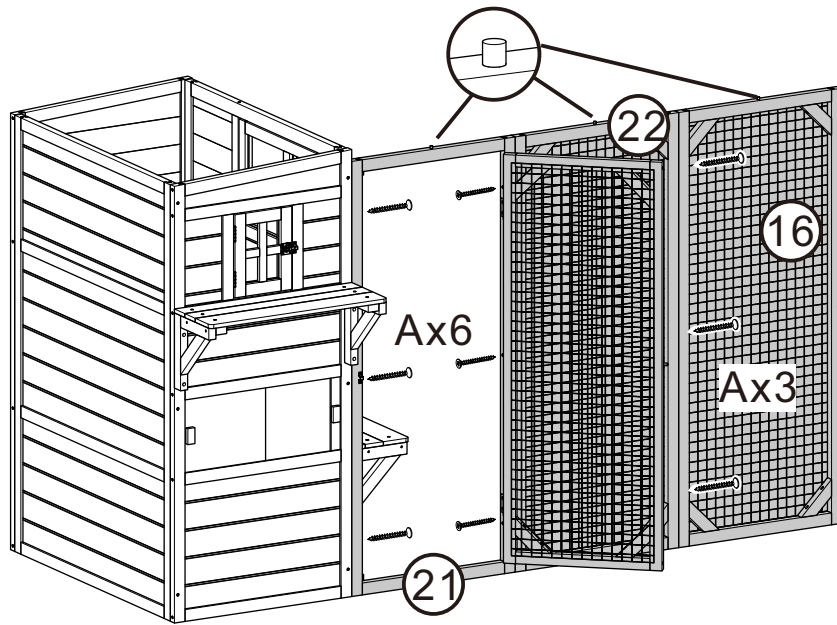

**Ax9**



3.5\*50

**12**

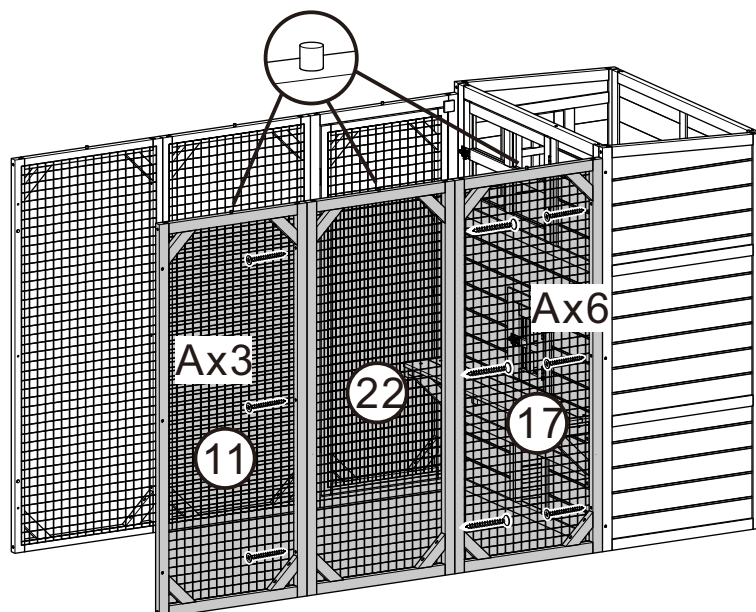

**B** x 6

3.5\*40

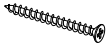

13

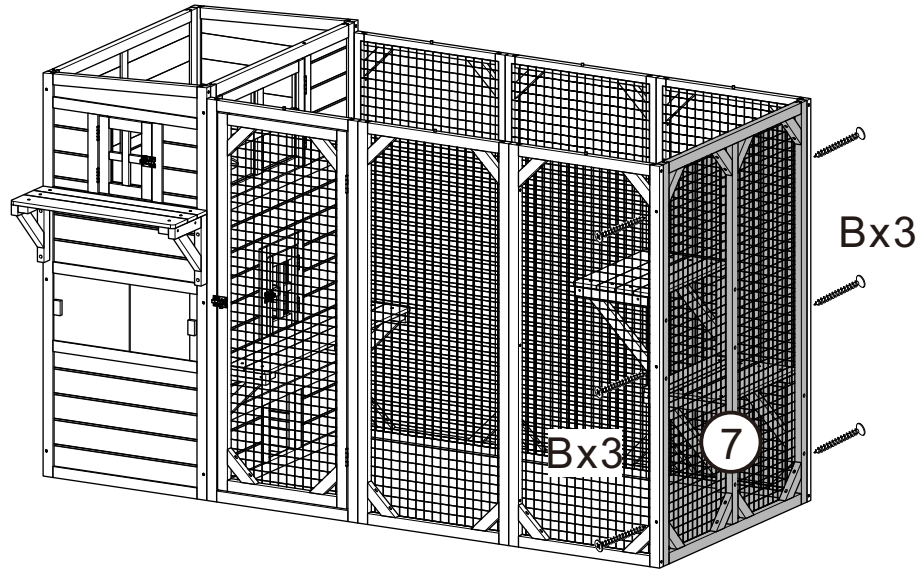

**C** x 14

3.0\*30



14

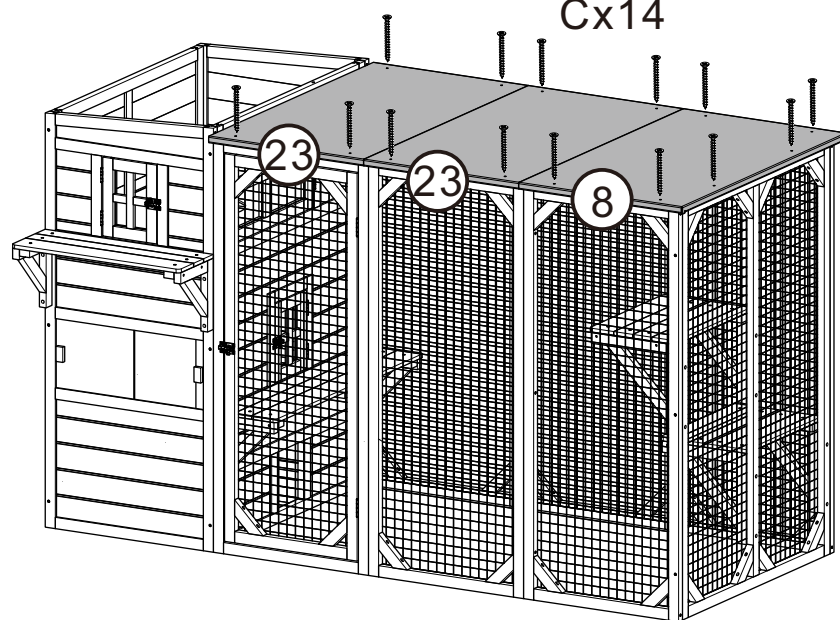

**E** x 6

3.0\*14



15

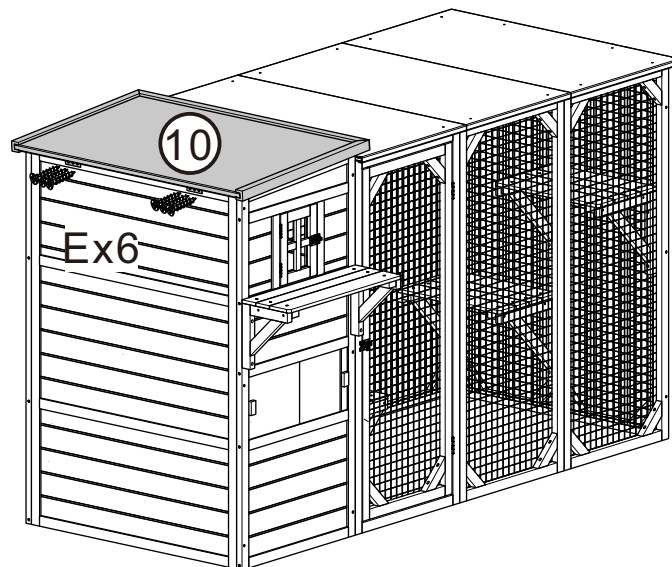

**E** x 8



3.0\*14

**L** x 1



**R** x 1

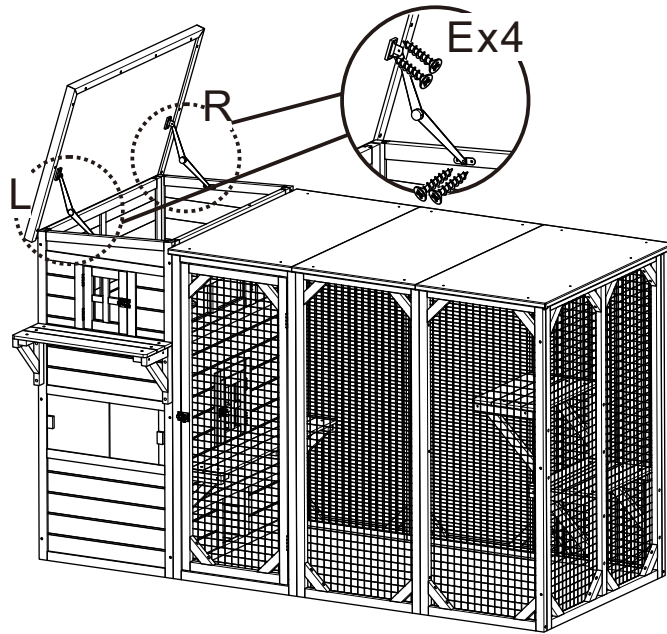

**D** x12

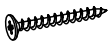

3.0\*23

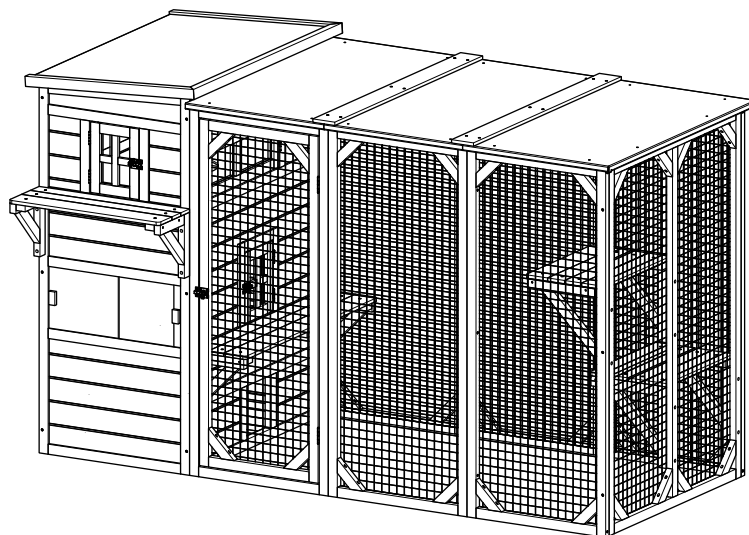
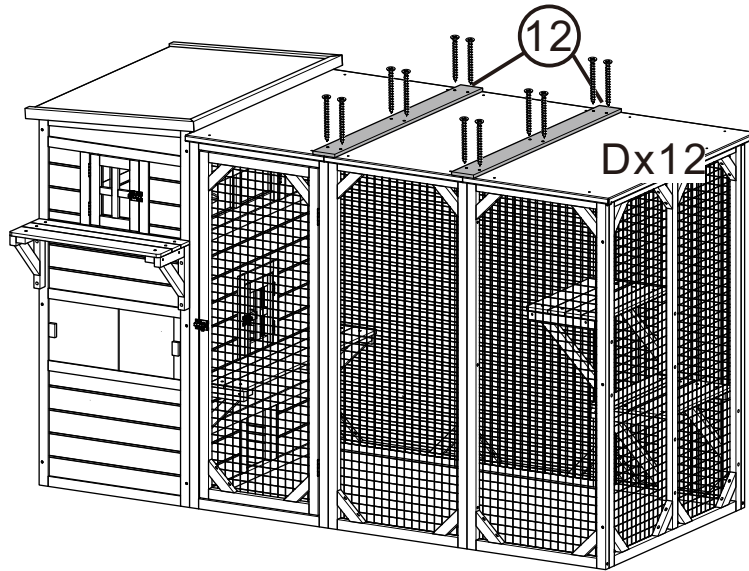

If you have any questions, please contact our customer care center, Our contact details are below:

**US**

 001-877-644-9366

 customerservice@aosom.com

Imported by Aosom LLC  
27150 SW Kinsman Rd Wilsonville, OR 97070 USA  
MADE IN CHINA

If you have any questions, please contact our customer care center, Our contact details are below:

**CA**

 416-792-6088

 customerservice@aosom.ca

Imported by Aosom Canada Inc.  
7270 Woodbine Avenue, Unit 307, Markham,  
Ontario Canada L3R 4B9  
MADE IN CHINA

Si vous avez la moindre question, veuillez contacter notre centre d'assistance à la clientèle, Nos coordonnées sont les suivantes:

 416-792-6088

 customerservice@aosom.ca

Importé par Aosom Canada Inc.  
7270 Woodbine Avenue, unité 307,  
Markham, Ontario Canada L3R 4B9  
FABRIQUÉ EN CHINE

If you have any questions, please contact our customer care center, Our contact details are below:

**UK**

 0044-800-240-4004

 enquiries@mhstar.co.uk

IMPORTER ADDRESS:  
MH STAR UK LTD  
Unit 27, Perivale Park,  
Horsenden lane South  
Perivale, UB6 7RH  
MADE IN CHINA

Si vous avez la moindre question, veuillez contacter notre centre d'assistance à la clientèle, Nos coordonnées sont les suivantes:

**FR**

 0033-1-84166106

 aosom@mhfrance.fr

Importé par/Fabricant/REP:  
MH FRANCE  
2 Rue Maurice Hartmann  
92130 Issy Les Moulineaux  
France  
FABRIQUÉ EN CHINE

Wenn Sie Fragen haben, wenden Sie sich bitte an unser Kundendienstzentrum, Unsere Kontaktdaten stehen unten:

**DE**

 0049-0(40)-88307530

 service@aosom.de

ADRESSE DES IMPORTEURE/Hersteller/REP:  
MH Handel GmbH  
Wendenstraße 309  
D-20537 Hamburg  
Germany  
IN CHINA HERGESTELLT

In caso di dubbio, si prega di contattare il nostro centro assistenza clienti, I nostri dettagli di contatto sono di seguito:

**IT**

 0039-0249471447

 clienti@aosom.it

IMPORTATO DA/Produttore/REP:  
AOSOM Italy srl  
Centro Direzionale Milanofiori  
Strada 1 Palazzo F1  
20057 Assago (MI)  
P.I.: 08567220960  
FATTO IN CINA

Si tiene alguna pregunta, comuníquese con nuestro Centro de Atención al Cliente, Nuestros datos de contacto son los siguientes:

**ES**

 0034-931294512

 atencioncliente@aosom.es

IMPORTADOR/Fabricante/REP:  
SPANISH AOSOM, S.L.  
C/ROC GROS, N°15.08550, ELS HOSTALETS DE  
BALENYÀ, SPAIN.  
B66295775  
HECHO EN CHINA

Se tiver alguma dúvida, por favor contacte o nosso Centro de Atendimento ao Cliente, Os nossos dados de contacto são os seguintes:

**PT**

 0034-931294512

 info@aosom.pt.

IMPORTADOR/Fabricante/REP:  
SPANISH AOSOM, S.L.  
C.ROC GROS N.15, 08550. ELS HOSTALETS DE  
BALENYÀ  
FEITO NA CHINA



**FR**

**DONNEZ  
OU  
RECYCLEZ**



ASSOCIATION

OU



LIVRAISON

OU



DÉCHÈTERIE

Adresses sur [quefairedemesdechets.fr](http://quefairedemesdechets.fr)