



**IMPORTANT, RETAIN FOR FUTURE REFERENCE: READ CAREFULLY**

# INSTRUCTION MANUAL

# Electric Fireplace Heater

**This product is only suitable for well-insulated spaces and occasional use**

Model	Voltage	Frequency	Power
YH-20-1B	220-240V~	50/60Hz	1800-2000W

## Features of the product:

This is an emulational flame electric fireplace. The theory of the product is to use a fan to flow the hot air heated by the heating elements in order to achieve the effect of indoor heating.

## Scope of delivery

**Immediately after unpacking please check that the delivery is complete and all product parts are in good condition.**

- 1 Electric heater
- 1 User manual
- 4 Legs
- 12 Screws





## Security Advice

1. The product cannot be used outdoors.
2. Any item covered or blocked the fireplace vent in any way is prohibited , or the fireplace will be dangerous caused by overheating.
3. Furniture, curtains or flammable materials should ensure that 1 meter away from the fireplace.
4. Cut off the power immediately if there is something wrong.
5. Please turn off the power if it is not used in a long time.
6. Please do not put the power cord on the front of the fireplace.
7. Although the machine has reached safety standards, we do not recommend that it is used on multi-use carpet or carpet Long Hair.
8. Dispose of the package carefully. Plastic packaging material may cause environmental pollution.
9. The product must be connected to the ground.
10. The fireplace must be used under the AC voltage rating.
11.  **WARNING:** In order to avoid overheating, do not cover the heater
12. The heater must not be located immediately below a socketoutlet.
13. Do not use this heater in the immediate surroundings of a bath, a shower or a swimming pool.
14. This appliance can be used by children aged from 8 years and above and persons with reduced physical, sensory or mental capabilities or lack of experience and knowledge if they have been given supervision or instruction concerning use of the appliance in a safe way and understand the hazards involved. Children shall not play with the appliance. Cleaning and user maintenance shall not be made by children without supervision.
15. In order to avoid a hazard due to inadvertent resetting of the thermal cutout, this appliance must not be supplied through an external switching device, such as a timer, or connected to a circuit that is regularly switched on and off by the utility.
16. If the supply cord is damaged, it must be replaced the manufacture or its service agent or a similarly qualified person must place it in order to avoid a hazard.

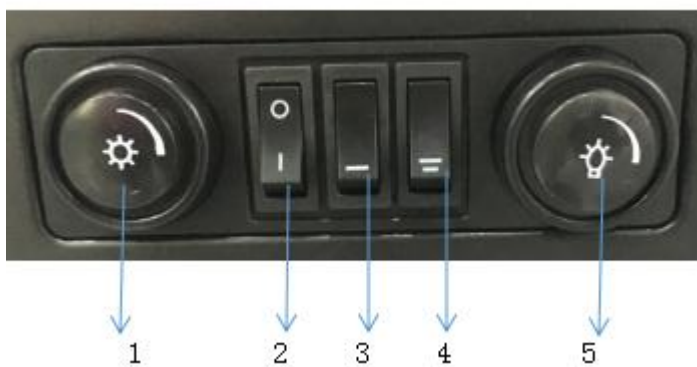
17. **WARNING:** This heater is not equipped with a device to control the room temperature. Do not use this heater in small rooms when they are occupied by persons not capable of leaving the room on their own, unless constant supervision is provided.
18. Children of less than 3 years should be kept away unless continuously supervised. Children aged from 3 years and less than 8 years shall only switch on/off the appliance provided that it has been placed or installed in its intended normal position and they have been given supervision or instruction concerning use of the appliance in safe way and understand the hazards involved. Children aged from 3 years and less than 8 years shall not plug in, regulate and clean the appliance or perform user maintenance.
19. **CAUTION** – Some parts of this product can become very hot and cause burns. Particular attention has to be given where children and vulnerable people are present.
20. This product is fitted with a thermostatic room temperature control

### Location of Controls



1. Thermostat control knob ( **TEMPERATURE SETTING**)- Adjust to maintain room temperature
2. Flame switch - Switches flame effect and power on/off
3. Heating setting: please press “  ” for 1000W
4. Heating setting : please press “  ”and“  ”at the same time for 2000W (can not operate without first press“  ”)
5. Flame dimmer control - Adjust to set flame intensity

### Assembly Instructions

Lay stove upside down on a padded surface with the underside accessible. Attach leg to stove by inserting the tab on the top of the leg into the corresponding slot on the bottom of the stove. Insert screws into predrilled holes and tighten securely. Repeat with remaining three legs.

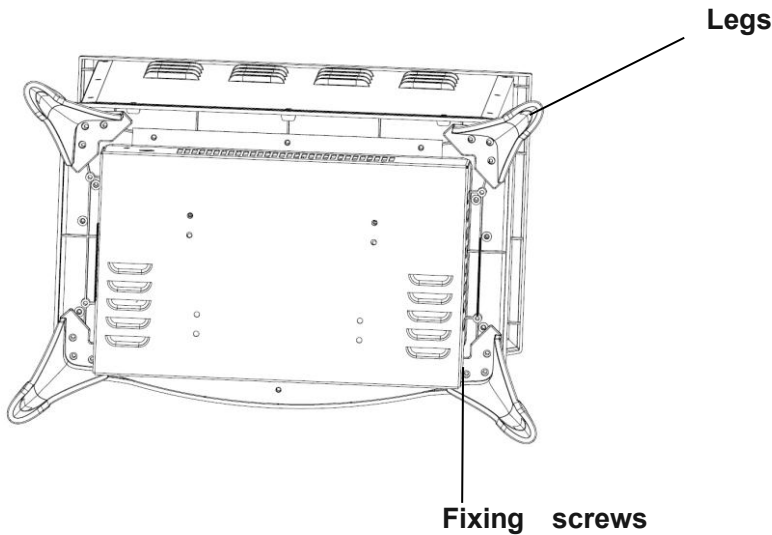

**Overheating safe device**

If the heater stops working, turn the heater off and inspect the blockage of inlet or outlet. **Disconnect the plug and wait at least 10 minutes** for the protection system to reset before attempting to restart the heater. If the safe device still switches the heater off and makes the heater fail to operate, take the heater to your nearest service center for examination or repair.

Attention: before restarting the heater, **the plug must be disconnected for at least 10 minutes**

**Table for information requirements for electric local space heaters**

Model identifier(s):YH-20-1B					
Item	Symbol	Value	Unit	Item	Unit
Heat output				Type of heat input, for electric storage local space heaters only (select one)	
Nominal heat output	Pnom	1.8-2.0	kW	Manual heat charge control with integrated thermostat	[no]
Minimum heat output (indicative)	Pmin	1.0	kW	Manual heat charge control with room and/or outdoor temperature feedback	[no]
Maximum continuous heat output	Pmax	2.0	kW	Electronic heat charge control with room and/or outdoor temperature feedback	[no]
Auxiliary electricity consumption				Fan assisted heat output	[no]
At nominal heat output	elmax	N/A	kW	Type of heat output/room temperature control (select one)	
At minimum heat output	elmin	N/A	kW	Single stage heat output and no room temperature control	[no]
In standby mode	eISB	N/A	W	Two or more manual stages, no room temperature control	[no]
				With mechanic thermostat room temperature control	[yes]

				With electronic room temperature control	[no]
				Electronic room temperature control plus day timer	[no]
				Electronic room temperature control plus week timer	[no]
				Other control options (multiple selections possible)	
				Room temperature control, with presence detection	[no]
				Room temperature control, with open window detection	[no]
				With distance control option	[no]
				With adaptive start control	[no]
				With working time limitation	[no]
				With black bulb sensor	[no]
Contact details:	IMPORTER ADDRESS: MH STAR UK LTD Unit 27, Perivale Park, Horsenden lane South Perivale, UB6 7RH MADE IN CHINA				
<b>Remark:</b> For electric local space heaters, the measured seasonal space heating energy efficiency $\eta_s$ cannot be worse than the declared value at the nominal heat output of the unit.					

### Cleaning

1. Always disconnect the appliance from the main supply before cleaning.
2. Clean the outside of the heater by wiping with a damp or dry cloth.
3. Do not use petroleum, any other detergent or chemical solvent to clean the heater.
4. When the heater is not used for a long time, it should be protected from dust and stored in a clean dry place.

### Disposal



#### Environmental Protection

Waste electrical production should not be disposed of with household waste. Please recycle where facilities exist. Check with your Local Authority or retailer for recycling advice.

If you have any questions, please contact our customer care center.  
Our contact details are below:

☎ 0044-800-240-4004

✉ enquiries@mhstar.co.uk

IMPORTER ADDRESS:  
 MH STAR UK LTD  
 Unit 27, Perivale Park,  
 Horsenden lane South  
 Perivale, UB6 7RH  
 MADE IN CHINA

