

PawHut

IN221101187V02_GL

D31-073V00

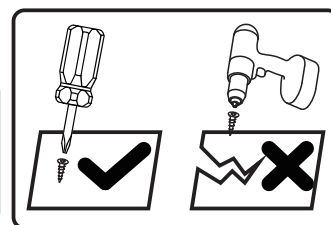
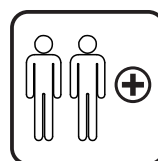
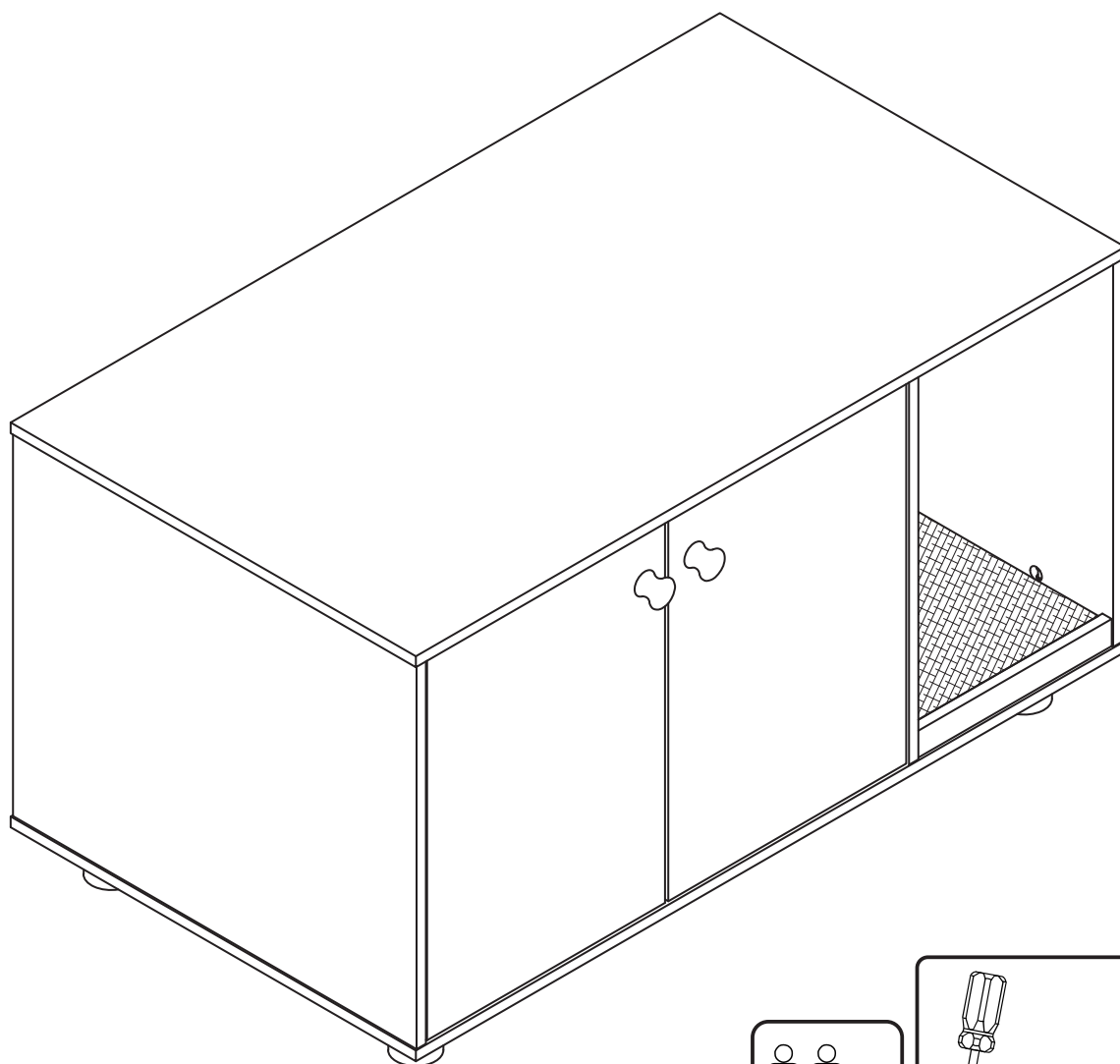

Tools Recommended

EN_IMPORTANT, RETAIN FOR FUTURE REFERENCE: READ CAREFULLY.

FR_IMPORTANT: A LIRE ATTENTIVEMENT ET À CONSERVER POUR CONSULTATION ULTÉRIEURE.

ES_IMPORTANTE, LEA Y GUARDE PARA FUTURAS REFERENCIAS.

PT_IMPORTANTE, RETER PARA REFERÊNCIA FUTURA: LEIA ATENTAMENTE.

DE_WICHTIG! SORGFÄLTIG LESEN UND FÜR SPÄTER NACHSCHLAGEN AUFBEWAHREN.

IT_IMPORTANTE! CONSERVARE IL PRESENTE MANUALE PER FUTURO RIFERIMENTO E LEGGERLO ATTENTAMENTE.

EN

Dear customer,

Thank you for purchasing this product. So that your appliance serves you well, please read all the instructions in this user's manual. If you have any questions, please contact our customer care center, Our contact details are below:

FR

Cher client,

Nous vous remercions d'avoir acheté ce produit. Afin que vous puissiez profiter pleinement de votre appareil, veuillez lire toutes les instructions de ce manuel d'utilisation. Si vous avez la moindre question, veuillez contacter notre centre d'assistance à la clientèle, Nos coordonnées sont les suivantes:

DE

Sehr geehrter Kunde,

Vielen Dank, dass Sie dieses Produkt erworben haben. Damit Ihr Gerät Ihnen gute Dienste leistet, lesen Sie bitte alle Hinweise in diesem Benutzerhandbuch. Wenn Sie Fragen haben, wenden Sie sich bitte an unser Kundendienstzentrum, Unsere Kontaktdaten stehen unten:

ES

Queridos clientes,

Gracias por comprar este producto. Para que su electrodoméstico le sirva mejor, lea todas las instrucciones de este manual del usuario. Si tiene alguna pregunta, comuníquese con nuestro Centro de Atención al Cliente, Nuestros datos de contacto son los siguientes:

PT



Caros clientes,

Obrigado por adquirir este produto. Para que o seu aparelho o sirva melhor, leia todas as instruções deste manual do utilizador. Se tiver alguma dúvida, por favor contacte o nosso Centro de Atendimento ao Cliente, Os nossos dados de contacto são os seguintes:

IT

Caro Cliente,

Grazie per aver acquistato questo prodotto. Per servirti meglio con questo apparecchio ti prego di leggere tutte le istruzioni in presente manuale utente. In caso di dubbio, si prega di contattare il nostro centro assistenza clienti, I nostri dettagli di contatto sono di seguito:

Country	 Phone	 Email
US	001-877-644-9366	customerservice@aosom.com
CA	416-792-6088	customerservice@aosom.ca
UK	0044-800-240-4004	enquiries@mhstar.co.uk
DE	0049-0(40)-88307530	service@aosom.de
FR	0033-1-84166106	aosom@mhfrance.fr
ES	0034-931294512	atencioncliente@aosom.es
PT	0034-931294512	info@aosom.pt
IT	0039-0249471447	clienti@aosom.it

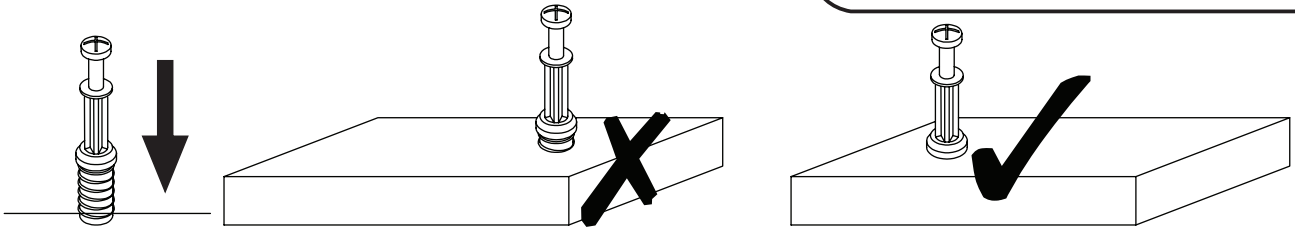

EN_QUICKFIT: Tighten quickfit until shoulder is flush with panel. Do not overtighten or undertighten.

FR_RACCORD RAPIDE: Faites serrer le raccord rapide jusqu'à ce que l'épaulement soit parfaitement encastré dans le panneau. Il ne faut ni trop serrer ni insuffisamment serrer.

ES_QUICKFIT: Apriete quickfit hasta que el hombro se descargue con el panel. NO lo sobreapriete ni lo apriete poco.

PT_AJUSTE RÁPIDO: Aperte o ajuste rápido até estar nivelada com o painel. Não apertar demasiado ou excessivamente.

DE_QUICKFIT: Ziehen Sie den Quickfit fest, bis die Schulter mit der Platte bündig ist. Bitte nicht zu fest oder zu schwach anziehen.

IT_MONTAGGIO RAPIDO: Stringere il montaggio rapido fino a quando la spalla è a filo con il pannello, non stringere troppo o troppo poco.

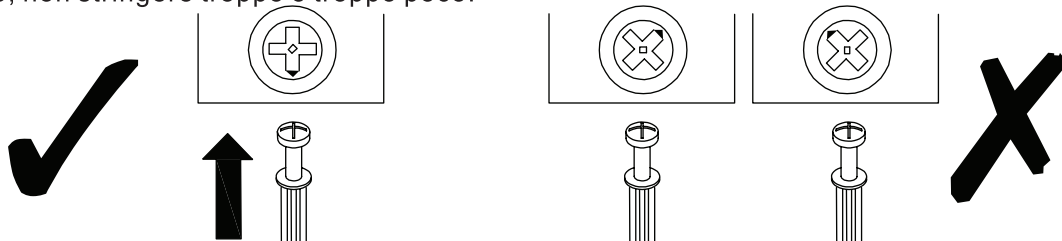

EN_CAM LOCK: When fitting cam lock, ensure starting position is correct before you insert connecting quickfit.

FR_SERRURE BATTEUSE: Avant d'insérer la serrure batteuse, veillez à la bonne orientation avant d'insérer le raccord rapide.

ES_CIERRE DE LA CÁMARA: Cuando instale el cierre de la cámara, asegúrese de que la posición de inicio es correcta antes de que inserte el quickfit conector.

PT_BLOQUEIO: Ao instalar o bloqueio, assegurar-se de que a posição inicial está correcta antes de inserir o encaixe de ligação rápida.

DE_CAM-LOCK: Achten Sie bei der Montage des Cam-Locks auf die richtige Ausgangsposition, bevor Sie den Quickfit einsetzen.

IT_BLOCCAGGIO A CAMMA: Quando si monta il bloccaggio a camma, assicurarsi che la posizione iniziale sia corretta prima di inserire il montaggio rapido di collegamento.

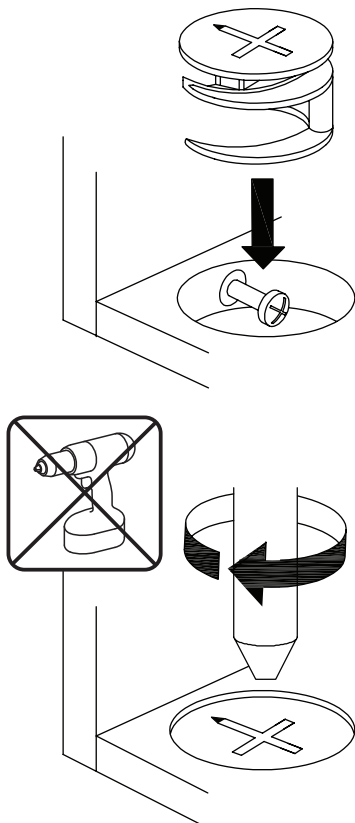

EN_Quickfit head should be in the centre of the cam lock when the two panels are joined.

Cam lock should be inserted before quickfit.

FR_Lorsque les deux panneaux sont assemblés, la tête du raccord rapide doit reposer au centre de la serrure batteuse.

Il faut insérer la serrure batteuse avant le raccord rapide.

ES_El cabezal del quickfit debe estar en el centro del cierre de la cámara cuando se unan los dos paneles.

Se debe insertar el cierre de la cámara antes que el quickfit.

PT_A cabeça de ajuste rápido deve estar no centro da fechadura quando os dois painéis estão unidos.

A fechadura de cames deve ser inserida antes de ser rápida.

DE_Der Quickfit-Kopf sollte sich in der Mitte des Cam-Locks befinden, wenn die beiden Platten zusammengefügt sind.

Der Cam-Lock sollte vor dem Quickfit eingesetzt werden.

IT_La testa del montaggio rapido deve trovarsi al centro del bloccaggio a camma quando i due pannelli sono uniti.

Il Bloccaggio a Camma deve essere inserito prima del montaggio rapido.

EN_Turn cam lock clockwise to tighten.

FR_Faites tourner la serrure batteuse dans le sens des aiguilles d'une montre pour la resserrer.

ES_Gire el cierre de la cámara en sentido horario para apretarlo.

PT_Rodar o bloqueio no sentido dos ponteiros do relógio para o apertar.

DE_Drehen Sie den Cam-Lock im Uhrzeigersinn, um ihn festzuziehen.





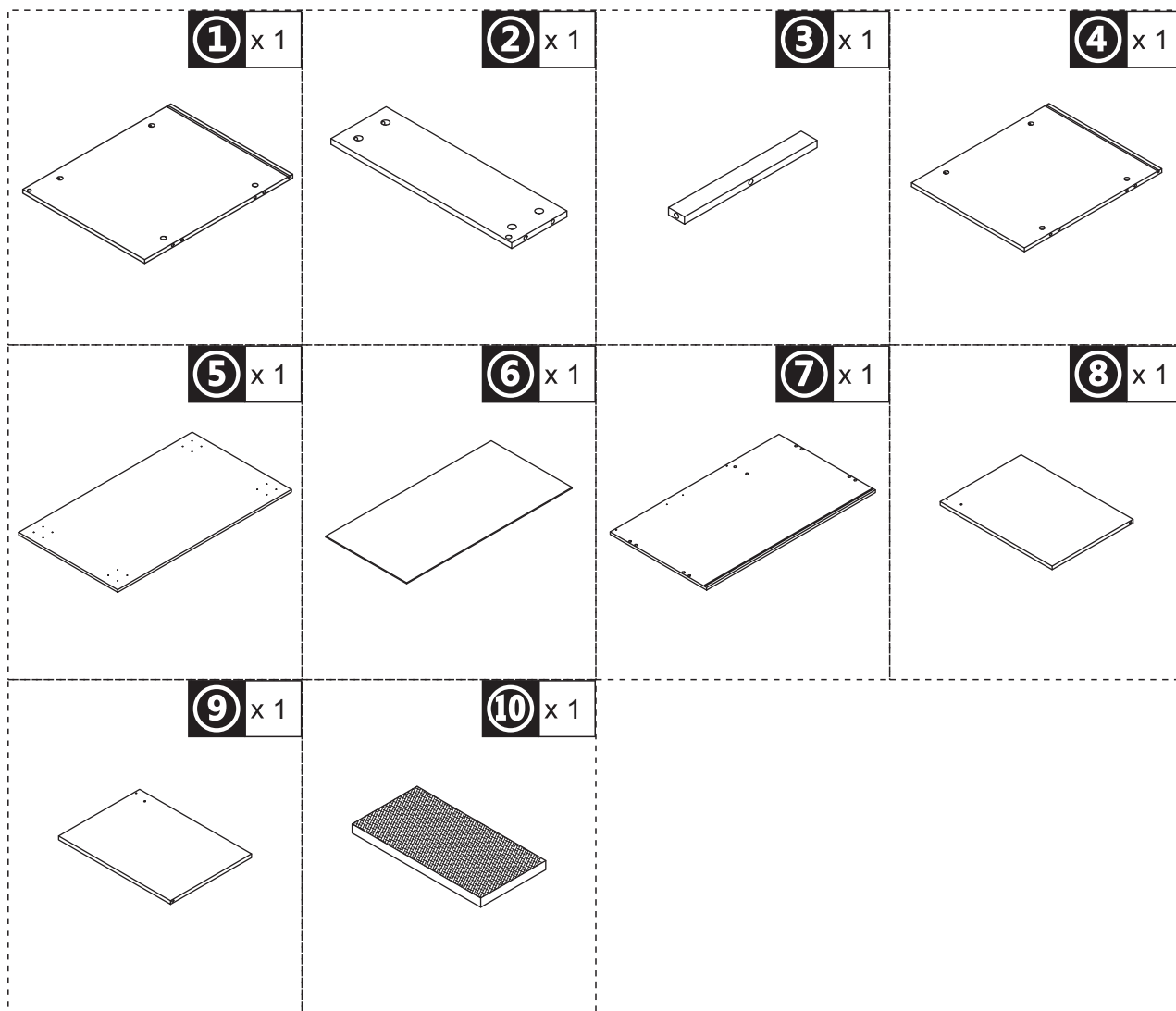



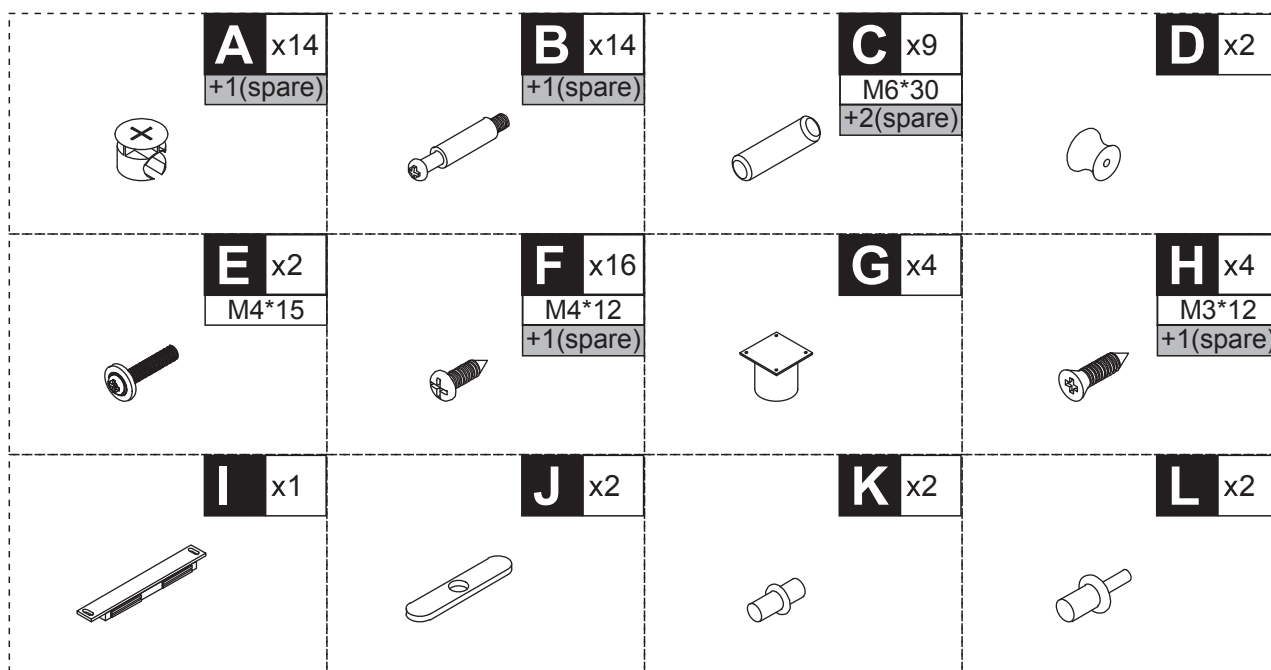

IT_Ruotare il bloccaggio a camma in senso orario per stringere.

PARTS



HARDWARE



-  BX14
-  CX9
-  DX2
-  EX2
-  FX16
-  GX4
-  HX4
-  IX1
-  JX2
-  KX2
-  LX2

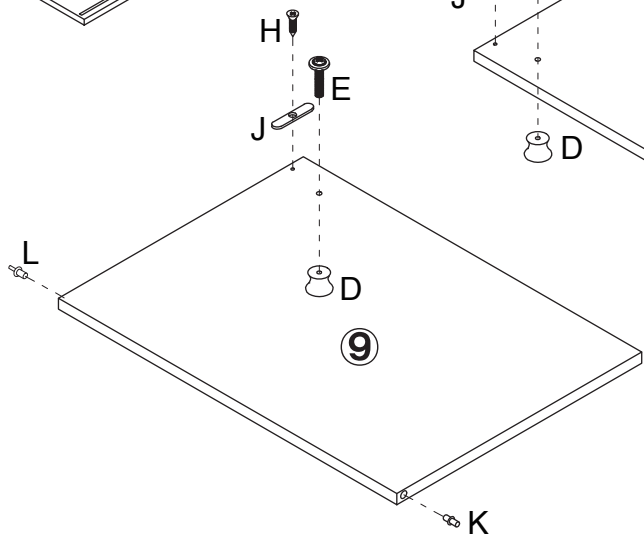
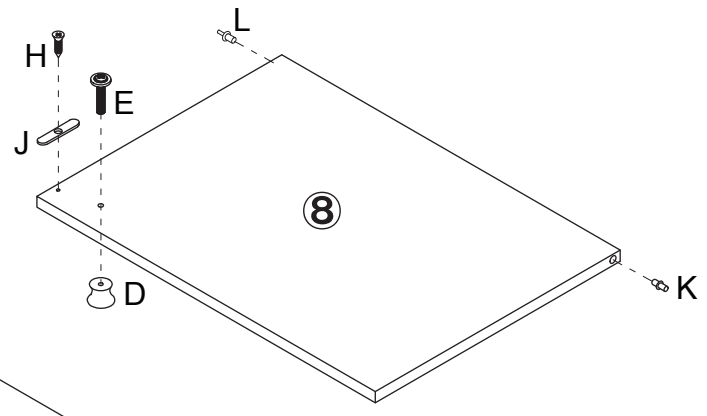
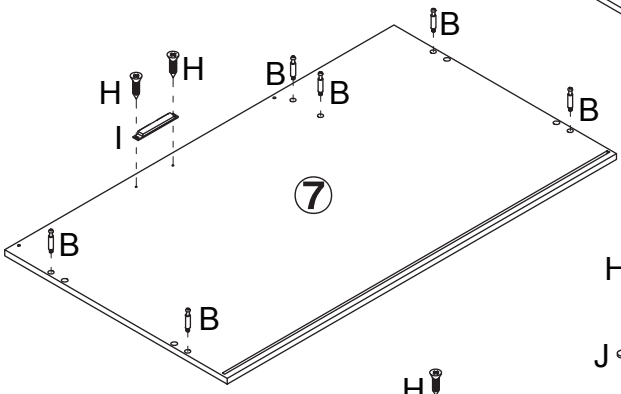
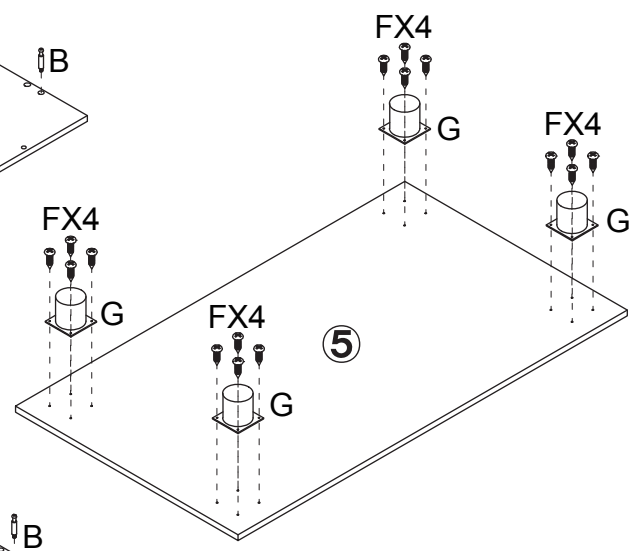
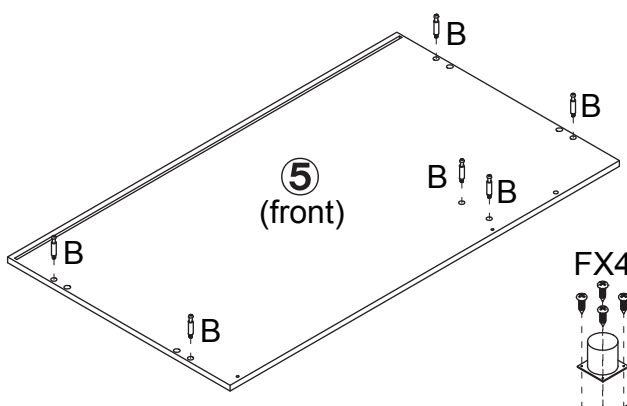
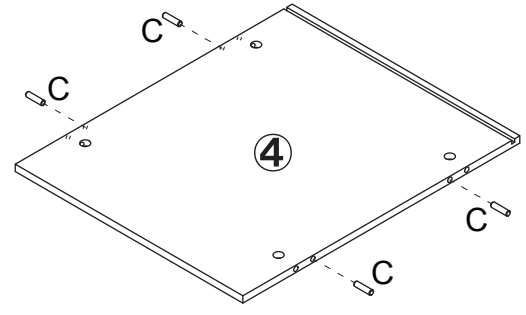
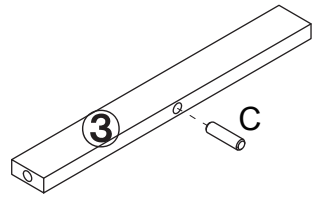
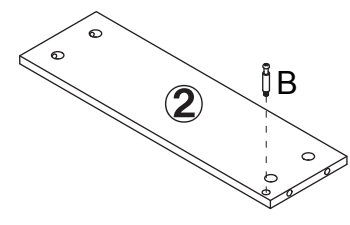
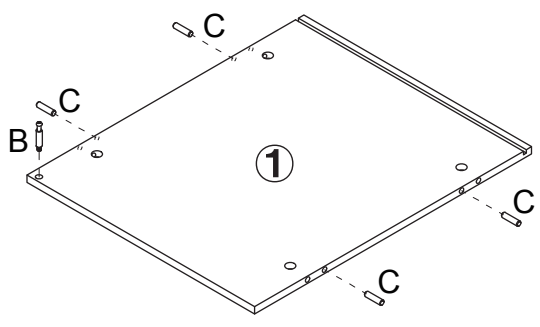

AX2

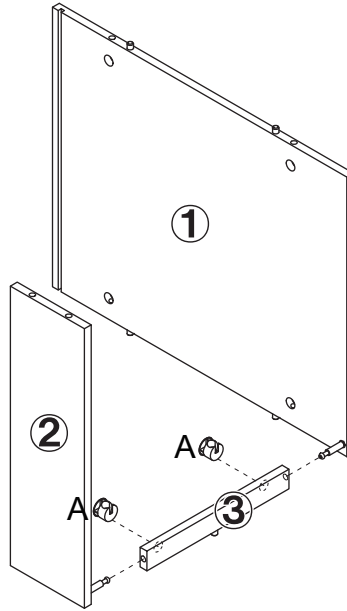

AX6

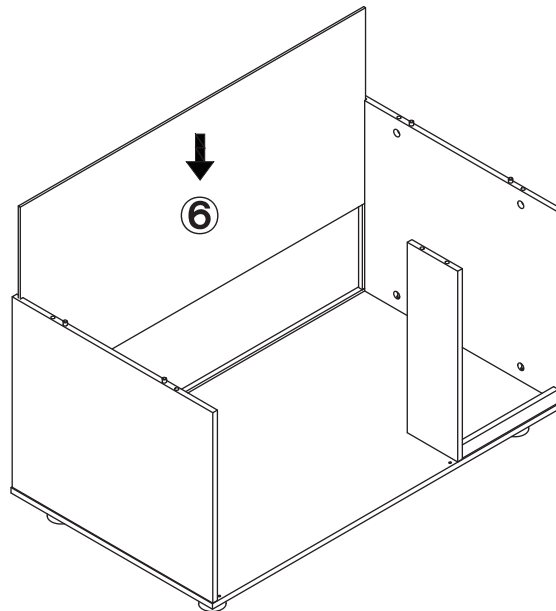
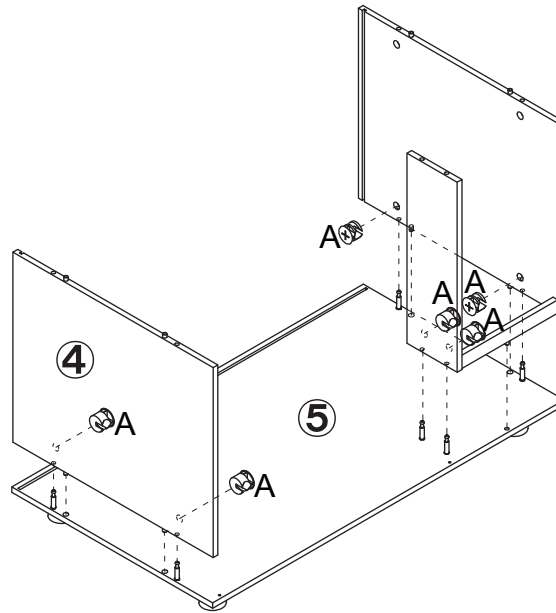

AX6

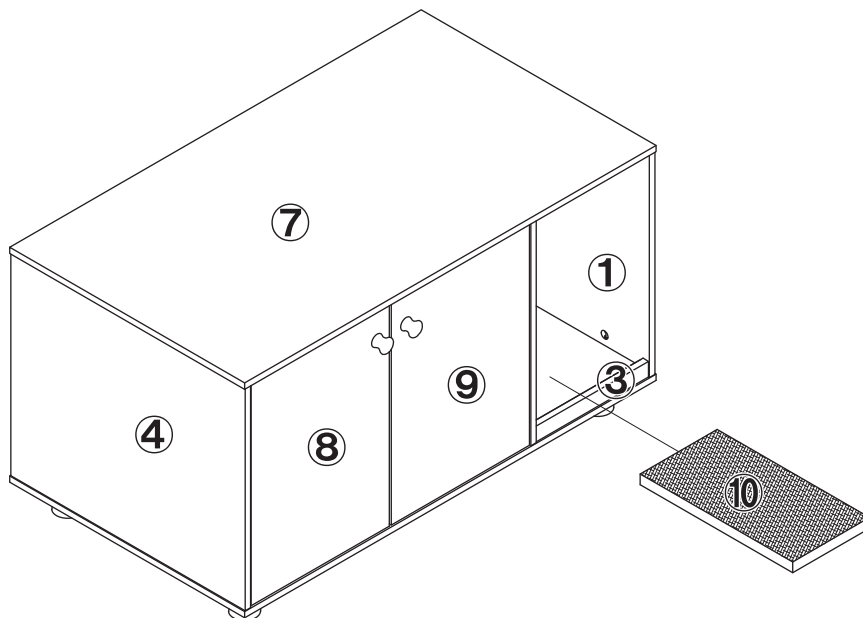
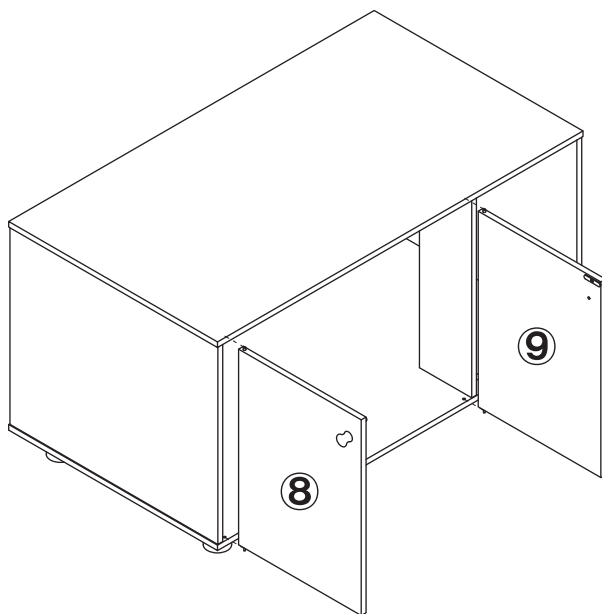
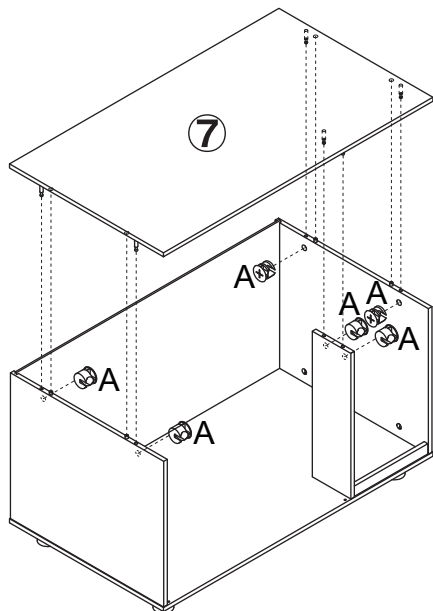

US

Imported by Aosom LLC
 27150 SW Kinsman Rd Wilsonville, OR 97070 USA
 MADE IN CHINA

CA

Imported by Aosom Canada Inc.
 7270 Woodbine Avenue, Unit 307, Markham, Ontario Canada
 L3R 4B9
 MADE IN CHINA

Importé par Aosom Canada Inc.
 7270 Woodbine Avenue, unité 307, Markham, Ontario Canada
 L3R 4B9
 Fabriqué en Chine

UK

IMPORTER ADDRESS:
 MH STAR UK LTD
 Unit 27, Perivale Park,
 Horsenden lane South
 Perivale, UB6 7RH
 MADE IN CHINA

FR

ADRESSE D'IMPORTATION:
 MH FRANCE
 2 Rue Maurice Hartmann
 92130 Issy Les Moulineaux
 France
 FABRIQUÉ EN CHINE

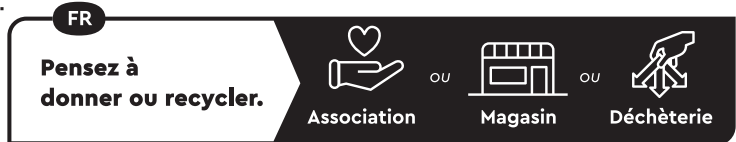

<https://quefairedemesdechets.fr>

ES

IMPORTADOR:
 SPANISH AOSOM, S.L.
 C/ROC GROS, Nº15.08550, ELS HOSTALET DE BALENYÀ, SPAIN.
 B66295775
 WWW.AOSOM.ES
 ATENCIONCLIENTE@AOSOM.ES
 TEL: 931294512
 HECHO EN CHINA

PT

SPANISH AOSOM, S.L
 C.ROC GROS N.15, 08550. ELS HOSTALET DE BALENYÀ
 TEL: 931294512 (SEG-SEX DAS 7:30H ÀS 16:30H)
 INFO@AOSOM.PT
 WWW.AOSOM.PT

DE

ADRESSE DES IMPORTEURE:
 MH Handel GmbH
 Wendenstraße 309
 D-20537 Hamburg
 Germany
 IN CHINA HERGESTELLT

IT

IMPORTATO DA:
 AOSOM Italy srl
 Centro Direzionale Milanofiori
 Strada 1 Palazzo F1
 20057 Assago (MI)
 P.I.: 08567220960
 FATTO IN CINA