

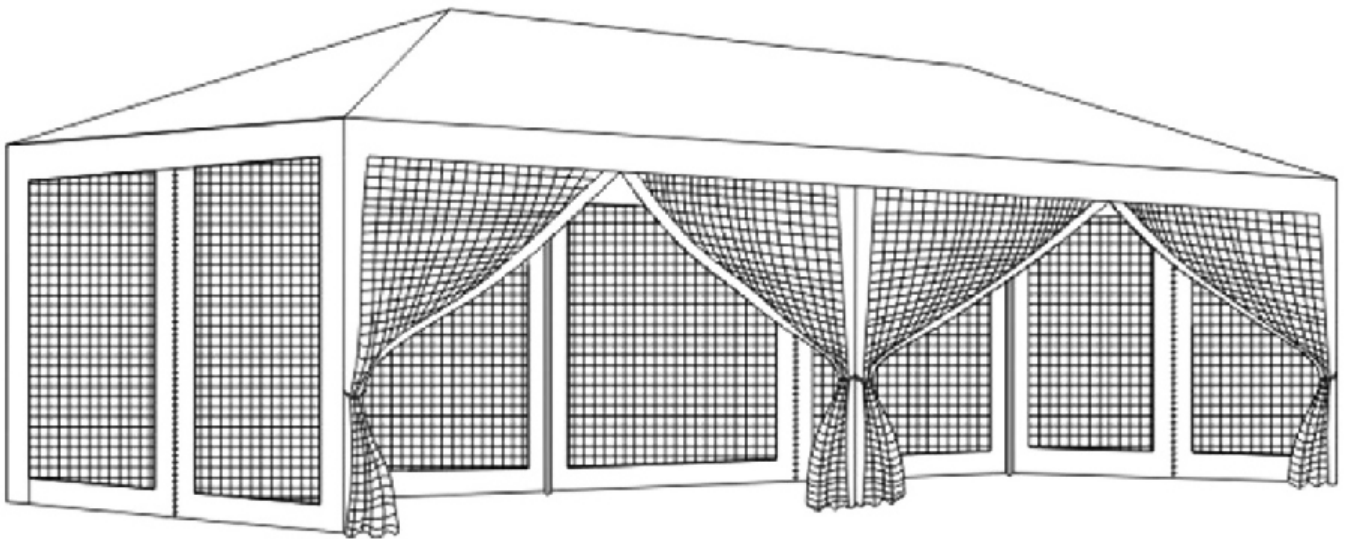

IN221200423V02_GL

840-012V02



EN_ IMPORTANT, RETAIN FOR FUTURE REFERENCE: READ CAREFULLY.

FR_ IMPORTANT: A LIRE ATTENTIVEMENT ET À CONSERVER POUR CONSULTATION ULTÉRIEURE.

ES_ IMPORTANTE, LEA Y GUARDE PARA FUTURAS REFERENCIAS.

PT_ IMPORTANTE, RETER PARA REFERÊNCIA FUTURA: LEIA ATENTAMENTE.

DE_ WICHTIG! SORGFÄLTIG LESEN UND FÜR SPÄTER NACHSCHLAGEN AUFBEWAHREN.

IT_ IMPORTANTE! CONSERVARE IL PRESENTE MANUALE PER FUTURO RIFERIMENTO E LEGGERLO ATTENTAMENTE.

WARNING

1. Find a flat and stable surface large enough to set up the folding pavilion. Carefully take the tent frame out of the bag and place it on a dry surface (sand, grass or firm surface).
2. Follow these instructions carefully to avoid getting your hands and fingers caught in the moving parts of the frame when opening and closing the frame. You need at least two people to safely assemble and dismantle the folding pavilion. Do not try to set up the tent by yourself, as pulling on one side can overload the tent legs and damage them unnecessarily. To avoid damage, the tent must be pulled out in tandem.
3. In windy conditions, secure the tent using the ropes attached to each side of the canopy. Attach the ropes to the pegs at a 30 degree angle and anchor them to the ground with a hammer. If the canopy is placed on a hard surface, secure the 4 sides with bricks or sandbags.
4. Do not set up the pavilion in windy weather conditions. This can lead to injuries and / or damage to your tent.
5. Do not use chemical additives to clean the roofs and side walls. The water temperature can be a maximum of 30°C.
6. Make sure that you pack the folding tent dry and store it upright in the bag provided in a dry place. A damp tent can get mold stains.
7. No liability is accepted for damage caused by improper storage or cleaning.
8. Please take appropriate actions as heavy rain, wind and snow can damage the tent. If necessary please dis -assemble and store for later use.
9. In snowy conditions please do not allow the thickness of the snow to be more than 5cm on the roof, this should be cleared as soon as possible for your safety.

Avertissement

1. Trouvez une surface plane et stable assez grande et installez le pavillon pliant. Rerirez soigneusement le cadre de la tente du sac et placez-le sur une surface sèche (sable, herbe ou surface ferme).
2. Suivez attentivement ces instructions pour éviter d'attraper vos mains et vos doigts dans les parties mobiles du cadre lors de l'ouverture et de la fermeture du cadre. Vous avez besoin d'au moins deux personnes pour assembler et démonter en toute sécurité le pavillon pliant. N'essayez pas de mettre en place la tente par vous-même, car tirer sur un côté peut surcharger les jambes de la tente et les endommager inutilement. Pour éviter les dommages, la tente doit être retirée en tandem.
3. Par temps venteux, fixez la tente à l'aide des cordes fixées de chaque côté de l'auvent. Attachez les cordes aux chevilles à un angle de 30 degrés, et ancrez-les au sol à l'aide d'un marteau. Si l'auvent est placé sur une surface dure, fixez les 4 côtés avec des briques ou des sacs de sable.
4. N'installez pas le pavillon par temps venteux. Cela peut entraîner des blessures et/ ou des dommages à votre tente.
5. N'utilisez pas d'additifs chimiques pour nettoyer les toits et les parois latérales. La température de l'eau peut être maximale de 30 °C.
6. Veillez à emballer la tente pliante sèche et à la ranger debout dans le sac fourni dans un endroit sec. Une tente humide peut obtenir des taches de moisissure.
7. Aucune responsabilité n'est acceptée pour les dommages causés par un stockage ou un nettoyage inadéquat
8. Veuillez faire attention lorsque vous utilisez la serre en périodes de fortes pluies, vent ou neige : la serre pourrait être endommagée. Si nécessaire, veuillez démonter la serre afin de pouvoir la réutiliser plus tard.
9. Pour votre sécurité, en période de neige, il est recommandé de ne pas laisser de neige de plus de 5cm sur le toit.

ADVERTENCIA

1. Encuentre una superficie plana y estable que es suficientemente grande para instalar la carpa plegable. Saque el marco de la carpa de la bolsa cuidadosamente y colóquelo sobre una superficie seca (arena, césped o superficie firme).
2. Siga estas instrucciones cuidadosamente para evitar que sus manos y dedos se queden atrapados en las partes móviles del marco cuando usted abre y cierra el marco. Se necesita al menos dos personas para montar y desmontar la carpa plegable seguramente. No intente montar la carpa usted mismo, ya que tirar de un lado puede sobrecargar las patas de la carpa y dañarlas innecesariamente. Para evitar daños, la carpa debe ser extraída en tándem.
3. En condiciones de viento, fije la carpa con las cuerdas unidas a cada lado de la carpa. Sujete las cuerdas a las clavijas en un ángulo de 30 grados y fíjelas al suelo con el martillo. Si la carpa se coloca sobre una superficie dura, fije los 4 lados con ladrillos o sacos de arena.
4. No instale la carpa en condiciones de viento, si no, se puede provocar lesiones y / o daños a su carpa.
5. No utilice los aditivos químicos para limpiar los techos y paredes laterales. La temperatura del agua no puede exceder a 30°C.
6. Asegúrese de empacar la carpa plegable en seco y guardarla verticalmente en la bolsa provista en un lugar seco. Una carpa húmeda puede manchar de moho.
7. No se acepta responsabilidad por los daños causados por almacenamiento o limpieza inadecuados.
8. Por favor, tome las medidas oportunas ya que la lluvia, el viento y la nieve pueden dañar la tienda. Si es necesario, desmonte la tienda y guárdela para su uso posterior.
9. En condiciones de nieve, no permita que la nieve tenga más de 5 cm de espesor en el techo, y retírela tan pronto como sea posible para su seguridad.

ATENÇÃO

1. Encontrar uma superfície plana e estável suficientemente grande para montar a tenda dobrável. Tirar cuidadosamente a estrutura da tenda do saco e colocá-la sobre uma superfície seca (areia, relva ou superfície firme).
2. Siga cuidadosamente estas instruções para evitar ficar com as mãos e os dedos presos nas partes móveis da estrutura ao abrir e fechar a estrutura. São necessárias pelo menos duas pessoas para montar e desmontar a tenda dobrável em segurança. Não tente montar a tenda sozinho, pois puxar de um lado pode sobrecarregar as pernas da tenda e danificá-las desnecessariamente. Para evitar danos, a tenda deve ser puxada em simultâneo.
3. Em condições de vento, prenda a tenda usando as cordas fixadas a cada lado do toldo. Fixar as cordas às estacas num ângulo de 30 graus e ancorá-las ao chão com um martelo. Se o toldo for colocado sobre uma superfície dura, fixar os 4 lados com tijolos ou sacos de areia.
4. Não montar a tenda em condições climáticas de vento. Isto pode levar a lesões e/ou danos na sua tenda.
5. Não utilizar aditivos químicos para limpar a parte superior e as paredes laterais. A temperatura da água pode ser de um máximo de 30°C.
6. Assegure-se de que embala a tenda dobrável a seco e de que a guarda em pé no saco fornecido num local seco. Uma tenda húmida pode ficar com manchas de bolor.
7. Não é aceite qualquer responsabilidade por danos causados por armazenamento ou limpeza impróprios.
8. Tome medidas adequadas, em caso de vento forte, chuva ou neve, pois estas podem danificar a tenda. Caso seja necessário, desmonte e armazene a tenda de campismo para uso posterior.
9. Em caso de neve, não permita que a espessura da neve seja superior a 5cm no teto. Para a sua segurança, retire a neve o mais rápido possível

WARNUNG

1. Suchen Sie eine Ebene und stabile Fläche, die groß genug ist, um den Faltpavillon darauf aufzubauen. Nehmen Sie vorsichtig das Zelt-Gestell aus der Tasche und legen es auf eine trockene Oberfläche (Sand, Gras oder feste Oberfläche).
2. Befolgen Sie diese Anleitung sorgfältig, um Ihre Hände und Finger beim Öffnen und Schließen des Rahmens, nicht in die beweglichen Teile des Rahmens einzuklemmen. Um den Faltpavillon sicher auf- und abzubauen, benötigen Sie mindestens zwei Personen. Versuchen Sie nicht, das Zelt alleine aufzustellen, da einseitiges Ziehen die Zeltbeine überlasten kann und diese dadurch unnötig beschädigt werden. Um Beschädigungen zu vermeiden, muss das Zelt im Tandem ausgezogen werden.
3. Bei windigen Wetterverhältnissen, befestigen Sie das Zelt unter der Verwendung der Seile, die an jeder Seite der Dachhaube angebracht sind. Befestigen Sie die Seile in einem 30 Grad Winkel an den Heringen die Sie mit Hilfe eines Hammers im Boden verankern. Falls die Dachhaube auf einer harten Oberfläche platziert wurde, sichern Sie die 4 Seiten mit Ziegelsteinen oder Sandsäcken ab.
4. Bauen Sie den Faltpavillon nicht bei windigen Wetter-Verhältnissen auf. Dabei kann es zu Verletzungen und/oder Schäden an Ihrem Zelt kommen.
5. Verwenden Sie keine chemischen Zusätze für das Reinigen der Dächer und Seitenwände. Das Wasser darf maximal 30° C warm sein.
6. Achten Sie darauf, dass Sie das Falzelt trocken einpacken und aufrecht in der dafür vorgesehenen Tasche an einem trockenen Platz aufbewahren. Ein noch feuchtes Zelt kann Stockflecken bekommen.
7. Für entstandene Schäden durch unsachgemäße Lagerung oder Reinigung wird keine Haftung übernommen.
8. Bitte ergreifen Sie geeignete Maßnahmen, da starker Regen, Wind und Schnee das Zelt beschädigen können. Falls nötig, bauen Sie es bitte ab und bewahren Sie es zur späteren Verwendung auf.
9. Bei Schneefall darf die Schneehöhe auf dem Dach nicht mehr als 5 cm betragen, diese sollte zu Ihrer Sicherheit so schnell wie möglich beseitigt werden.

AVVERTENZE

1. Scegliere una superficie piana, stabile e abbastanza spaziosa per l'allestimento del padiglione pieghevole. Estrarre con cautela il telaio della tenda dal borsone e posizionarlo su una superficie asciutta (sabbia, erba o altre superfici solide).
2. Seguire attentamente queste istruzioni per evitare che mani e dita vengano intrappolate nelle parti mobili del telaio durante l'apertura e la chiusura dello stesso. Per montare e smontare in sicurezza il padiglione pieghevole sono necessarie almeno due persone adulte. Non tentare di montarlo da solo, in quanto tirare con forza da un lato può sovraccaricare le gambe del tendone e danneggiarle inutilmente. Per evitare di danneggiarlo, estrarlo in due.
3. In caso di forti venti, fissare il tendone con le corde posizionate su ciascun lato. Fissare le corde ai pioli con un angolo di 30 gradi e ancorarli al suolo con il martello. Se il tendone viene posizionato su una superficie molto dura, i 4 lati vanno fissati con mattoni o sacchi di sabbia.
4. Non allestire il padiglione in caso di forti venti, in quanto ciò potrebbe portare a lesioni a voi stesso e / o danni al tendone.
5. Non utilizzare additivi chimici per pulire la parte superiore e i lati del tendone. La temperatura dell'acqua utilizzata per la pulizia può essere al massimo di 30°C.
6. Assicurarsi di ripiegare il tendone pieghevole e riporlo asciutto in posizione verticale nel borsone e in un luogo asciutto. Il tendone umido può macchiarsi di muffa.
7. Si declina ogni responsabilità per danni causati da una conservazione o pulizia impropria del prodotto.
8. Si prega di prendere le precauzioni necessaria in quanto pioggia, vento e neve possono danneggiare la tenda. Se necessario si prega di smontarla e conservarla per uso futuro.
9. Qualora nevicasse si prega di non lasciare che lo strato di neve sopra la tenda sia spesso oltre i 5cm, anzi la neve va rimossa al più presto per la vostra sicurezza.

A x 1



G x 6



B x 1



H x 6

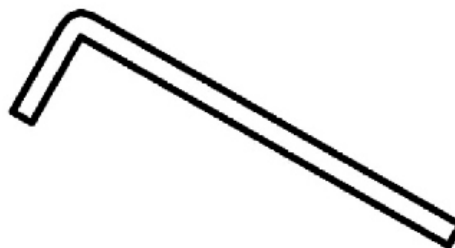

C x 1



D x 6



A x 1

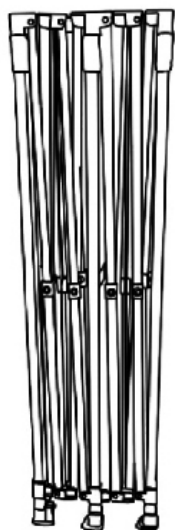

A



A

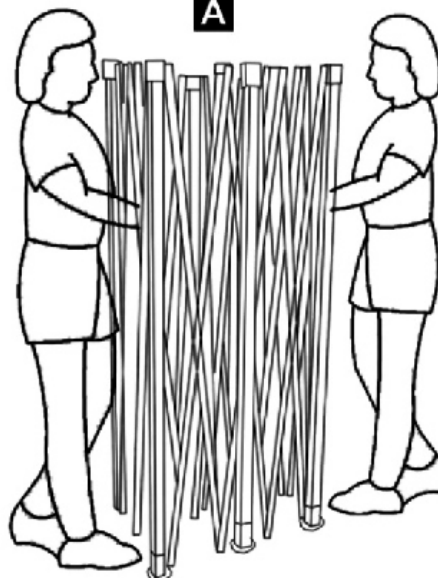

02

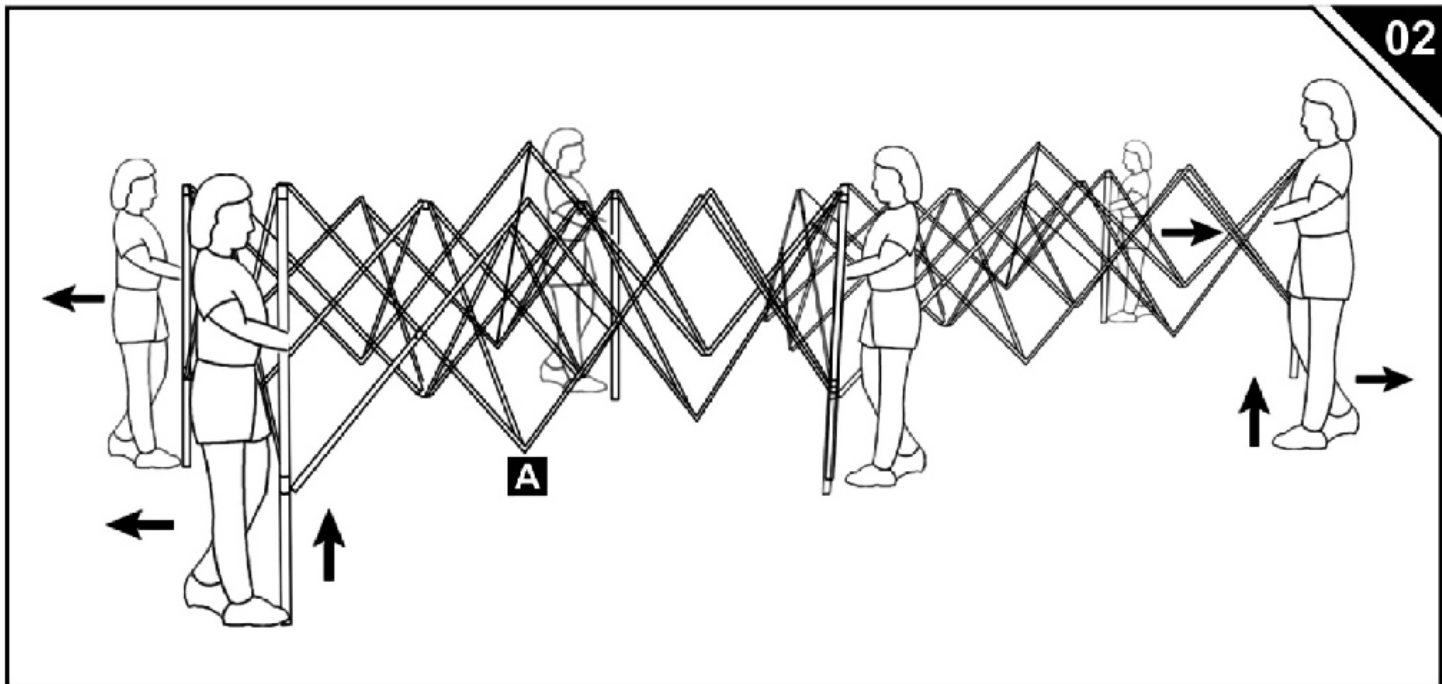

03

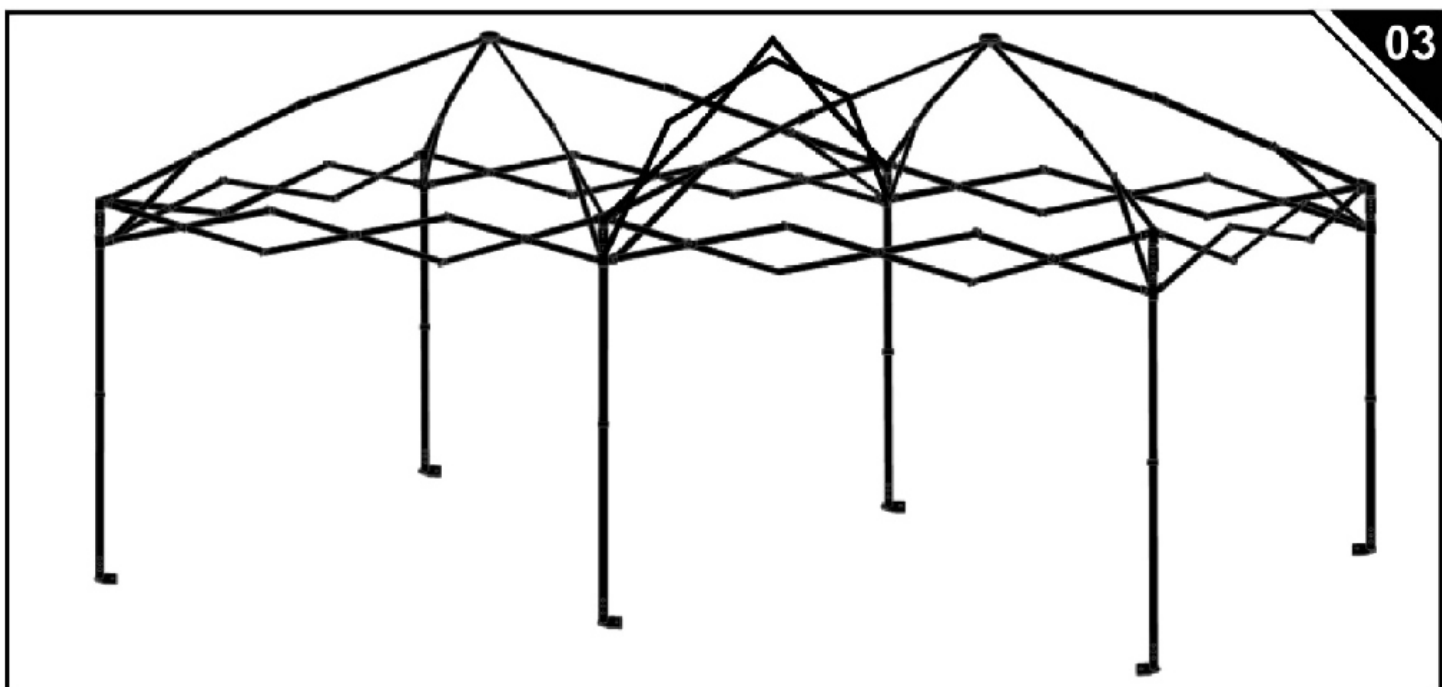

B x 1

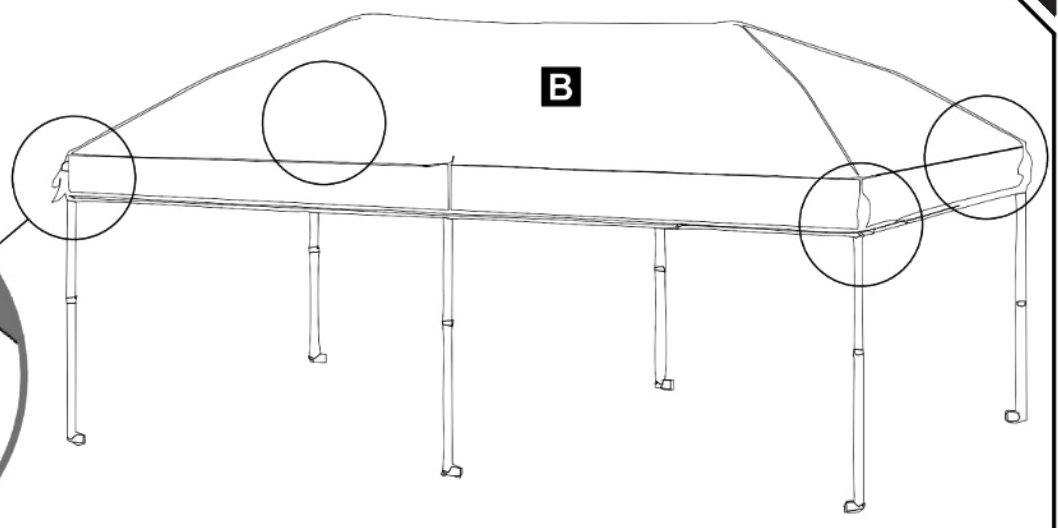
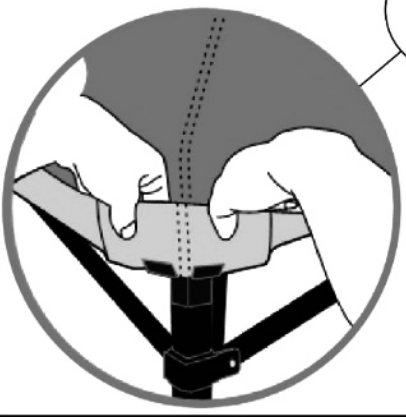
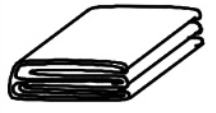

1

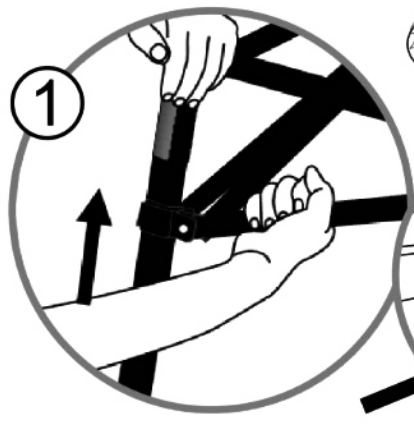

2

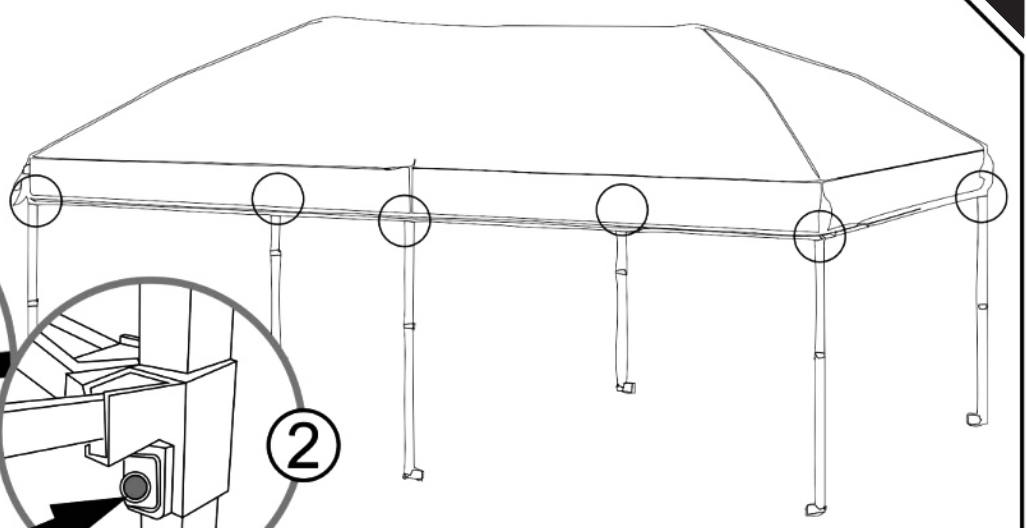
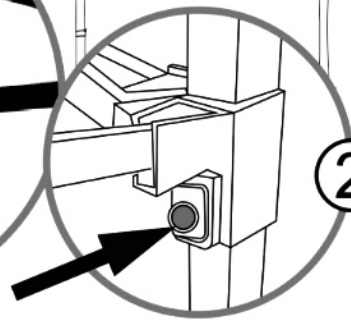

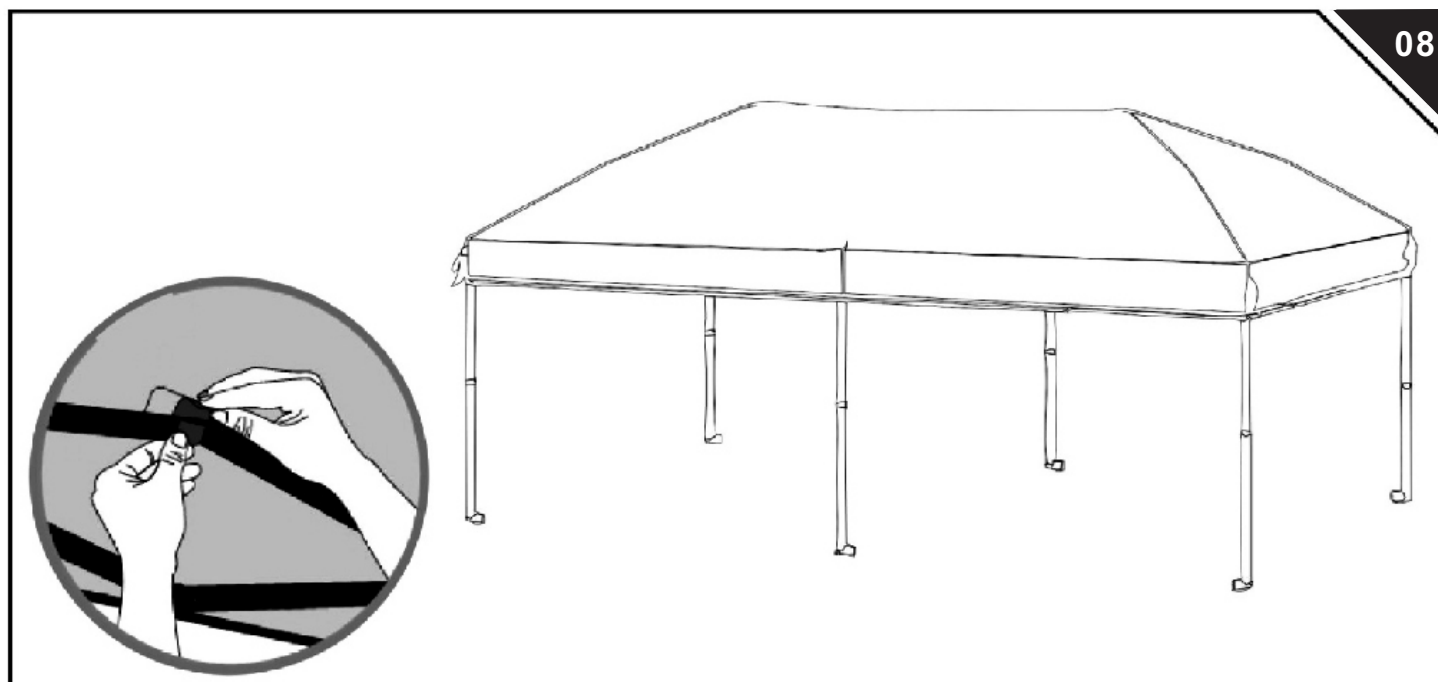
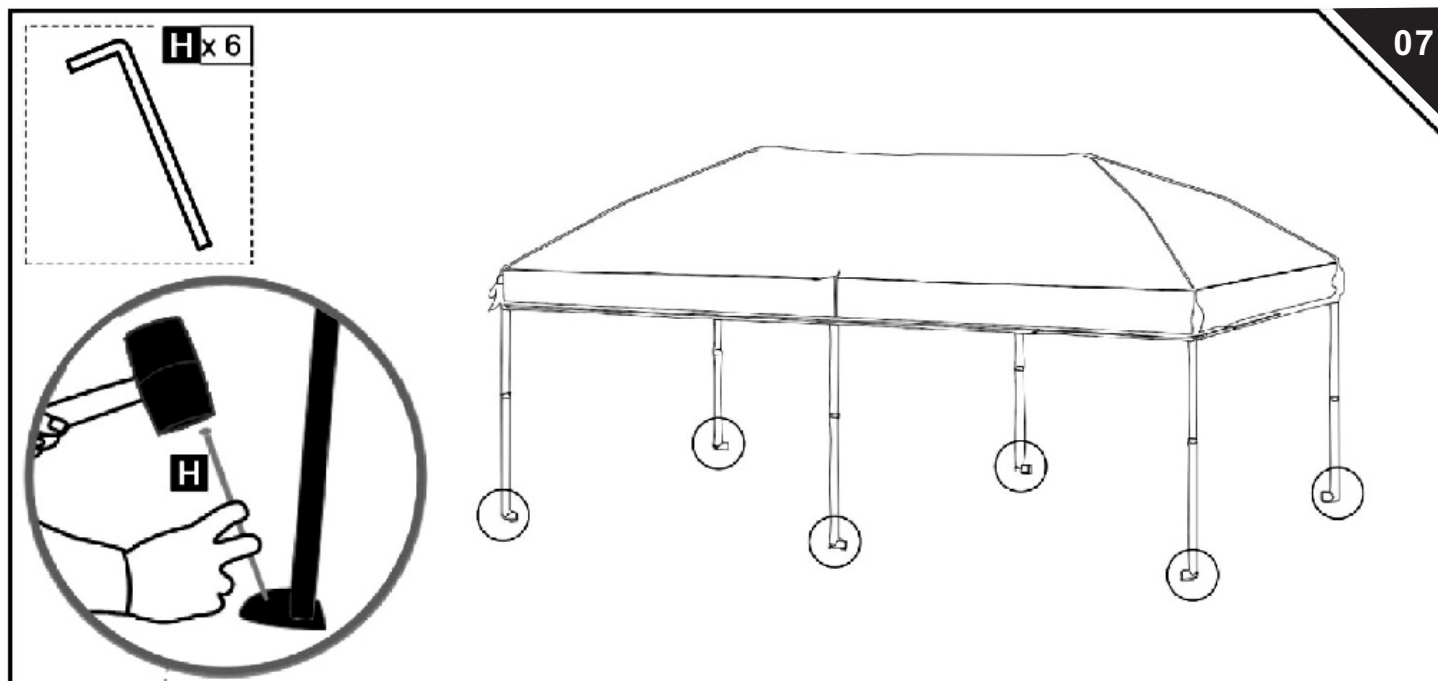
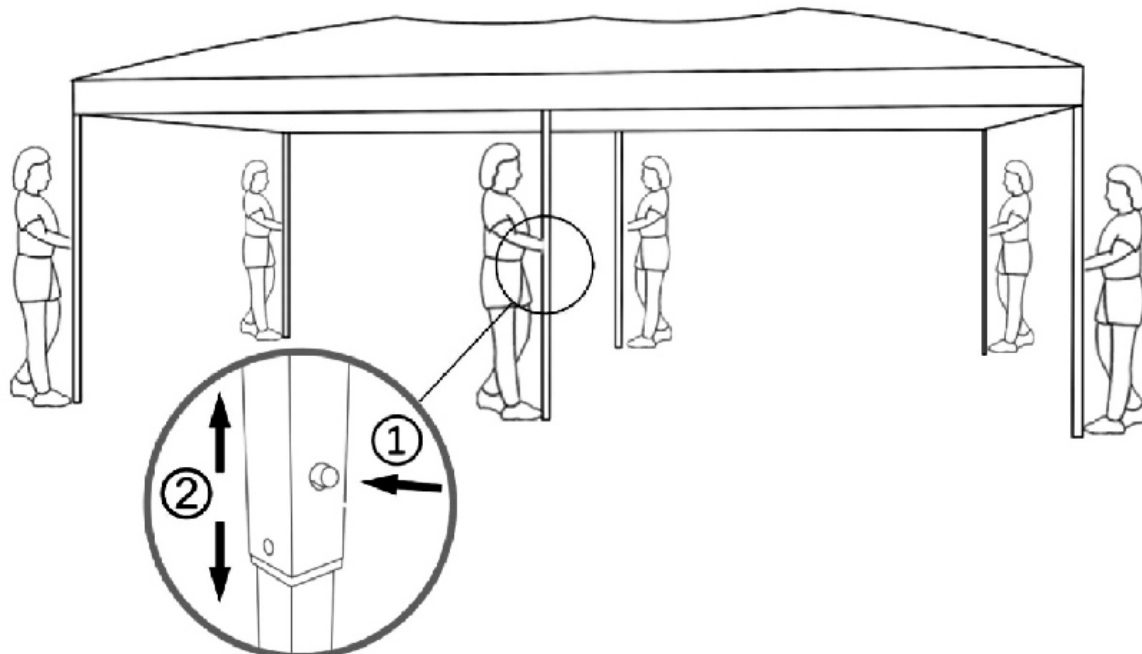

C X1

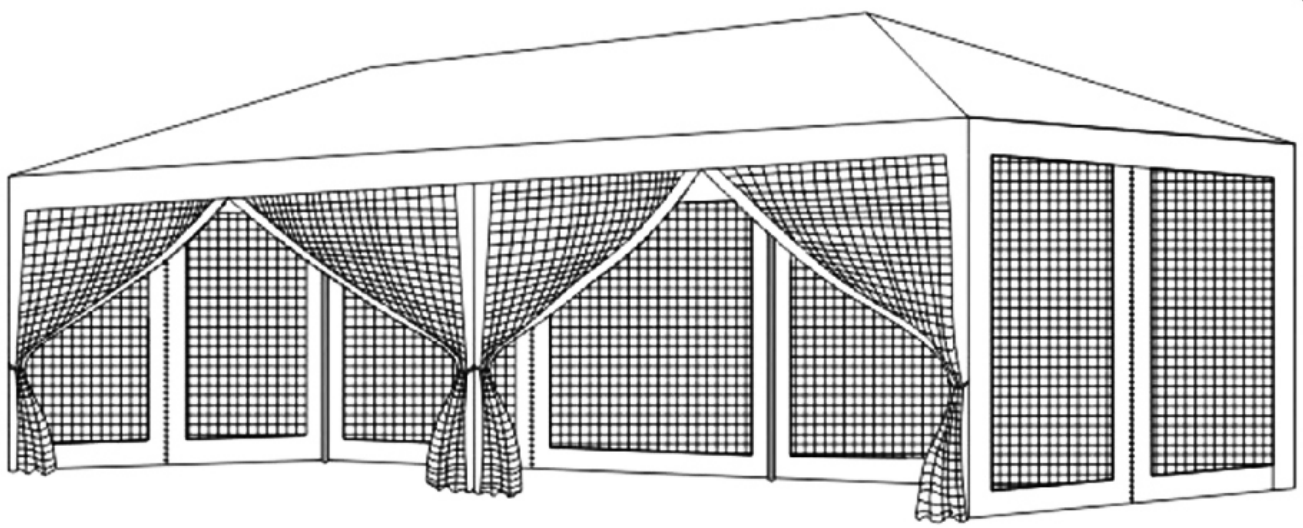
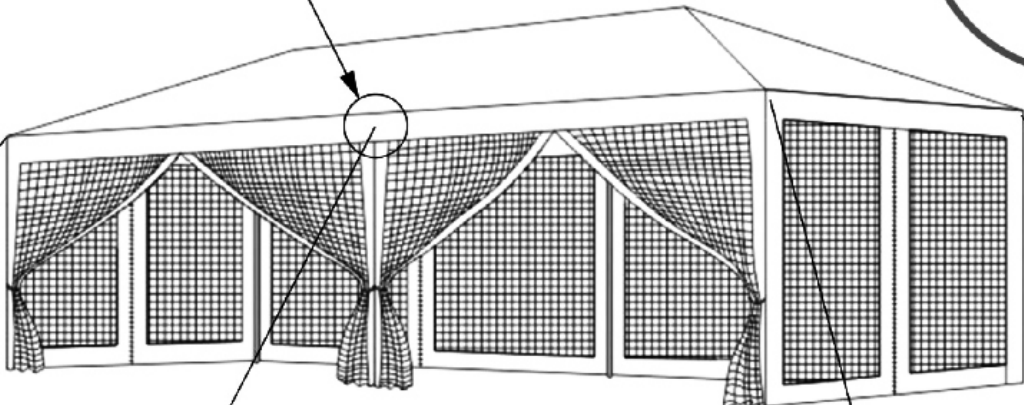
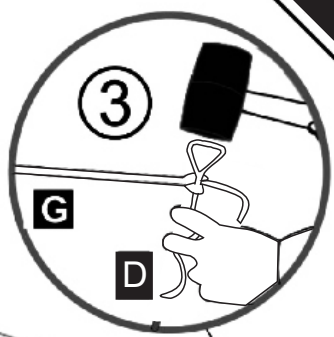
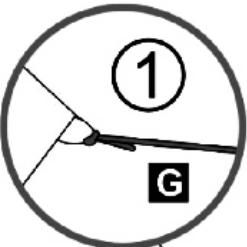
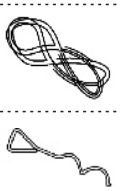
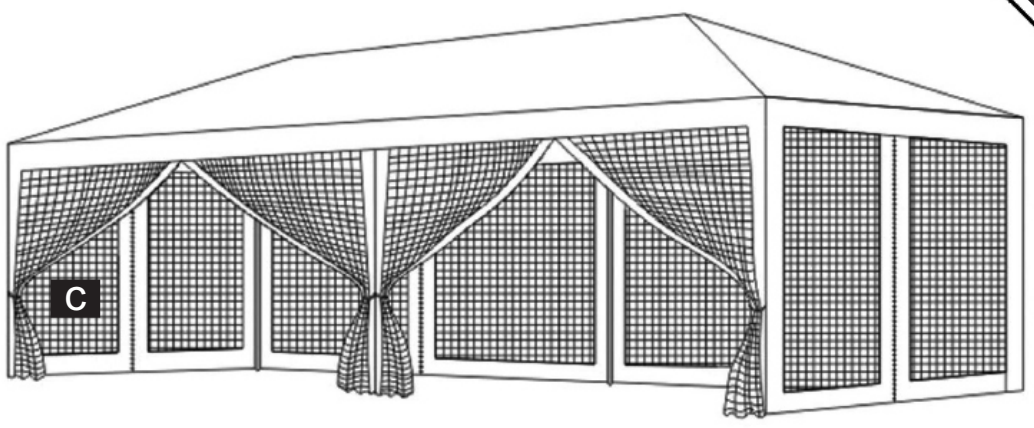

If you have any questions, please contact our customer care center.

Our contact details are below:

 001-877-644-9366

 customerservice@aosom.com

Imported by Aosom LLC

27150 SW Kinsman Rd Wilsonville, OR 97070 USA

MADE IN CHINA

US

Si tiene alguna pregunta, comuníquese con nuestro Centro de Atención al Cliente.

Nuestros datos de contacto son los siguientes:

 0034-931294512

 atencioncliente@aosom.es

IMPORTADOR:

SPANISH AOSOM, S.L.

C/ ROC GROS, Nº 15. 08550, ELS HOSTALETES DE BALENYÀ, SPAIN.

B66295775

WWW.AOSOM.ES

HECHO EN CHINA

ES

If you have any questions, please contact our customer care center.

Our contact details are below:

 416-792-6088

 customerservice@aosom.ca

Imported by Aosom Canada Inc.

7270 Woodbine Avenue, Unit 307, Markham,

Ontario Canada L3R 4B9

MADE IN CHINA

CA

Se tiver alguma dúvida, por favor contacte o nosso Centro de Atendimento ao Cliente.

Os nossos dados de contacto são os seguintes:

 0034-931294512 (SEG-SEX DAS 7:30H ÀS 16:30H)

 info@aosom.pt.

IMPORTADOR:

SPANISH AOSOM, S.L

C.ROC GROS N.15, 08550. ELS HOSTALETES DE BALENYÀ

WWW.AOSOM.PT

PT

Si vous avez la moindre question, veuillez contacter notre centre d'assistance à la clientèle.

Nos coordonnées sont les suivantes:

 416-792-6088

 customerservice@aosom.ca

Importé par Aosom Canada Inc.

7270 Woodbine Avenue, unité 307,

Markham, Ontario Canada L3R 4B9

Fabriqué en Chine

DE

Wenn Sie Fragen haben, wenden Sie sich bitte an unser Kundendienstzentrum.

Unsere Kontaktdaten stehen unten:

 0049-0(40)-88307530  service@aosom.de

ADRESSE DES IMPORTEURS:

MH Handel GmbH

Wendenstraße 309

D-20537 Hamburg

Germany

IN CHINA HERGESTELLT

DE

If you have any questions, please contact our customer care center.

Our contact details are below:

 0044-800-240-4004

 enquiries@mhstar.co.uk

IMPORTER ADDRESS:

MH STAR UK LTD

Unit 27, Perivale Park,

Horsenden lane South

Perivale, UB6 7RH

MADE IN CHINA

UK

In caso di dubbio, si prega di contattare il nostro centro assistenza clienti.

I nostri dettagli di contatto sono di seguito:

 0039-0249471447  clienti@aosom.it

IMPORTATO DA:

AOSOM Italy srl

Centro Direzionale Milanofiori

Strada 1 Palazzo F1

20057 Assago (MI)

P.I.: 08567220960

FATTO IN CINA

IT

Si vous avez la moindre question, veuillez contacter notre centre d'assistance à la clientèle.

Nos coordonnées sont les suivantes:  0033-1-84166106  aosom@mhfrance.fr

Importé par: MH France 2, rue Maurice Hartmann 92130 Issy-les-Moulineaux

Fabriqué en Chine

France

FR



FR

**DONNEZ
OU
RECYCLEZ**



OU



OU



ASSOCIATION LIVRAISON DÉCHÈTERIE

Adresses sur quefairedemesdechets.fr