

**EN\_IMPORTANT, RETAIN FOR FUTURE REFERENCE: READ CAREFULLY.**

**FR\_IMPORTANT: A LIRE ATTENTIVEMENT ET À CONSERVER POUR CONSULTATION ULTÉRIEURE.**

**ES\_IMPORTANTE, LEA Y GUARDE PARA FUTURAS REFERENCIAS.**

**PT\_IMPORTANTE, RETER PARA REFERÊNCIA FUTURA: LEIA ATENTAMENTE.**

**DE\_WICHTIG! SORGFÄLTIG LESEN UND FÜR SPÄTERES NACHSCHLAGEN AUFBEWAHREN.**

**IT\_IMPORTANTE! CONSERVARE IL PRESENTE MANUALE PER FUTURO RIFERIMENTO E LEGGERLO ATTENTAMENTE.**

## IF HAVE THIS ACCESSORY

NOTE DIFFERENT MODELS

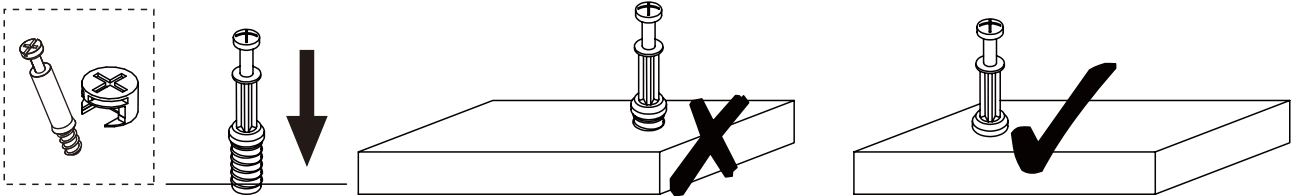

**EN\_QUICKFIT:** Tighten quickfit until shoulder is flush with panel. Do not overtighten or undertighten.

**FR\_RACCORD RAPIDE:** Faites serrer le raccord rapide jusqu'à ce que l'épaulement soit parfaitement encastré dans le panneau. Il ne faut ni trop serrer ni insuffisamment serrer.

**ES\_QUICKFIT:** Apriete quickfit hasta que el hombro se descargue con el panel. NO lo sobreapriete ni lo apriete poco.

**PT\_AJUSTE RÁPIDO:** Aperte o ajuste rápido até estar nivelada com o painel. Não apertar demasiado ou excessivamente.

**DE\_QUICKFIT:** Ziehen Sie den Quickfit fest, bis die Schulter mit der Platte bündig ist. Bitte nicht zu fest oder zu schwach anziehen.

**IT\_MONTAGGIO RAPIDO:** Stringere il montaggio rapido fino a quando la spalla è a filo con il pannello, non stringere troppo o troppo poco.

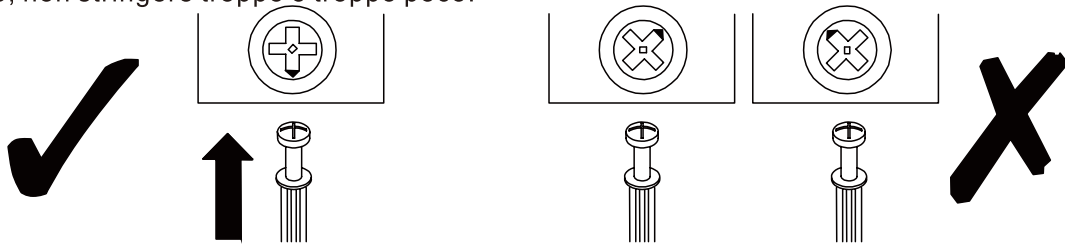

**EN\_CAM LOCK:** When fitting cam lock, ensure starting position is correct before you insert connecting quickfit.

**FR\_SERRURE BATTEUSE:** Avant d'insérer la serrure batteuse, veillez à la bonne orientation avant d'insérer le raccord rapide.

**ES\_CIERRE DE LA CÁMARA:** Cuando instale el cierre de la cámara, asegúrese de que la posición de inicio es correcta antes de que inserte el quickfit conector.

**PT\_BLOQUEIO:** Ao instalar o bloqueio, assegurar-se de que a posição inicial está correcta antes de inserir o encaixe de ligação rápida.

**DE\_CAM-LOCK:** Achten Sie bei der Montage des Cam-Locks auf die richtige Ausgangsposition, bevor Sie den Quickfit einsetzen.

**IT\_BLOCCAGGIO A CAMMA:** Quando si monta il bloccaggio a camma, assicurarsi che la posizione iniziale sia corretta prima di inserire il montaggio rapido di collegamento.

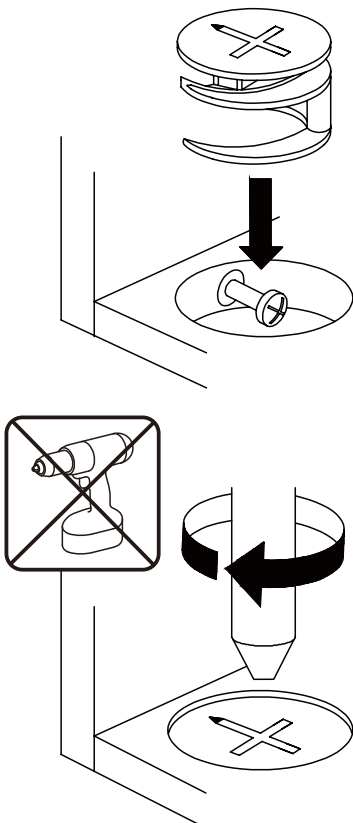

**EN\_Quickfit head** should be in the centre of the cam lock when the two panels are joined.

Cam lock should be inserted before quickfit.

**FR\_**Lorsque les deux panneaux sont assemblés, la tête du raccord rapide doit reposer au centre de la serrure batteuse.

Il faut insérer la serrure batteuse avant le raccord rapide.

**ES\_**El cabezal del quickfit debe estar en el centro del cierre de la cámara cuando se unan los dos paneles.

Se debe insertar el cierre de la cámara antes que el quickfit.

**PT\_**A cabeça de ajuste rápido deve estar no centro da fechadura quando os dois painéis estão unidos.

A fechadura de cames deve ser inserida antes de ser rápida.

**DE\_**Der Quickfit-Kopf sollte sich in der Mitte des Cam-Locks befinden, wenn die beiden Platten zusammengefügt sind.

Der Cam-Lock sollte vor dem Quickfit eingesetzt werden.

**IT\_**La testa del montaggio rapido deve trovarsi al centro del bloccaggio a camma quando i due pannelli sono uniti.

Il Bloccaggio a Camma deve essere inserito prima del montaggio rapido.

**EN\_**Turn cam lock clockwise to tighten.

**FR\_**Faites tourner la serrure batteuse dans le sens des aiguilles d'une montre pour la resserrer.

**ES\_**Gire el cierre de la cámara en sentido horario para apretarlo.

**PT\_**Rodar o bloqueio no sentido dos ponteiros do relógio para o apertar.

**DE\_**Drehen Sie den Cam-Lock im Uhrzeigersinn, um ihn festzuziehen.

**IT\_**Ruotare il bloccaggio a camma in senso orario per stringere.

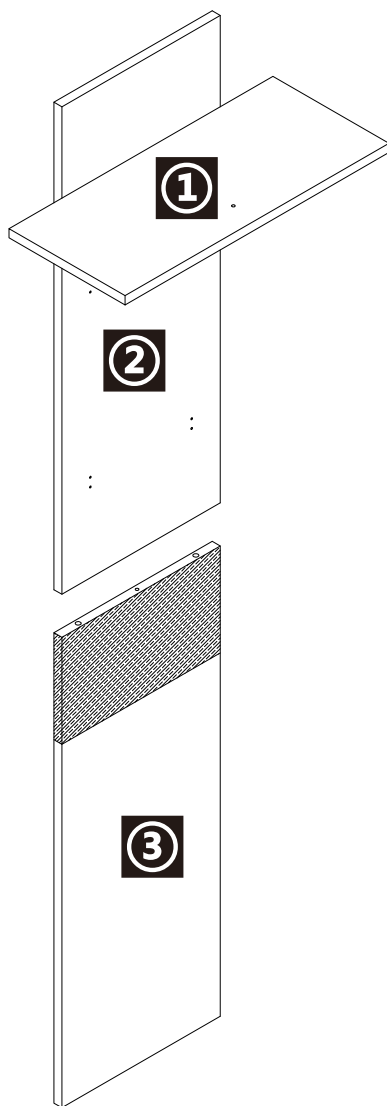

HARDWARE

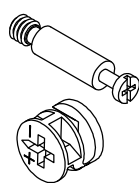

**A** x 1

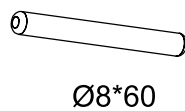

**B** x 2

Ø8\*60

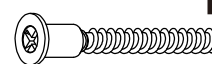

**C** x 2

M7\*50



**D** x 28

M3.5\*14

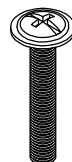

**E** x 2

M4\*30



**F** x 4

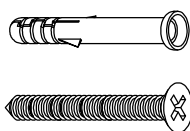

**G** x 4

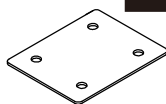

**H** x 2

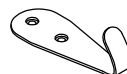

**I** x 4



**J** x 1

$A*1+B*2$

01

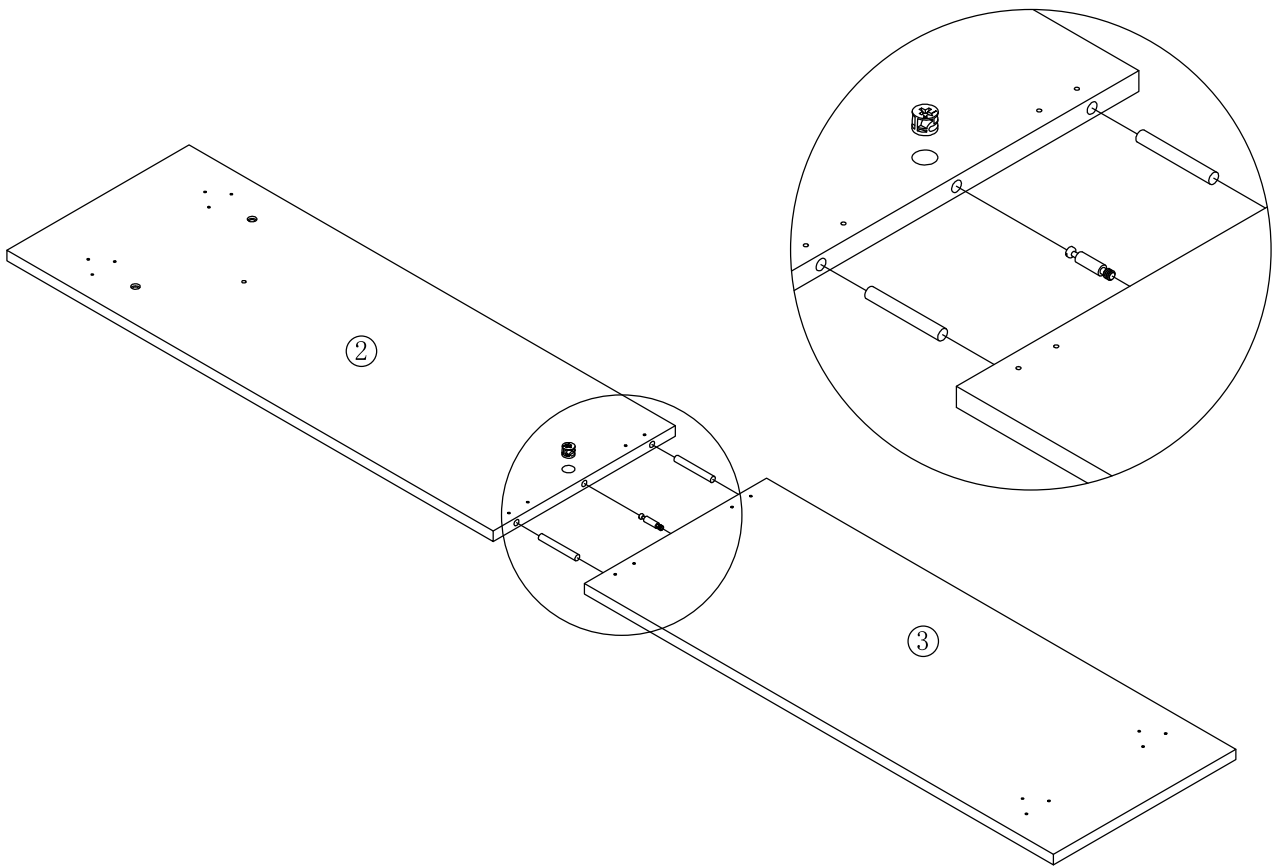

$D*20+F*4+H*2$

02

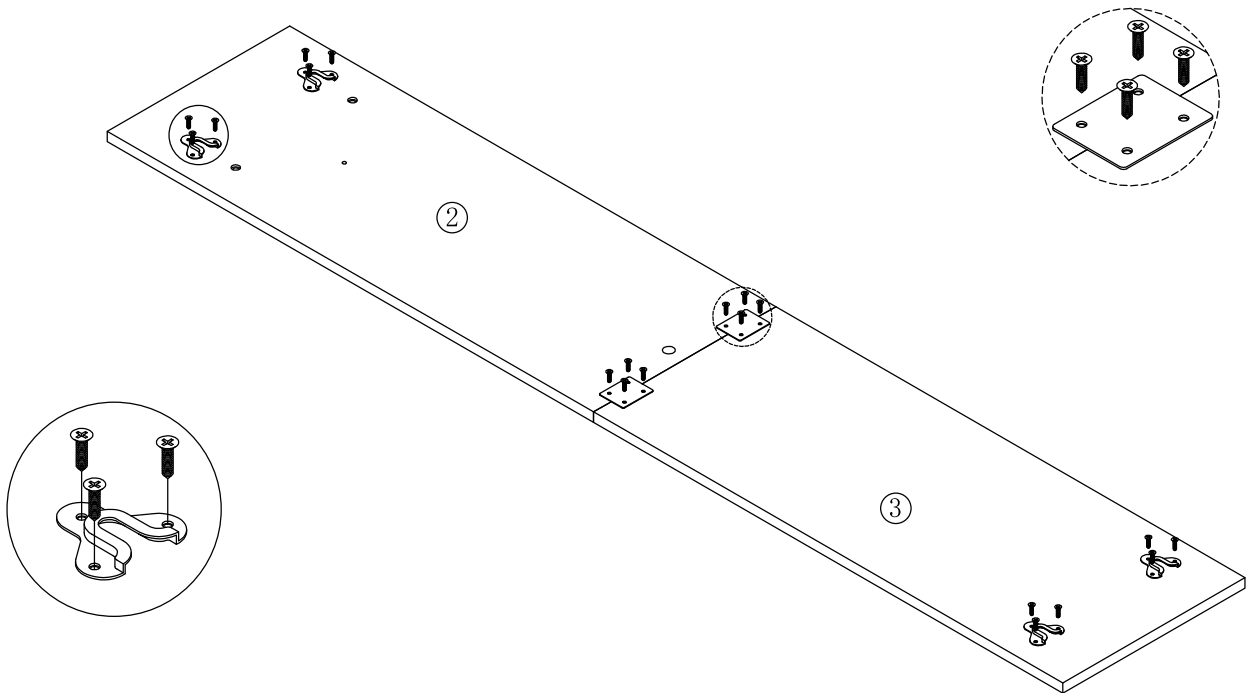

E\*1+J\*1

03

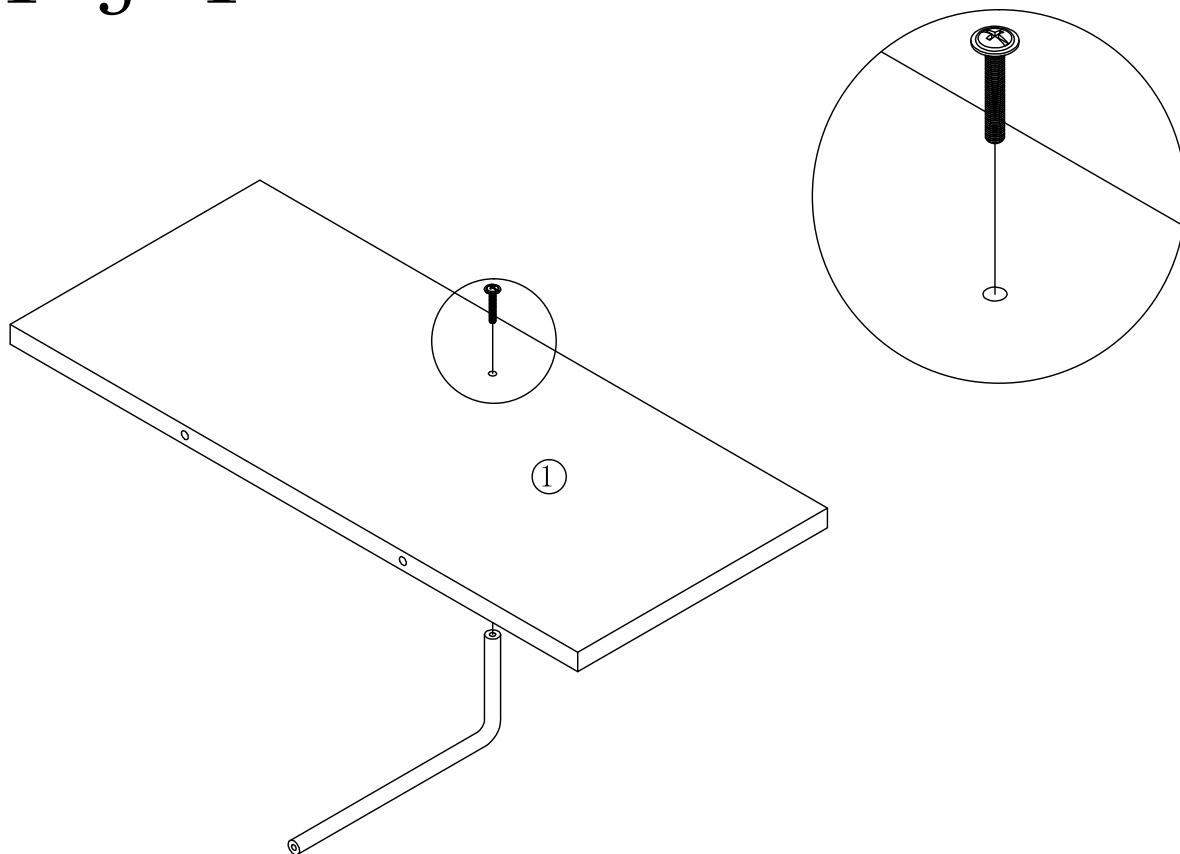

C\*2+E\*1

04

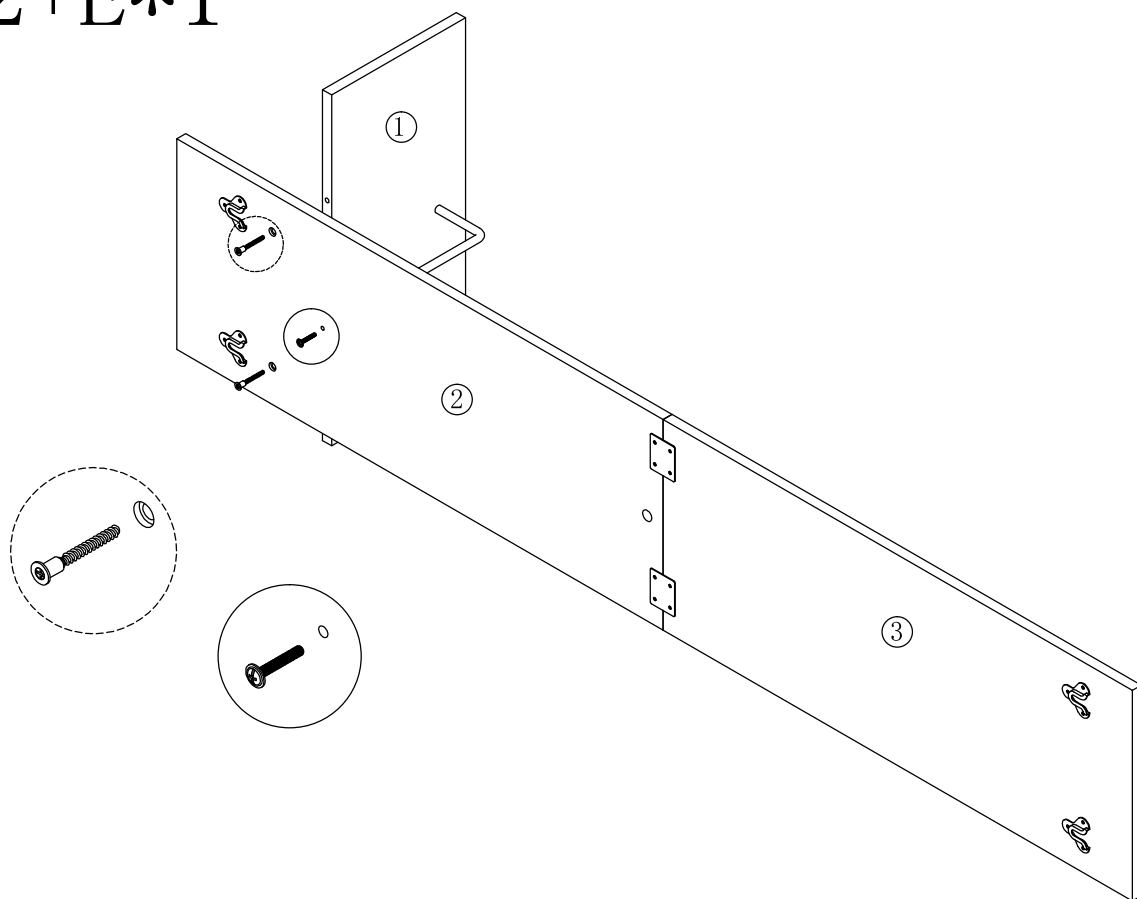

# D\*8+I\*4

05

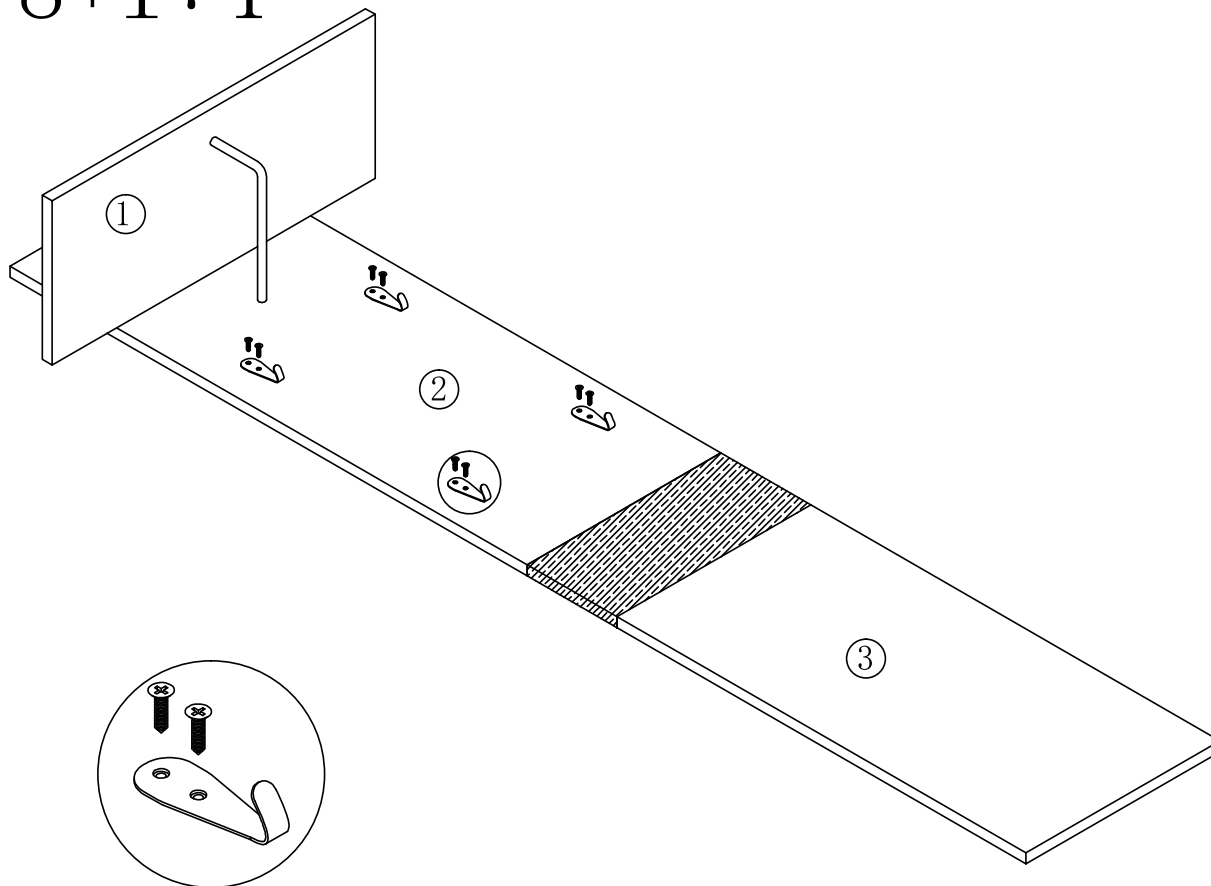

# G\*4

06

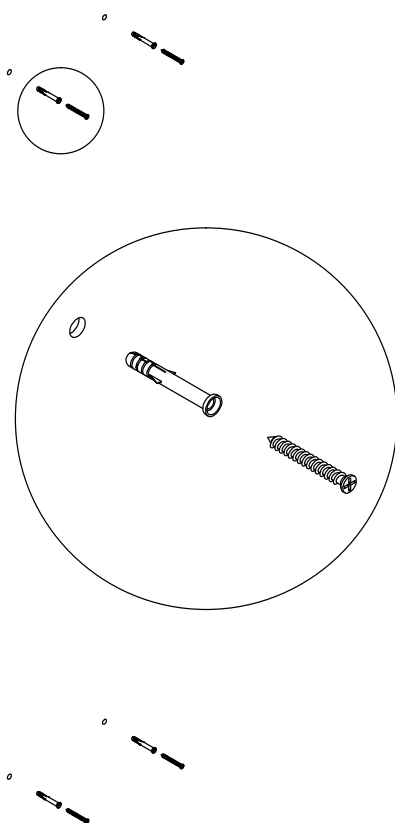

**EN** If it is a solid wall, please use expansion and self-tapping screws, if it is a wooden wall, only use self-tapping screws, please do not overtighten the screws

**FR** Si le mur est massif, veuillez utiliser des chevilles à expansion et des vis autotaraudeuses, mais s'il s'agit d'un mur en bois, utilisez uniquement des vis autotaraudeuses et ne serrez pas trop les vis.



**ES** Para una pared sólida, utilice los tornillos de expansión y autorroscantes. Para una pared de madera, utilice exclusivamente los tornillos autorroscantes, no los apriete demasiado.

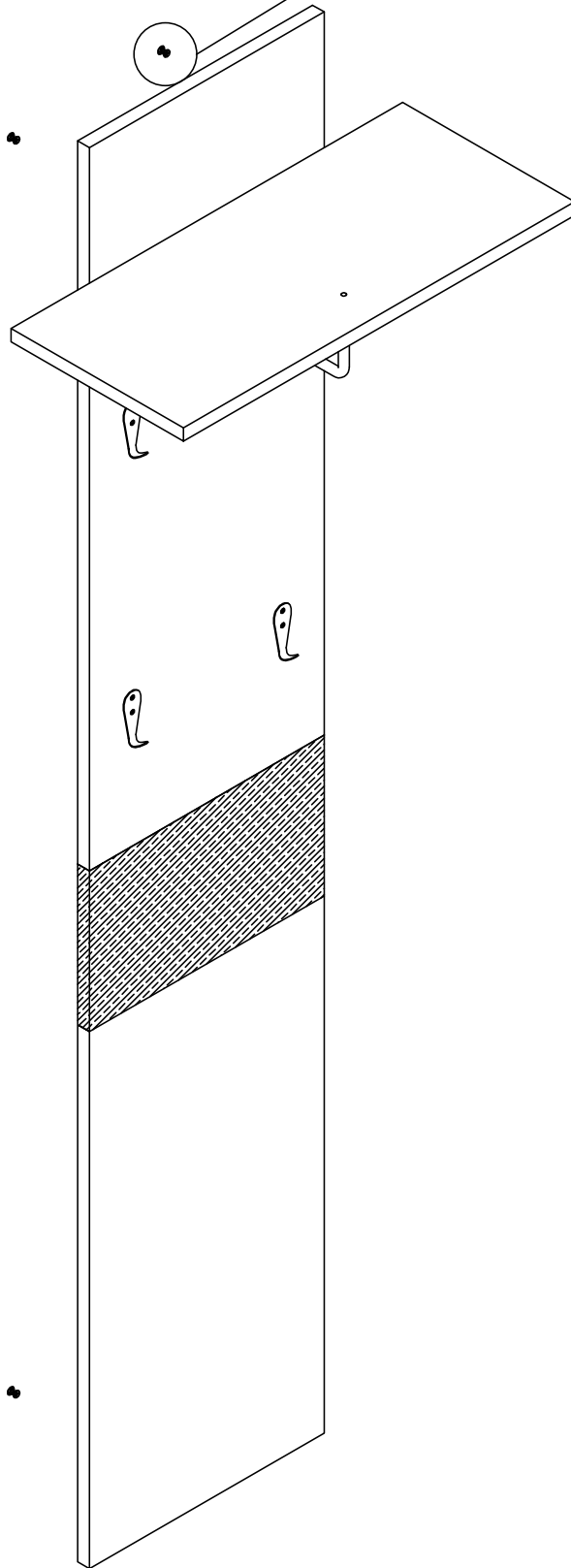
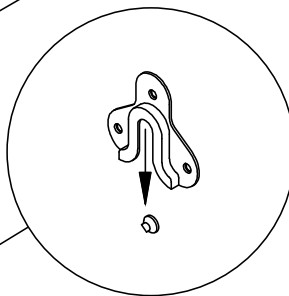

**PT** Se for uma parede sólida, use por favor parafusos de expansão e auto-roscantes, se for uma parede de madeira, use apenas parafusos auto-roscantes, por favor não aperte demasiado os parafusos.

**DE** Wenn es sich um eine Massivwand handelt, verwenden Sie bitte Dehnungs- und selbstschneidende Schrauben. Wenn es sich um eine Holzwand handelt, verwenden Sie nur selbstschneidende Schrauben, bitte ziehen Sie die Schrauben nicht zu fest an.



**IT** Se si tratta di un muro solido, utilizzare sia viti ad espansione che autofilettanti. Se si tratta di una parete in legno, utilizzare solo viti autofilettanti, non stringere eccessivamente le viti.





If you have any questions, please contact our customer care center. **US**  
Our contact details are below:  
 001-877-644-9366  
 customerservice@aosom.com  
Imported by Aosom LLC  
27150 SW Kinsman Rd Wilsonville, OR 97070 USA  
MADE IN CHINA

Si tiene alguna pregunta, comuníquese con nuestro Centro de Atención al Cliente. **ES**  
Nuestros datos de contacto son los siguientes:  
 0034-931294512  
 atencioncliente@aosom.es  
IMPORTADOR:  
SPANISH AOSOM, S.L.  
C/ ROC GROS, Nº 15. 08550, ELS HOSTALETES DE BALENYÀ, SPAIN.  
B66295775  
WWW.AOSOM.ES  
HECHO EN CHINA



If you have any questions, please contact our customer care center. **CA**  
Our contact details are below:  
 416-792-6088  
 customerservice@aosom.ca  
Imported by Aosom Canada Inc.  
7270 Woodbine Avenue, Unit 307, Markham, Ontario Canada L3R 4B9  
MADE IN CHINA

Se tiver alguma dúvida, por favor contacte o nosso Centro de Atendimento ao Cliente. **PT**  
Os nossos dados de contacto são os seguintes:  
 0034-931294512 (SEG-SEX DAS 7:30H ÀS 16:30H)  
 info@aosom.pt.  
IMPORTADOR:  
SPANISH AOSOM, S.L  
C.ROC GROS N.15, 08550. ELS HOSTALETES DE BALENYÀ  
WWW.AOSOM.PT

Si vous avez la moindre question, veuillez contacter notre centre d'assistance à la clientèle. **FR**  
Nos coordonnées sont les suivantes:  
 416-792-6088  
 customerservice@aosom.ca  
Importé par Aosom Canada Inc.  
7270 Woodbine Avenue, unité 307, Markham, Ontario Canada L3R 4B9  
Fabriqué en Chine

Wenn Sie Fragen haben, wenden Sie sich bitte an unser Kundendienstzentrum. **DE**  
Unsere Kontaktdaten stehen unten:  
 0049-0(40)-88307530  service@aosom.de  
ADRESSE DES IMPORTEUR:  
MH Handel GmbH  
Wendenstraße 309  
D-20537 Hamburg  
Germany  
IN CHINA HERGESTELLT

If you have any questions, please contact our customer care center. **UK**  
Our contact details are below:  
 0044-800-240-4004  
 enquiries@mhstar.co.uk  
IMPORTER ADDRESS:  
MH STAR UK LTD  
Unit 27, Perivale Park,  
Horsenden lane South  
Perivale, UB6 7RH  
MADE IN CHINA

In caso di dubbio, si prega di contattare il nostro centro assistenza clienti. **IT**  
I nostri dettagli di contatto sono di seguito:  
 0039-0249471447  clienti@aosom.it  
IMPORTATO DA:  
AOSOM Italy srl  
Centro Direzionale Milanofiori  
Strada 1 Palazzo F1  
20057 Assago (MI)  
P.I.: 08567220960  
FATTO IN CINA

Si vous avez la moindre question, veuillez contacter notre centre d'assistance à la clientèle. **FR**  
Nos coordonnées sont les suivantes:  0033-1-84166106  aosom@mhfrance.fr  
Importé par: MH France 2, rue Maurice Hartmann 92130 Issy-les-Moulineaux  
Fabriqué en Chine  
France



Adresses sur quefairedemesdechets.fr