

**EN\_IMPORTANT, RETAIN FOR FUTURE REFERENCE: READ CAREFULLY.**

**FR\_IMPORTANT: A LIRE ATTENTIVEMENT ET À CONSERVER POUR CONSULTATION ULTÉRIEURE.**

**ES\_IMPORTANTE, LEA Y GUARDE PARA FUTURAS REFERENCIAS.**

**PT\_IMPORTANTE, RETER PARA REFERÊNCIA FUTURA: LEIA ATENTAMENTE.**

**DE\_WICHTIG! SORGFÄLTIG LESEN UND FÜR SPÄTER NACHSCHLAGEN AUFBEWAHREN.**

**IT\_IMPORTANTE! CONSERVARE IL PRESENTE MANUALE PER FUTURO RIFERIMENTO E LEGGERLO ATTENTAMENTE.**

# **IMPORTANT, RETAIN FOR FUTURE REFERENCE: READ CAREFULLY.**

## **Only for domestic use**

### **Instructions for use:**

- \*Put the chair stably on a flat floor.
- \*Stay away from open flames.
- \*Avoid the overload at the chair.

### **Precautions before assembly:**

- \*Prepare a clean and dry mounting area.
- \*Verify that the product is not damaged.
- \*Check that none of the pieces are missing.

### **Maintenance:**

- \*Clean with a soft fabric.
- \*Check the seating regularly.

### **Storage conditions:**

- \*The fabric should be stored completely dry, in a clean and dry place to avoid the risks of mold.

## **Beware of crushing and cutting hazards during assembly.**

**The manufacturer declines all responsibility in case of damages due to a bad installation or withering.**

**If the seating is fitted with powered seat height adjustments, only trained personnel may replace or repair those components.**

# **IMPORTANT: A LIRE ATTENTIVEMENT ET À CONSERVER POUR CONSULTATION ULTÉRIEURE.**

## **Réservé à un usage domestique**

### **Conseils :**

- \*Placez la chaise sur un sol plat et sec afin qu'elle soit stable
- \*Placer à l'écart des flammes ou de sources de chaleur
- \*Ne pas dépasser la charge maximale autorisée

### **Précautions avant l'assemblage :**

- \*Préparez une zone de montage propre et sèche
- \*Vérifiez que le produit n'est pas endommagé
- \*Vérifiez qu'aucune des pièces de ne manque

### **Recommandations d'entretien :**

- \*Veuillez utiliser un chiffon doux pour essuyer la chaise
- \*Vérifiez régulièrement la structure du produit

### **Conditions de stockage:**

- \*Veuillez stocker le produit dans un environnement propre et sec pour éviter tout risque de moisissure.

**Veillez faire attention à ne pas vous blesser lors de l'assemblage du produit.**

**Le fabricant n'est pas responsable des dommages causés par une mauvaise installation.**

**Si le fauteuil est équipé d'un dispositif de hauteur réglable avec moteur, seule une personne qualifiée peut remplacer ou réparer la partie motorisée.**

# IMPORTANTE, LEA Y GUARDE PARA FUTURAS REFERENCIAS.

## Producto para uso doméstico

### Consejos de uso:

- \* Coloque el producto sobre un suelo plano de forma estable.
- \* Manténgase alejado de fuentes de calor y llamas.
- \* Evite la sobrecarga de los anclajes del producto.

### Precauciones antes del montaje:

- \* Prepare la zona de montaje. Asegúrese de que esté limpia y seca.
- \* Asegúrese de que el producto está en buen estado.
- \* Verifique que no falta ninguna de las piezas.

### Mantenimiento:

- \* Limpie el producto con la ayuda de un paño suave.
- \* Inspeccione el producto de forma regular a fin de detectar posibles daños o desperfectos que puedan afectar a su uso.

### Condiciones de almacenaje:

- \* A fin de evitar la aparición de moho, los tejidos se deben de guardar totalmente secos y en un lugar limpio y sin humedad.

### Atención:

**Riesgo de pinzamientos o cortes durante el montaje.**

**El fabricante declina toda responsabilidad en caso de deterioro debido a una mala instalación o por causas meteorológicas.**

**Si el producto está equipado con algún mecanismo eléctrico de ajuste de altura o similar, solo podrá ser reemplazado o reparado por personal capacitado y técnicos.**

# **IMPORTANTE, RETER PARA REFERÊNCIA FUTURA: LEIA ATENTAMENTE.**

## **Produto para uso doméstico**

### **Conselhos de uso:**

- \* Coloque o produto sobre um solo plano e estável.
- \* Mantenha-o afastado de fontes de calor e chamas.
- \* Evite a sobre carga das fixações do produto.

### **Precauções antes da montagem:**

- \* Prepare a zona de montagem. Certifique-se de que esteja limpa e seca.
- \* Certifique-se que o produto esteja em bom estado.
- \* Verifique que não falte nenhuma das peças.

### **Manutenção:**

- \* Limpar o produto com a ajuda de um pano suave.
- \* Inspeccionar o produto de forma regular a fim de detectar possíveis defeitos que possa afetar seu uso.

### **Condições de armazenamento:**

- \*A fim de evitar a aparecimento de mofo, os tecidos se devem guardar totalmente secos e em um lugar limpo e sem umidade.

### **Atenção:**

**Risco de cortes durante a montagem. O fabricante declina toda responsabilidade no caso de deterioração devido uma má instalação ou por causas meteorológicas.**

**Se o produto estiver equipado com algum mecanismo elétrico de ajuste de altura ou similar, somente poderá ser substituído ou reparado por uma pessoa qualificada ou técnicos.**

# **WICHTIG! SORGFÄLTIG LESEN UND ZUM SPÄTEREN NACHSCHLAGEN AUFBEWAHREN.**

## **Ausschließlich für den häuslichen Gebrauch bestimmt Nutzungshinweise:**

- \*Bitte stellen Sie den Stuhl stabil auf eine ebene Fläche.
- \*Von offenen Feuerquellen fernhalten.
- \*Vermeiden Sie eine Überlastung des Stuhls.

## **Vorsichtsmaßnahmen vor der Montage:**

- \*Bitte bereiten Sie einen sauberen und trockenen Montagebereich vor.
- \*Stellen Sie sicher, dass das Produkt nicht beschädigt ist.
- \*Vergewissern Sie sich, dass kein Zubehörteil fehlt.

## **Instandhaltung:**

- \*Bitte reinigen Sie den Stuhl nur mit einem weichen Tuch.
- \*Überprüfen Sie den Stuhl regelmäßig.

## **Lagerung:**

- \*Der Stoff sollte an einem völlig trockenen und sauberen Ort aufbewahrt werden, um Schimmel zu vermeiden.

## **Vorsicht vor Quetsch- und Schnittgefahr bei der Montage.**

**Der Hersteller lehnt jegliche Haftung für Schäden ab, die aufgrund unsachgemäßer Montage oder Witterungseinflüsse verursacht werden. Falls der Stuhl mit einer elektronischen Höhenverstellung geliefert wird, dürfen Reparaturarbeiten nur von qualifiziertem Personal durchgeführt werden.**

# **IMPORTANTE! CONSERVARE IL PRESENTE MANUALE PER FUTURO RIFERIMENTO E LEggerLO ATTENTAMENTE.**

## **Solo per uso domestico**

### **Istruzioni per l'uso:**

\*Posizionare la sedia in maniera stabile su un pavimento in piano.

\*Tenere lontano dalle fiamme vive.

\*Evitare di sovraccaricare la sedia.

### **Precauzioni prima del montaggio:**

\*Preparare un'area di montaggio sgombra e asciutta.

\*Verificare che il prodotto non sia danneggiato.

\*Verificare che non manchi nessun pezzo.

### **Manutenzione:**

\*Pulire con un tessuto morbido.

\*Controllare regolarmente il sedile.

### **Condizioni di stoccaggio:**

\*Il tessuto deve essere conservato completamente asciutto, in un luogo pulito e asciutto per evitare la formazione di muffa.

**Fare attenzione al rischio di schiacciamento e di taglio durante le fasi di montaggio.**

**Il produttore declina ogni responsabilità in caso di danni dovuti ad un'installazione incorretta o alle intemperie.**

**Se la sedia è dotata di un'unità di regolazione elettrica dell'altezza del sedile, solo il personale qualificato può sostituire o riparare questi componenti elettrici.**

## PARTS

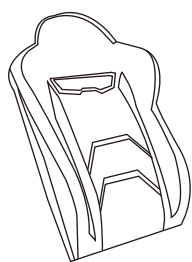

A x 1

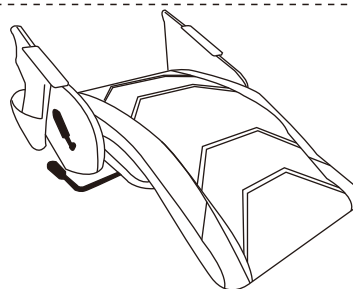

B x 1

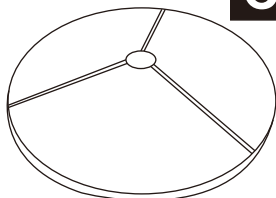

C x 1

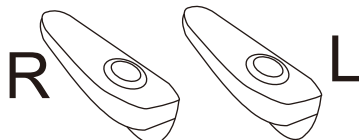

D x 1

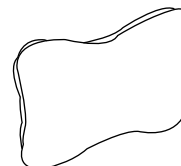

E x 1



F x 1

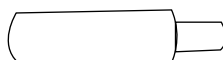

G x 1



H x 2

## HARDWARE



I x 1

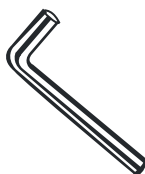

J x 1

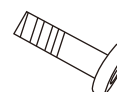
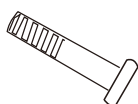
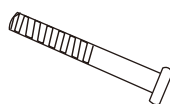
a x 4  
M6\*15b x 4  
M6\*20c x 2  
M8\*55

d x 1

**EN**\_Do not confuse similar screws.Do not tighten bolts fully until all parts are connected!

**FR**\_Ne pas confondre des vis similaires.Ne serrez pas les boulons à fond tant que toutes les pièces ne sont pas connectées!

**ES**\_No confunda tornillos similares.No apriete los tornillos completamente hasta que todas las partes están conectadas!

**PT**\_Não confundir parafusos semelhantes. Não apertar completamente os parafusos até que todas as peças estejam encaixadas!

**DE**\_Verwechseln Sie ähnliche Schrauben nicht.Ziehen Sie die Schrauben erst fest an, wenn alle Teile verbunden sind!

**IT**\_Non confondere le viti simili.non serrare completamente i bulloni fino a tutte le parti non sono ancora collegate!

## NOTE



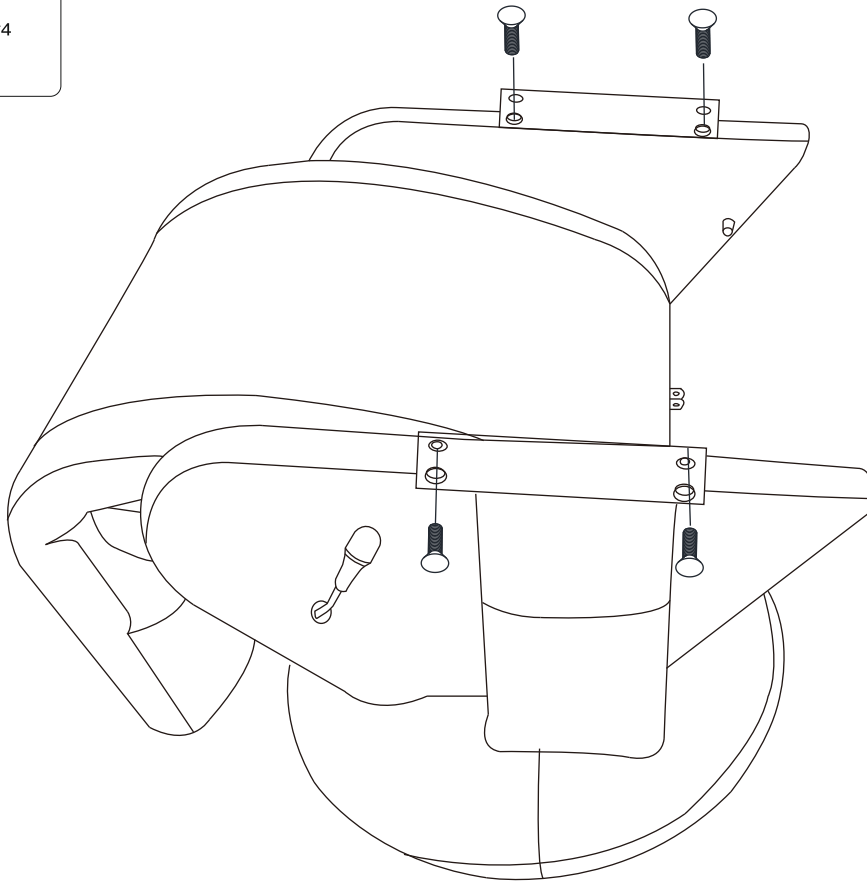
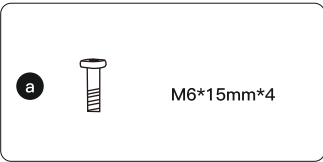
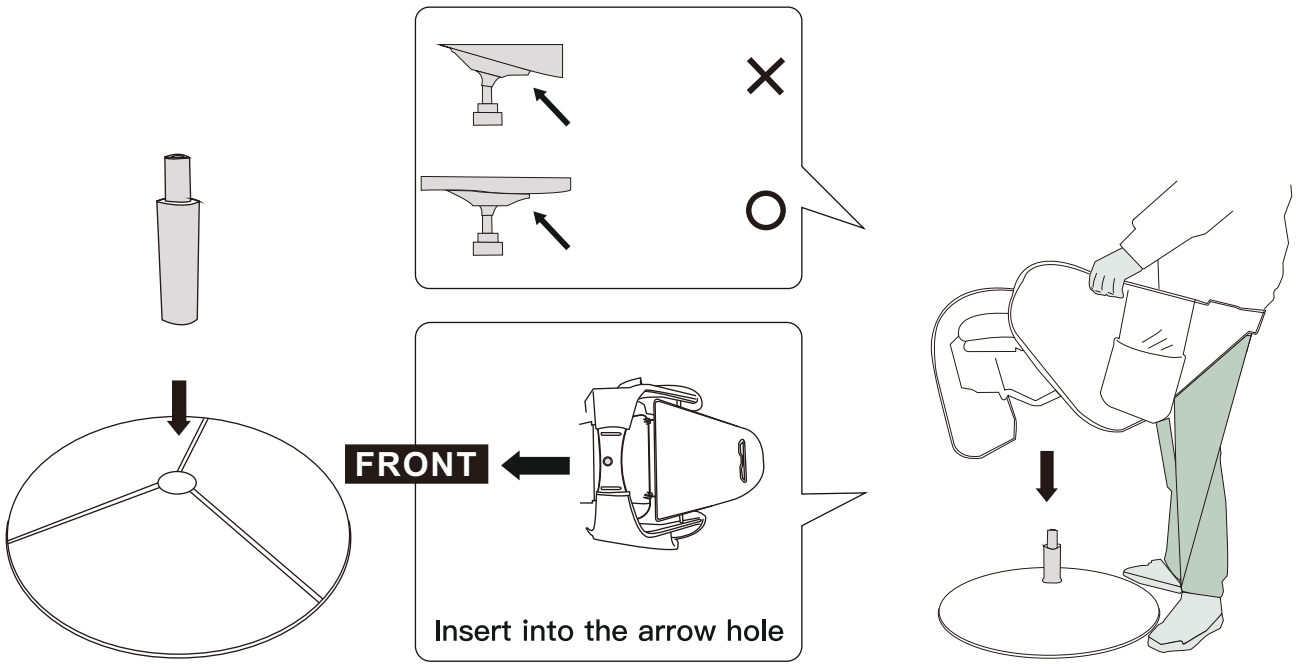

b M6\*20mm \*4

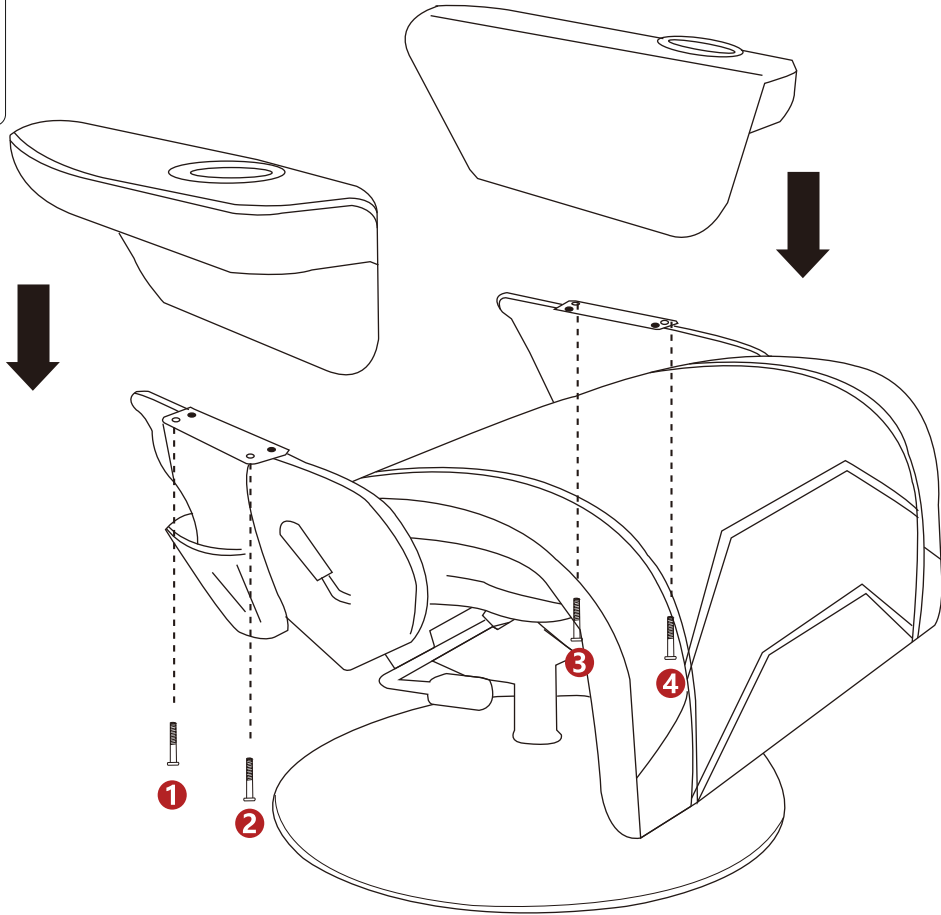

d

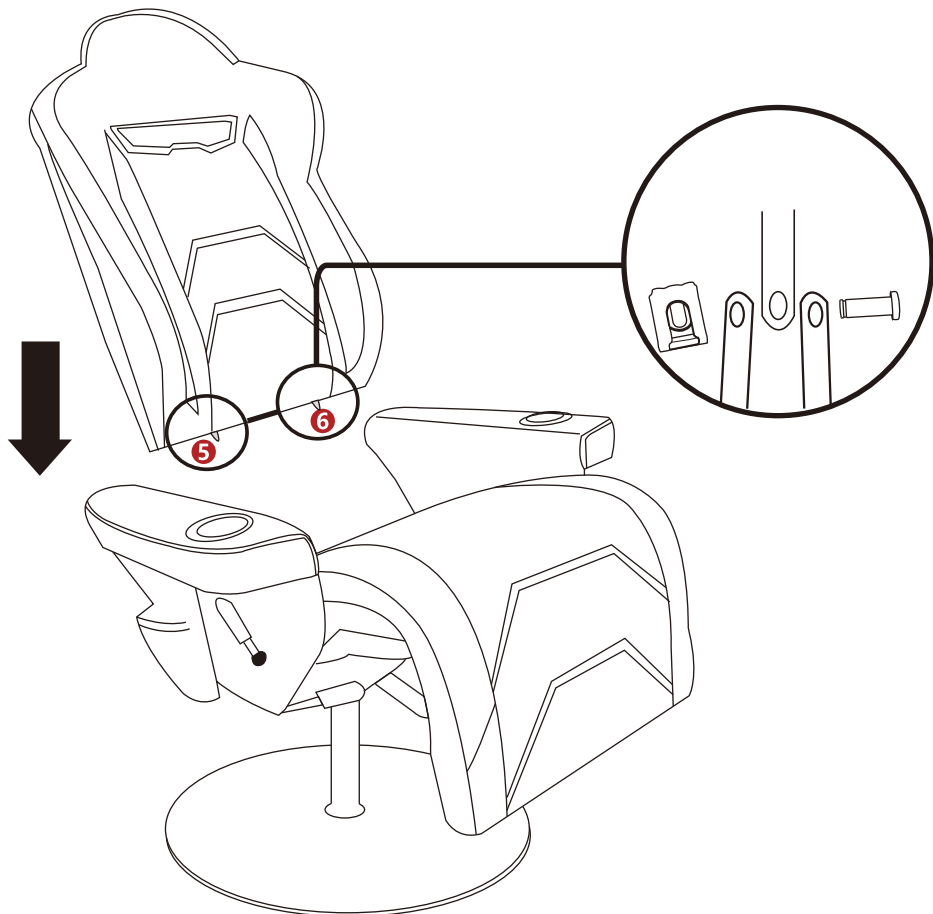
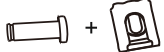

C



M8\*55mm \*2

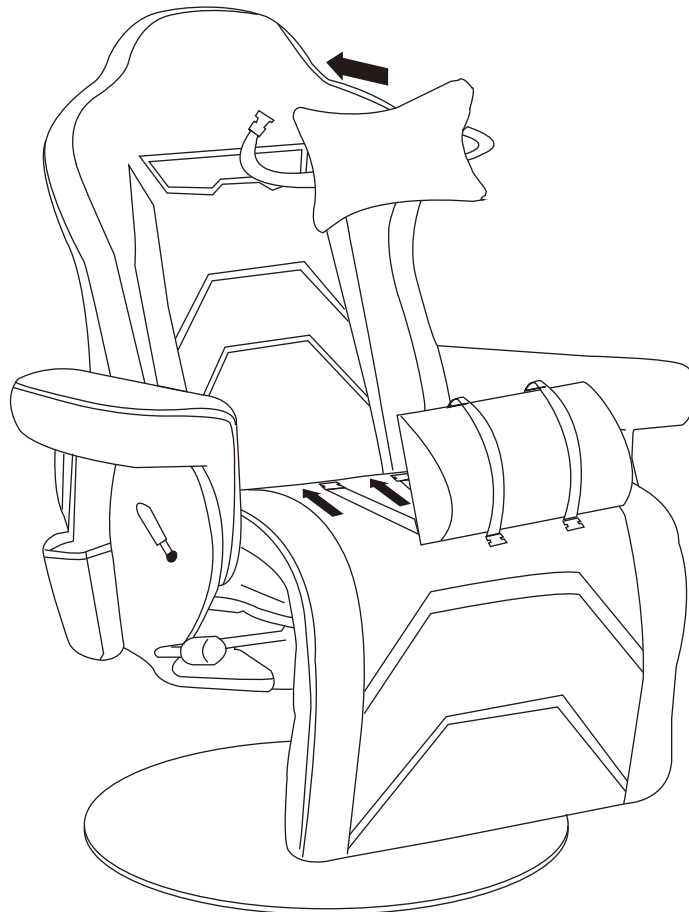
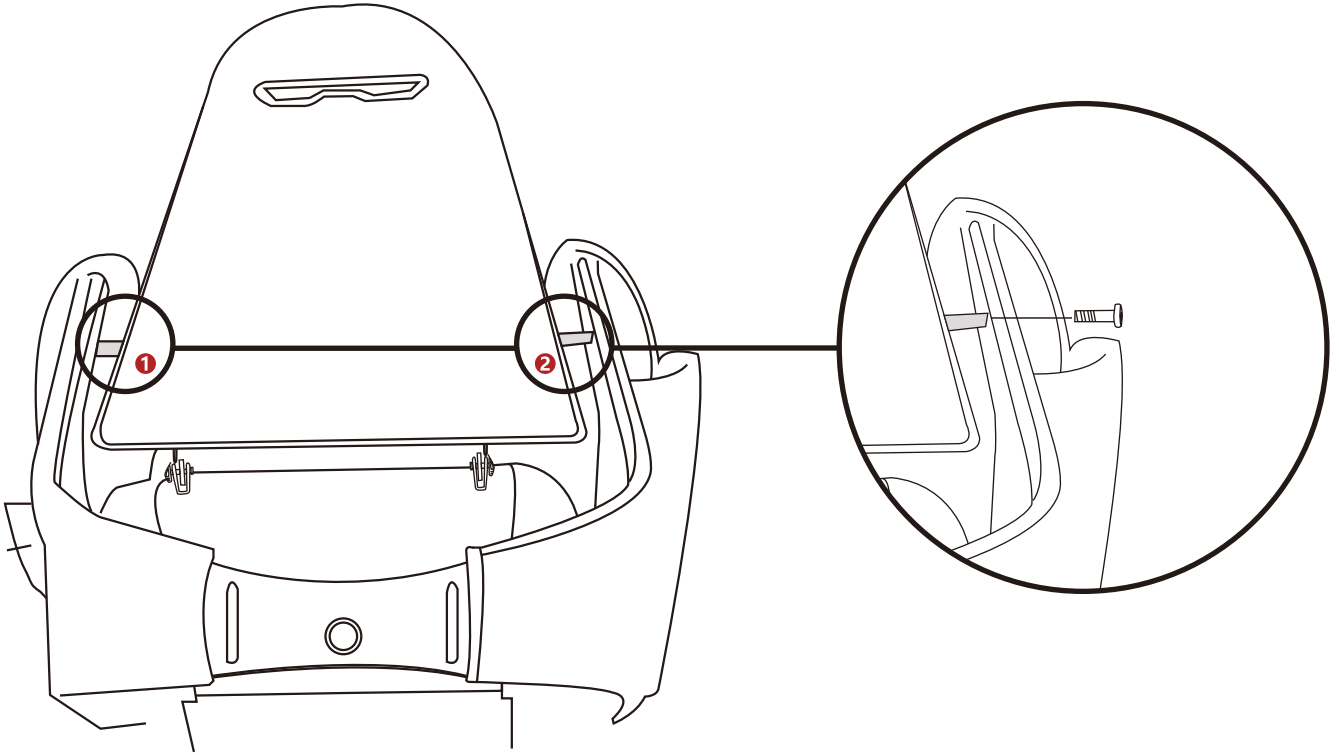

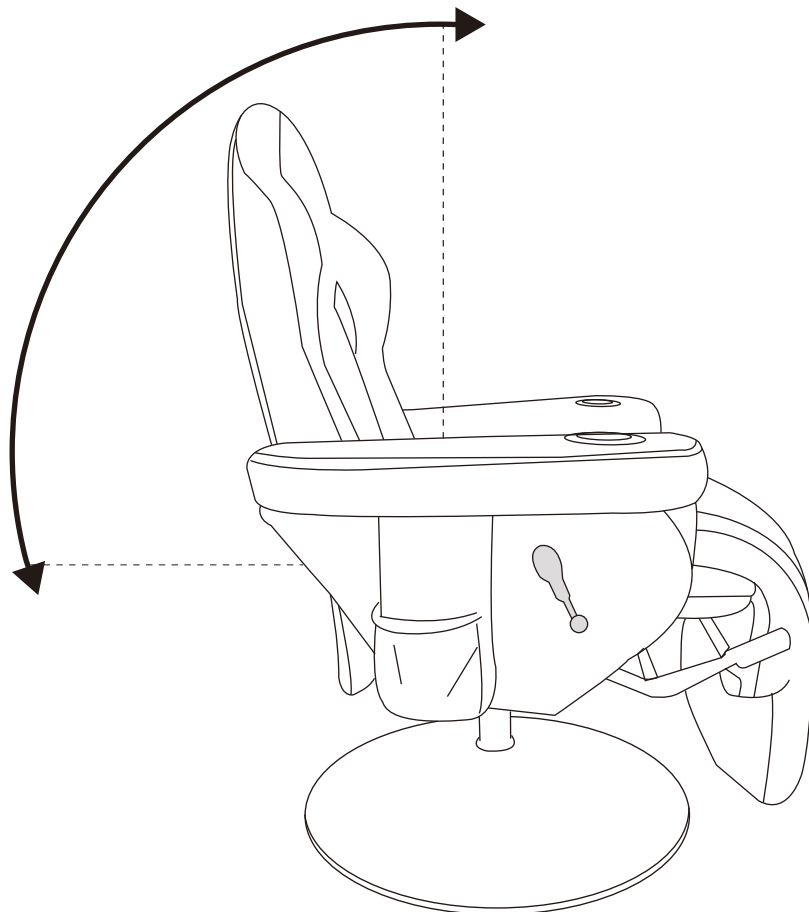
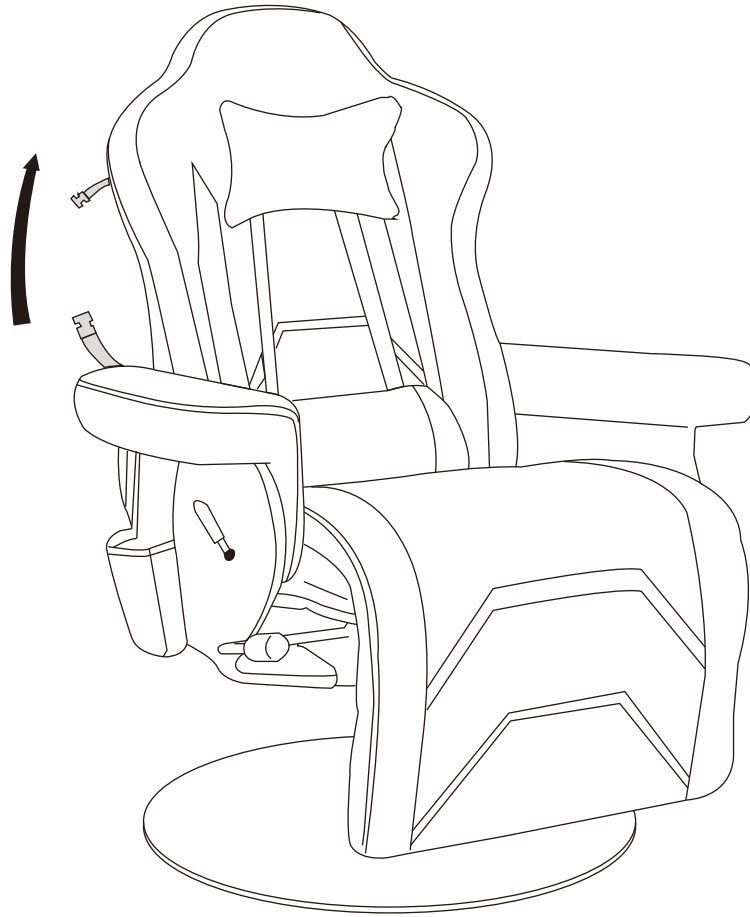

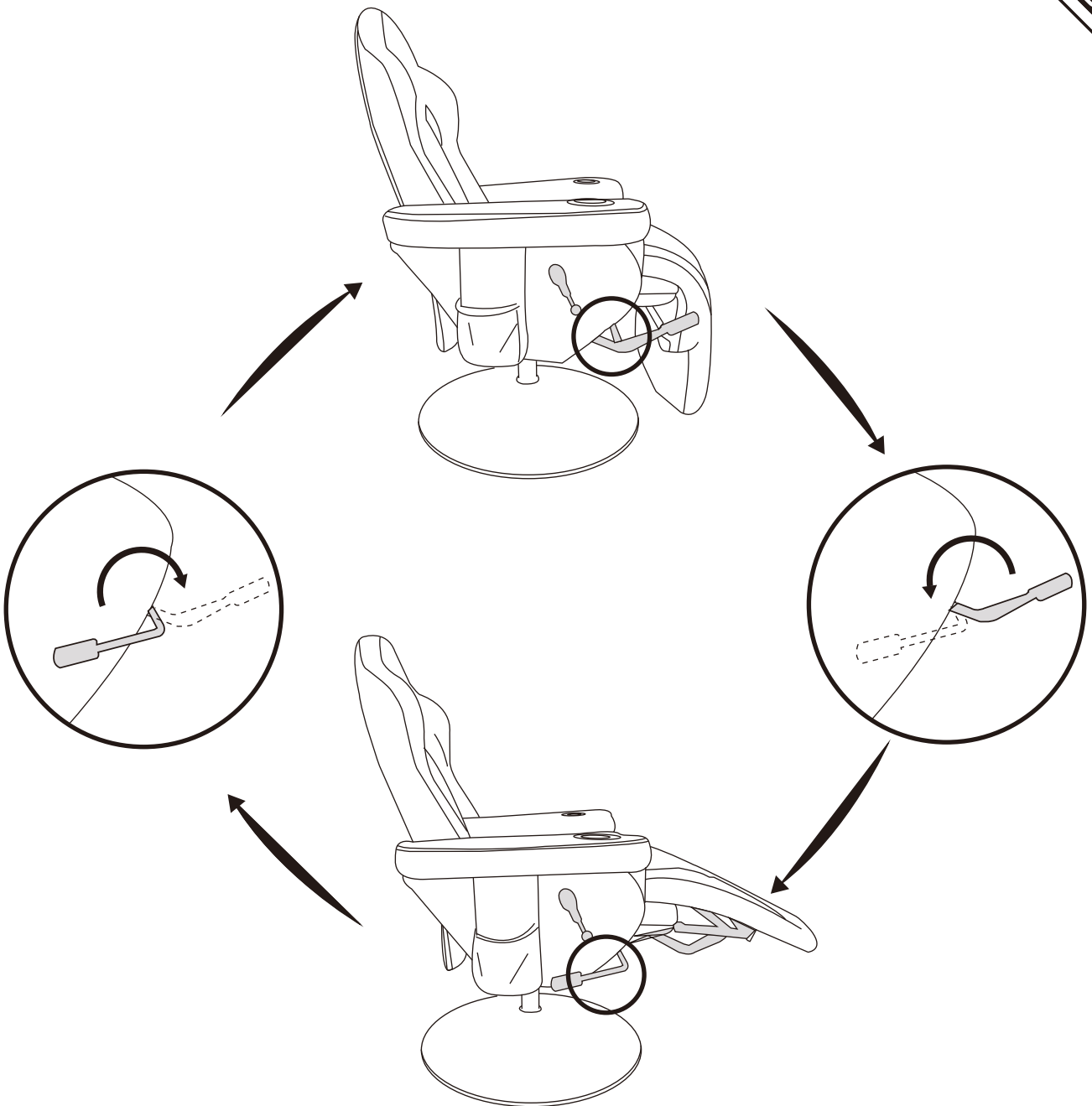
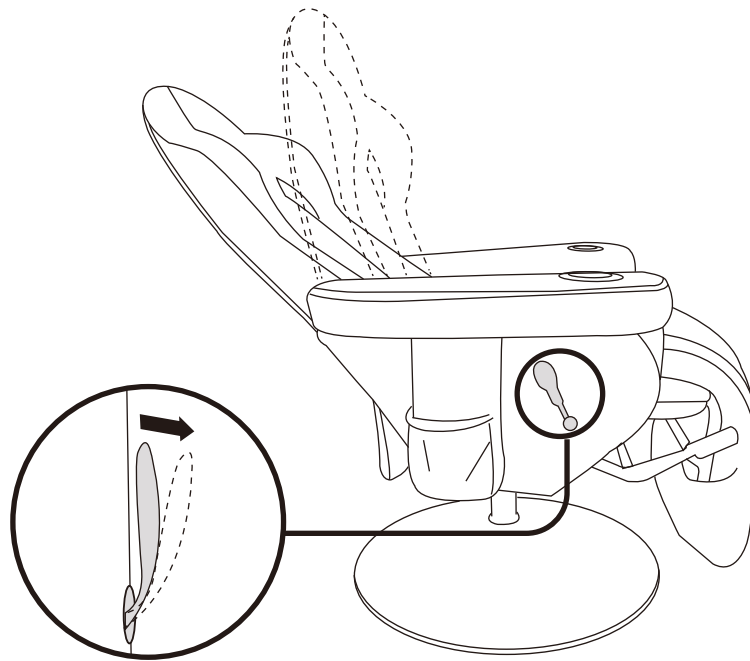

If you have any questions, please contact our customer care center.

Our contact details are below:

 001-877-644-9366

 customerservice@aosom.com

Imported by Aosom LLC

27150 SW Kinsman Rd Wilsonville, OR 97070 USA

MADE IN CHINA

**US**

Si tiene alguna pregunta, comuníquese con nuestro Centro de Atención al Cliente.

Nuestros datos de contacto son los siguientes:

 0034-931294512

 atencioncliente@aosom.es

IMPORTADOR:

SPANISH AOSOM, S.L.

C/ ROC GROS, Nº 15. 08550, ELS HOSTALETES DE BALENYÀ, SPAIN.

B66295775

WWW.AOSOM.ES

HECHO EN CHINA

**ES**

If you have any questions, please contact our customer care center.

Our contact details are below:

 416-792-6088

 customerservice@aosom.ca

Imported by Aosom Canada Inc.

7270 Woodbine Avenue, Unit 307, Markham,

Ontario Canada L3R 4B9

MADE IN CHINA

**CA**

Se tiver alguma dúvida, por favor contacte o nosso Centro de Atendimento ao Cliente.

Os nossos dados de contacto são os seguintes:

 0034-931294512 (SEG-SEX DAS 7:30H ÀS 16:30H)

 info@aosom.pt.

IMPORTADOR:

SPANISH AOSOM, S.L

C.ROC GROS N.15, 08550. ELS HOSTALETES DE BALENYÀ

WWW.AOSOM.PT

**PT**

Si vous avez la moindre question, veuillez contacter notre centre d'assistance à la clientèle.

Nos coordonnées sont les suivantes:

 416-792-6088

 customerservice@aosom.ca

Importé par Aosom Canada Inc.

7270 Woodbine Avenue, unité 307,

Markham, Ontario Canada L3R 4B9

Fabriqué en Chine

**DE**

Wenn Sie Fragen haben, wenden Sie sich bitte an unser Kundendienstzentrum.

Unsere Kontaktdaten stehen unten:

 0049-0(40)-88307530  service@aosom.de

ADRESSE DES IMPORTEURE:

MH Handel GmbH

Wendenstraße 309

D-20537 Hamburg

Germany

IN CHINA HERGESTELLT

**IT**

In caso di dubbio, si prega di contattare il nostro centro assistenza clienti.

I nostri dettagli di contatto sono di seguito:

 0039-0249471447  clienti@aosom.it

IMPORTATO DA:

AOSOM Italy srl

Centro Direzionale Milanofiori

Strada 1 Palazzo F1

20057 Assago (MI)

P.I.: 08567220960

FATTO IN CINA

**UK**

If you have any questions, please contact our customer care center.

Our contact details are below:

 0044-800-240-4004

 enquiries@mhstar.co.uk

IMPORTER ADDRESS:

MH STAR UK LTD

Unit 27, Perivale Park,

Horsenden lane South

Perivale, UB6 7RH

MADE IN CHINA

**FR**

Si vous avez la moindre question, veuillez contacter notre centre d'assistance à la clientèle.

Nos coordonnées sont les suivantes:  0033-1-84166106  aosom@mhfrance.fr

Importé par: MH France 2, rue Maurice Hartmann 92130 Issy-les-Moulineaux

Fabriqué en Chine

France



FR

**DONNEZ  
OU  
RECYCLEZ**



OU



OU



ASSOCIATION LIVRAISON DÉCHÈTERIE

Adresses sur [quefairedemesdechets.fr](http://quefairedemesdechets.fr)