

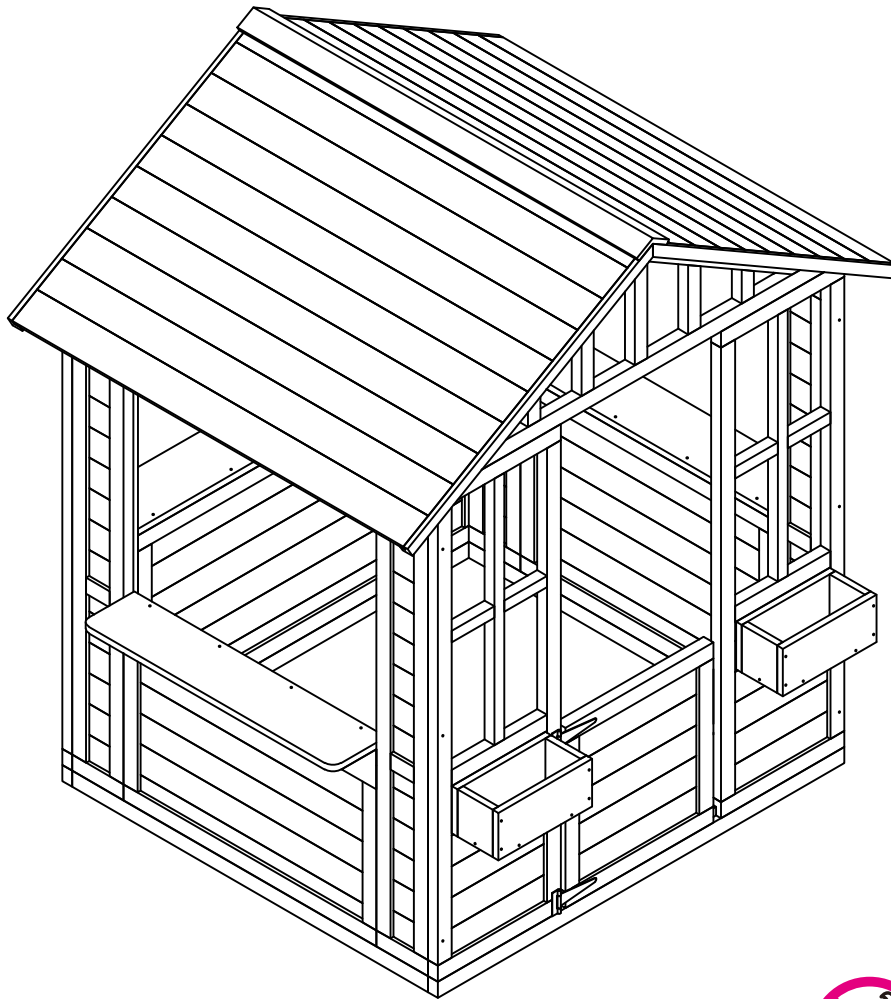

IN230400007V02\_GL

345-021\_345-021V00



EN: Suitable for children of 3-8 years old.

FR: Convient aux enfants de 3 à 8 ans.

DE: Geeignet für Kinder im Alter von 3-8 Jahren.

ES: Adecuado para los niños de 3 a 8 años.

IT: Adatto a bambini di 3-8 anni;

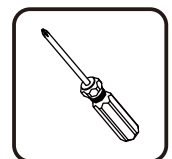
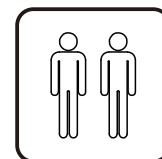

**EN\_IMPORTANT, RETAIN FOR FUTURE REFERENCE: READ CAREFULLY.**

**FR\_IMPORTANT: A LIRE ATTENTIVEMENT ET À CONSERVER POUR CONSULTATION ULTÉRIURE.**

**ES\_IMPORTANTE, LEA Y GUARDE PARA FUTURAS REFERENCIAS.**

**DE\_WICHTIG! SORGFÄLTIG LESEN UND FÜR SPÄTER NACHSCHLAGEN AUFBEWAHREN.**

**IT\_IMPORTANTE! CONSERVARE IL PRESENTE MANUALE PER FUTURO RIFERIMENTO E LEGGERLO ATTENTAMENTE.**

EN

**WARNING:**

1. CHOKING HAZARD—Small parts. Not for children under 3 years.
2. Only allowed for adults to install, keep children away.
3. To be used under the direct supervision of an adult.
4. Place it on a flat and clean floor, Check all the parts are well connected before use.

**MAINTENANCE & CARE**

- A. Keep all instructions and parts relating to this product for future reference.
- B. Please wipe down with a dry or damp cloth.

FR

**AVERTISSEMENT :**

1. RISQUE D'ÉTOUFFEMENT - Petites pièces. Déconseillé aux enfants de moins de 3 ans.
2. Installation par des adultes uniquement, tenir les enfants à l'écart.
3. À utiliser sous la surveillance directe d'un adulte.
4. Posez-le sur un sol plat et propre. Vérifiez que toutes les pièces sont bien connectées avant toute utilisation.

**ENTRETIEN ET MAINTENANCE**

- A. Conservez toutes les instructions et les pièces relatives à ce produit pour pouvoir vous y référer ultérieurement.
- B. Veuillez essuyer avec un chiffon sec ou humide.



Adresses sur [quefairedemesdechets.fr](http://quefairedemesdechets.fr)

---

DE

---

**WARNUNG:**

1. ERSTICKUNGSGEFAHR-Kleine Teile. Nicht für Kinder unter 3 Jahren geeignet.
2. Die Montage darf nur von Erwachsenen vorgenommen werden, halten Sie Kinder fern.
3. Es ist unter der direkten Aufsicht eines Erwachsenen zu verwenden.
4. Stellen Sie es auf einen flachen und sauberen Boden. Prüfen Sie, ob alle Teile vor der Verwendung gut verbunden sind.

**WARTUNG & PFLEGE**

- A. Bewahren Sie alle Anweisungen und Teile, die sich auf dieses Produkt beziehen, zur späteren Verwendung auf.
- B. Bitte wischen Sie es mit einem trockenen oder feuchten Tuch ab.

---

ES

---

**ADVERTENCIA:**

1. PELIGRO DE ASFIXIA: Incluidas piezas pequeñas. No es adecuado para los niños menores de 3 años.
2. La instalación sólo se puede realizar por los adultos, mantenga a los niños alejados al instalar el producto.
3. El producto debe ser utilizado bajo la supervisión directa de un adulto.
4. Colóquelo sobre un piso plano y limpio. Verifique si todas las piezas estén conectadas adecuadamente antes de utilizarlo.

**MANTENIMIENTO Y CUIDADO**

- A. Guarde todas las instrucciones y piezas relativas juntas con este producto para las referencias futuras.
- B. Límpielo con un paño seco o humedecido.

---

IT











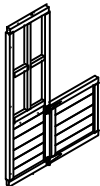

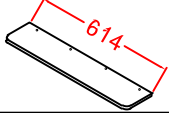
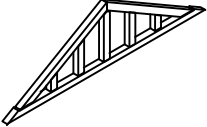
---

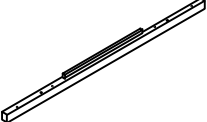
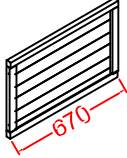
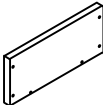



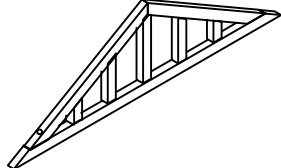
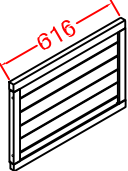

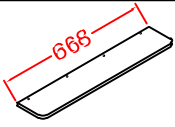
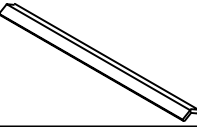
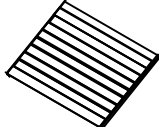
**AVVERTENZE:**

1. RISCHIO DI SOFFOCAMENTO — Parti piccole. Non adatte a bambini sotto i 3 anni.
2. Consentito solo agli adulti di installare, tenere lontani i bambini.
3. Da utilizzare sotto la diretta supervisione di un adulto.
4. Posizionarlo su una superficie piana e pulita, controllare che tutte le parti siano connesse correttamente prima dell'uso.

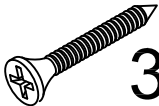
**MANUTENZIONE & CURA**

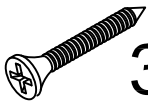
- A. Conservare tutte le istruzioni e le parti relative a questo prodotto per riferimenti futuri.
- B. Si prega di pulire passando un panno asciutto o inumidito.

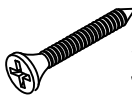
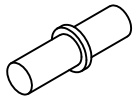
1		1PC	12		2PCS
2		1PC	13		2PCS
3		1PC	14		6PCS
4		1PC	15		1PC
5		4PCS	16		1PC
6		4PCS	17		1PC
7		2PCS	18		1PC
8		2PCS	19		1PC
9		4PCS	20		1PC
10		1PC	21		2PCS
11		2PCS			

A	 3.5*60	22PCS +1(spare)	E	 3.5*30	12PCS +1(spare)
B	 3.5*45	12PCS +1(spare)	F	 3*20	4PCS
C	 3.5*35	24PCS +1(spare)	G		12PCS +1(spare)
D	 3*35	28PCS +1(spare)			

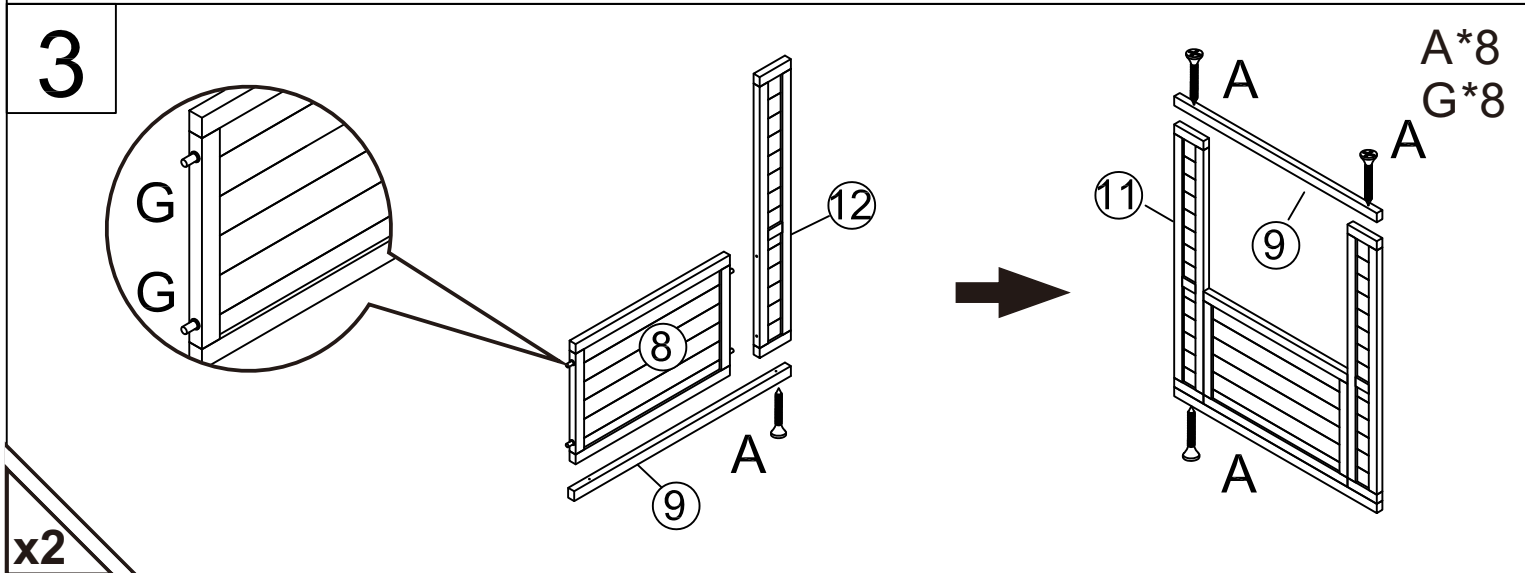
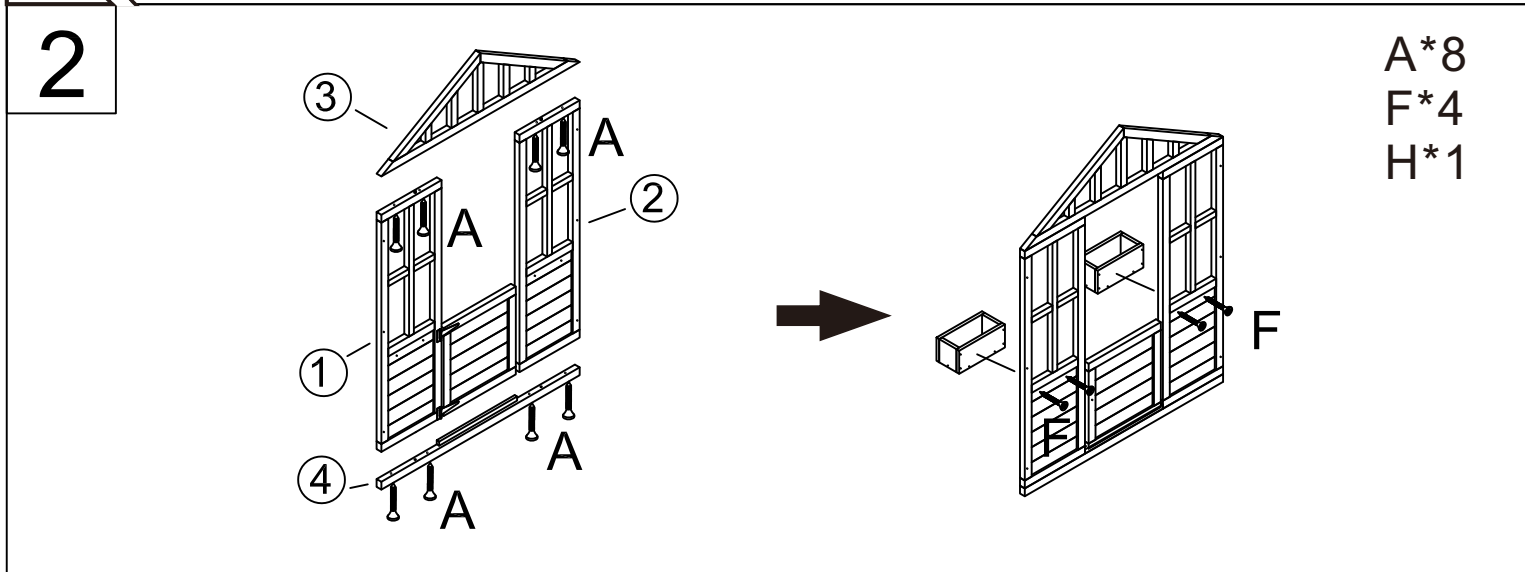
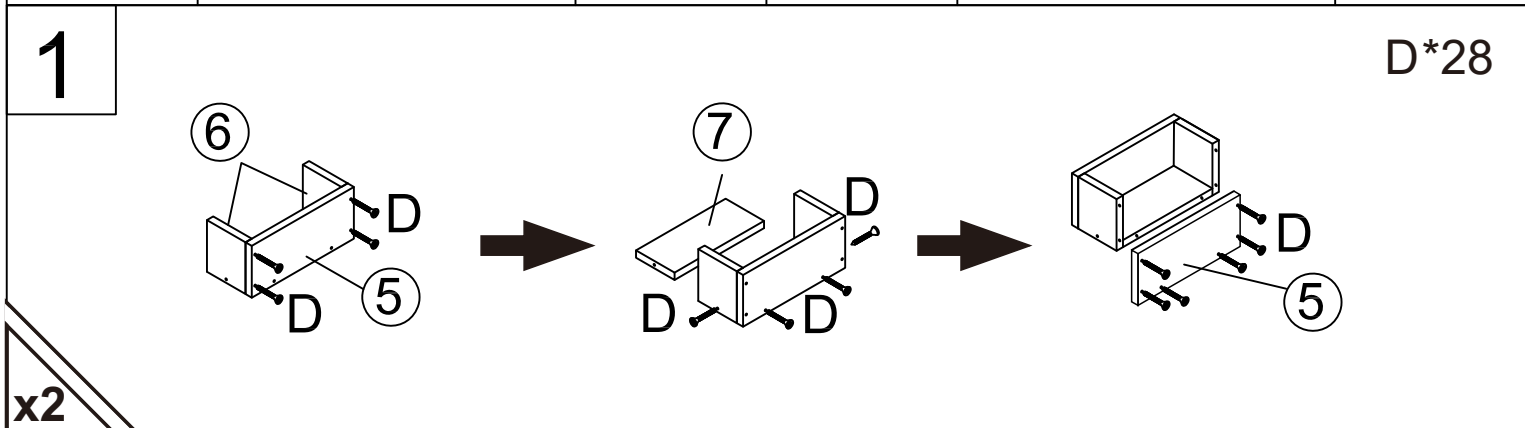

4

C\*16

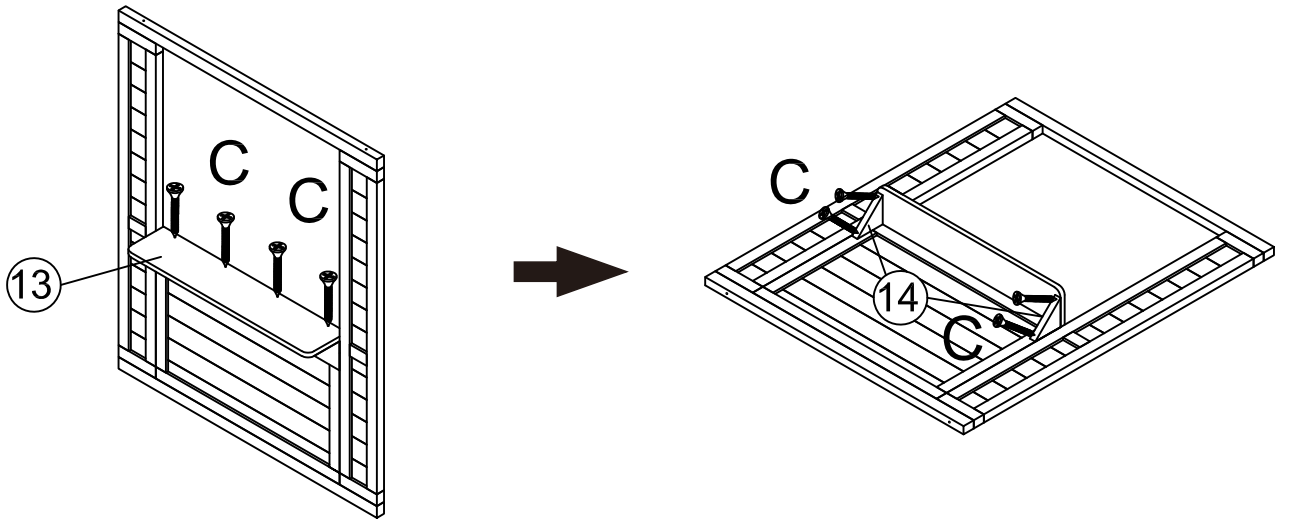

x2

5

A\*6  
G\*4

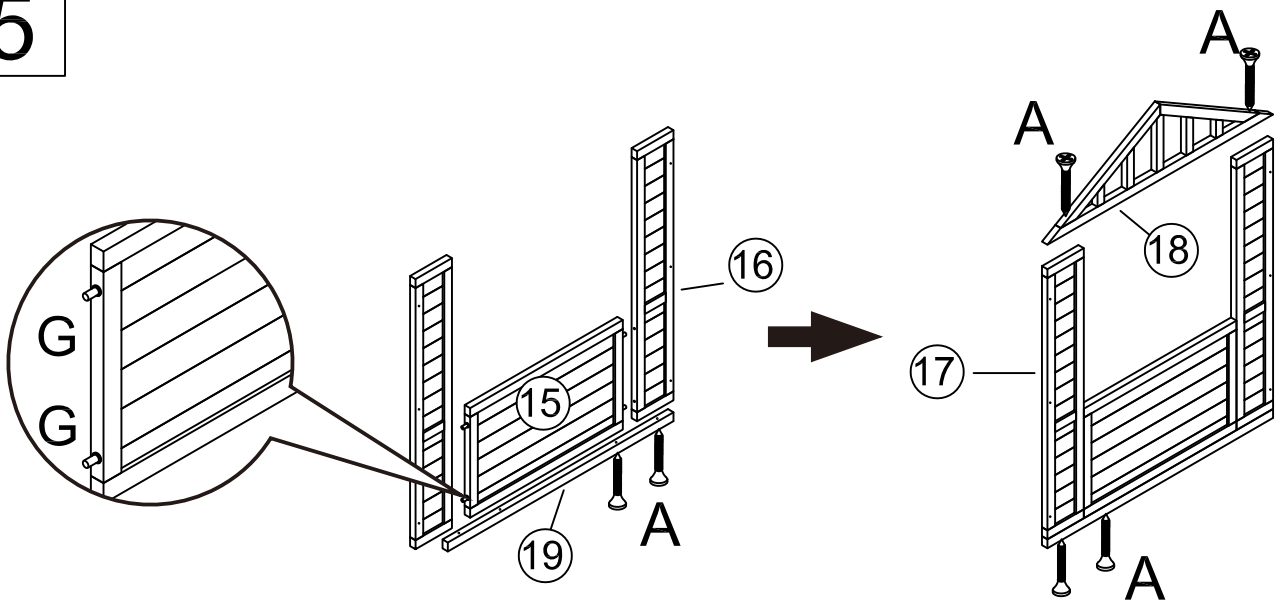

6

C\*8

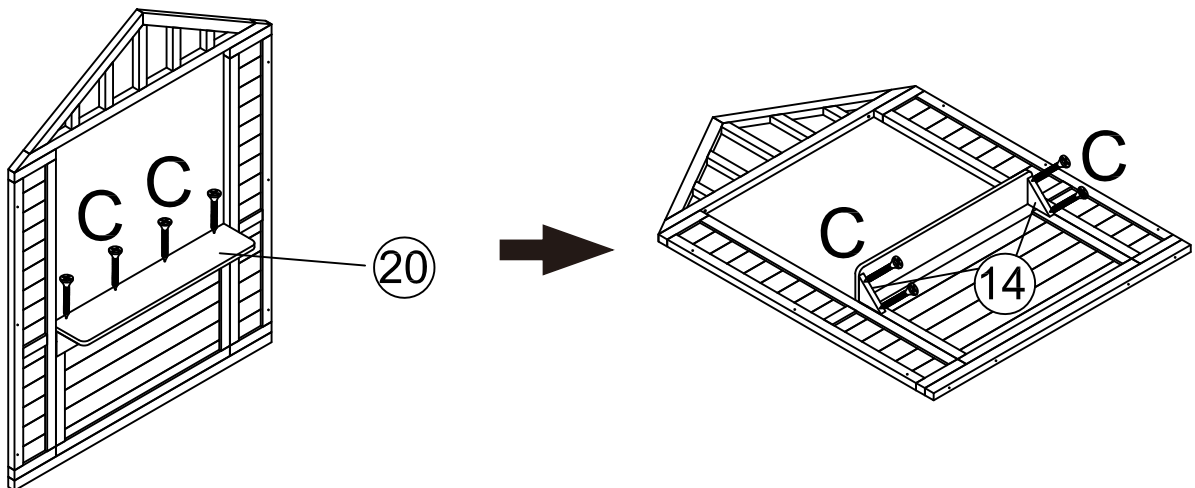

7

B\*6

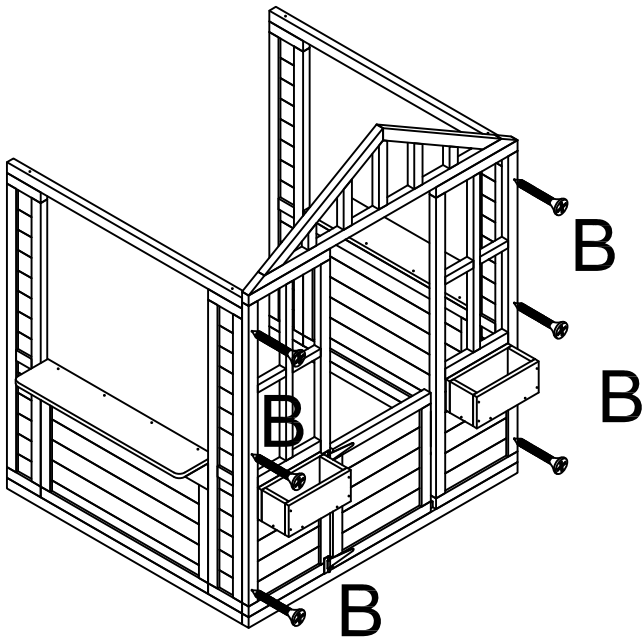

8

B\*6

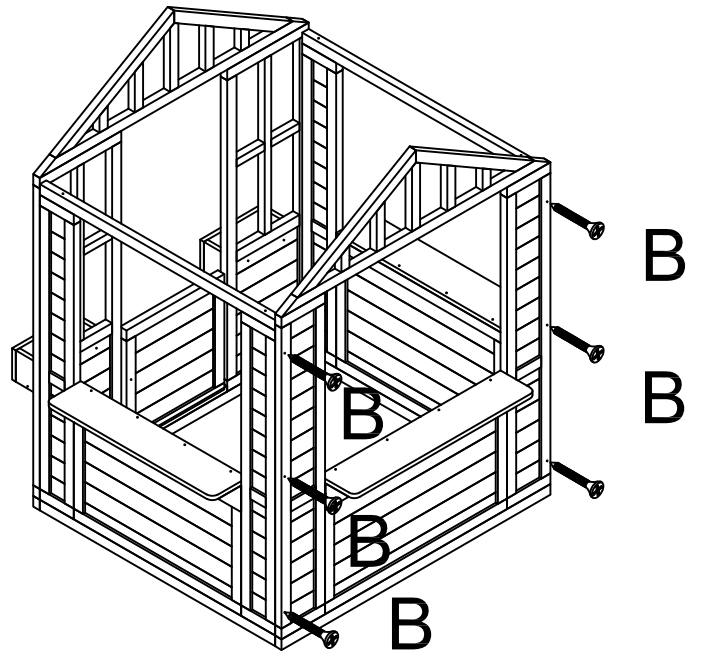

9

E\*8

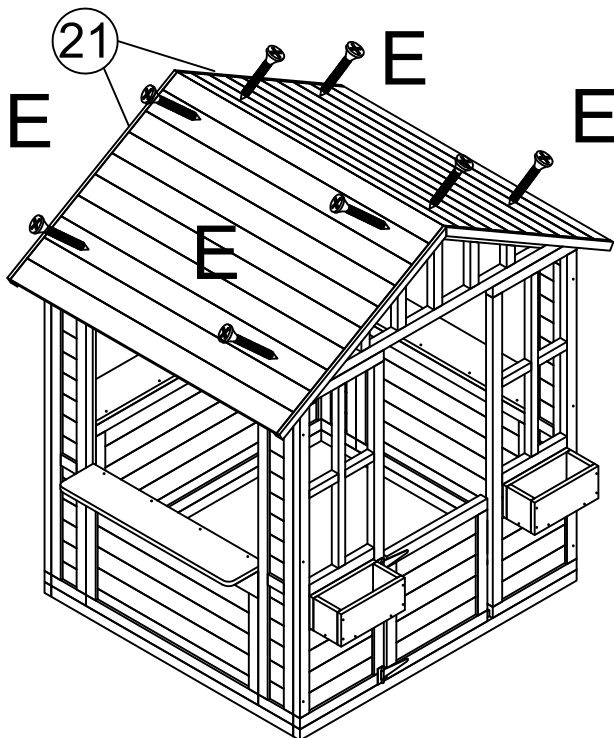

10

E\*4

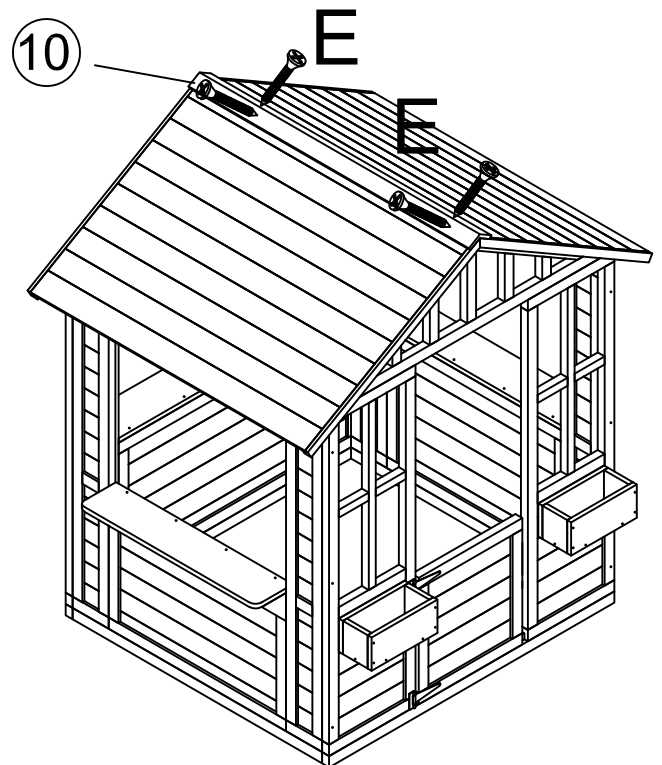

**UK**

If you have any questions, please contact our customer care centre.

Our contact details are below:



0044-800-240-4004



enquiries@mhstar.co.uk

IMPORTER ADDRESS:

MH STAR UK LTD

Unit 27, Perivale Park,

Horsenden lane South

Perivale, UB6 7RH

MADE IN CHINA

**ES**

Si tiene alguna pregunta, comuníquese con nuestro Centro de Atención al Cliente. Nuestros datos de contacto son los siguientes:



0034-931294512



atencioncliente@aosom.es

Importador/Fabricante/REP:

Spanish Aosom, S.L.

C/ Roc Gros, nº 15. 08550, Els Hostalets de Balenyà, Spain.

B66295775

atencioncliente@aosom.es

TEL: 931294512

HECHO EN CHINA

**FR**

Si vous avez la moindre question, veuillez contacter notre centre d'assistance à la clientèle.

Nos coordonnées sont les suivantes:



0033-1-84166106



aosom@mhfrance.fr

Importé par/Fabricant/REP:

MH France

2, rue Maurice Hartmann

92130 Issy-les-Moulineaux

France

Fabriqué en Chine

**PT**

Se tiver alguma dúvida, por favor contacte o nosso Centro de Atendimento ao Cliente. Os nossos dados de contacto são os seguintes:



0034-931294512



info@aosom.pt.

IMPORTADOR:

SPANISH AOSOM, S.L

C.ROC GROS N.15, 08550. ELS HOSTALETES DE BALENYÀ

TEL: 931294512 (SEG-SEX DAS 7:30H ÀS 16:30H)

INFO@AOSOM.PT

WWW.AOSOM.PT

**DE**

Wenn Sie Fragen haben, wenden Sie sich bitte an unser Kundendienstzentrum.

Unsere Kontaktdaten stehen unten:



0049-0(40)-88307530



service@aosom.de

Importeur/Hersteller/REP:

MH Handel GmbH

Wendenstraße 309

D-20537 Hamburg

Germany

IN CHINA HERGESTELLT

**IT**

In caso di dubbio, si prega di contattare il nostro centro assistenza clienti.

I nostri dettagli di contatto sono di seguito:



0039-0249471447



clienti@aosom.it

IMPORTATO DA/Produttore/REP:

AOSOM Italy srl

Centro Direzionale Milanofiori

Strada 1 Palazzo F1

20057 Assago (MI)

P.I.: 08567220960

FATTO IN CINA



**US**

If you have any questions, please contact our customer care center.  
Our contact details are below:



001-877-644-9366



customerservice@aosom.com

Imported by Aosom LLC  
27150 SW Kinsman Rd Wilsonville, OR 97070 USA  
MADE IN CHINA

**CA**

If you have any questions, please contact our customer care center.  
Our contact details are below:

Si vous avez la moindre question, veuillez contacter notre centre d'assistance à la clientèle.  
Nos coordonnées sont les suivantes:



416-792-6088



customerservice@aosom.ca

Imported by Aosom Canada Inc.  
7270 Woodbine Avenue, Unit 307, Markham, Ontario Canada  
L3R 4B9  
MADE IN CHINA

Importé par Aosom Canada Inc.  
7270 Woodbine Avenue, unité 307, Markham, Ontario Canada  
L3R 4B9  
FABRIQUÉ EN CHINE

