

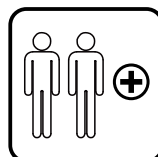

IN230400327V02\_GL

**838-098\_838-098V90**

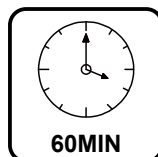
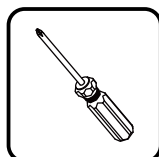
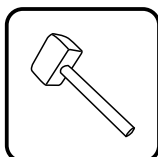
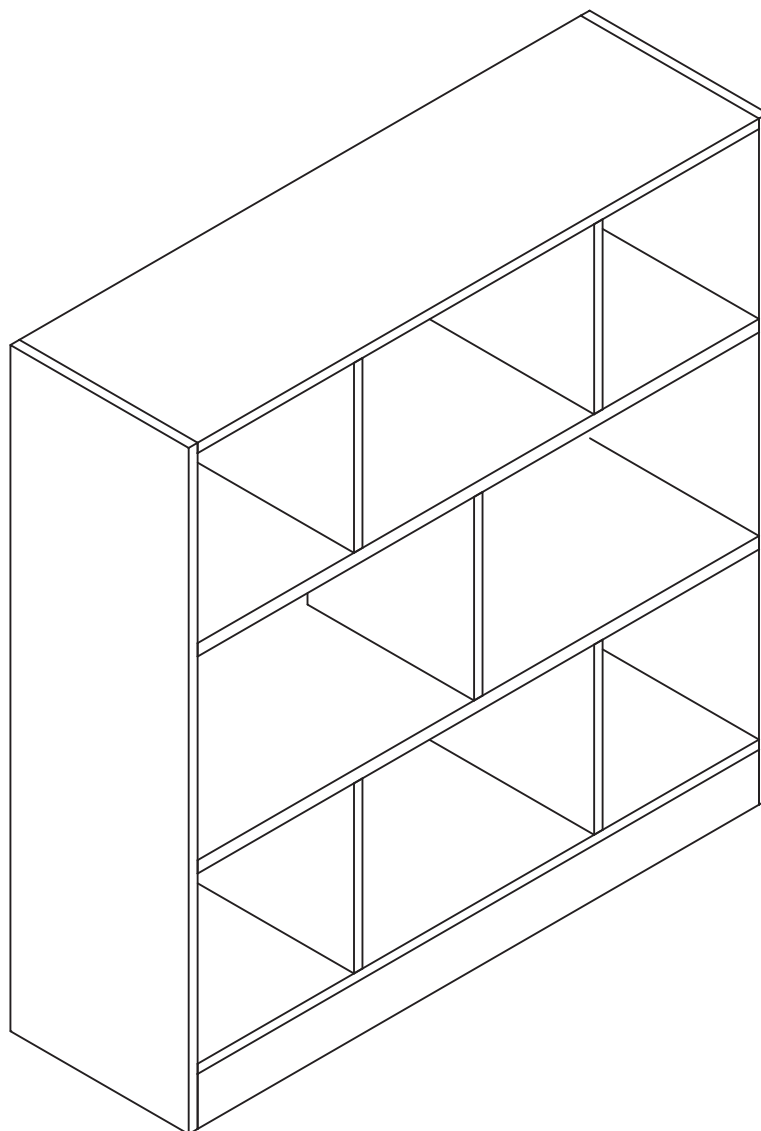

**EN\_IMPORTANT, RETAIN FOR FUTURE REFERENCE: READ CAREFULLY.**

**FR\_IMPORTANT: A LIRE ATTENTIVEMENT ET A CONSERVER POUR VOUS Y REFRERER ULTERIEUREMENT**

**ES\_IMPORTANTE, LEA DETENIDAMENTE Y GUARDE PARA FUTURAS REFERENCIAS.**

**PT\_IMPORTANTE, GARDE PARA FUTURA REFERÊNCIA, LEIA ATENTAMENTE.**

**DE\_WICHTIG! SORFGFÄLTIG LESEN UND FÜR SPÄTERES NACHSCHLAGEN AUFBEWAHREN.**

**IT\_IMPORTANTE, LEGGERE E CONSERVARE QUESTO MANUALE D'ISTRUZIONE PER UN USO FUTURO.**

**EN**

**Dear customer,**

Thank you for purchasing this product. So that your appliance serves you well, please read all the instructions in this user's manual. If you have any questions, please contact our customer care center.

**FR**

**Cher client,**

Nous vous remercions d'avoir acheté ce produit. Afin que vous puissiez profiter pleinement de votre appareil, veuillez lire toutes les instructions de ce manuel d'utilisation. Si vous avez la moindre question, veuillez contacter notre centre d'assistance à la clientèle.

**DE**

**Sehr geehrter Kunde,**

Vielen Dank, dass Sie dieses Produkt erworben haben. Damit Ihr Produkt Ihnen gute Dienste leistet, lesen Sie bitte alle Hinweise in diesem Benutzerhandbuch. Wenn Sie Fragen haben, wenden Sie sich bitte an unser Kundendienstzentrum.

**ES**

**Queridos clientes,**

Gracias por comprar este producto. Para que su electrodoméstico le sirva mejor, lea todas las instrucciones de este manual del usuario. Si tiene alguna pregunta, comuníquese con nuestro Centro de Atención al Cliente.

**PT**

**Caros clientes,**

Obrigado por adquirir este produto. Para que o seu aparelho o sirva melhor, leia todas as instruções deste manual do utilizador. Se tiver alguma dúvida, por favor contacte o nosso Centro de Atendimento ao Cliente.

**IT**

**Caro Cliente,**

Grazie per aver acquistato questo prodotto. Per servirti meglio con questo apparecchio ti prego di leggere tutte le istruzioni in presente manuale utente. In caso di dubbio, si prega di contattare il nostro centro assistenza clienti.

**EN\_Our contact details are below:**



**FR\_Nos coordonnées sont les suivantes:**

**DE\_Unsere Kontaktdaten stehen unten:**

**ES\_Nuestros datos de contacto son los siguientes:**

**PT\_Os nossos dados de contacto são os seguintes:**

**IT\_I nostri dettagli di contatto sono di seguito:**

Country	 Phone	 Email
UK	0044-800-240-4004	enquiries@mhstar.co.uk
DE	0049-(0)40-88307530	service@aosom.de
FR	0033-1-84166106	aosom@mhfrance.fr
ES	0034-931294512	atencioncliente@aosom.es
PT	0034-931294512	info@aosom.pt.
IT	0039-0249471447	clienti@aosom.it
US	001-877-644-9366	customerservice@aosom.com
CA	416-792-6088	customerservice@aosom.ca



**EN\_QUICKFIT:** Tighten quickfit until shoulder is flush with panel. Do not overtighten or undertighten.

**FR\_RACCORD RAPIDE:** Faites serrer le raccord rapide jusqu'à ce que l'épaulement soit parfaitement encastré dans le panneau. Il ne faut ni trop serrer ni insuffisamment serrer.

**ES\_QUICKFIT:** Apriete quickfit hasta que el hombro se descargue con el panel. NO lo sobreapriete ni lo apriete poco.

**PT\_AJUSTE RÁPIDO:** Aperte o ajuste rápido até estar nivelada com o painel. Não apertar demasiado ou excessivamente.

**DE\_QUICKFIT:** Ziehen Sie den Quickfit fest, bis die Schulter mit der Platte bündig ist. Bitte nicht zu fest oder zu schwach anziehen.

**IT\_MONTAGGIO RAPIDO:** Stringere il montaggio rapido fino a quando la spalla è a filo con il pannello, non stringere troppo o troppo poco.

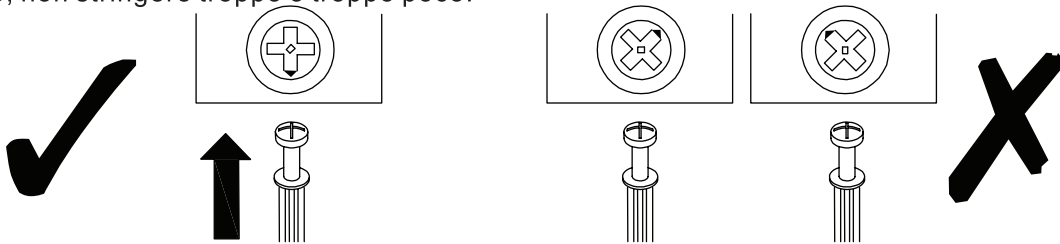

**EN\_CAM LOCK:** When fitting cam lock, ensure starting position is correct before you insert connecting quickfit.

**FR\_SERRURE BATTEUSE:** Avant d'insérer la serrure batteuse, veillez à la bonne orientation avant d'insérer le raccord rapide.

**ES\_CIERRE DE LA CÁMARA:** Cuando instale el cierre de la cámara, asegúrese de que la posición de inicio es correcta antes de que inserte el quickfit conector.

**PT\_BLOQUEIO:** Ao instalar o bloqueio, assegurar-se de que a posição inicial está correcta antes de inserir o encaixe de ligação rápida.

**DE\_CAM-LOCK:** Achten Sie bei der Montage des Cam-Locks auf die richtige Ausgangsposition, bevor Sie den Quickfit einsetzen.

**IT\_BLOCCAGGIO A CAMMA:** Quando si monta il bloccaggio a camma, assicurarsi che la posizione iniziale sia corretta prima di inserire il montaggio rapido di collegamento.

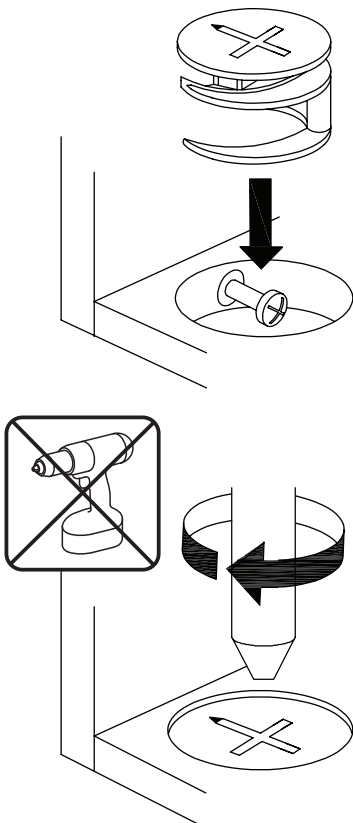

**EN\_Quickfit head should be in the centre of the cam lock when the two panels are joined.**

Cam lock should be inserted before quickfit.

**FR\_Lorsque les deux panneaux sont assemblés, la tête du raccord rapide doit reposer au centre de la serrure batteuse.**

Il faut insérer la serrure batteuse avant le raccord rapide.

**ES\_El cabezal del quickfit debe estar en el centro del cierre de la cámara cuando se unan los dos paneles.**

Se debe insertar el cierre de la cámara antes que el quickfit.

**PT\_A cabeça de ajuste rápido deve estar no centro da fechadura quando os dois painéis estão unidos.**

A fechadura de cames deve ser inserida antes de ser rápida.

**DE\_Der Quickfit-Kopf sollte sich in der Mitte des Cam-Locks befinden, wenn die beiden Platten zusammengefügt sind.**

Der Cam-Lock sollte vor dem Quickfit eingesetzt werden.

**IT\_La testa del montaggio rapido deve trovarsi al centro del bloccaggio a camma quando i due pannelli sono uniti.**

Il Bloccaggio a Camma deve essere inserito prima del montaggio rapido.

**EN\_Turn cam lock clockwise to tighten.**

**FR\_Faites tourner la serrure batteuse dans le sens des aiguilles d'une montre pour la resserrer.**

**ES\_Gire el cierre de la cámara en sentido horario para apretarlo.**

**PT\_Rodar o bloqueio no sentido dos ponteiros do relógio para o apertar.**

**DE\_Drehen Sie den Cam-Lock im Uhrzeigersinn, um ihn festzuziehen.**

**IT\_Ruotare il bloccaggio a camma in senso orario per stringere.**

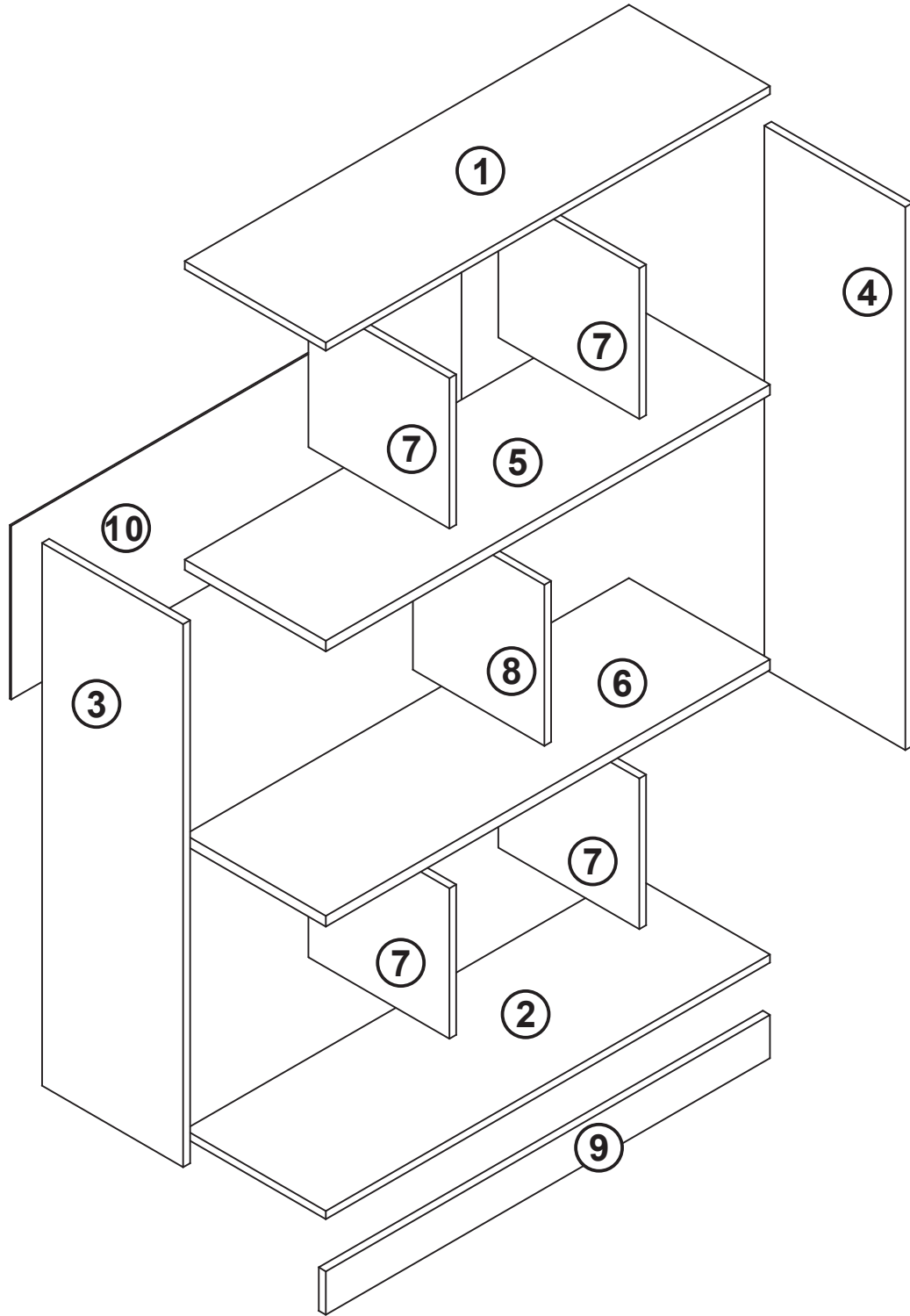

**PARTS**

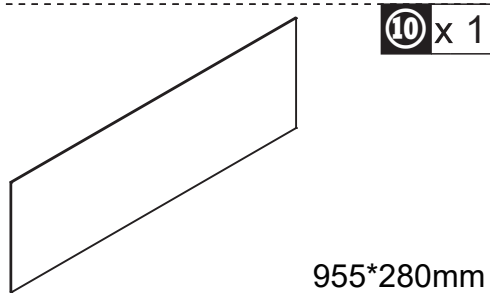
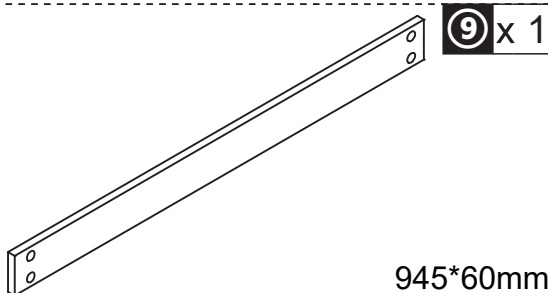
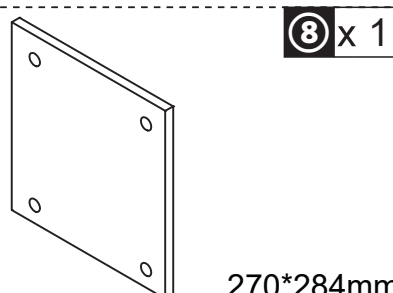
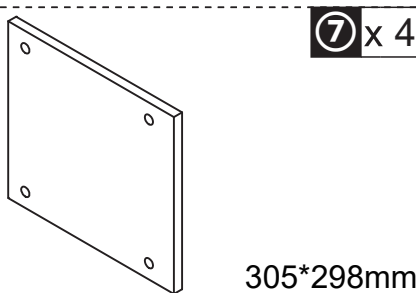
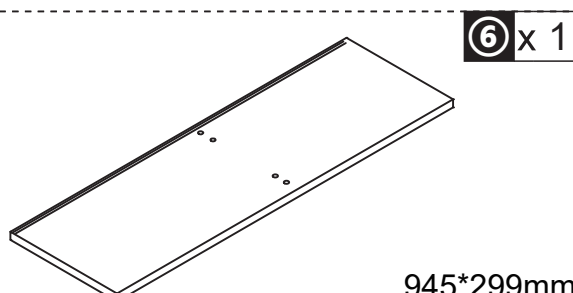
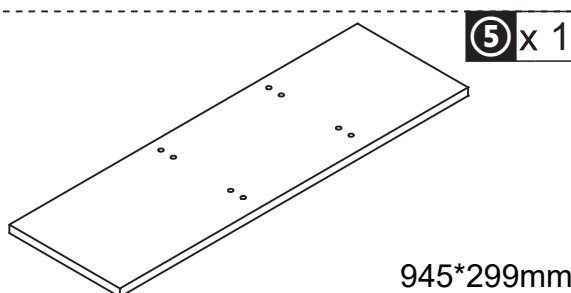
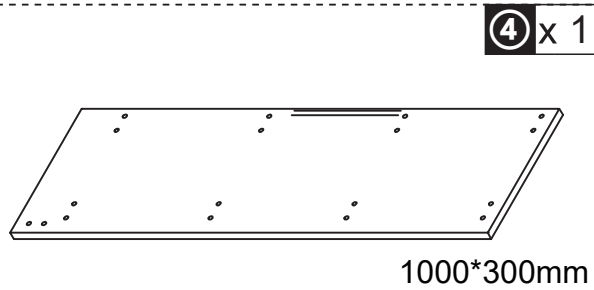
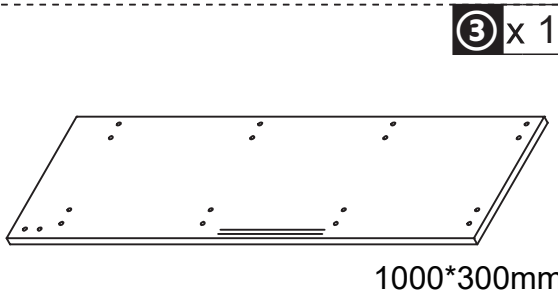
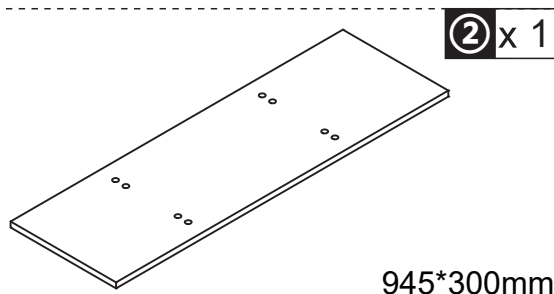
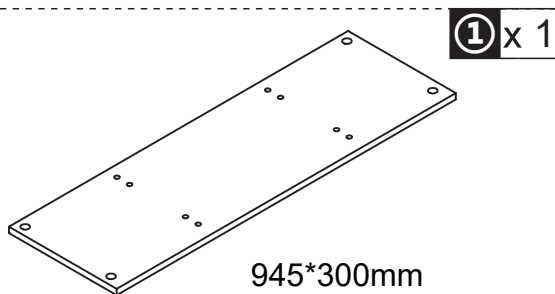

**HARDWARE**

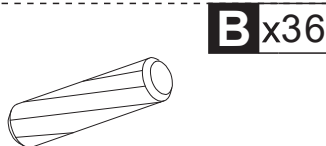
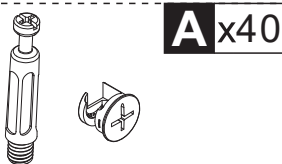

A-4pcs



B-4pcs



T-4pcs

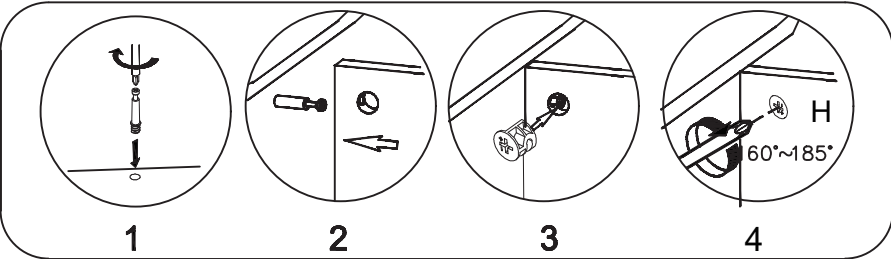
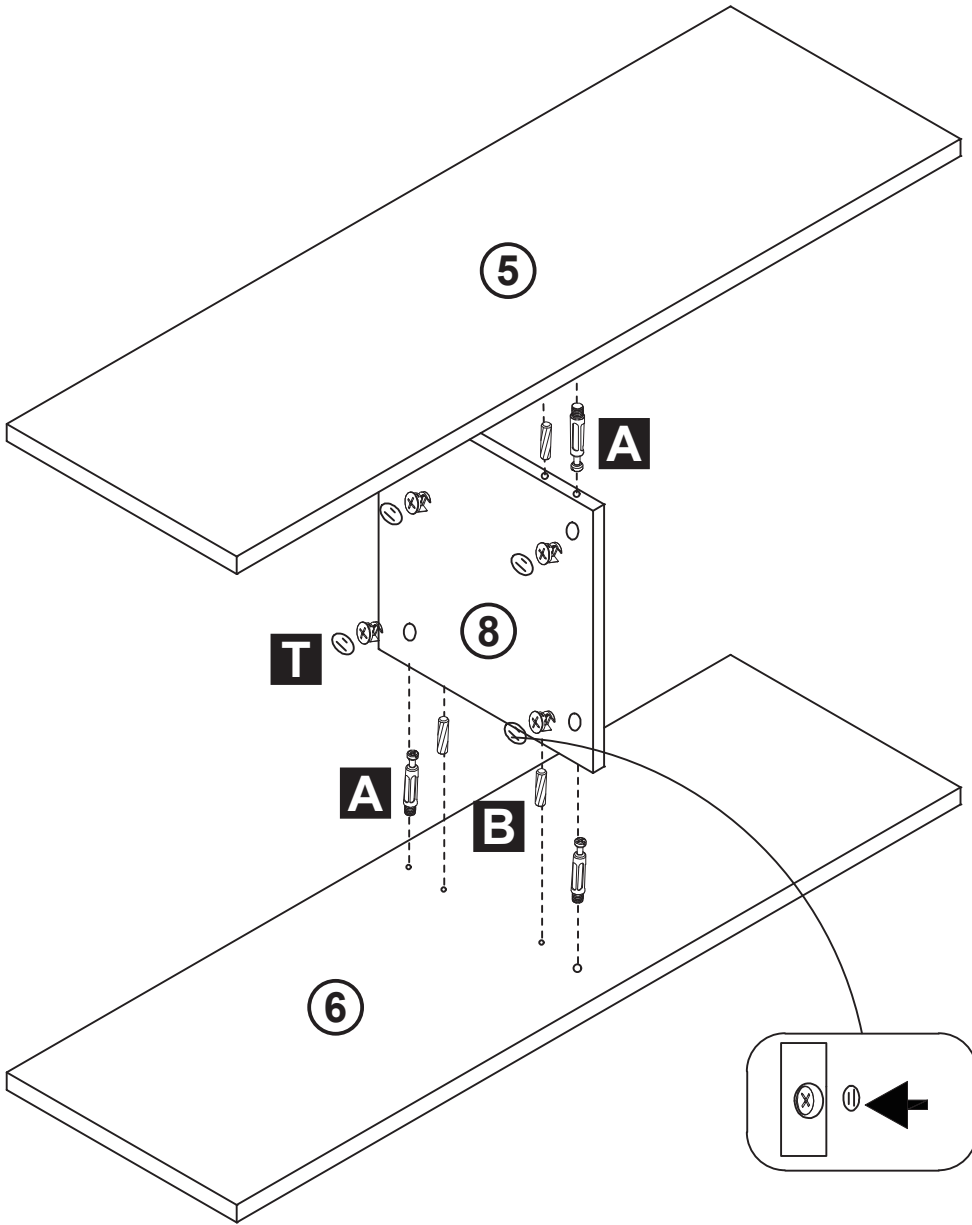

A-8pcs



B-8pcs



T-8pcs

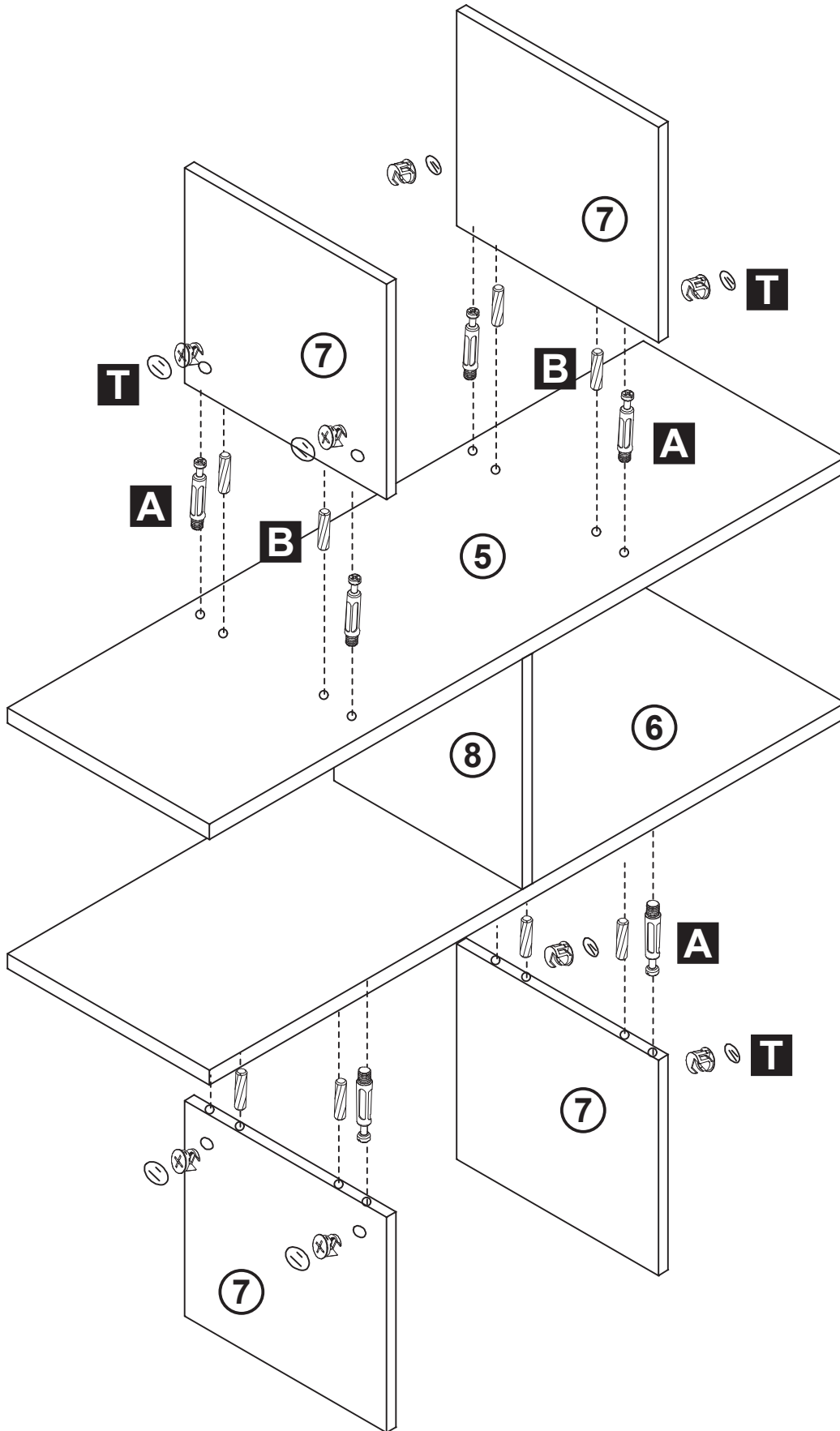

A-8pcs



B-8pcs



T-8pcs

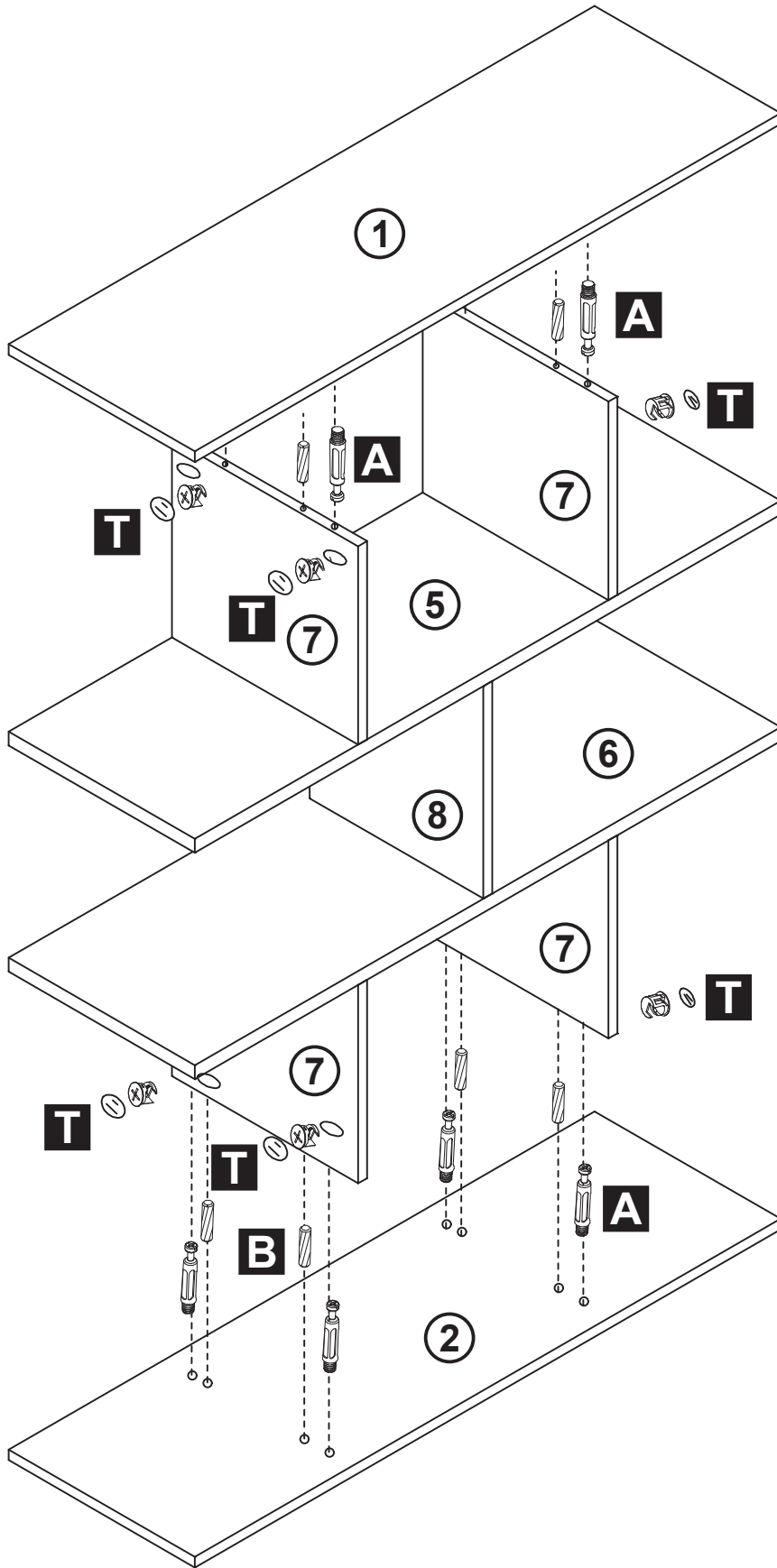





A-10pcs



B-8pcs

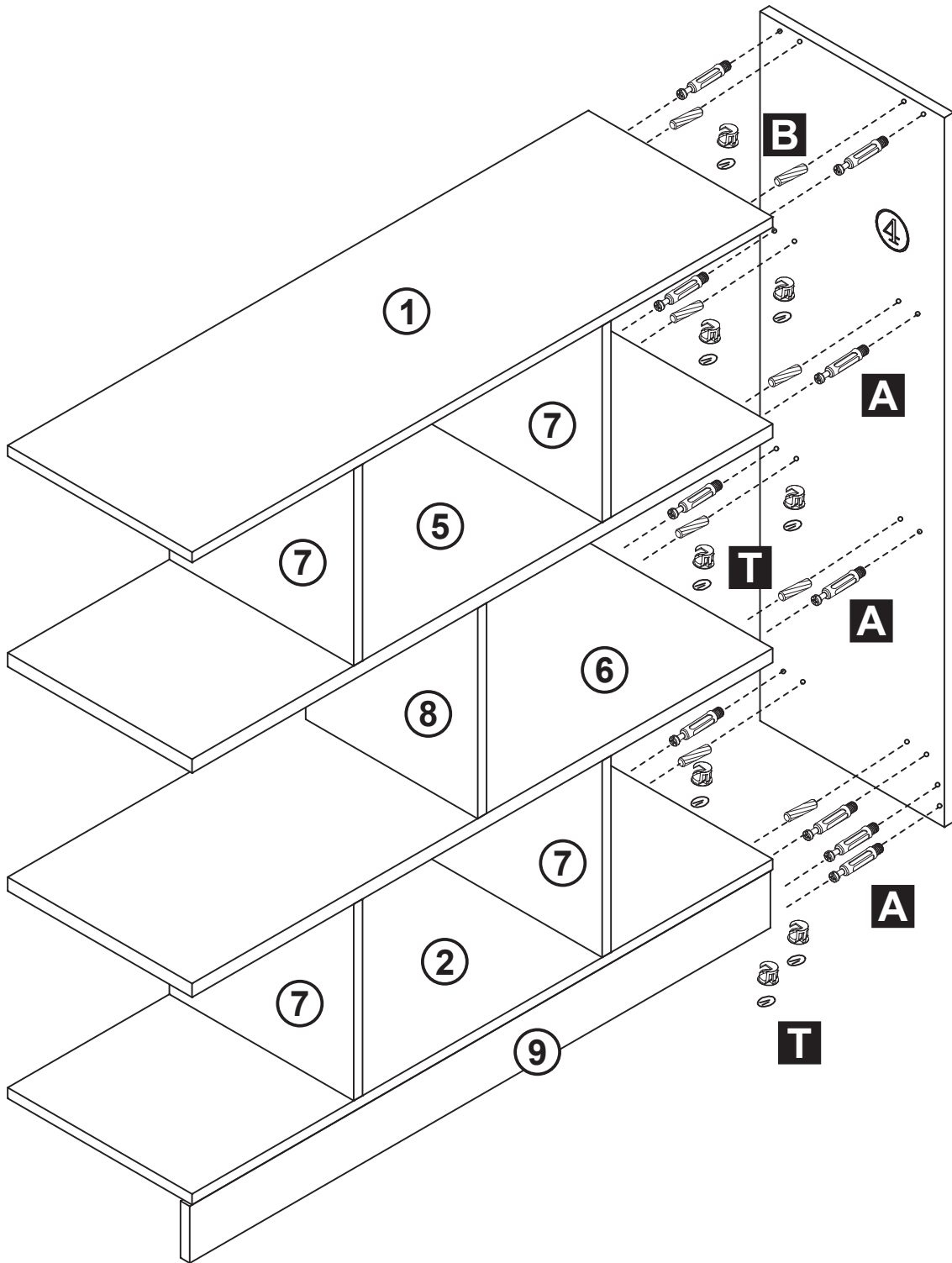

T-10pcs



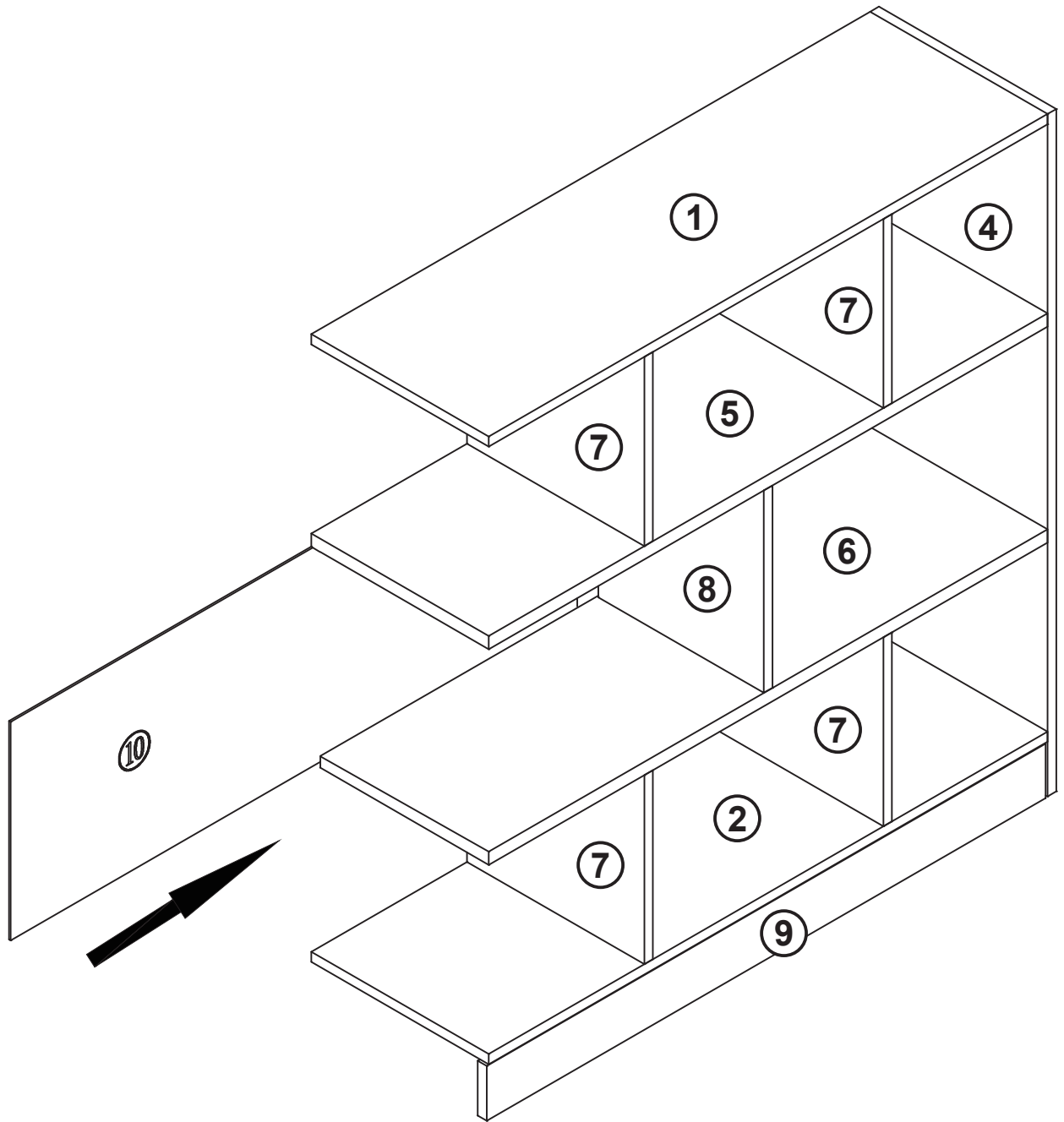



A-10pcs



B-8pcs

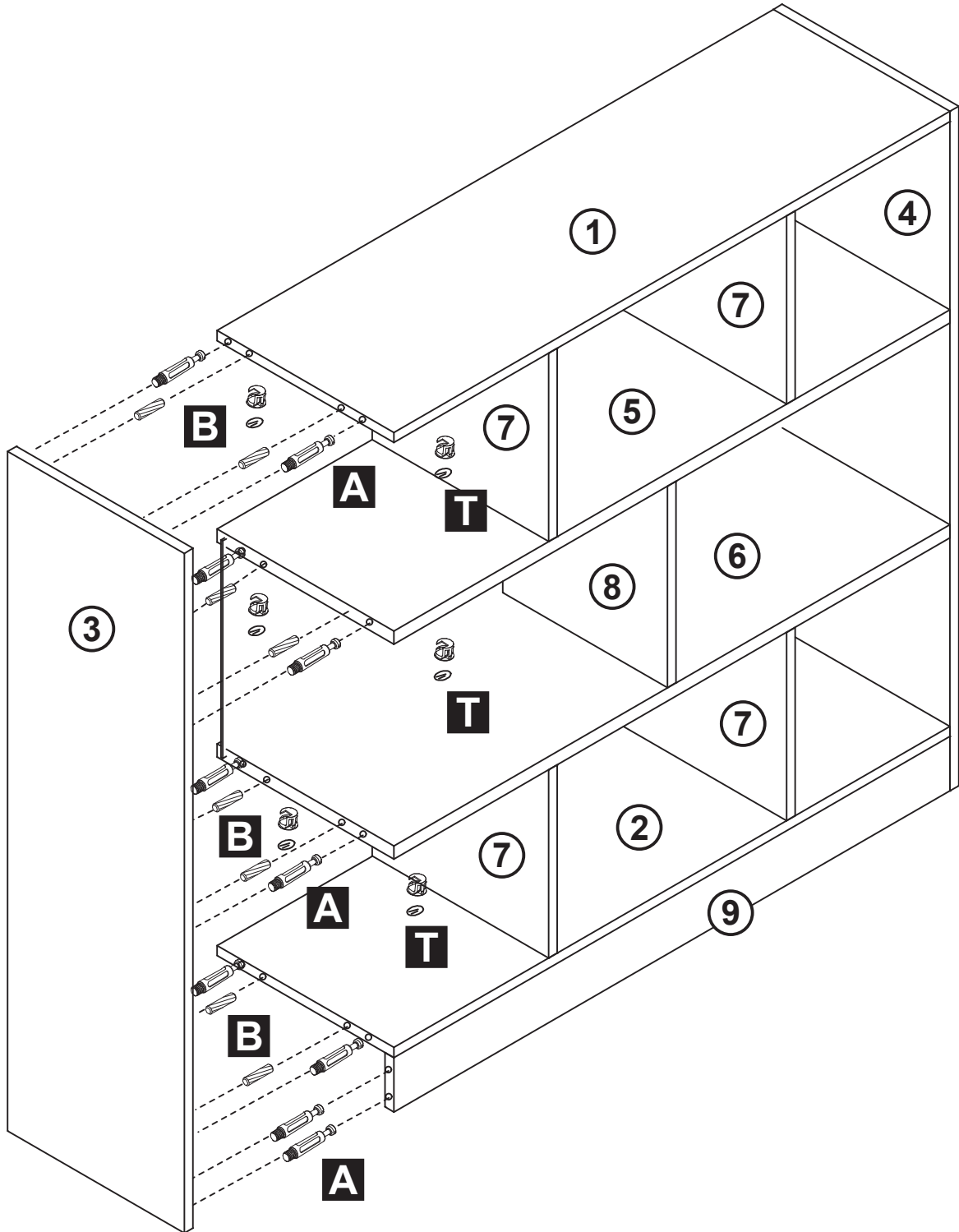

T-10pcs



M-4pcs



D-4pcs

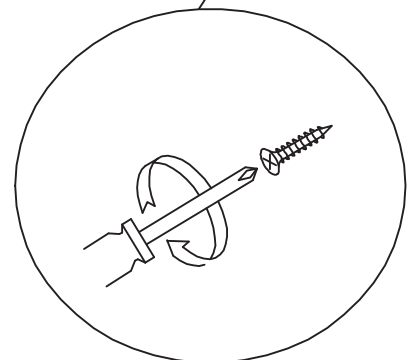
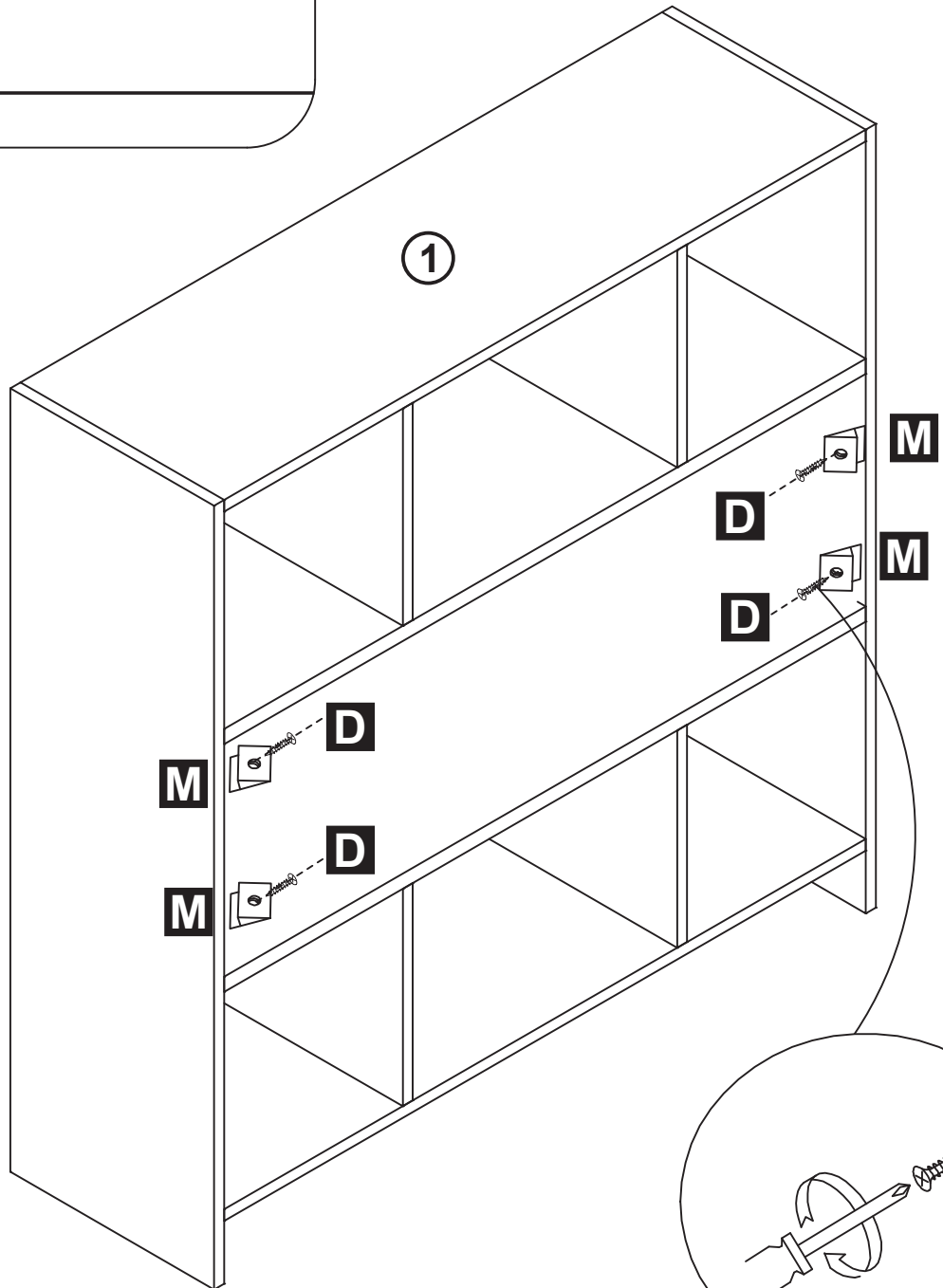
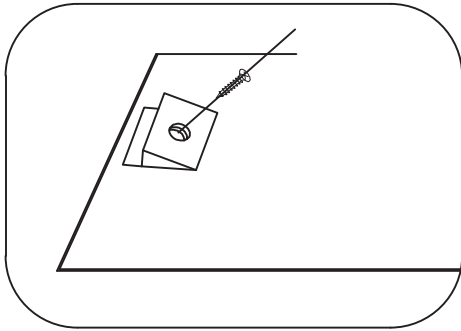

w-1pcs



Done

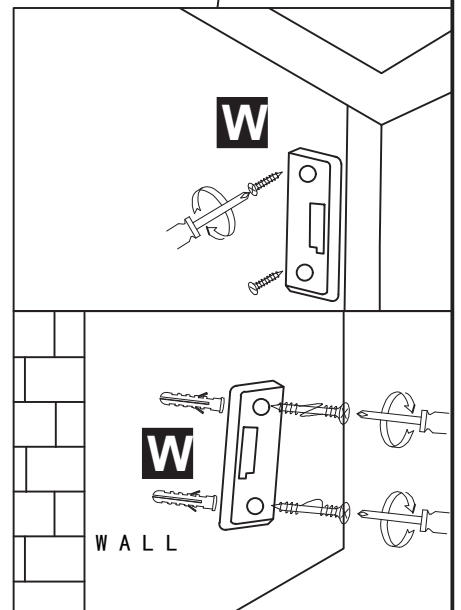
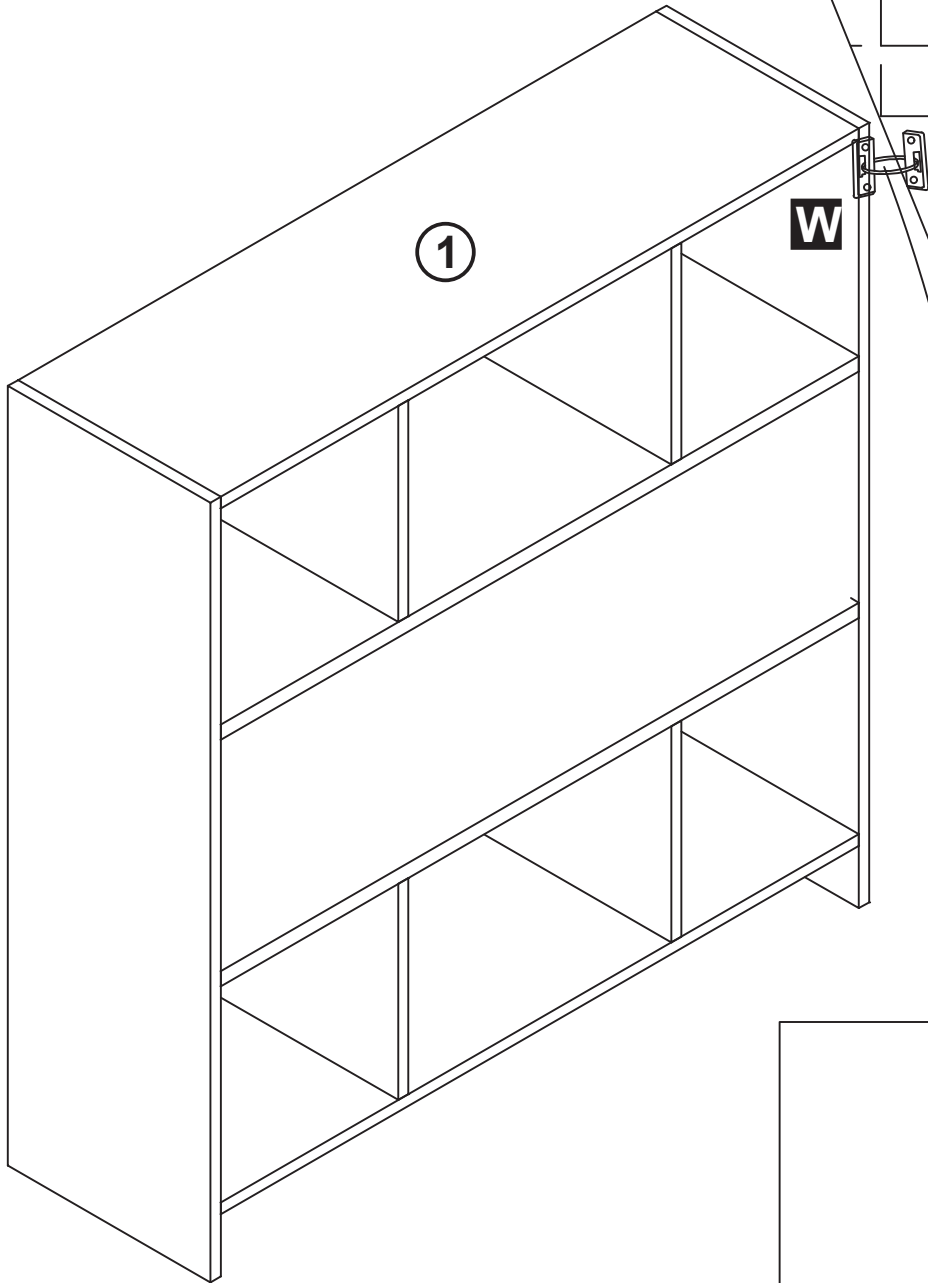

## US\_ IMPORTER:

Imported by Aosom LLC  
27150 SW Kinsman Rd Wilsonville, OR 97070 USA  
MADE IN CHINA

## CA\_ IMPORTER / IMPORTÉ PAR:

Imported by Aosom Canada Inc.  
7270 Woodbine Avenue, Unit 307, Markham, Ontario Canada L3R 4B9  
MADE IN CHINA

Importé par Aosom Canada Inc.  
7270 Woodbine Avenue, unité 307, Markham, Ontario Canada L3R 4B9  
Fabriqué en Chine

## UK\_ IMPORTER:

MH STAR UK LTD  
Unit 27, Perivale Park, Horsenden lane South  
Perivale, UB6 7RH  
MADE IN CHINA

## DE\_ IMPORTATEUR:

MH Handel GmbH  
Wendenstraße 309  
D-20537 Hamburg  
Germany  
IN CHINA HERGESTELLT

## FR\_ IMPORTÉ PAR:

MH France  
2, rue Maurice Hartmann  
92130 Issy-les-Moulineaux  
France  
Fabriqué en Chine



FR

Pensez à  
donner ou recycler.



Association

ou



Magasin

ou



Déchèterie

<https://quefairedemesdechets.fr>

## IT\_ IMPORTATO:

AOSOM Italy srl  
Centro Direzionale Milanofiori  
Strada 1 Palazzo F1  
20057 Assago (MI)  
P.I.: 08567220960  
FATTO IN CINA

## ES/PT\_ IMPORTADOR:

SPANISH AOSOM, S.L.  
C/ ROC GROS, N° 15. 08550, ELS HOSTALETS DE  
BALENYÀ, SPAIN.  
B66295775  
WWW.AOSOM.ES  
ATENCIONCLIENTE@AOSOM.ES  
TEL: 931294512  
HECHO EN CHINA

SPANISH AOSOM, S.L.  
C.ROC GROS N.15, 08550. ELS HOSTALETS DE BALENYÀ  
TEL: 931294512 (SEG-SEX DAS 7:30H ÀS 16:30H)  
INFO@AOSOM.PT  
WWW.AOSOM.PT