

Vinsetto

IN230500045V01_GL

838-396V80_838-396V90_838-396V91

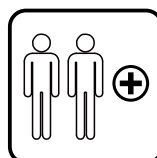
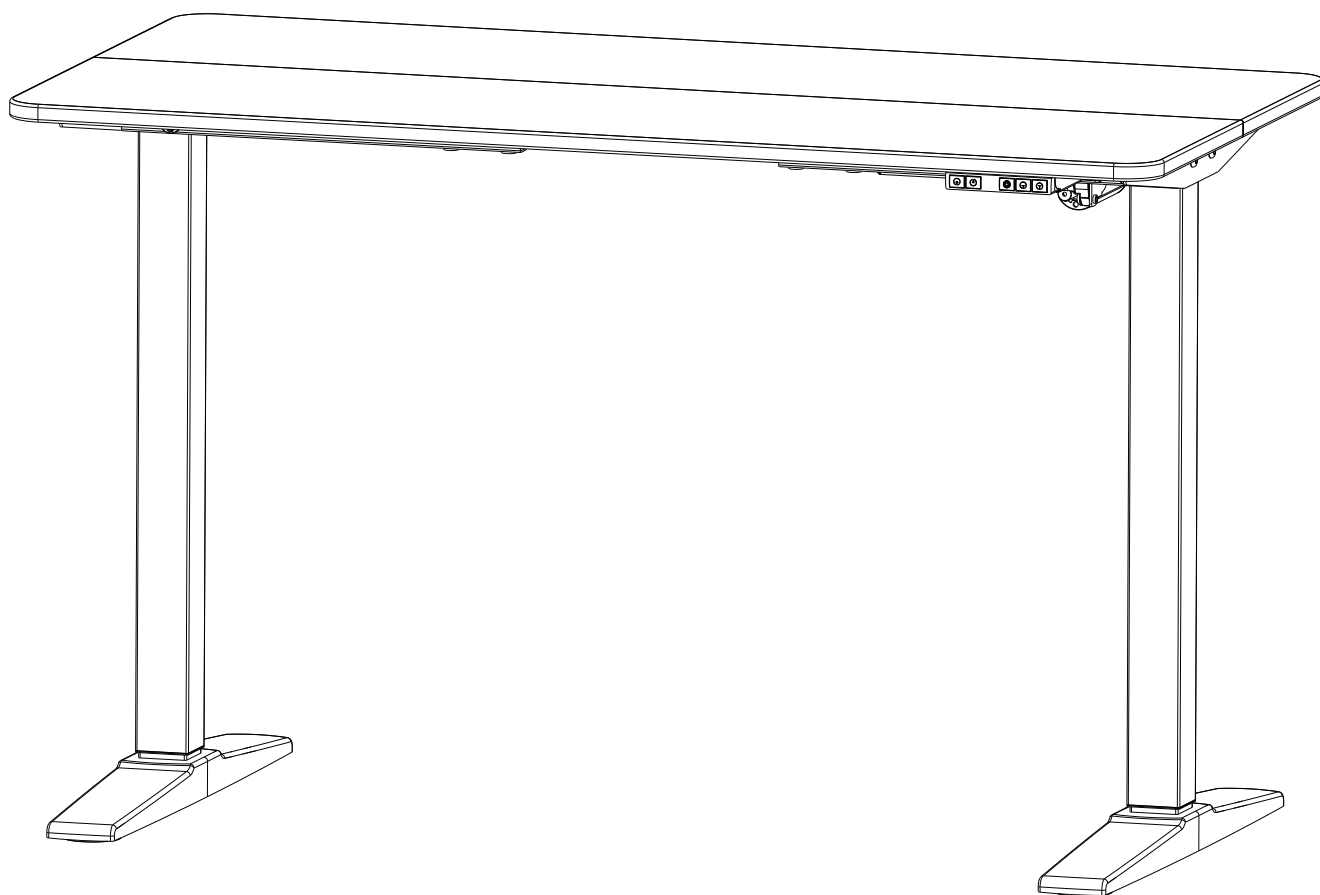

UK
CA **CE** **€**

EN_ IMPORTANT, RETAIN FOR FUTURE REFERENCE: READ CAREFULLY.

FR_ IMPORTANT: A LIRE ATTENTIVEMENT ET A CONSERVER POUR VOUS Y REFRERER ULTERIEUREMENT.

ES_ IMPORTANTE, LEA DETENIDAMENTE Y GUARDE PARA FUTURAS REFERENCIAS.

PT_ IMPORTANTE, GARDE PARA FUTURA REFERÊNCIA, LEIA ATENTAMENTE.

DE_ „WICHTIG! SORGFÄLTIG LESEN UND FÜR SPÄTER NACHSCHLAGEN AUFBEWAHREN.“

IT_ IMPORTANTE, LEGGERE E CONSERVARE QUESTO MANUALE D'ISTRUZIONE PER UN USO FUTURO.

EN

Dear customer,

Thank you for purchasing this product. So that your appliance serves you well, please read all the instructions in this user's manual. If you have any questions, please contact our customer care center.

FR

Cher client,

Nous vous remercions d'avoir acheté ce produit. Afin que vous puissiez profiter pleinement de votre appareil, veuillez lire toutes les instructions de ce manuel d'utilisation. Si vous avez la moindre question, veuillez contacter notre centre d'assistance à la clientèle.

DE

Sehr geehrter Kunde,

Vielen Dank, dass Sie dieses Produkt erworben haben. Damit Ihr Gerät Ihnen gute Dienste leistet, lesen Sie bitte alle Hinweise in diesem Benutzerhandbuch. Wenn Sie Fragen haben, wenden Sie sich bitte an unser Kundendienstzentrum.

ES

Queridos clientes,

Gracias por comprar este producto. Para que su electrodoméstico le sirva mejor, lea todas las instrucciones de este manual del usuario. Si tiene alguna pregunta, comuníquese con nuestro Centro de Atención al Cliente.

PT

Caros clientes,

Obrigado por adquirir este produto. Para que o seu aparelho o sirva melhor, leia todas as instruções deste manual do utilizador. Se tiver alguma dúvida, por favor contacte o nosso Centro de Atendimento ao Cliente.

IT

Caro Cliente,

Grazie per aver acquistato questo prodotto. Per servirti meglio con questo apparecchio ti prego di leggere tutte le istruzioni in presente manuale utente. In caso di dubbio, si prega di contattare il nostro centro assistenza clienti.

EN_ Our contact details are below:



FR_ Nos coordonnées sont les suivantes:

DE_ Unsere Kontaktdaten stehen unten:

ES_ Nuestros datos de contacto son los siguientes:

PT_ Os nossos dados de contacto são os seguintes:

IT_ I nostri dettagli di contatto sono di seguito:

Country	 Phone	 Email
UK	0044-800-240-4004	enquiries@mhstar.co.uk
DE	0049-0(40)-88307530	service@aosom.de
FR	0033-1-84166106	aosom@mhfrance.fr
ES	0034-931294512	atencioncliente@aosom.es
PT	0034-931294512	info@aosom.pt.
IT	0039-0249471447	clienti@aosom.it
US	001-877-644-9366	customerservice@aosom.com
CA	416-792-6088	customerservice@aosom.ca

CAUTION / INFORMATION

IMPORTANT: Please read this manual carefully.

1. This height adjustable desk has electric motors and is designed for use in dry work areas only
2. Make sure no obstacles are in the desk's path.
Make sure the desktop is not touching any walls.
Make sure all cords are appropriate length to accommodate the change in height.
3. Do not sit or stand on the desk frame.
Do not crawl or lie under the desk frame.
4. Do not place any objects taller than 20" underneath the desk.
5. Do not open any of the components – the legs, control box or switch. There is a risk of injury and electric shock.
6. Make sure that the power supply is between 100v and 240v before plugging the control box into it.
7. Under no circumstances does the manufacturer accept warranty claims or liability claims for damages caused from improper use or handling of the desk frame.

SAFETY INSTRUCTIONS

1. Keep all electrical components away from liquids. There is a risk of injury and electric shock.
2. Keep children away from electric height adjustable desks, control units and memory controller. There is a risk of injury and electric shock.
3. People who do not have the knowledge of the product or have reduced physical or mental abilities can't use the product. Unless they are under surveillance or they have been thoroughly instructed in the use of the apparatus.
4. Before trouble shooting
 - Stop the desk legs.
 - Switch off the power supply and pull out the mains plug
 - Remove everything from the desk top which might contribute weight.
5. Before start-up:
 - Make sure that the power supply is between 100v and 240v before plugging the control box into it.
 - The individual parts must be connected before the control box is connected to the main power supply.
6. During operation:
 - If the control box makes unusual noises or smells, switch off the main power immediately.
 - Take care that the cables are not damaged.
 - Unplug the main power cable on mobile equipment before it is moved.

ATTENTION/INFORMATIONS

IMPORTANT : Veuillez lire attentivement ce manuel.

1. Ce bureau réglable en hauteur est équipé de moteurs électriques et est conçu pour être utilisé dans des zones de travail sèches uniquement
2. S'assurer qu'aucun obstacle ne se trouve sur la trajectoire du bureau.
S'assurer que le bureau ne heurte aucun mur.
S'assurer que tous les cordons sont d'une longueur appropriée pour s'adapter au changement de hauteur.
3. Ne pas s'asseoir ou se tenir debout sur le cadre du bureau.
Ne pas se glisser ou s'allonger sous le cadre du bureau.
4. Ne pas poser d'objets d'une hauteur supérieure à 20 pouces sous le bureau.
5. N'ouvrez aucun des composants - les pieds, le boîtier de commande ou l'interrupteur - au risque de vous blesser ou de vous électrocuter.
6. S'assurer que l'alimentation électrique est comprise entre 100 et 240 V avant d'y brancher le boîtier de commande.
7. Le fabricant n'accepte en aucun cas les réclamations au titre de la garantie ou de la responsabilité pour les dommages causés par une utilisation ou une manipulation incorrecte du cadre de bureau.

CONSIGNES DE SÉCURITÉ

1. Garder tous les composants électriques à l'écart des liquides ; ils présentent un risque de blessure et d'électrocution.
2. Tenir les enfants à l'écart des bureaux électriques réglables en hauteur, des unités de commande et du contrôleur de mémoire.
Il subsiste un risque de blessure et d'électrocution.
3. Les personnes qui n'ont pas la connaissance du produit ou dont les capacités physiques ou mentales sont réduites ne peuvent pas utiliser le produit.
Sauf dans les cas où elles sont sous surveillance ou si elles ont été instruites de manière approfondie sur l'utilisation de l'appareil.
4. Avant de procéder au dépannage
 - immobiliser les pieds du bureau.
 - Couper l'alimentation électrique et débrancher la fiche secteur.
 - Retirer du bureau tout ce qui peut contribuer au poids de l'appareil.
5. Avant la mise en service :
 - S'assurer que l'alimentation électrique est comprise entre 100 et 240 V avant d'y brancher le boîtier de commande.
 - . Les différents éléments doivent être connectés avant que le boîtier de contrôle ne soit connecté à l'alimentation principale.
6. Pendant le fonctionnement :
 - Si le boîtier de commande émet des bruits ou des odeurs inhabituels, couper immédiatement l'alimentation principale.
 - Veiller à ce que les câbles ne soient pas endommagés.
 - Débrancher le câble d'alimentation principal de l'équipement mobile avant de le déplacer.

ADVERTENCIA / INFORMACIÓN

IMPORTANTE: Lea atentamente este manual.

1. Este escritorio de altura ajustable tiene motores eléctricos y está diseñado para usarse únicamente en áreas de trabajo secas.
2. Asegúrese de que no haya obstáculos en el camino del escritorio.
Asegúrese de que el escritorio no toque ninguna pared.
3. Asegúrese de que todos los cables tengan la longitud adecuada para adaptarse al cambio de altura.
3. No se siente ni se pare en el marco del escritorio. No se arrastre ni se acueste debajo del marco del escritorio.
4. No coloque ningún objeto de más de 20" (50 cm) debajo del escritorio.
5. No abra ninguno de los componentes: las patas, la caja de control o el interruptor. Existe riesgo de lesiones y descargas eléctricas.
6. Asegúrese de que la fuente de alimentación esté entre 100v y 240v antes de enchufar la caja de control.
7. El fabricante no aceptará en ningún caso reclamaciones de garantía o de responsabilidad por los daños causados por el uso o la manipulación inadecuados de la estructura del escritorio.

INSTRUCCIONES DE SEGURIDAD

1. Mantenga todos los componentes eléctricos alejados de los líquidos. Existe riesgo de lesiones y descargas eléctricas.
2. Mantenga a los niños alejados de los escritorios eléctricos de altura ajustable, las unidades de control y el controlador de memoria. Existe riesgo de lesiones y descargas eléctricas.
3. Las personas que no tengan el conocimiento del producto o tengan capacidades físicas o mentales reducidas no pueden usar el producto.
A menos que estén bajo vigilancia o hayan sido instruidos minuciosamente en el uso del aparato.
4. Antes de solucionar el problema:
 - Detenga las patas del escritorio.
 - Apague la fuente de alimentación y desconecte el enchufe de la corriente.
 - Retire todo lo que pueda contribuir al peso de la superficie del escritorio.
5. Antes de la puesta en marcha:
 - Asegúrese de que la fuente de alimentación esté entre 100v y 240v antes de enchufar la caja de control.
 - Las piezas individuales deben conectarse antes de conectar la caja de control a la fuente de alimentación principal.
6. Durante el funcionamiento:
 - Si la caja de control hace ruidos u olores inusuales, desconecte la alimentación principal inmediatamente.
 - Tenga cuidado de no dañar los cables.
 - Desconecte el cable de alimentación principal del equipo móvil antes de moverlo.

CUIDADO / INFORMAÇÕES

IMPORTANTE: Leia atentamente este manual

1. Esta secretária de altura ajustável tem motores elétricos e foi concebida para ser utilizada apenas em áreas de trabalho secas.
2. Certifique-se de que não existem obstáculos no caminho da secretária. Certifique-se de que a secretária não está a tocar em nenhuma parede.
Certifique-se de que todos os cabos têm o comprimento adequado para acomodar a mudança de altura.
3. Não se sente nem fique de pé sobre a estrutura da secretária. Não rasteje nem se deite debaixo da estrutura da secretária.
4. Não coloque objetos com altura superior a 20" (50 cm) debaixo da secretária.
5. Não abra nenhum dos componentes - os pés, a caixa de controlo ou o interruptor. Existe o risco de ferimentos e choques elétricos.
6. Certifique-se de que a fonte de alimentação está entre 100 e 240 V antes de ligar a caixa de controlo à mesma.
7. O fabricante não aceita, em circunstância alguma, pedidos de garantia ou de responsabilidade por danos causados por uma utilização ou manuseamento incorrecto da estrutura da secretária.

INSTRUÇÕES DE SEGURANÇA

1. Mantenha todos os componentes elétricos afastados de líquidos. Existe o risco de ferimentos e choques elétricos.
2. Mantenha as crianças afastadas da secretária elétrica de altura ajustável, das unidades de controlo e do controlador de memória.
Existe o risco de ferimentos e de choque elétrico.
3. As pessoas que não têm conhecimentos sobre o produto ou que têm capacidades físicas ou mentais reduzidas não podem utilizar o produto.
A menos que estejam sob vigilância ou tenham recebido instruções completas sobre a utilização do aparelho.
4. Antes da resolução de problemas
 - Parar os pés da secretária.
 - Desligar a alimentação elétrica e retirar a ficha de alimentação
 - Retire da bancada da secretária tudo o que possa contribuir para o seu peso.
5. Antes do arranque:
 - Certifique-se de que a fonte de alimentação está entre 100V e 240V antes de ligar a caixa de controlo à mesma.
 - As peças individuais devem ser ligadas antes de a caixa de controlo ser ligada à fonte de alimentação principal.
6. Durante o funcionamento:
 - Se a caixa de controlo emitir ruídos ou cheiros anormais, desligue imediatamente a alimentação principal.
 - Tenha cuidado para não danificar os cabos.
 - Desligue o cabo de alimentação principal do equipamento móvel antes de o deslocar.

VORSICHT/DATEN

WICHTIG: Bitte lesen Sie dieses Handbuch sorgfältig durch.

1. Dieser höhenverstellbare Tisch verfügt über Elektromotoren und ist nur für die Verwendung in trockenen Arbeitsbereichen vorgesehen
2. Stellen Sie sicher, dass sich keine Hindernisse im Weg des Tisches befinden.
Stellen Sie sicher, dass die Tischplatte keine Wände berührt.
Vergewissern Sie sich, dass alle Kabel die richtige Länge haben, um die Höhenverstellung zu ermöglichen.
3. Setzen oder stellen Sie sich nicht auf den Tischrahmen.
Kriechen oder legen Sie sich nicht unter den Tischrahmen.
4. Stellen Sie keine Gegenstände, die höher als 20 Zoll sind, unter den Tisch.
5. Öffnen Sie keine Bestandteile -Die Füße, die Steuerung oder den Schalte.
Es besteht Verletzungs- und Stromschlaggefahr.
6. Vergewissern Sie sich, dass das Netzteil zwischen 100 V und 240 V liegt, bevor Sie die Steuereinheit einstecken.
7. Der Hersteller übernimmt unter keinen Umständen Garantie- oder Haftungsansprüche für Schäden, die durch unsachgemäßen Gebrauch oder Handhabung des Tischrahmens entstehen.

SICHERHEITSHINWEISE

1. Halten Sie alle elektrischen Komponenten von Flüssigkeiten fern.
Es besteht Verletzungs- und Stromschlaggefahr.
2. Halten Sie Kinder von elektrisch höhenverstellbaren Tischen, Steuereinheiten und der Memory-Steuerung fern.
Es besteht Verletzungs- und Stromschlaggefahr.
3. Personen, die nicht mit dem Produkt vertraut sind oder eingeschränkte körperliche oder geistige Fähigkeiten haben, dürfen das Produkt nicht benutzen.
Es sei denn, sie werden beaufsichtigt oder sind gründlich in die Verwendung des Gerätes eingewiesen worden.
4. Vor der Fehlersuche die Tischbeine stoppen.
 - Schalten Sie das Netzteil aus und ziehen Sie den Netzstecker
 - Entfernen Sie alles von der Tischplatte, was Gewicht verursachen könnte.
5. Vor dem Anfang:
 - Vergewissern Sie sich, dass das Netzteil zwischen 100 V und 240 V liegt, bevor Sie die Steuereinheit einstecken.
 - Die Einzelteile müssen verbunden werden, bevor die Steuereinheit an das Stromnetz verbunden wird.
6. Während des Betriebs:
 - Wenn die Steuereinheit ungewöhnliche Geräusche oder Gerüche von sich gibt, schalten Sie sofort das Stromnetz aus.
 - Achten Sie darauf, dass die Kabel nicht beschädigt werden.
 - Ziehen Sie bei mobilen Geräten das Stromnetzkabel ab, bevor es bewegt wird.

ATTENZIONE/INFORMAZIONI

Leggere attentamente questo manuale.

1. Questa scrivania regolabile in altezza è dotata di motori elettrici ed è progettata solo per l'uso in aree di lavoro completamente asciutte.
2. Assicurarsi che non vi siano ostacoli in mezzo alla scrivania.
Assicurarsi che la scrivania non tocchi le pareti.
Assicurarsi che tutti i cavi siano di lunghezza adeguata per adattarsi alla variazione di altezza.
3. Non sedersi o stare in piedi sulla struttura della scrivania.
Non strisciare o sdraiarsi sotto la struttura della scrivania.
4. Non disporre sotto la scrivania oggetti di altezza superiore a 50 cm.
5. Non aprire i componenti (gambe, scatola da incasso o interruttore) per evitare il rischio di lesioni e scosse elettriche.
6. Assicurarsi che l'alimentazione sia compresa tra 100 e 240 V prima di collegare la scatola da incasso.
7. In nessun caso il produttore accetta richieste di garanzia o di responsabilità per danni causati dall'uso o dalla manipolazione impropria della scrivania.

ISTRUZIONI DI SICUREZZA

1. Tenere tutti i componenti elettrici lontani dai liquidi per evitare il rischio di lesioni e scosse elettriche.
2. Tenere i bambini lontani dalle scrivanie elettriche, dalle unità di controllo e dal controller di memoria. Il rischio di lesioni e scosse elettriche è concreto.
3. Le persone che non conoscono il prodotto o che hanno ridotte capacità fisiche o mentali non possono utilizzare il prodotto, a meno che non siano sotto sorveglianza o non siano state istruite a fondo sull'uso dell'apparecchio.
4. Prima della ricerca dei guasti, fermare le gambe della scrivania.
 - Spegnerne l'alimentazione e scollegare la spina dalla rete elettrica.
 - Rimuovere dal piano della scrivania tutto ciò che potrebbe appesantirlo.
5. Prima dell'avvio:
 - Assicurarsi che l'alimentazione sia compresa tra 100 e 240 V prima di collegare la scatola da incasso.
 - I singoli componenti devono essere collegati prima che la scatola da incasso sia collegata all'alimentazione principale.
6. Durante il funzionamento:
 - Se la scatola di controllo emette rumori o odori insoliti, spegnere immediatamente l'alimentazione principale.
 - Assicurarsi che i cavi non vengano danneggiati.
 - Scollegare il cavo di alimentazione principale dell'apparecchio mobile prima di spostarlo.

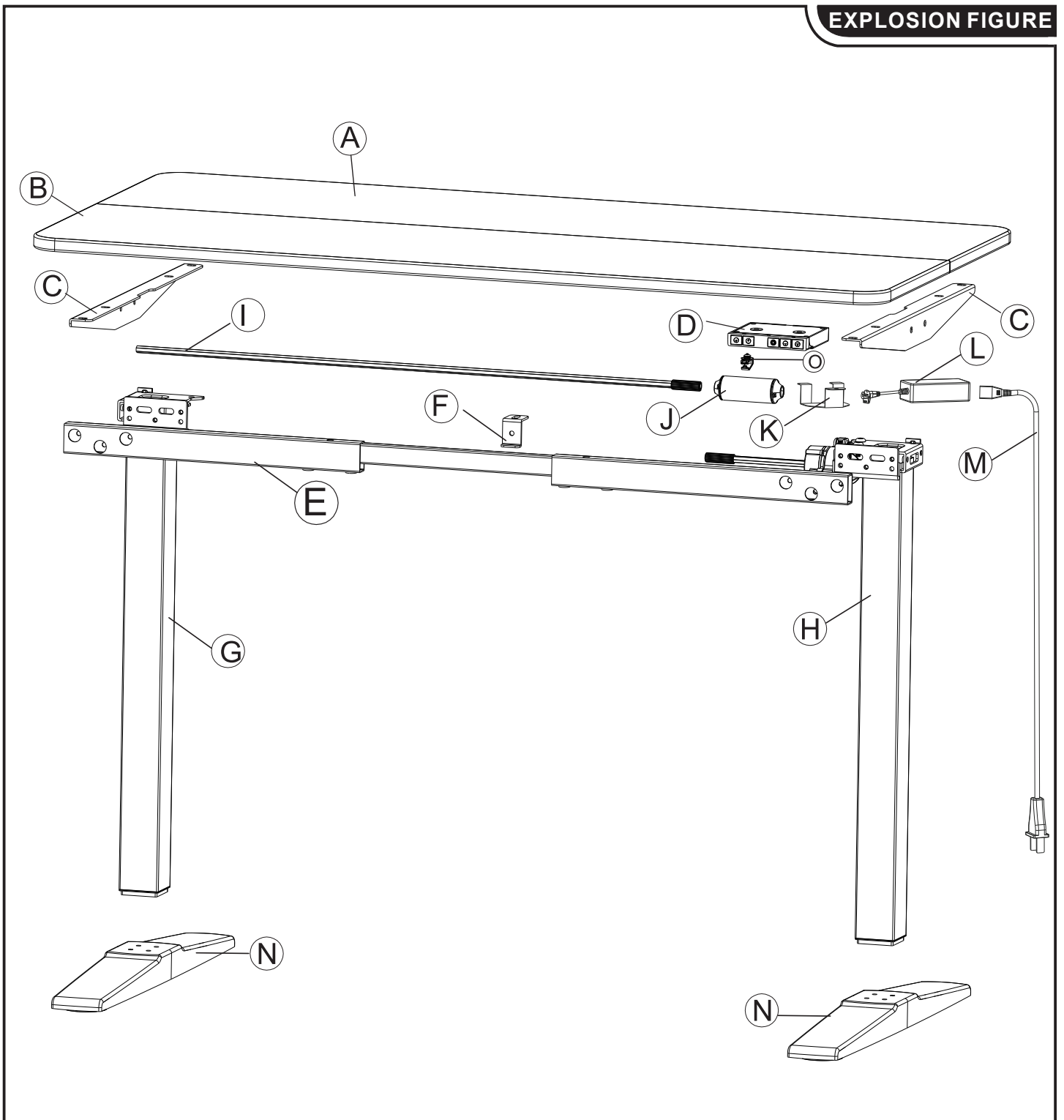

Input voltage	100-240	V
Input AC frequency	50/60	Hz
Output voltage	DC29	V
Output current	1.8	A
Output power	52.2	W
Average active efficiency	30	%
Efficiency at low load (10 %)	20	%
No-load power consumption	0.5	W

A x1

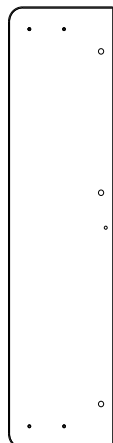

B x1

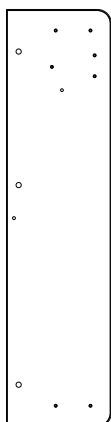

C x2



D x1

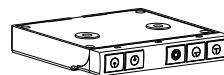

E x1



F x1

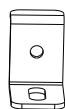

G x1



H x1

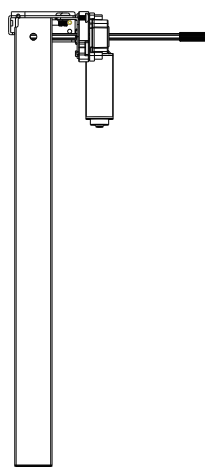

I x1



J x1



K x1

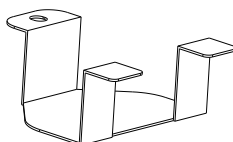

L x1

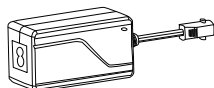

M x1

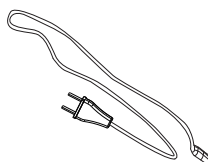

N x2



O x1

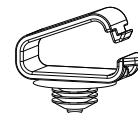

P x5



Q x3

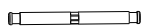

R x6



S x33

+2 (spare)



T x1



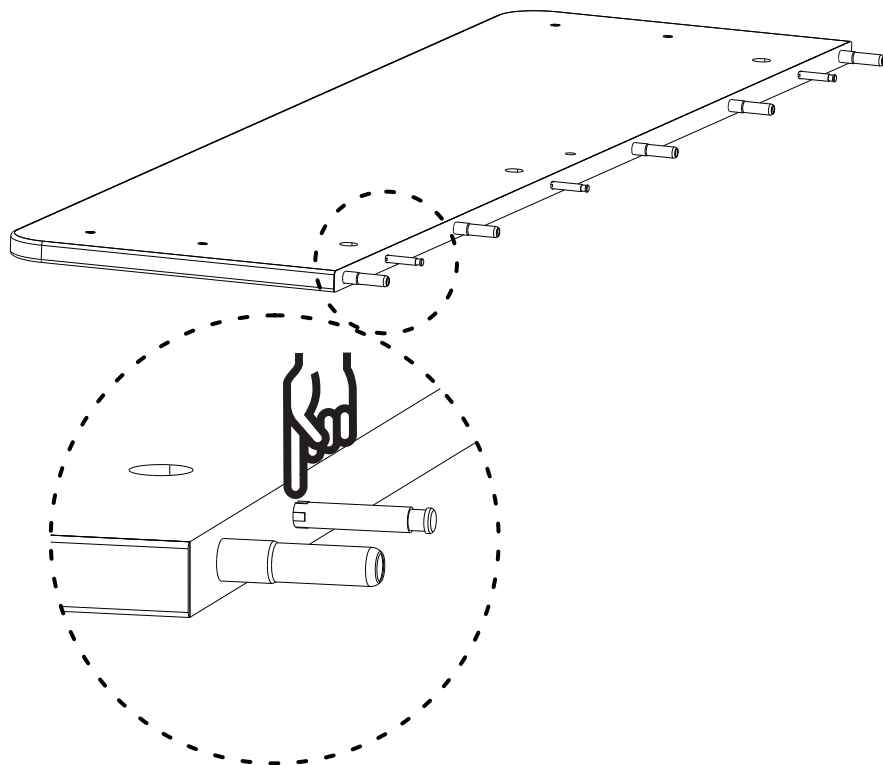
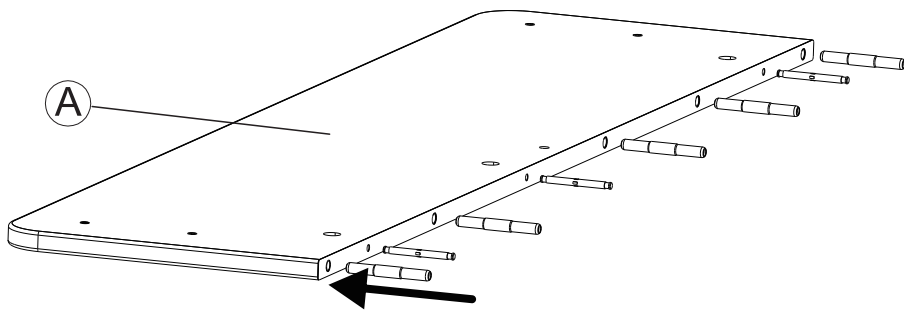
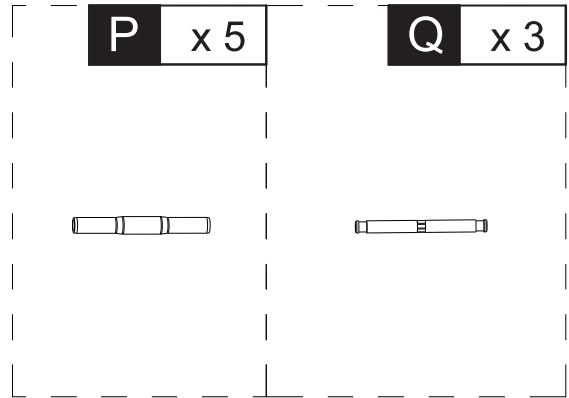

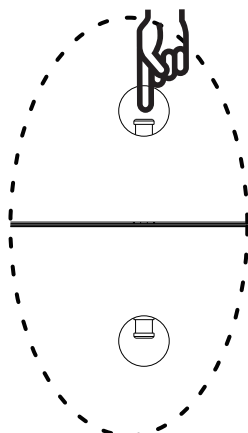
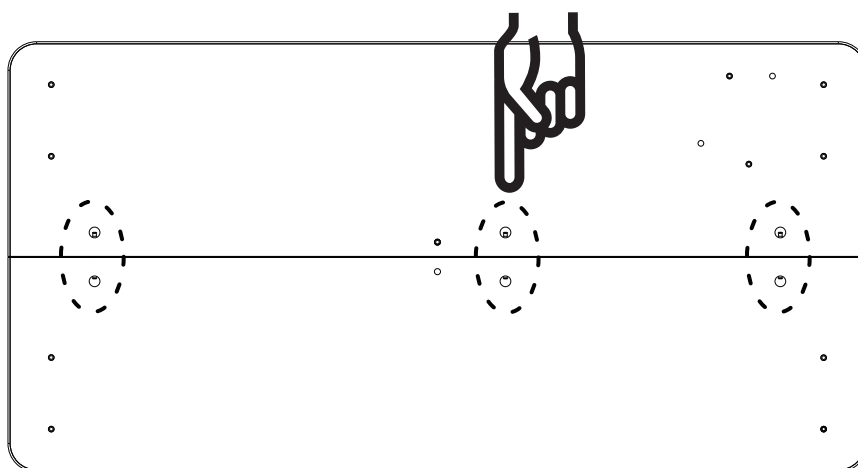
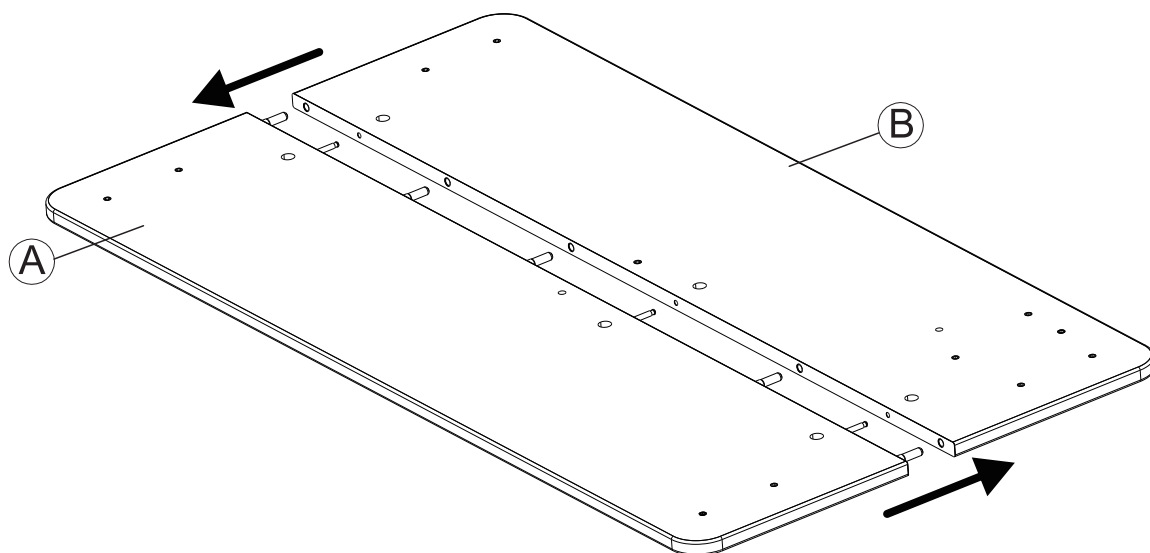

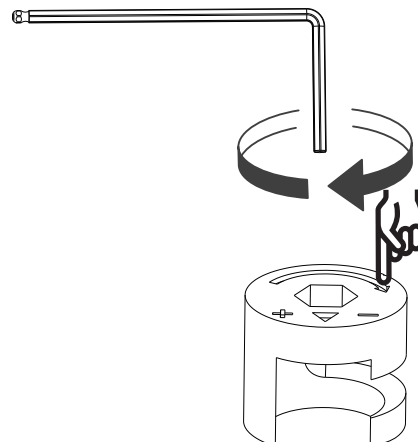
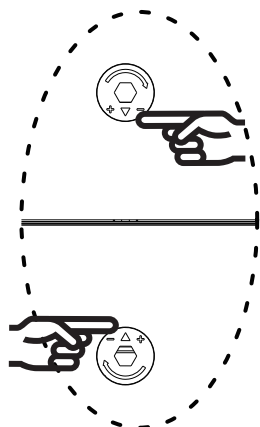
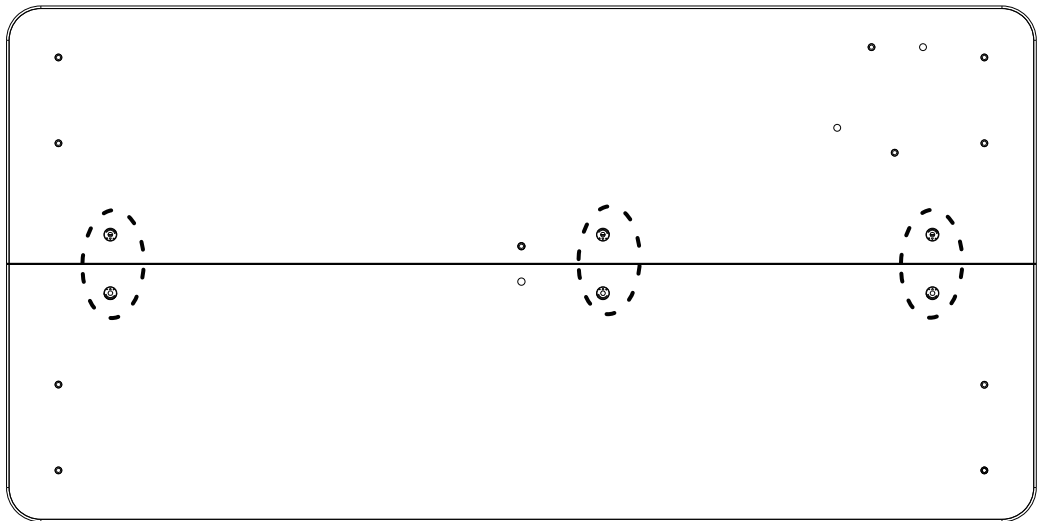
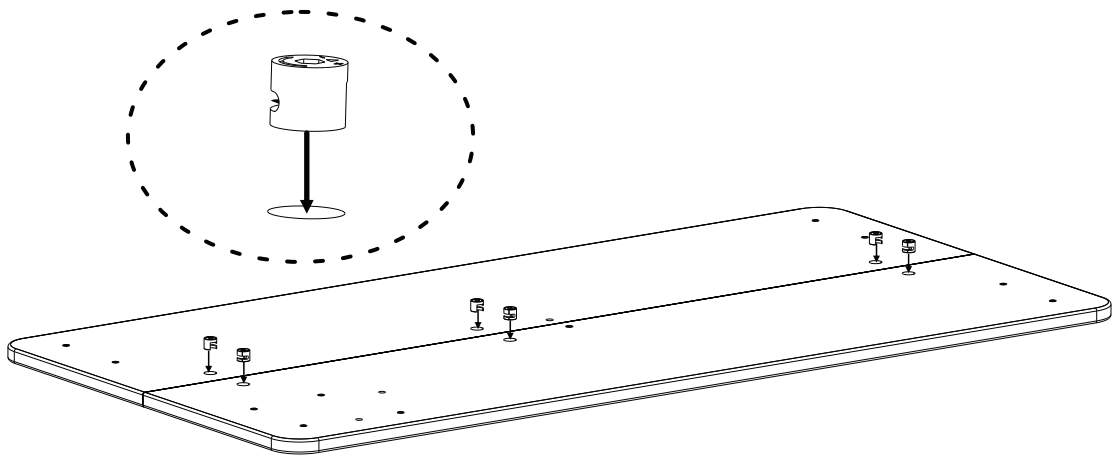
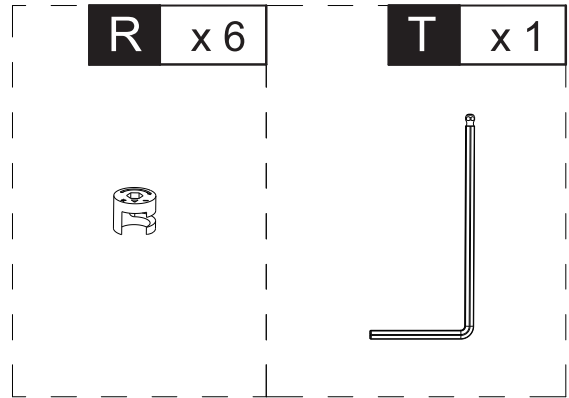

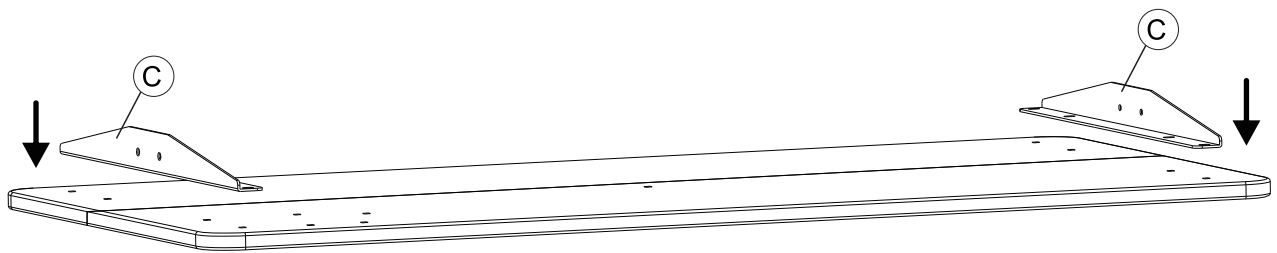
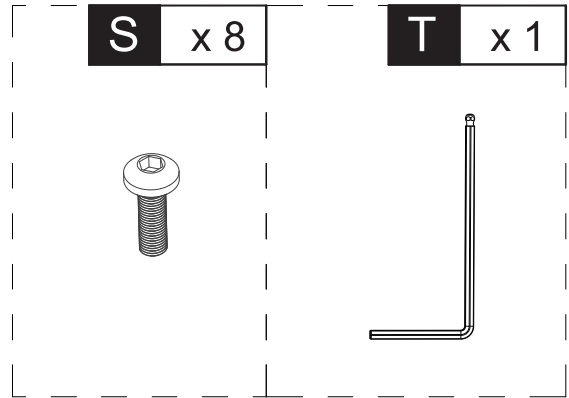

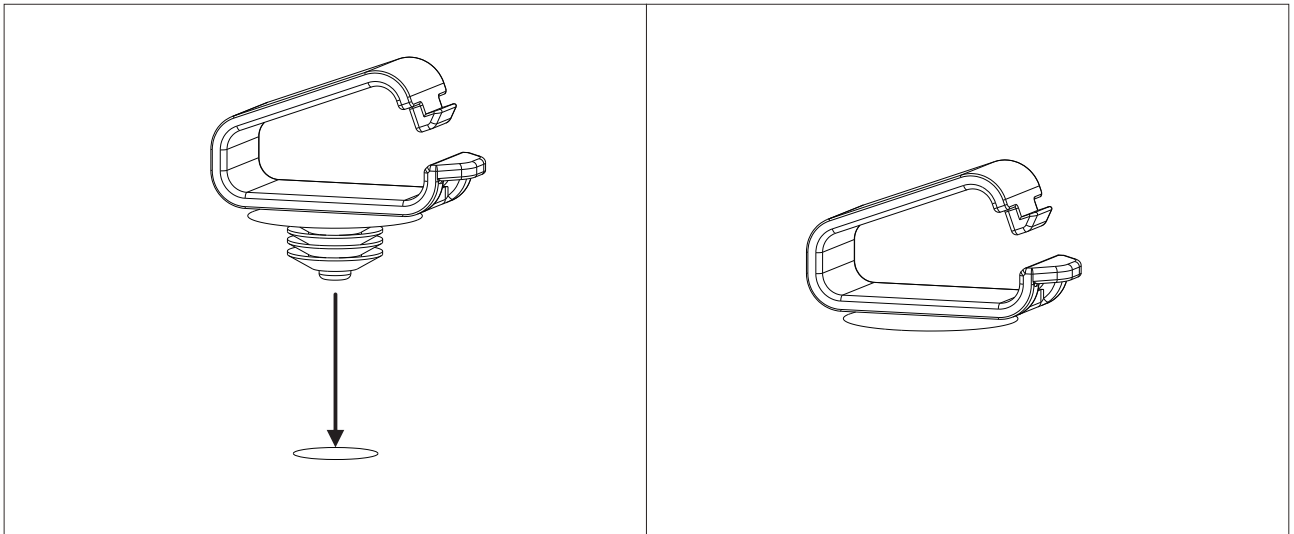
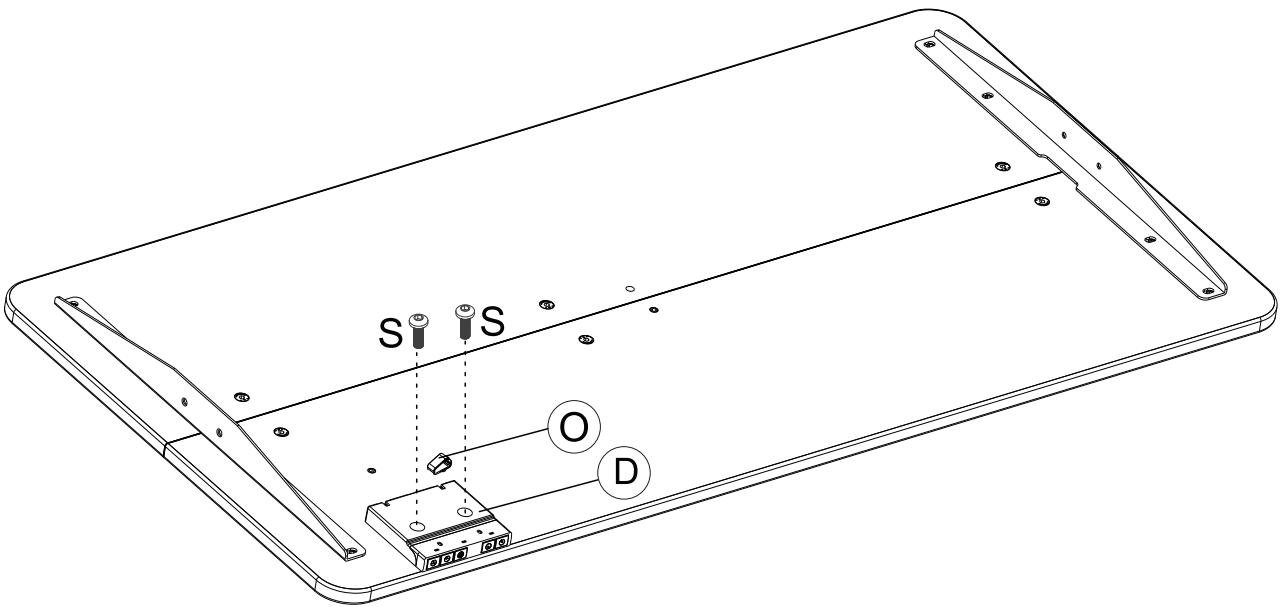
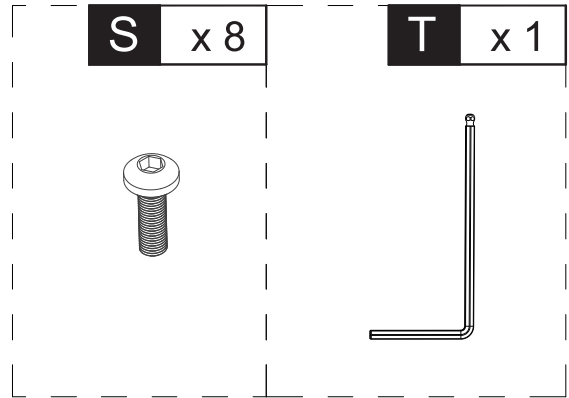

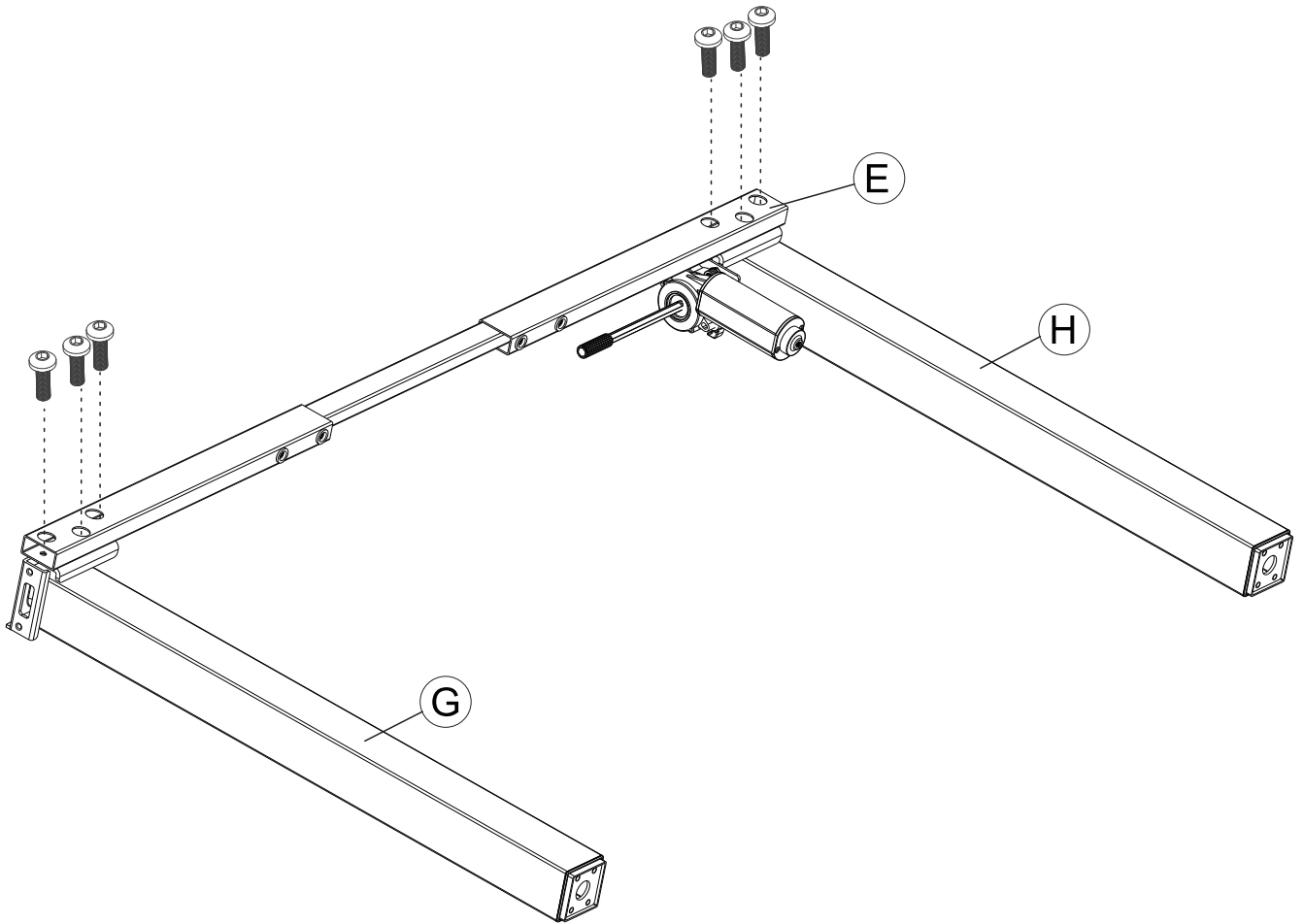
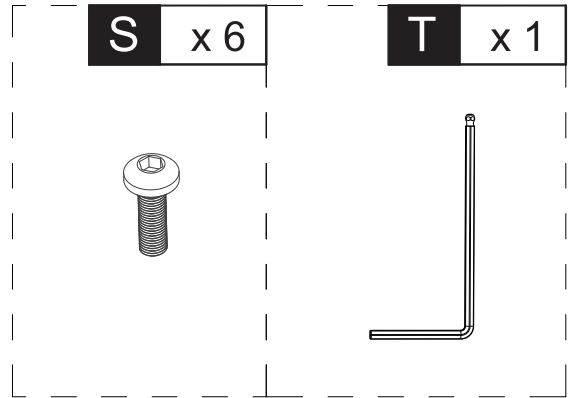

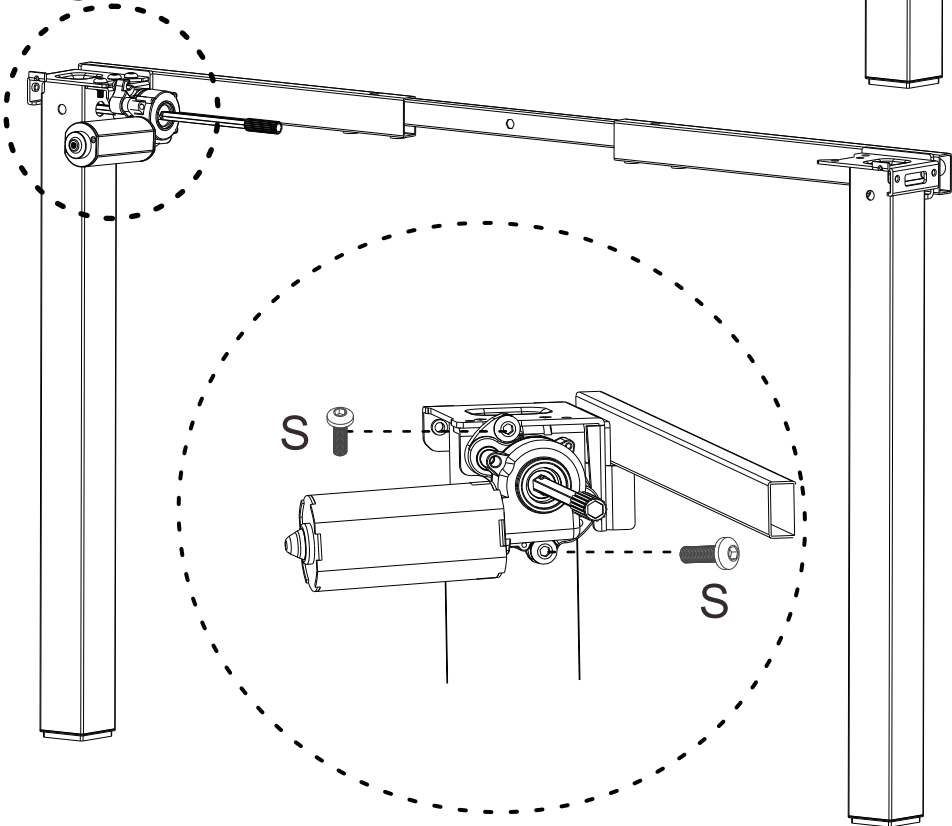
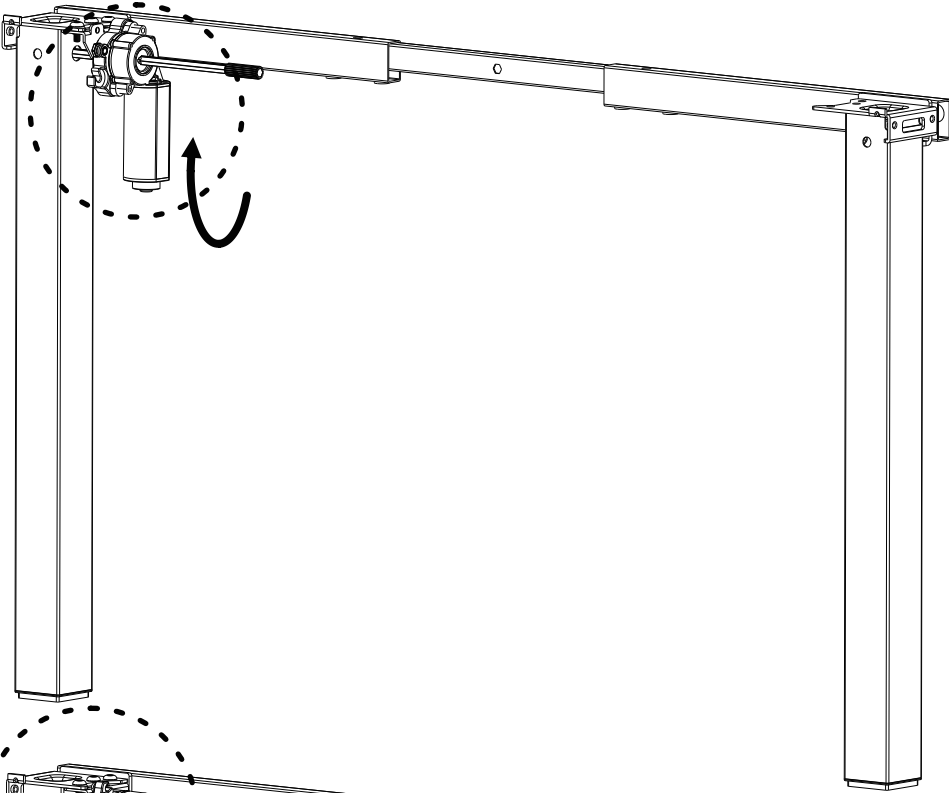
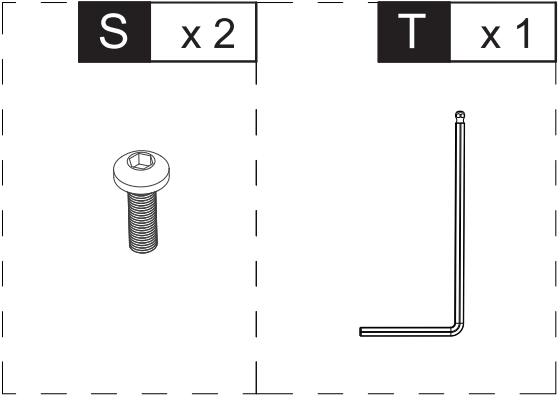

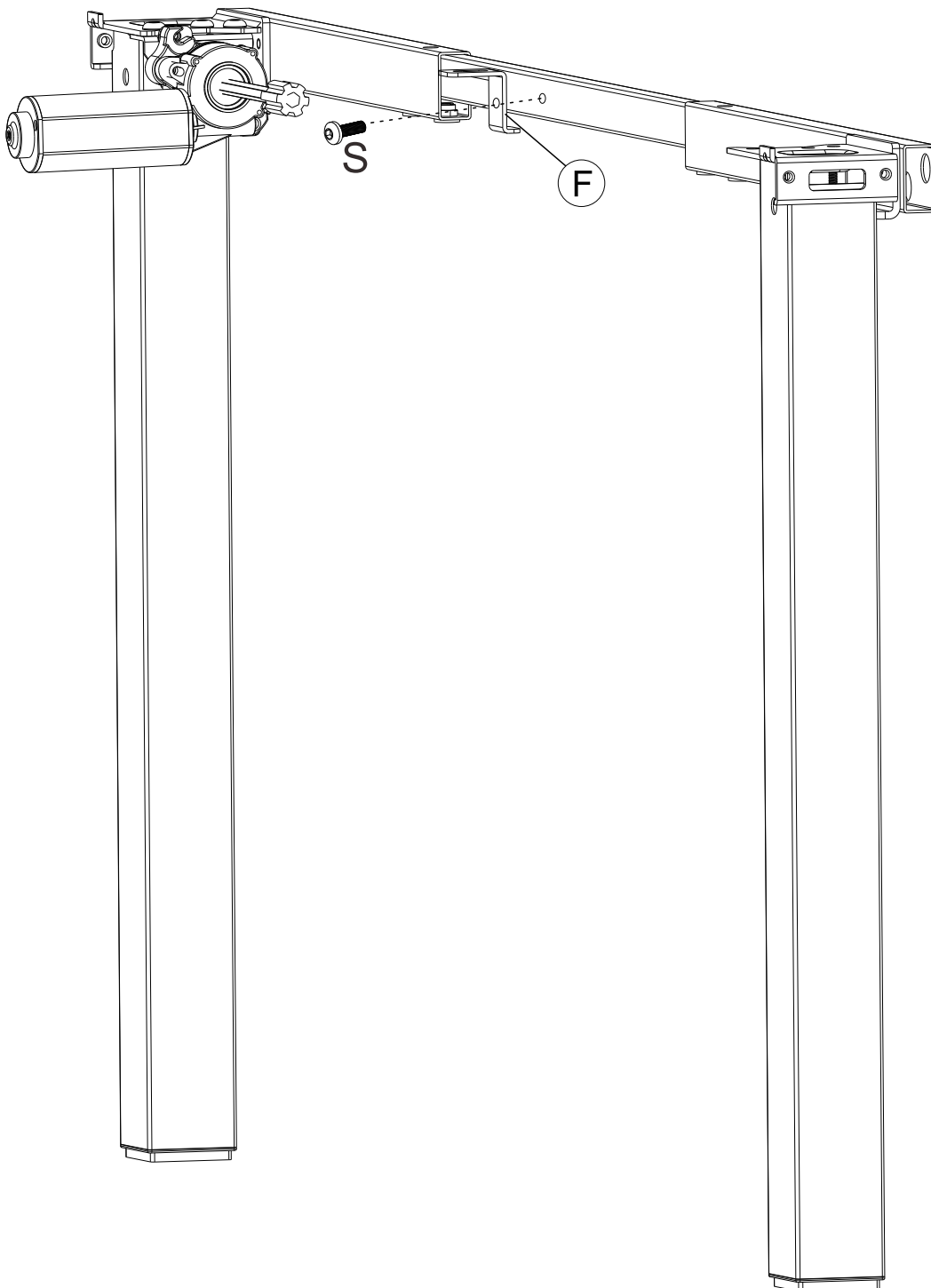
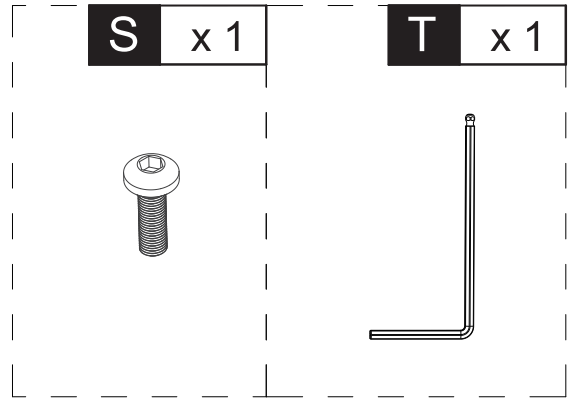

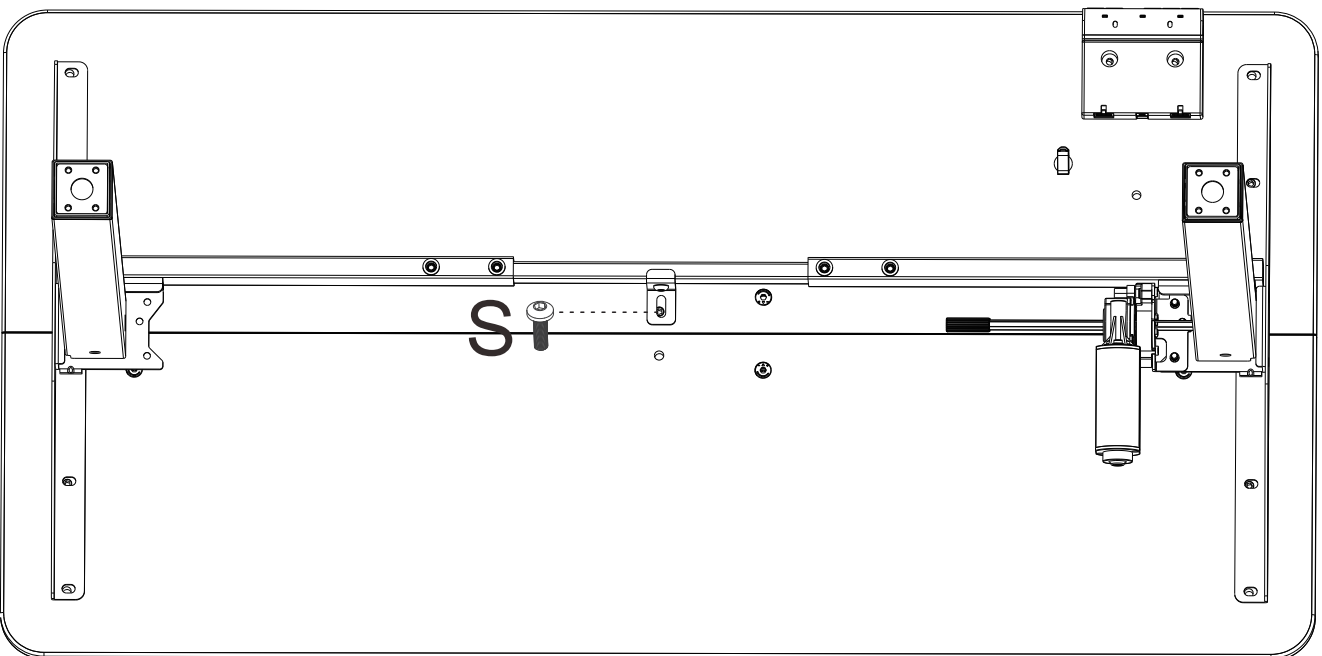
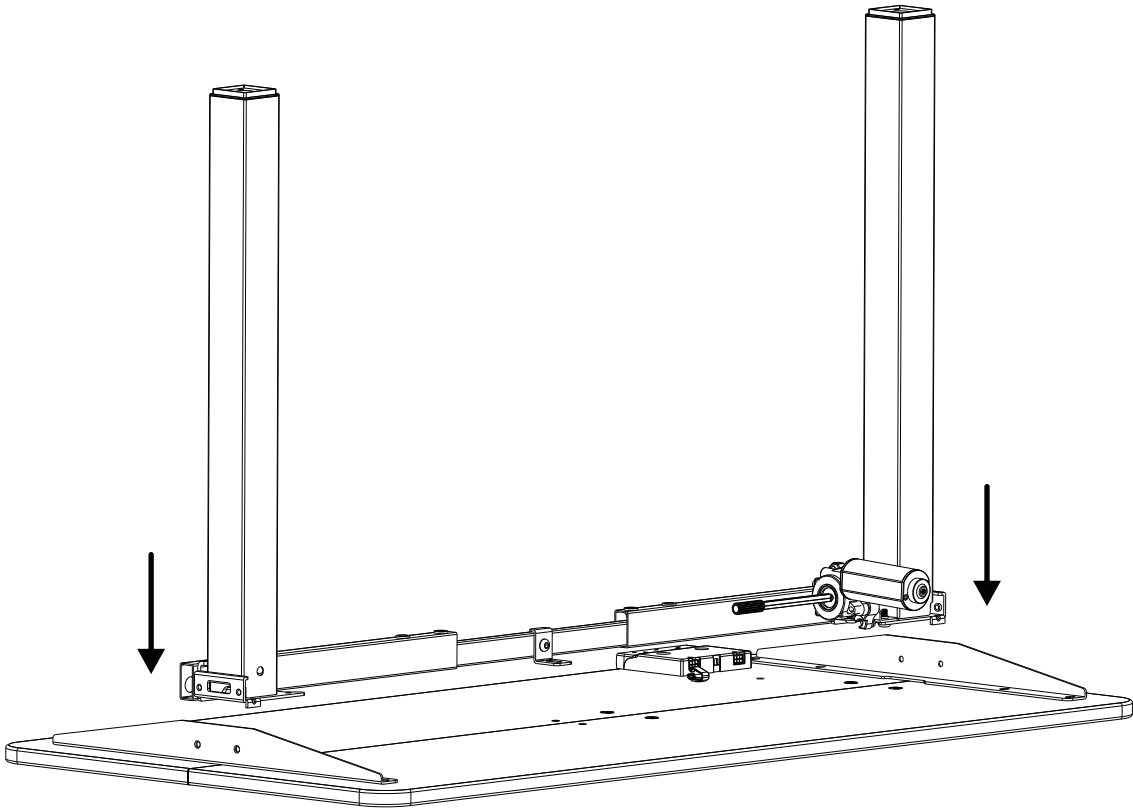
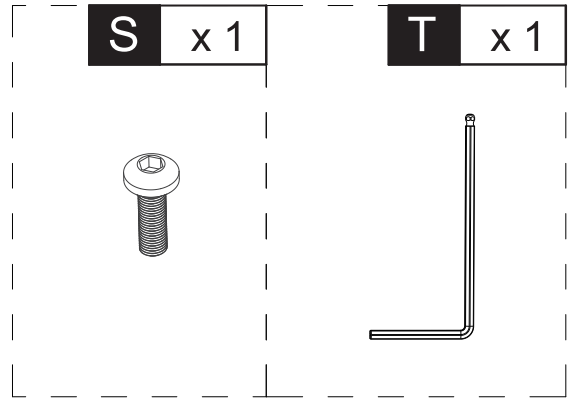

S x 4

T x 1

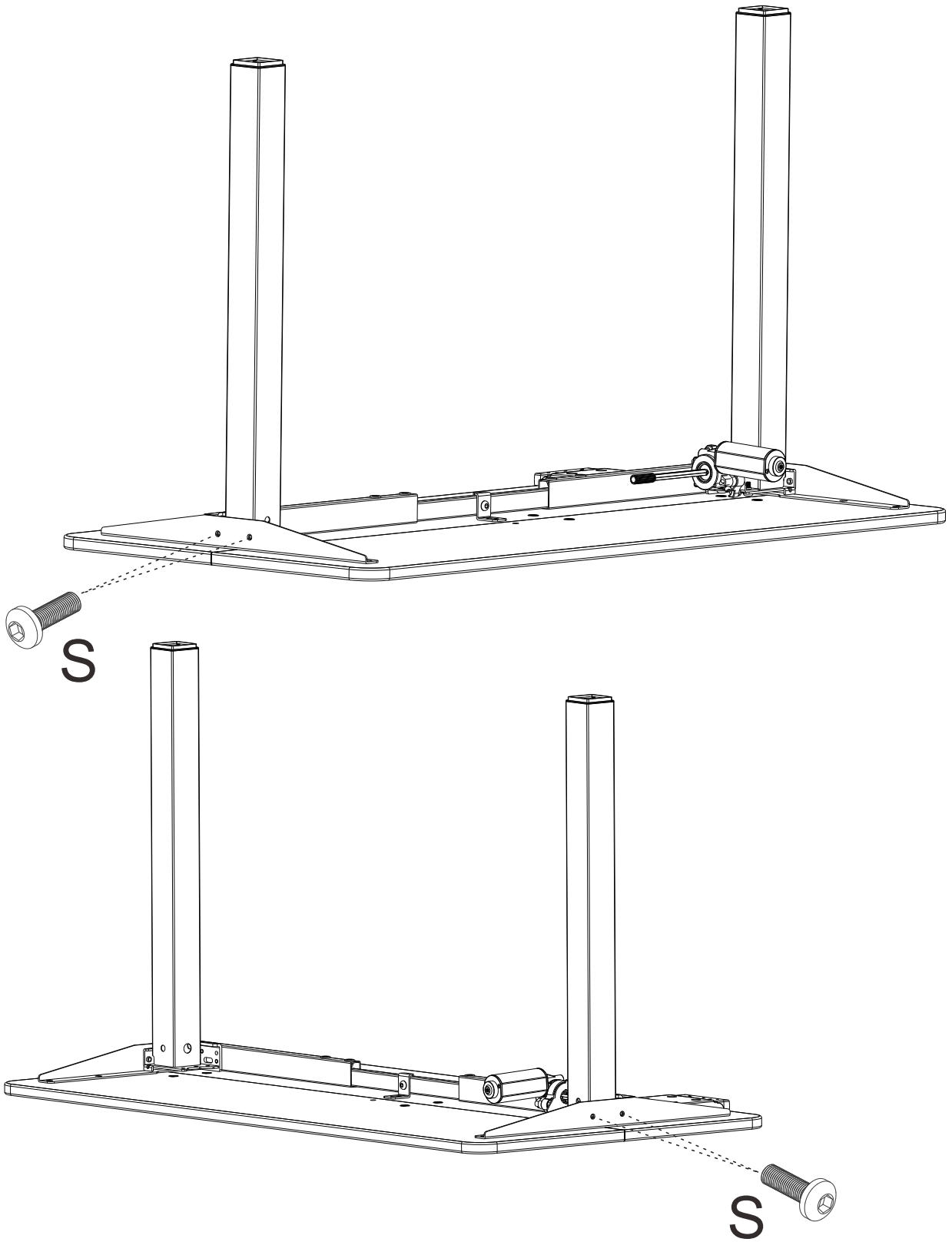
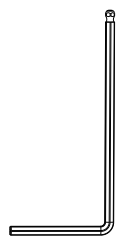
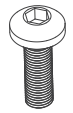

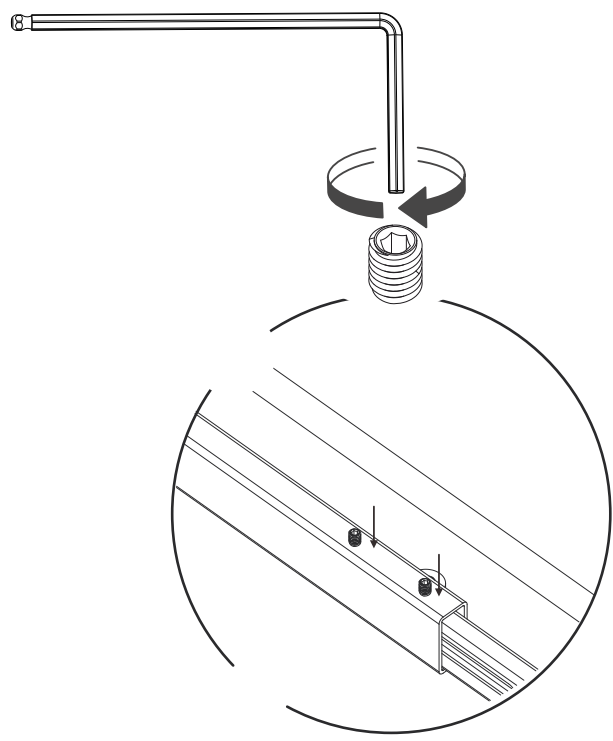
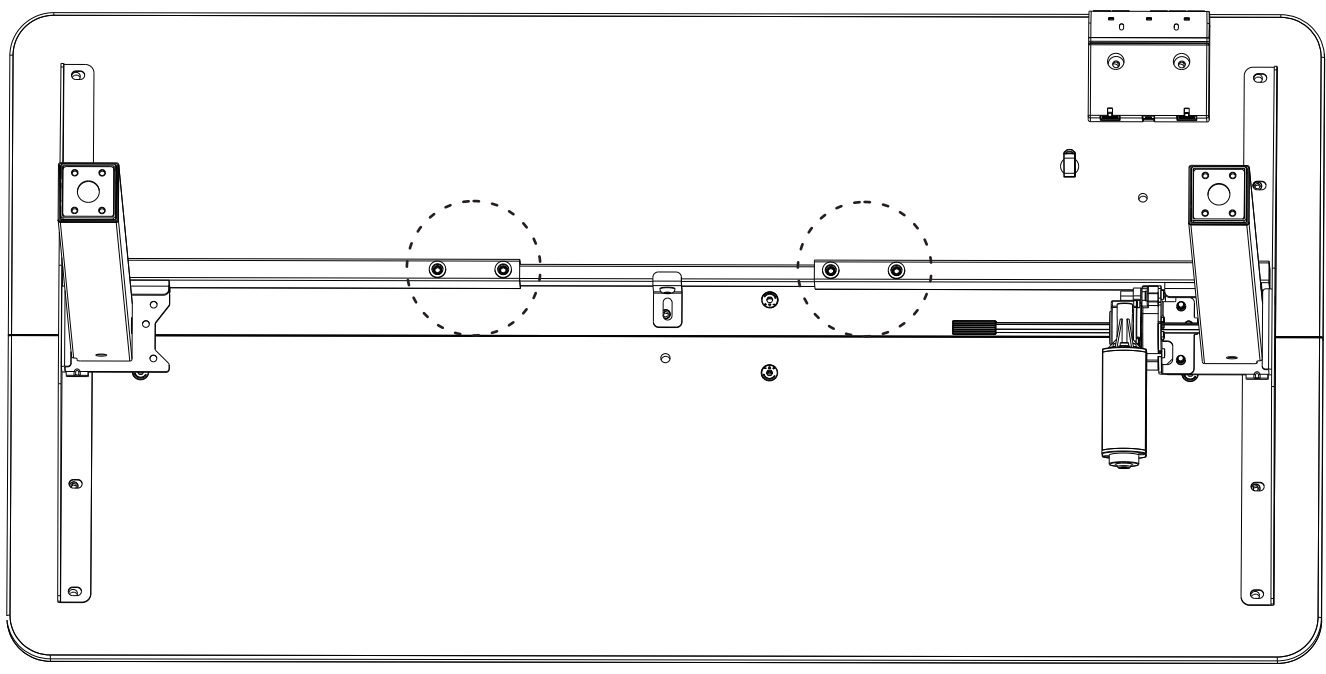
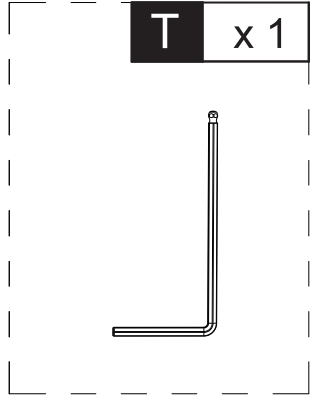

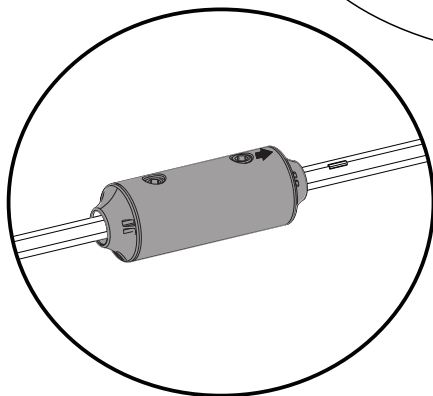
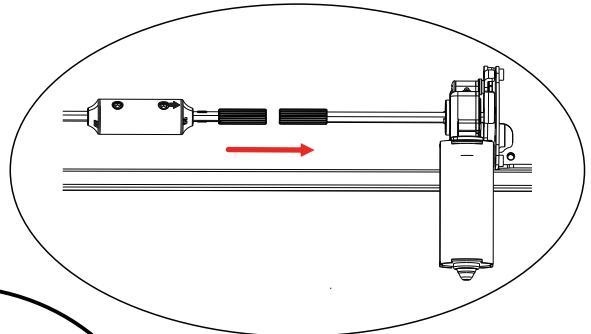
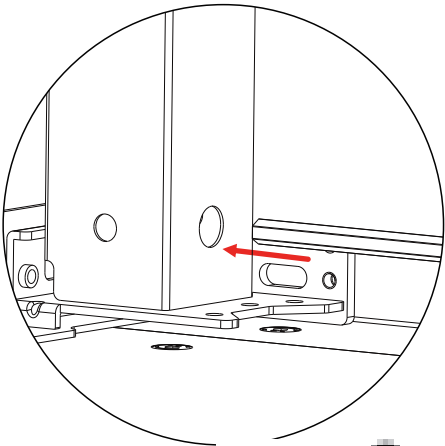
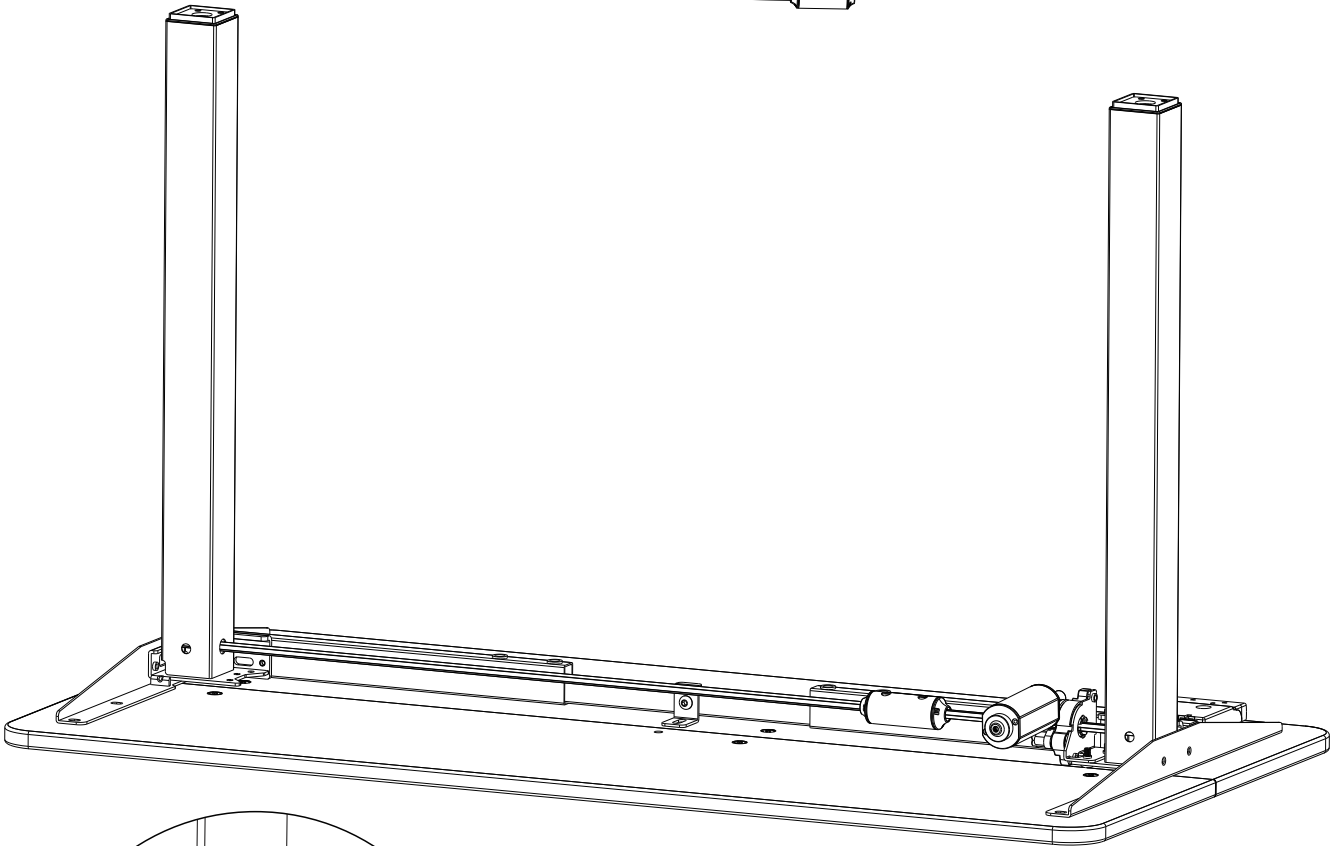
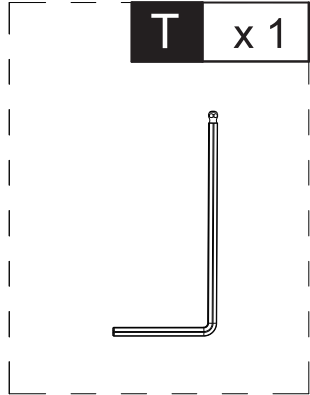
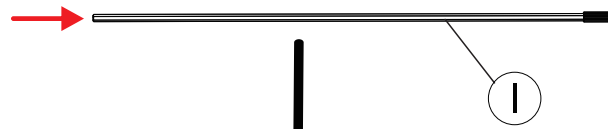
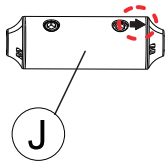
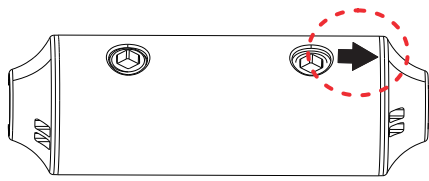

T x 1

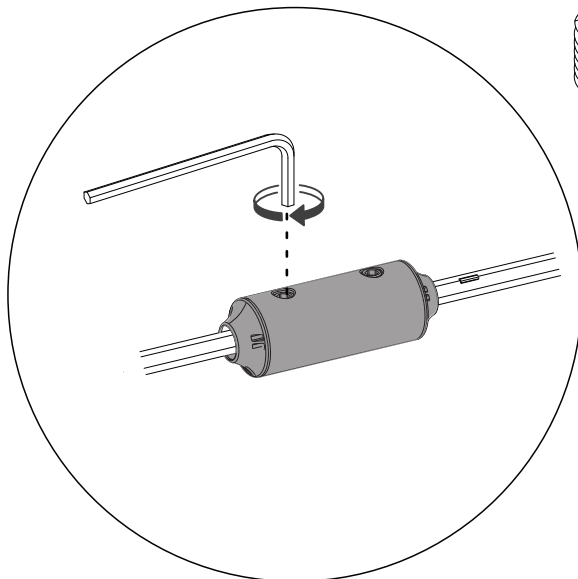
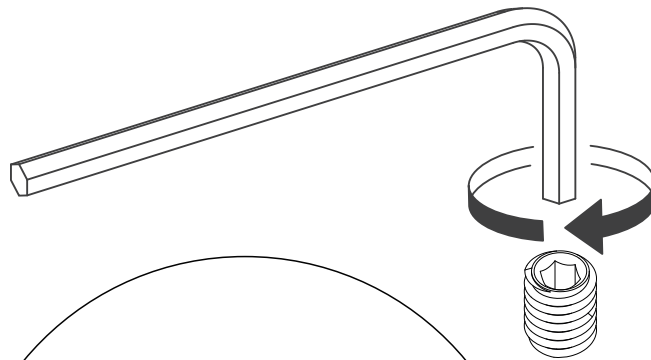
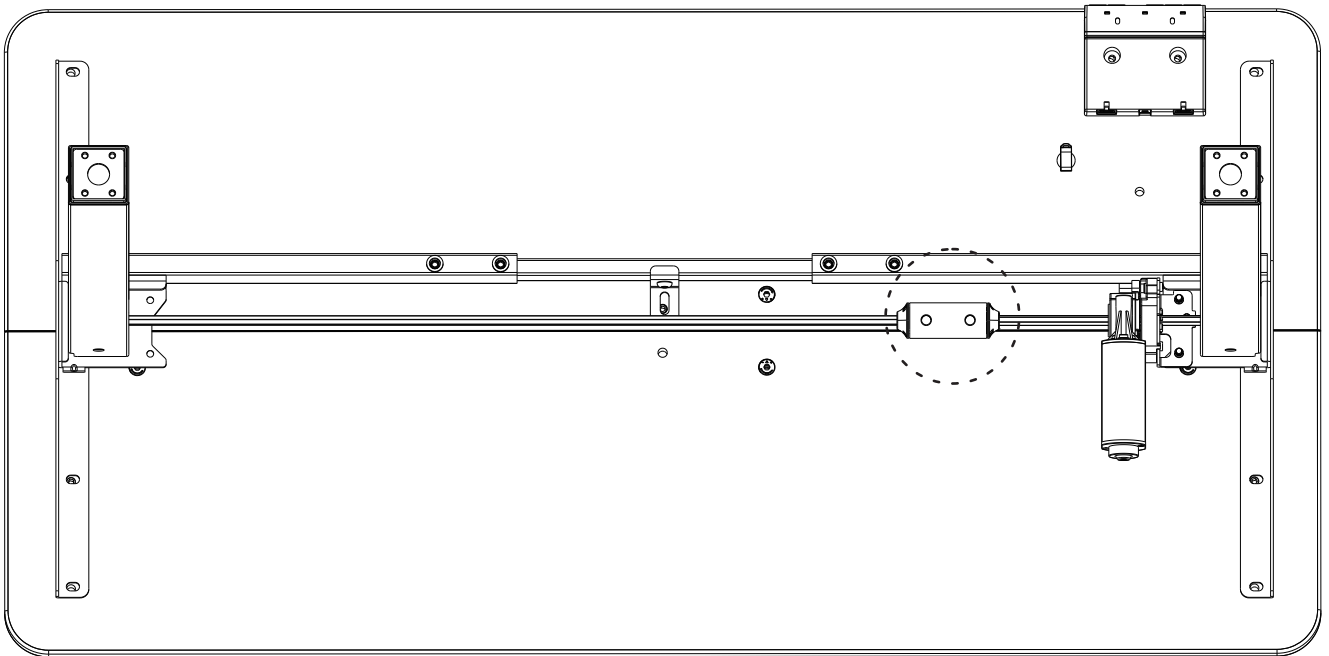
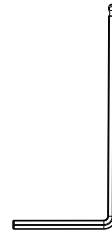

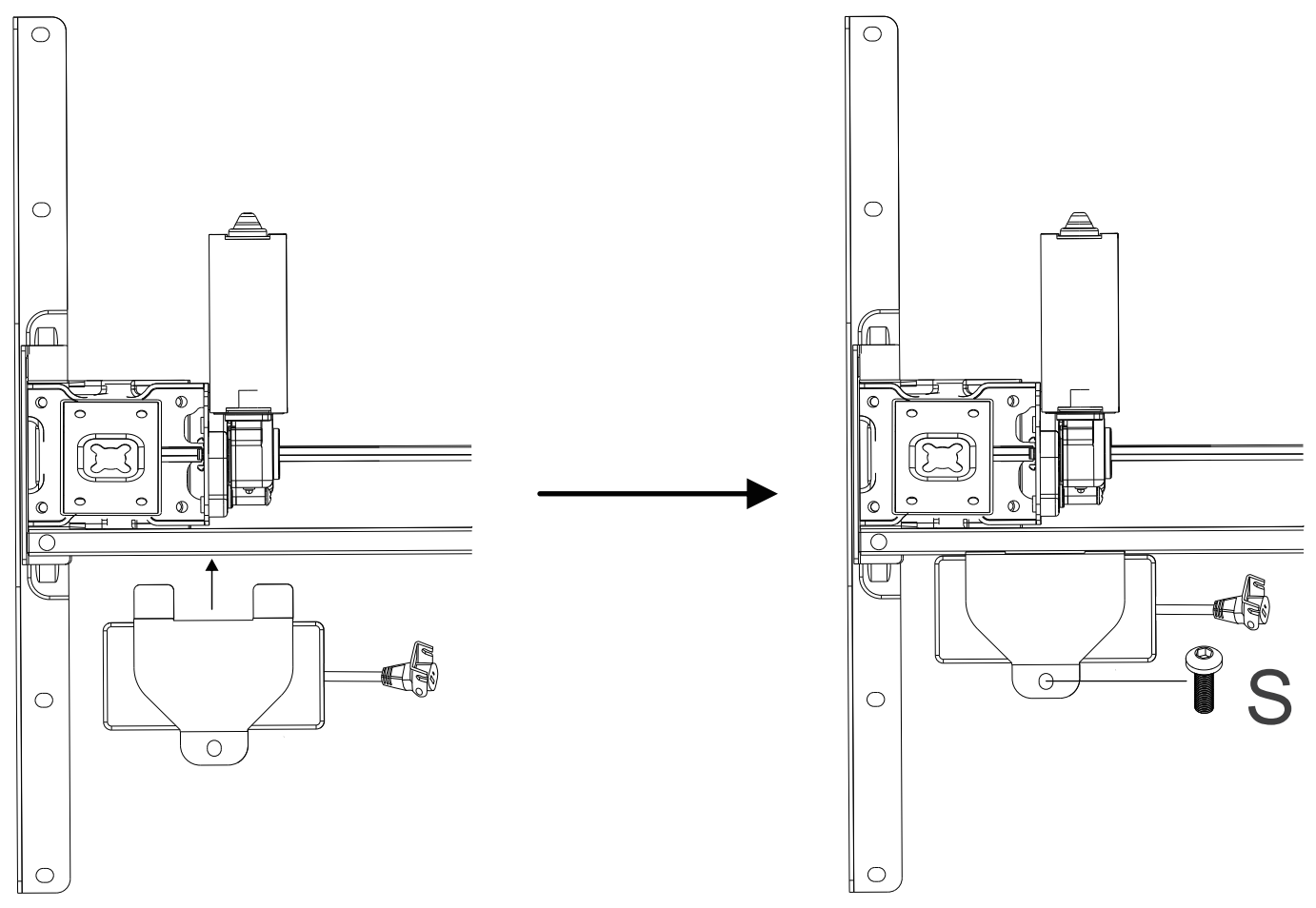
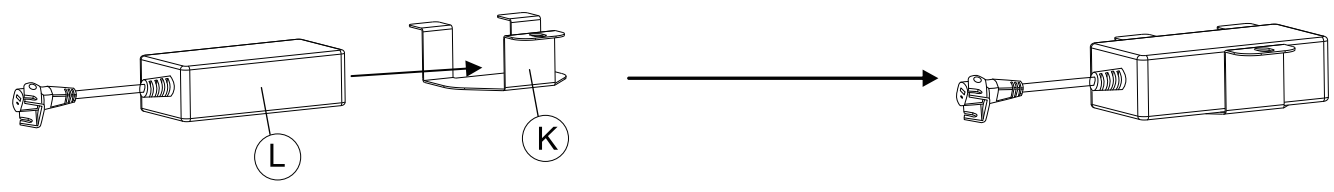
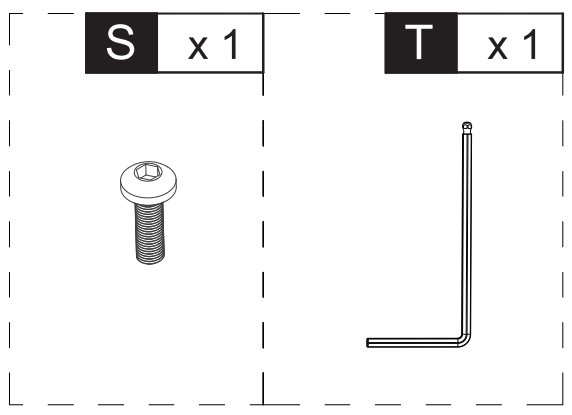

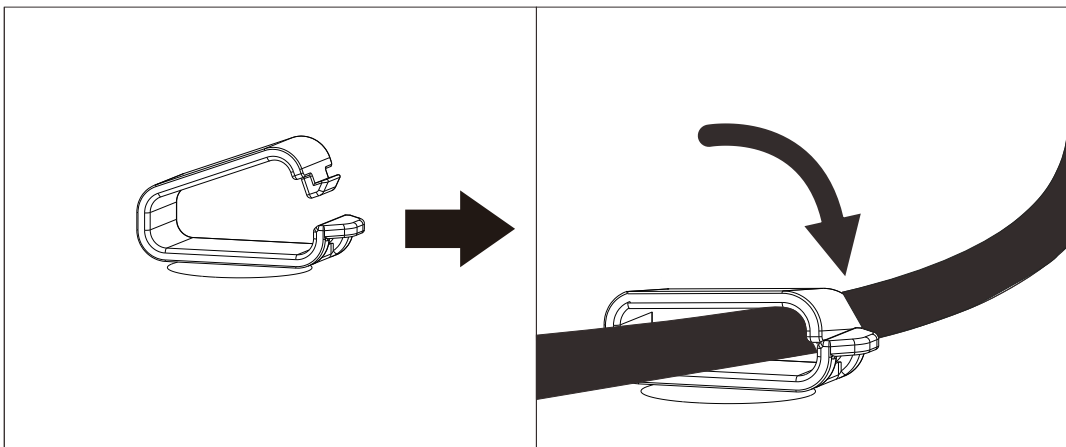
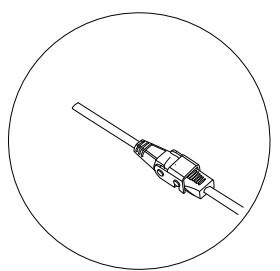
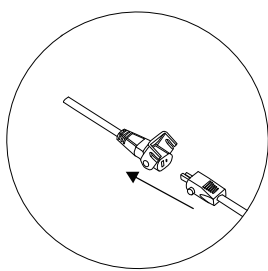
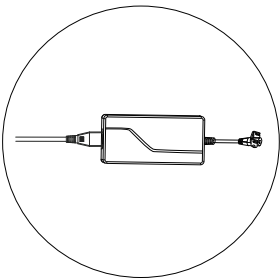
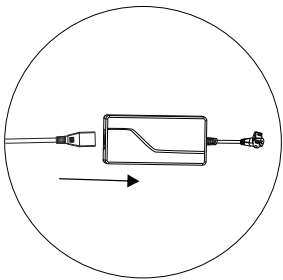
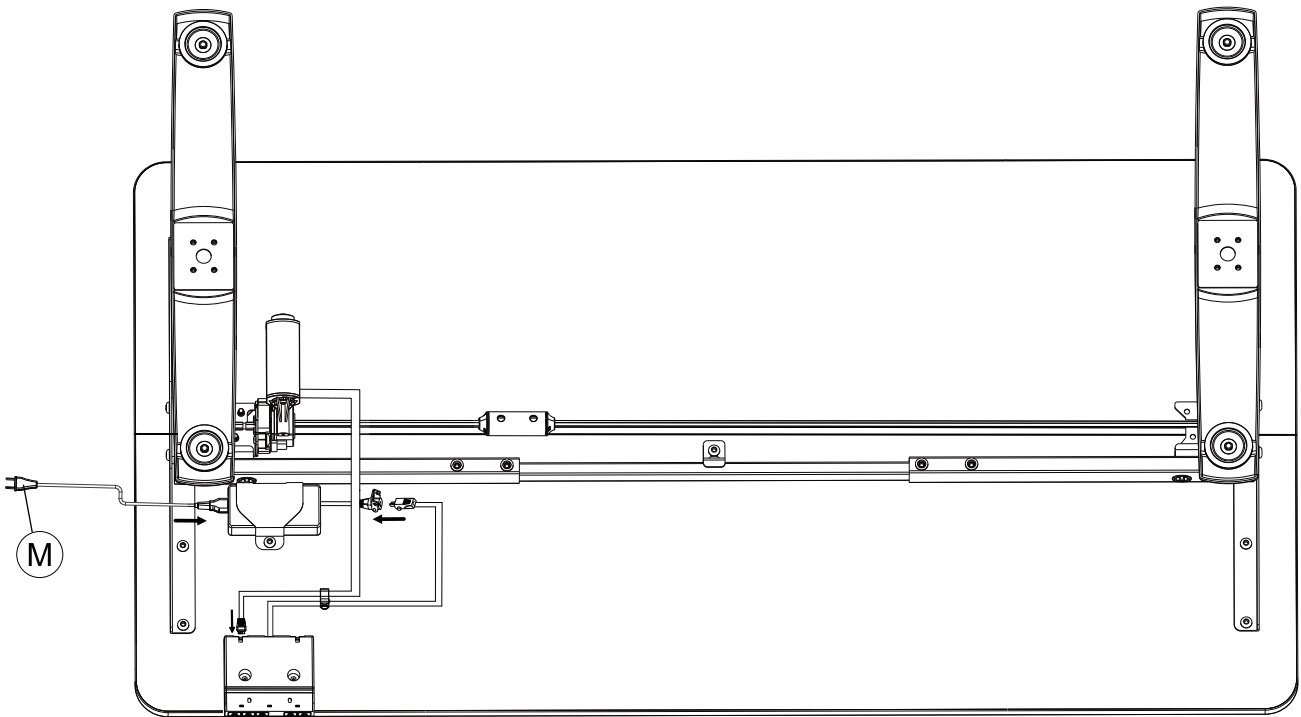

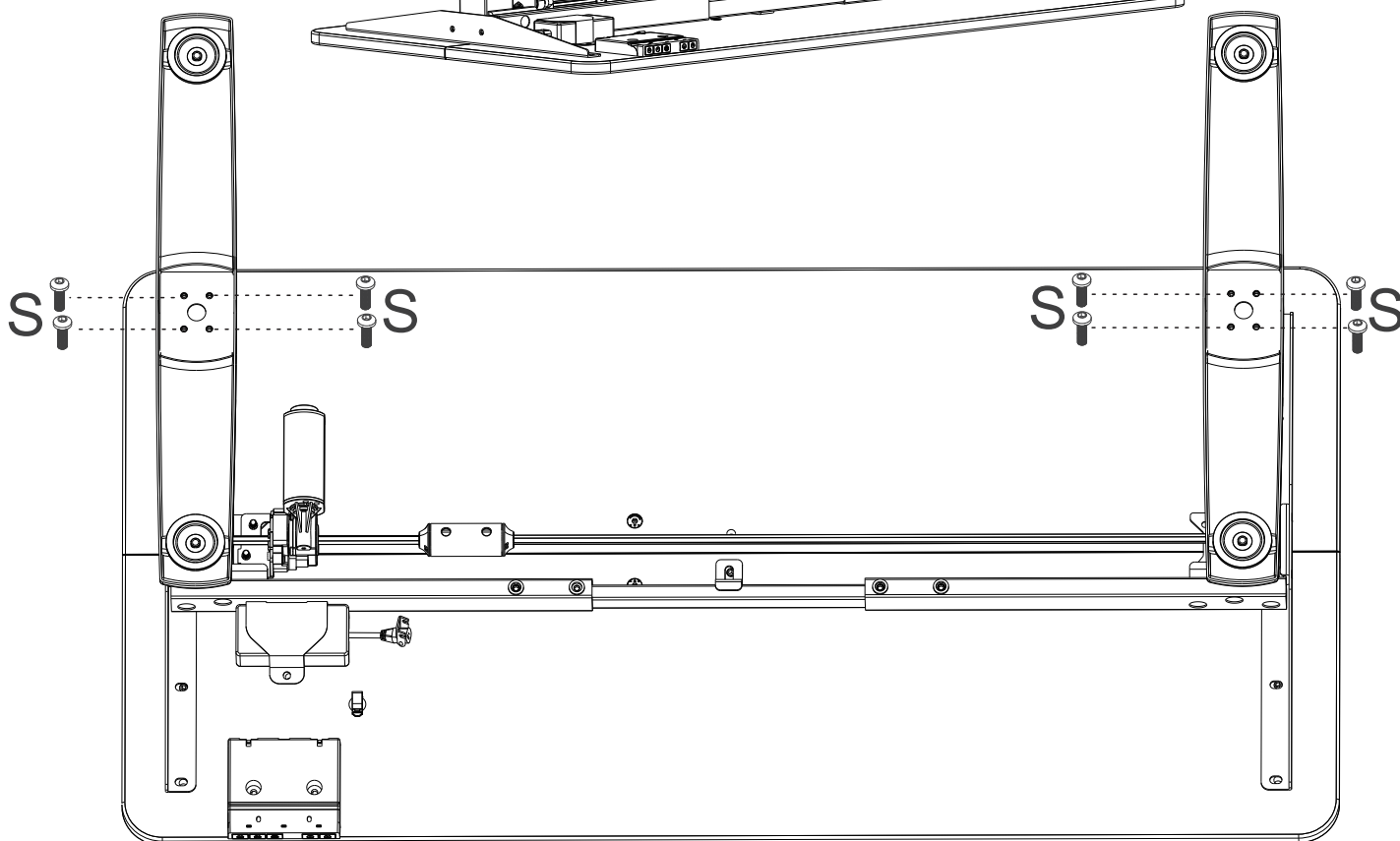
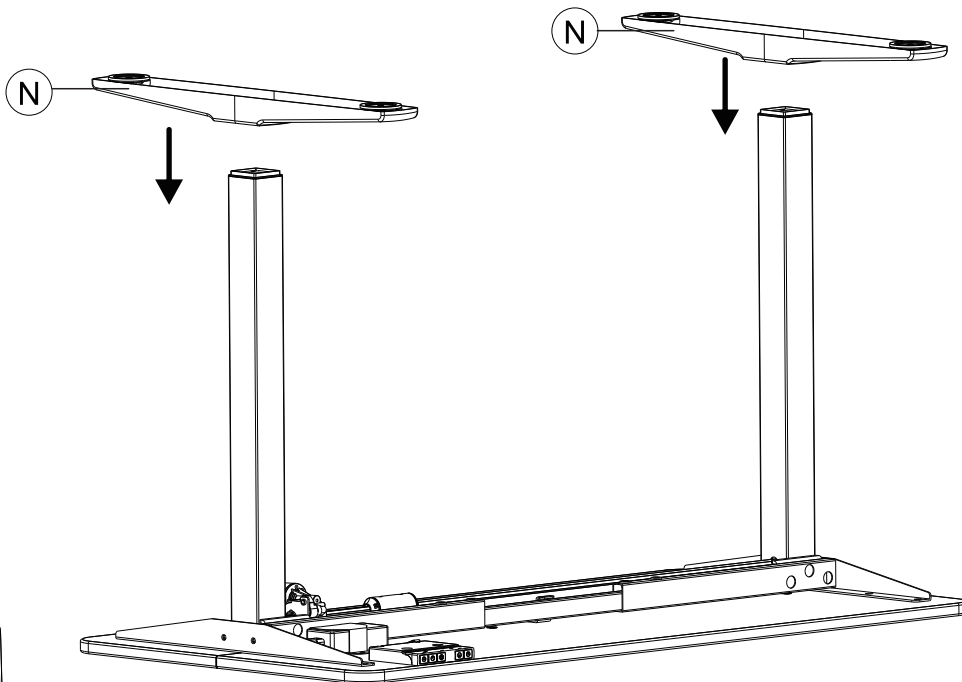
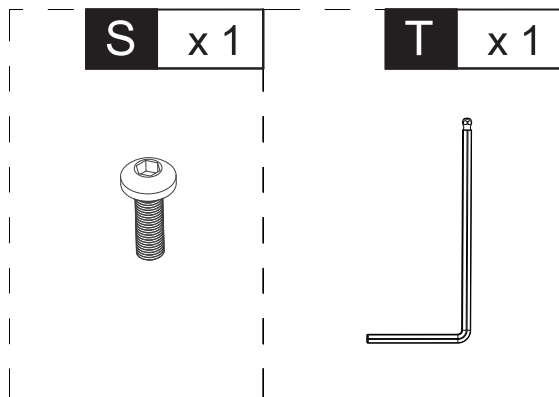

User Guide

IMPORTANT: You must reset the desk prior the use.

Make sure no obstacles are in the desk's path.

Make sure the desktop is not touching any walls.

Make sure all cords are appropriate length to accommodate the change in height.

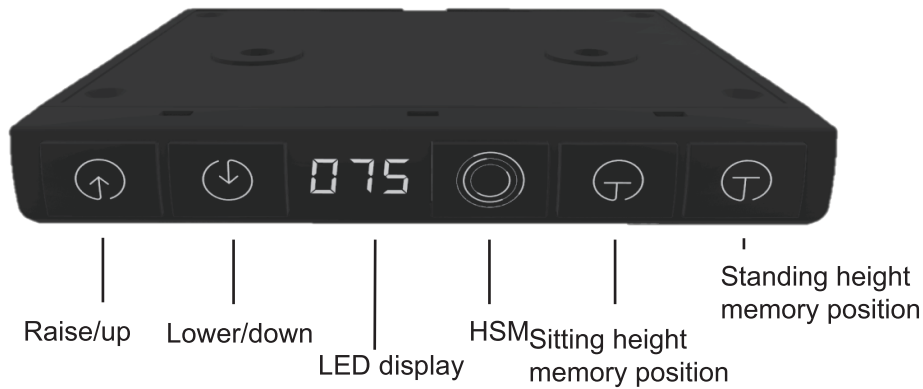

Notice

While raising or lowering the table, please make sure objects are secure on the table, and nothing prevents the table from raising or lowering through its desired range of adjustment.

Suggestion

Please set the preferred table height while sitting by pushing the "sitting position memory key", and the preferred table height while standing by pushing "the standing height memory key".

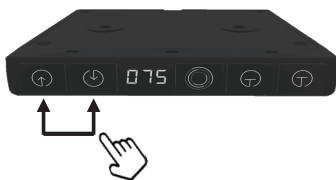



Table Height Adjustment

Press up  or down  to raise or lower the table to the preferred table height.



Memory Presets

At the preferred lower table height for seated work, press the left  for 3+ seconds to set memory.

At the preferred higher table height for standing work, press the right  for 3+ seconds to set memory.

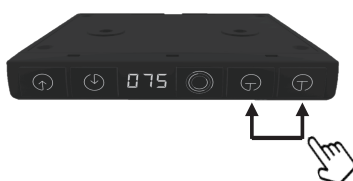

Use of Memory Keys

Briefly press the key left  and release, the table will move to the preferred seated work height.

Briefly press the key right  and release, the table will move to the preferred standing work height.

 Table adjustment stops by pressing any key on the control pad

HSM mode

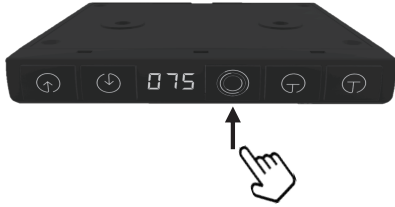

When the light is flashing, the table will slowly move up 12 cm in 3 minutes, will stop for 2 minutes, and then will slowly move down by 12 cm in 3 minutes. After 2 minutes the movements will repeat.

Power ON/OFF

1. Press the  key to turn the operating system ON; the backlight light will be on;
 2. The system automatically shuts OFF after 4 hours.
- * If operating other keys, the backlight is off .







Reset control pad



In the lowest position or when prompted by the "protection and alarm" message, press the down arrow  for 3+ seconds, the table moves all the way down and will raise to a preset height at which time the reset is completed.

Notice: Objects under the table should be removed before the reset operation to prevent damage to table or other items.

Protection and Alarm

-  Anti -interference : message/alarm "E02" appears when the desktop vibrates, is interfered with, or tilts during an adjustment. Stop adjustment immediately and reverse movement; after a certain adjustment the alarm will disappear.
-  Overheating protection : message/alarm "Hot" appears when continuous adjustment time exceeds 2 minutes, the overheating protection will be triggered. Stop adjustment immediately; wait for 18 minutes after which the alarm will disappear.
-  Motor malfunction protection : message/alarm "E10" appears. Power should be disconnected, re-check and ensure that the motor connected to the controller is secure, connect to power source.
-  Overload protection : message/alarm "E20" appears when the table is raised while overloaded. Remove weight, heavy objects from the table before adjustments. If overload occurs when lowering the table, please press the  for 3+ seconds to reset.
-  Out of Sync protection : message/alarm "E60" appears (multi -motor systems only!). Power should be disconnected, re-check and ensure that the motor connected to the controller is secure, connect to power source for reset.

Guide Utilisateur

IMPORTANT : Vous devez réinitialiser le pupitre avant de l'utiliser.

Assurez-vous qu'aucun obstacle ne se trouve sur la trajectoire du bureau.

S'assurer que le bureau ne heurte aucun mur.

S'assurer que tous les cordons sont d'une longueur appropriée pour s'adapter au changement de hauteur.

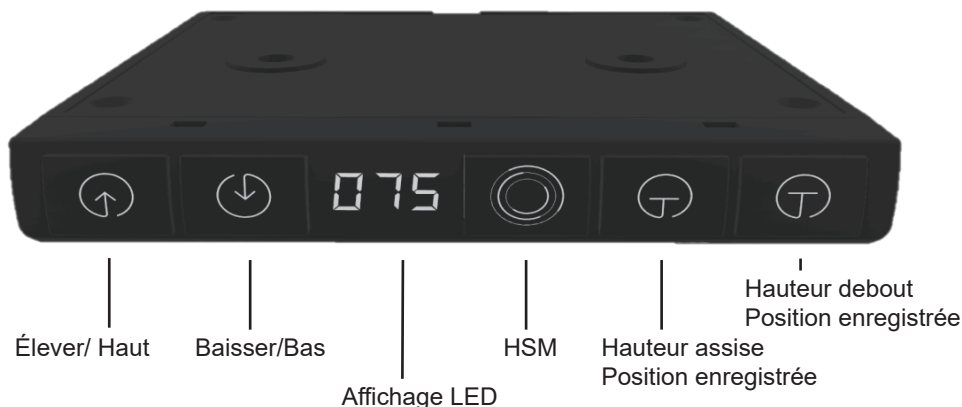

Avis



Pendant que vous levez ou abaissez le bureau, assurez-vous que les objets sont bien fixés sur le bureau et qu'il n'y a rien qui empêche le bureau de monter ou de descendre dans sa plage de réglage souhaitée.

Suggestion

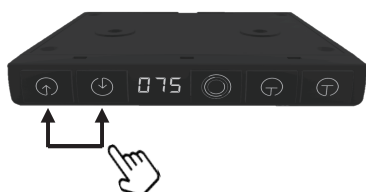
Réglez la hauteur préférée de la table en position assise en appuyant sur le bouton "mémorisation hauteur assise", et la hauteur souhaitée de la table en position debout en appuyant sur le bouton "mémorisation hauteur debout".



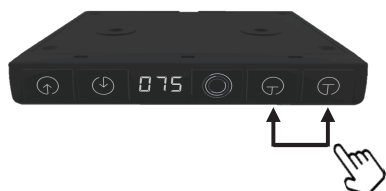

Réglage de la hauteur de la table

Appuyez sur Haut  ou Bas  pour lever ou abaisser la table à la hauteur de table souhaitée.





Appuyer 3+ secondes

Préréglages

A la hauteur souhaitée pour le travail assis, appuyez sur le bouton gauche  pendant plus de 3 secondes pour enregistrer la hauteur en mémoire . A la hauteur souhaitée pour le travail debout, appuyez sur le bouton droit  pendant plus de 3 secondes pour enregistrer la hauteur en mémoire.

Utilisation des touches Mémoire

Appuyez brièvement sur le bouton à gauche  et relâchez-la. La table se déplace à la hauteur de travail assise définie.

Appuyez brièvement sur le bouton à droite  et relâchez-la, la table se déplace à la hauteur de travail debout définie.



Le réglage de la table s'arrête en appuyant sur n'importe quelle touche de la console de commande.

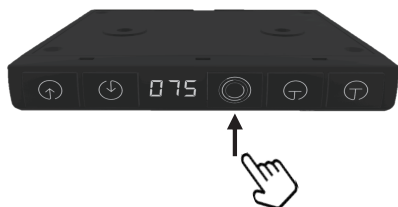

Mode HSM

Lorsque le voyant clignote, la table monte lentement de 12 cm en 3 minutes. Elle s'arrête ensuite pendant 2 minutes, puis redescend lentement de 12 cm en 3 minutes. Après 2 minutes, les mouvements se répètent.

Alimentation ON/OFF

1. Appuyer sur  pour mettre le système d'exploitation en marche ; le rétroéclairage s'allume ;
2. Le système s'éteint automatiquement après 4 heures.

*Si vous actionnez d'autres touches, le rétro-éclairage est éteint.



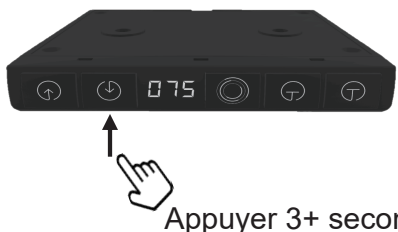



Réinitialiser la console de commande



En position basse ou lorsque le message "protection et alarme" s'affiche. Appuyez sur la flèche vers le bas  pendant plus de 3 secondes. La table descend complètement et remonte jusqu'à une hauteur prédéfinie ; la réinitialisation est alors terminée.

Remarque : Les objets placés sous la table doivent être retirés avant l'opération de réinitialisation afin d'éviter d'endommager la table ou d'autres objets.

Protection et Alarme

-  **Anti-interférence** : le message/alarme "E02" apparaît lorsque le bureau vibre, est interféré ou penche pendant un réglage. Arrêtez immédiatement le réglage et inversez le mouvement; après un certain ajustement, l'alarme disparaîtra.
-  **Protection contre la surchauffe** : le message/alarme "Chaud" apparaît lorsque le temps de réglage continu dépasse 2 minutes, la protection contre la surchauffe sera déclenchée. Arrêtez immédiatement le réglage; attendez 18 minutes après quoi l'alarme disparaîtra.
-  **Protection contre les pannes de moteur** : le message/alarme "E10" apparaît. La puissance doit être déconnectée, vérifiez à nouveau et assurez-vous que le moteur connecté au contrôleur est sécurisé, puis connectez à la source d'alimentation.
-  **Protection contre la surcharge** : le message/alarme "E20" apparaît lorsque la table est levée en surcharge. Retirez le poids, les objets lourds de la table avant de régler. Si une surcharge se produit lors de l'abaissement de la table, appuyez sur  pendant 3+ secondes pour réinitialiser.
-  **Protection contre le désalignement** : le message/alarme "E60" apparaît (systèmes à plusieurs moteurs uniquement!). La puissance doit être déconnectée, vérifiez à nouveau et assurez-vous que le moteur connecté au contrôleur est sécurisé, puis connectez à la source d'alimentation pour réinitialiser.

Guía de usuario

IMPORTANTE: Debe restablecer el escritorio antes del uso.

Asegúrese de que no haya obstáculos en el camino del escritorio.

Asegúrese de que el escritorio no toque ninguna pared.

Asegúrese de que todos los cables tengan la longitud adecuada para adaptarse al cambio de altura.



Aviso

Mientras sube o baja la mesa, asegúrese de que los objetos estén seguros sobre la mesa y que nada impida que la mesa suba o baje en el rango de ajuste deseado.

Sugerencia

Establezca la altura de la mesa preferida mientras está sentado presionando la "tecla de memoria de posición sentada" y la altura de la mesa preferida mientras está de pie presionando la "tecla de memoria de altura de pie".

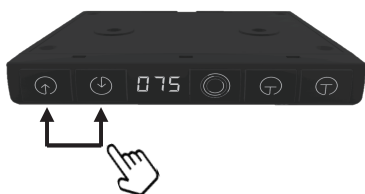

Ajuste de altura de la mesa

Presione hacia arriba o hacia abajo para subir o bajar la mesa a la altura de mesa preferida.

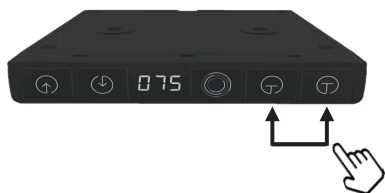

Presione 3+ segundos

Preajustes de memoria

En la altura de la mesa inferior preferida para trabajar sentado, presione la tecla izquierda durante más de 3 segundos para configurar la memoria.

A la altura de la mesa alta preferida para trabajar de pie, presione el botón derecho durante más de 3 segundos para configurar la memoria.

Uso de teclas de memoria

Presione brevemente la tecla izquierda y suéltela, la mesa se moverá a la altura de trabajo sentado preferida.

Presione brevemente la tecla derecha y suéltela, la mesa se moverá a la altura de trabajo de pie preferida.

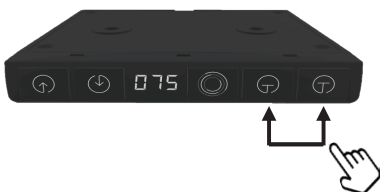

El ajuste de la mesa se detiene presionando cualquier tecla en el panel de control.

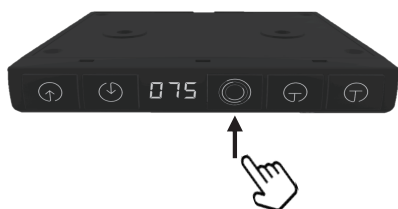

Modo HSM

Cuando la luz parpadea, la mesa se moverá lentamente hacia arriba 12 cm en 3 minutos, se detendrá durante 2 minutos y luego se moverá lentamente hacia abajo 12 cm en 3 minutos. Después de 2 minutos, los movimientos se repetirán.

Encendido / apagado

1. Pulse la tecla  para encender el sistema de operación; la luz de fondo se encenderá.
2. El sistema se apaga automáticamente después de 4 horas.

* Si utiliza otras teclas, la luz de fondo se apagará.

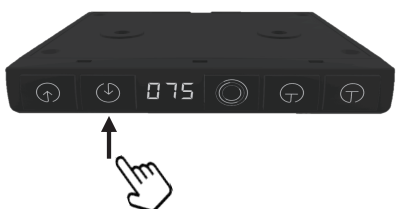







Presione 3+ segundos

Restablecer panel de control

En la posición más baja o cuando lo solicite el mensaje de "protección y alarma", presione la flecha hacia abajo  durante más de 3 segundos, la mesa se mueve completamente hacia abajo y se elevará a una altura preestablecida, momento en el que se completa el resto.

Aviso: Los objetos debajo de la mesa deben retirarse antes de la operación de reinicio para evitar daños a la mesa u otros elementos.

Protección y alarma

-  Anti-interferencia: aparece el mensaje/alarma "E02" cuando el escritorio vibra, interfiere o se inclina durante un ajuste. Detenga el ajuste inmediatamente e invierta el movimiento; después de un cierto ajuste, la alarma desaparecerá.
-  Protección contra sobrecalentamiento: aparece el mensaje/alarma "Hot" cuando el tiempo de ajuste continuo supera los 2 minutos, se activará la protección contra sobrecalentamiento. Detenga el ajuste inmediatamente; espere 18 minutos después de lo cual la alarma desaparecerá.
-  Protección contra mal funcionamiento del motor: aparece el mensaje/alarma "E10". Se debe desconectar la energía, volver a verificar y asegurarse de que el motor conectado al controlador esté seguro, conéctelo a la fuente de energía.
-  Protección contra sobrecarga: aparece el mensaje/alarma "E20" cuando la mesa se eleva mientras está sobrecargada. Retire peso, objetos pesados de la mesa antes de los ajustes. Si se produce una sobrecarga al bajar la mesa, presione  durante más de 3 segundos para volver a sentarse.
-  Protección fuera de sincronismo: aparece el mensaje/alarma "E60" (solo sistemas multomotor). Se debe desconectar la alimentación, volver a verificar y asegurarse de que el motor conectado al controlador esté seguro, conectarlo a la fuente de alimentación para restablecerlo.

Manual do utilizador

IMPORTANTE: É necessário reiniciar a secretária antes de a utilizar.
 Certifique-se de que não existem obstáculos no trajeto da secretária.
 Certifique-se de que a secretária não está a tocar em nenhuma parede.

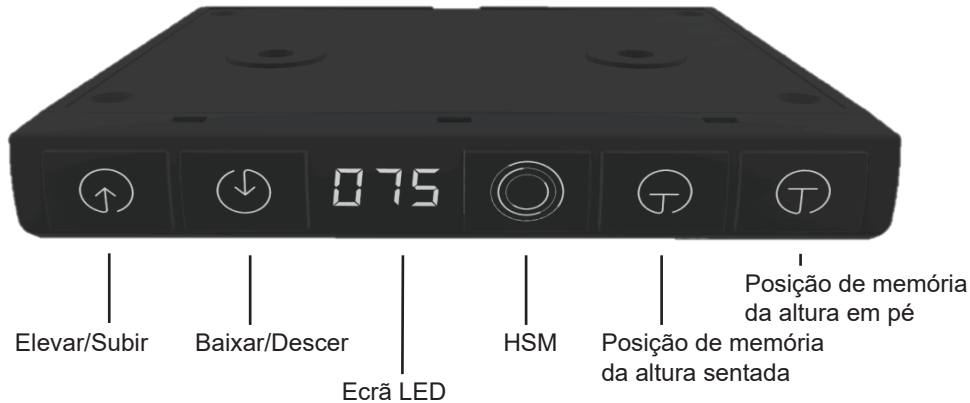

Aviso

Ao levantar ou baixar a mesa, certifique-se de que os objetos estão bem fixos na mesa e que nada impede que a mesa se levante ou baixe até ao intervalo de regulação pretendido.

Sugestão

Defina a altura preferida da mesa na posição sentada, premindo a "tecla de memória da posição sentada", e a altura preferida da mesa na posição de pé, premindo a "tecla de memória da altura de pé".

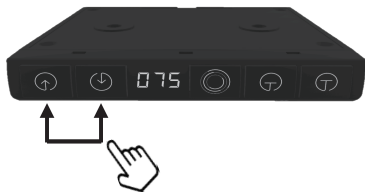

Ajuste da altura

Prima para cima ↑ ou ↓ para baixo para subir ou descer a mesa até à altura de mesa preferida.

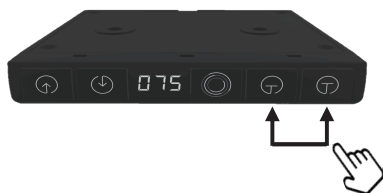

Prima por 3 segundos

Predefinições de memória

Na altura inferior preferida da mesa para trabalho sentado, prima o botão esquerdo ⊕ durante mais de 3 segundos para definir a memória.

Na altura preferida da mesa para trabalho em pé, prima o botão direito ⊖ durante mais de 3 segundos para definir a memória.

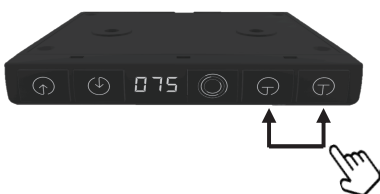

Utilização das teclas de memória

Premir brevemente a tecla esquerda ⊕ e voltar a premir, a mesa deslocar-se-á para a altura de trabalho sentado preferida.

Se premir brevemente a tecla direita ⊖ e voltar a premir, a mesa desloca-se para a altura de trabalho em pé preferida.



O ajuste da mesa pára ao premir qualquer tecla no painel de controlo.

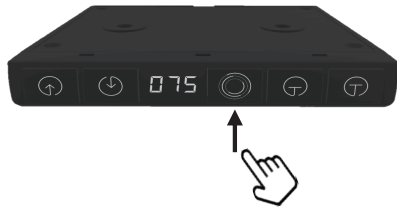

Modo HSM

Quando a luz está a piscar, a mesa sobe lentamente 12 cm em 3 minutos, pára durante 2 minutos e, em seguida, desce lentamente 12 cm em 3 minutos. Após 2 minutos, os movimentos repetem-se.

Ligar/Desligar

1. Prima a tecla  para ligar o sistema de funcionamento; a luz de fundo acende-se.
2. O sistema desliga-se automaticamente após 4 horas.

* Se utilizar outras teclas, a luz de fundo estará desligada.

Reiniciar o painel de controlo

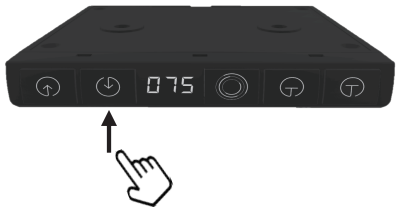







Prima por 3 segundos

Na posição mais baixa ou quando a mensagem de "proteção e alarme" for apresentada, prima a seta para baixo  durante mais de 3 segundos; a mesa desce totalmente e sobe até uma altura predefinida, altura em que o repouso é concluído.

Aviso: Os objetos debaixo da mesa devem ser retirados antes da operação de reposição para evitar danos na mesa ou noutros itens.

Proteção e Alarme

-  Anti-interferência: A mensagem/alarme "E02" aparece quando a secretária vibra, sofre interferências ou se inclina durante um ajuste. Parar imediatamente a regulação e inverter o movimento; após uma determinada correção, o alarme desaparece.
-  Proteção contra o sobreaquecimento: A mensagem/alarme "Hot" (quente) aparece quando o tempo de ajuste contínuo excede 2 minutos, a proteção contra o sobreaquecimento será acionada. Parar imediatamente a regulação; aguardar 18 minutos, após os quais o alarme desaparece.
-  Proteção contra o mau funcionamento do motor: Aparece a mensagem/alarme "E10". A alimentação deve ser desligada, voltar a verificar e assegurar que o motor ligado ao controlador está seguro, ligar à fonte de alimentação.
-  Proteção contra sobrecarga: Aparece a mensagem/alarme "E20" quando a mesa é levantada quando está sobrecarregada. Retirar o peso e os objetos pesados da mesa antes de proceder às regulações. Se ocorrer uma sobrecarga ao baixar a mesa, prima o botão  durante 3+ segundos para voltar a colocar a mesa.
-  Proteção contra falta de sincronização: Aparece a mensagem/alarme "E60" (apenas em sistemas com vários motores). A alimentação deve ser desligada, volte a ligar e certifique-se de que o motor ligado ao controlador está seguro, ligue à fonte de alimentação para reiniciar.

Benutzeranleitung

WICHTIG: Setzen Sie den Tisch vor der Benutzung zurück.

Vergewissern Sie sich, dass sich keine Hindernisse im Weg des Tisches befinden.

Stellen Sie sicher, dass die Tischplatte keine Wände berührt.

Vergewissern Sie sich, dass alle Kabel die richtige Länge haben, um die Höhenverstellung zu ermöglichen.

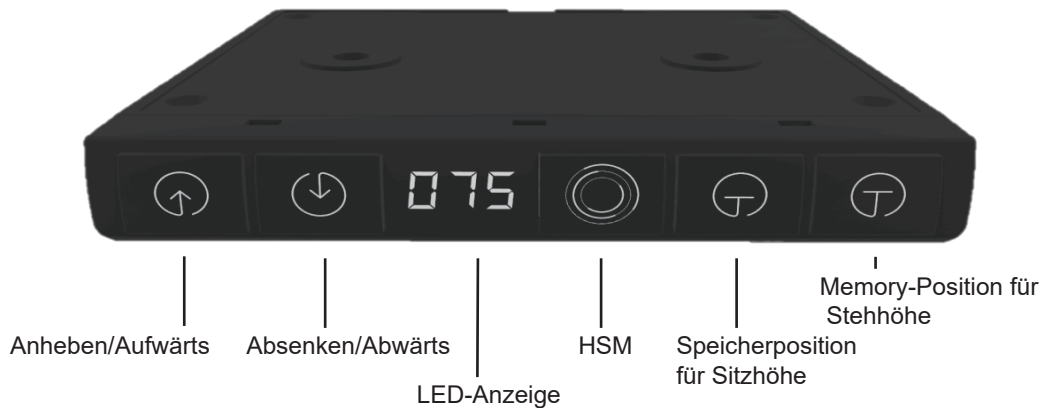

Hinweis



Achten Sie bitte beim Verstellen des Tisches darauf, dass Gegenstände sicher auf dem Tisch befestigt sind und nichts den Tisch daran hindert, über den gewünschten Verstellbereich hinaus angehoben oder abgesenkt zu werden.

Vorschlag

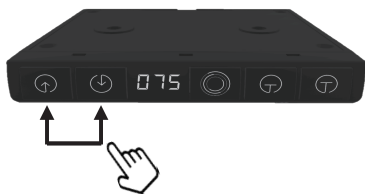
Bitte stellen Sie die gewünschte Tischhöhe zum Sitzen durch Drücken der „Speichertaste für Sitzposition“ und die gewünschte Tischhöhe zum Stehen durch Drücken der „Speichertaste für Stehhöhe“ ein.



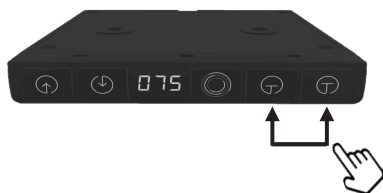

Tischhöhe einstellen

Drücken Sie die Taste nach oben  oder nach unten , um den Tisch auf die gewünschte Höhe anzuheben bzw. abzusenken.





3+ Sekunden drücken

Speicher Voreinstellungen

Bei niedrigerer Tischhöhe für Arbeiten im Sitzen. Drücken Sie die linke Taste  3+ Sekunden lang, um den Speicher einzustellen. In der gewünschten höheren Tischhöhe für stehendes Arbeiten. Drücken Sie die rechte Taste  für 3+ Sekunden, um den Speicher einzustellen.

Verwendung der Speichertasten

Taste links  kurz drücken und loslassen. Der Tisch fährt auf die gewünschte Sitzarbeitshöhe.

Taste rechts  kurz drücken und loslassen, um den Tisch auf die gewünschte Steharbeitshöhe zu fahren.



Um die Tischverstellung zu stoppen, drücken Sie eine beliebige Taste auf dem Bedienfeld.

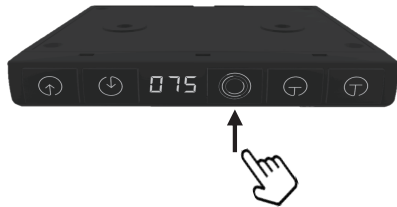

HSM-Modus

Wenn das Licht blinkt, bewegt sich der Tisch innerhalb von 3 Minuten langsam um 12 cm nach oben. Er stoppt für 2 Minuten und bewegt sich dann für 3 Minuten langsam um 12 cm nach unten. Die Bewegungen wiederholen sich nach 2 Minuten.

Strom EIN/AUS

1. Drücken Sie die Taste , um das Betriebssystem einzuschalten; die Hintergrundbeleuchtung leuchtet auf;
2. Das System schaltet sich nach 4 Stunden automatisch AUS.

*Bei Betätigung anderer Tasten ist die Hintergrundbeleuchtung ausgeschaltet.

Steuerkreuz zurücksetzen









3+ Sekunden drücken

In der untersten Position oder wenn Sie durch die Meldung „Schutz und Alarm“ dazu aufgefordert werden. Drücken Sie die Pfeiltaste nach unten  mindestens 3 Sekunden lang. Der Tisch bewegt sich ganz nach unten und hebt sich auf die voreingestellte Höhe, so dass das Zurücksetzen dann abgeschlossen ist.

Hinweis: Gegenstände, die sich unter dem Tisch befinden, sollten vor dem Zurücksetzen entfernt werden, um eine Beschädigung des Tisches oder anderer Gegenstände zu vermeiden.

Schutz und Alarm

-  Schutz vor Störungen: Die Meldung/der Alarm „E02“ erscheint, wenn die Tischplatte während der Verstellung vibriert, gestört wird oder kippt. Die Verstellung sofort stoppen und die Bewegung umkehren; der Alarm verschwindet nach einer bestimmten Verstellung.
-  Überhitzungsschutz: Die Meldung/der Alarm „Heiß“ erscheint, wenn die ununterbrochene Verstellzeit mehr als 2 Minuten beträgt, dann wird der Überhitzungsschutz ausgelöst. Die Verstellung sofort stoppen; 18 Minuten warten, dann verschwindet der Alarm.
-  Motorschutz: Meldung/Alarm „E10“ erscheint. Strom abschalten, erneut prüfen und sicherstellen, dass der an die Steuerung angeschlossene Motor sicher ist, an die Stromquelle anschließen.
-  Überlastschutz: Meldung/Alarm „E20“ erscheint, wenn der Tisch bei Überlast angehoben wird. Entfernen Sie vor der Verstellung Gewichte und schwere Gegenstände vom Tisch. Wenn beim Absenken des Tisches eine Überlast  auftritt, drücken Sie die Taste für 3+ Sekunden, zum Zurücksetzen.
-  Synchronisationsfehler: Meldung/Alarm „E60“ erscheint (nur bei Systemen mit mehreren Motoren!). Strom abschalten, erneut prüfen, ob der an die Steuerung angeschlossene Motor sicher ist und zum Zurücksetzen an die Stromquelle anschließen.

Guida per l'utente

IMPORTANTE: è obbligatorio resettare la scrivania prima dell'uso.

Assicurarsi che non vi siano ostacoli in mezzo alla scrivania.

Assicurarsi che la scrivania non tocchi le pareti.

Assicurarsi che tutti i cavi siano di lunghezza adeguata per adattarsi alla regolazione di altezza.



Avviso

Ao levantar ou baixar a mesa, certifique-se de que os objetos estão bem fixos na mesa e que nada impede que a mesa se levante ou baixe até ao intervalo de regulação pretendido.

Suggerimento

Impostare l'altezza preferita della scrivania quando ci si siede premendo il tasto "memoria posizione seduta" e l'altezza preferita della scrivania quando stai in piedi premendo il tasto "memoria altezza in piedi".

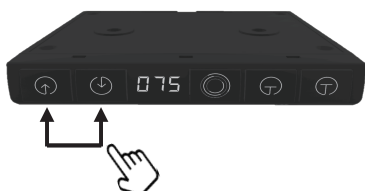

Regolazione dell'altezza della scrivania

Premere o per sollevare o abbassare il piano della scrivania all'altezza preferita.

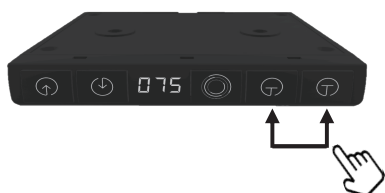

Tenere premuto il tasto per +3s

Preimpostazione Memoria

All'altezza inferiore della scrivania preferita per il lavoro da seduti, premere il tasto sinistro per più di 3 secondi per impostare la seduta memorizzata. All'altezza superiore della scrivania preferita per il lavoro in piedi, premere il tasto destro per più di 3 secondi per impostare la memoria.

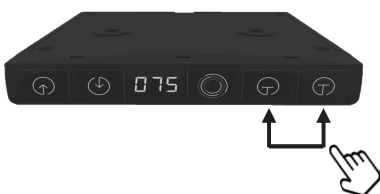

Uso del Tasto Memoria

Premere brevemente il tasto sinistro e rilasciarlo. la scrivania si sposterà all'altezza preferita per il lavoro da seduti. Premendo brevemente il tasto destro e rilasciarlo, la scrivania si sposterà all'altezza preferita per il lavoro in piedi.

La regolazione della scrivania si arresta premendo un tasto qualsiasi del pannello

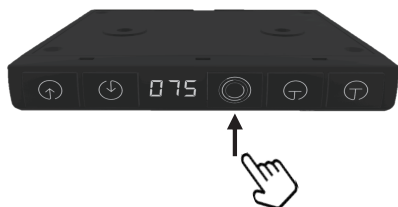

Modalità HSM

Quando la luce lampeggia, la scrivania si sposta lentamente di 12 cm in 3 minuti. Successivamente, si ferma per 2 minuti e poi si abbassa lentamente di 12 cm in 3 minuti. Dopo 2 minuti, i movimenti si ripetono.

Alimentazione ON/OFF

1. Premere il tasto  per accendere il sistema operativo; la luce della retroilluminazione si accende;
2. Il sistema si spegne automaticamente dopo 4 ore.
*Se si premono altri tasti, la retroilluminazione si spegne.

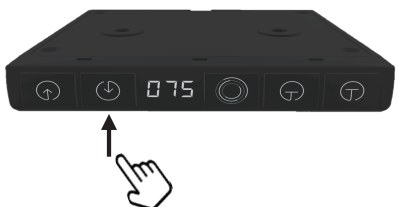







Tenere premuto per +3s

Resetare il pannello di controllo

Nella posizione più bassa o quando viene visualizzato il messaggio "protezione e allarme", premere la freccia verso il basso  per più di 3 secondi e la scrivania si sposta completamente verso il basso e si solleva a un'altezza preimpostata; a questo punto il reset è completato.

Gli oggetti sotto la scrivania devono essere rimossi prima dell'operazione di reset per evitare di danneggiare la scrivania o altri oggetti.

Protezione e Allarme

-  **Anti-interferenza:** appare il messaggio/allarme "E02" quando il piano della scrivania vibra, subisce interferenze o si inclina durante una regolazione. Interrompere immediatamente la regolazione e invertire il movimento; dopo una certa regolazione l'allarme scompare.
-  **Protezione contro il surriscaldamento:** appare il messaggio/allarme "Hot" quando il tempo di regolazione continua supera i 2 minuti, e si attiva la protezione contro il surriscaldamento. Interrompere immediatamente la regolazione; attendere 18 minuti e dopodiché l'allarme scomparirà.
-  **Protezione da malfunzionamento del motore:** appare il messaggio/allarme "E10". È necessario scollegare l'alimentazione, ricontrollare e assicurarsi che il motore collegato al regolatore sia sicuro. In seguito, occorre collegarlo alla fonte di alimentazione.
-  **Protezione da sovraccarico:** appare il messaggio/allarme "E20" quando il piano della scrivania viene sollevato mentre è sovraccaricato. Rimuovere il peso e gli oggetti pesanti dalla scrivania prima di effettuare le regolazioni. Se si verifica un sovraccarico quando si abbassa la scrivania, tenere premuto il tasto  per più di 3 secondi per resettare.
-  **Protezione Fuori Sincronia:** appare il messaggio/allarme "E60" (solo per sistemi multimotore). È necessario scollegare l'alimentazione, ricontrollare e assicurarsi che il motore collegato al controller sia sicuro, collegare alla fonte di alimentazione per il reset.

US_ IMPORTER:

Imported by Aosom LLC
27150 SW Kinsman Rd Wilsonville, OR 97070 USA
MADE IN CHINA

CA_ IMPORTER / IMPORTÉ PAR:

Imported by Aosom Canada Inc.
7270 Woodbine Avenue, Unit 307, Markham, Ontario Canada L3R 4B9
MADE IN CHINA

Importé par Aosom Canada Inc.
7270 Woodbine Avenue, unité 307, Markham, Ontario Canada L3R 4B9
Fabriqué en Chine

UK_ IMPORTER:

MH STAR UK LTD
Unit 27, Perivale Park, Horsenden lane South
Perivale, UB6 7RH
MADE IN CHINA

DE_ IMPORTATEUR:

MH Handel GmbH
Wendenstraße 309
D-20537 Hamburg
Germany
IN CHINA HERGESTELLT

FR_ IMPORTÉ PAR:

MH France
2, rue Maurice Hartmann
92130 Issy-les-Moulineaux
France
Fabriqué en Chine



FR
Pensez à
donner ou recycler.



Association

OU



Magasin

OU



Déchèterie

<https://quefairedemesdechets.fr>

IT_ IMPORTATO:

AOSOM Italy srl
Centro Direzionale Milanofiori
Strada 1 Palazzo F1
20057 Assago (MI)
P.I.: 08567220960
FATTO IN CINA

ES/PT_ IMPORTADOR:

SPANISH AOSOM, S.L.
C/ ROC GROS, N° 15. 08550, ELS HOSTALET DE
BALENYÀ, SPAIN.
B66295775
WWW.AOSOM.ES
ATENCIONCLIENTE@AOSOM.ES
TEL: 931294512
HECHO EN CHINA

SPANISH AOSOM, S.L
C.ROC GROS N.15, 08550. ELS HOSTALET DE BALENYÀ
TEL: 931294512 (SEG-SEX DAS 7:30H ÀS 16:30H)
INFO@AOSOM.PT
WWW.AOSOM.PT