

**MOTORCYCLE TOP BOX
MOTORRAD-AUFSATZ BOX
BAULETTO PER MOTO
CAJA SUPERIOR DE MOTOCICLETA
BAÚ PARA MOTOCICLETA**

**EN_IMPORTANT, RETAIN FOR FUTURE REFERENCE: READ CAREFULLY.
DE_WICHTIG! SORGFÄLTIG LESEN UND FÜR SPÄTER NACHSCHLAGEN AUFBEWAHREN.
IT_IMPORTANTE! CONSERVARE IL PRESENTE MANUALE PER FUTURO RIFERIMENTO E
LEggerlo ATTENTAMENTE.
ES_IMPORTANTE, LEA Y GUARDE PARA FUTURAS REFERENCIAS.
PT_IMPORTANTE, GUARDE PARA FUTURA REFERÊNCIA, LEIA ATENTAMENTE**

EN

SAFETY INSTRUCTIONS

WARNING - Due to the variety in motorcycles and scooters, it is the user's full responsibility to ensure no damage occurs whilst using this top box. Correct attachment of the top box to the vehicle is therefore critical and is beyond control of the manufacturer, distributor or supplier.

- Every time before use check the carrier for security of fittings or any sign of wear and tear. Replace any worn or damaged parts.
- DO NOT use the cycle carrier if any parts are missing or damaged as this may cause failure and/or personal injury.
- Ensure that the top box is locked before riding the vehicle.

DE

SICHERHEITSHINWEISE

WARNUNG - Aufgrund der Vielzahl von Motorrad- und Rollermodellen ist der Benutzer selbst dafür verantwortlich, dass bei der Verwendung dieser Aufsatzbox keine Schäden entstehen. Die korrekte Befestigung der Aufsatzbox am Fahrzeug ist daher von entscheidender Bedeutung und liegt außerhalb der Kontrolle des Herstellers, des Händlers oder des Lieferanten.

- Überprüfen Sie vor jeder Verwendung dieses Produkts, ob alle Verbindungsstücke sicher befestigt sind, und achten Sie auf Anzeichen von Verschleiß. Bitte stellen Sie sicher, dass verschlissene oder beschädigte Teile ausgetauscht werden.
- Verwenden Sie dieses Produkt NICHT, wenn Teile fehlen oder beschädigt sind, da dies zu einem Produktausfall und / oder zu Verletzungen führen kann.
- Stellen Sie sicher, dass die Aufsatzbox verriegelt ist, bevor Sie mit dem Fahrzeug fahren.

IT

ISTRUZIONI DI SICUREZZA

AVVERTENZE - A causa della varietà di motociclette e scooter, è responsabilità dell'utente assicurarsi che non si verifichino danni durante l'utilizzo di questo bauletto. Il corretto fissaggio del bauletto al veicolo è quindi fondamentale ed è al di fuori del controllo del produttore, distributore o fornitore.

- Ogni volta prima dell'uso, controllare il supporto per la sicurezza dei raccordi o qualsiasi segno di usura. Sostituire eventuali parti usurate o danneggiate.
- NON utilizzare il bauletto in caso di parti mancanti o danneggiate poiché ciò potrebbe causare guasti e / o lesioni personali.
- Accertarsi che il bauletto sia bloccato prima di guidare il veicolo.

ES

INSTRUCCIONES DE SEGURIDAD

ADVERTENCIA: Debido a la variedad de motocicletas y scooters, el usuario es responsabilidad exclusiva para asegurarse de que no se produzcan daños al usar esta caja superior. La fijación correcta de la caja superior al vehículo es crítica y está fuera del control del fabricante, distribuidor o proveedor.

- Antes de cada uso, verifique el portabicicleta para mantener la seguridad de los accesorios o cualquier signo de desgaste. Reemplace cualquier pieza desgastada o dañada.
- NO use el portabicicletas si faltan piezas o si están dañadas, porque esto puede causar fallas y / o lesiones personales.
- Asegúrese de que la caja superior esté bloqueada antes de conducir el vehículo.

PT

INSTRUÇÕES DE SEGURANÇA

AVISO: Devido à variedade de motos e scooters, é da exclusiva responsabilidade do utilizador assegurar que não ocorram danos ao utilizar este baú. A fixação correcta ao veículo é fundamental e está fora do controlo do fabricante, concessionário ou fornecedor.

- Antes de cada utilização, verificar o baú para motocicletas esta seguro ou com quaisquer sinais de desgaste, para manter a segurança dos acessórios. Substituir quaisquer peças desgastadas ou danificadas.
- NÃO utilizar o baú se faltarem ou forem danificadas peças, pois isto pode causar falhas e/ou danos pessoais.
- Certifique-se de que o baú está trancado antes de conduzir o veículo.

PARTS

A x 4



B x 4

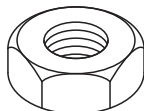

C x 4

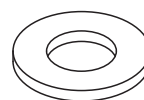

D x 4



E x 4

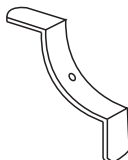

F x 1

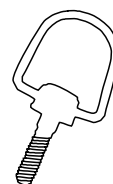

G x 1



H x 2



I x 1



J x 1

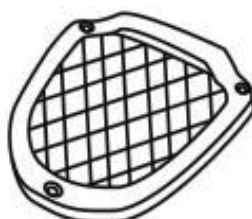

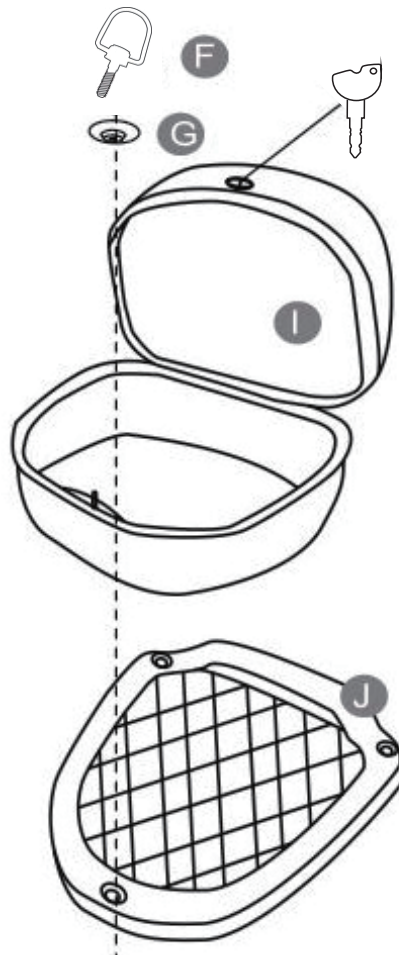
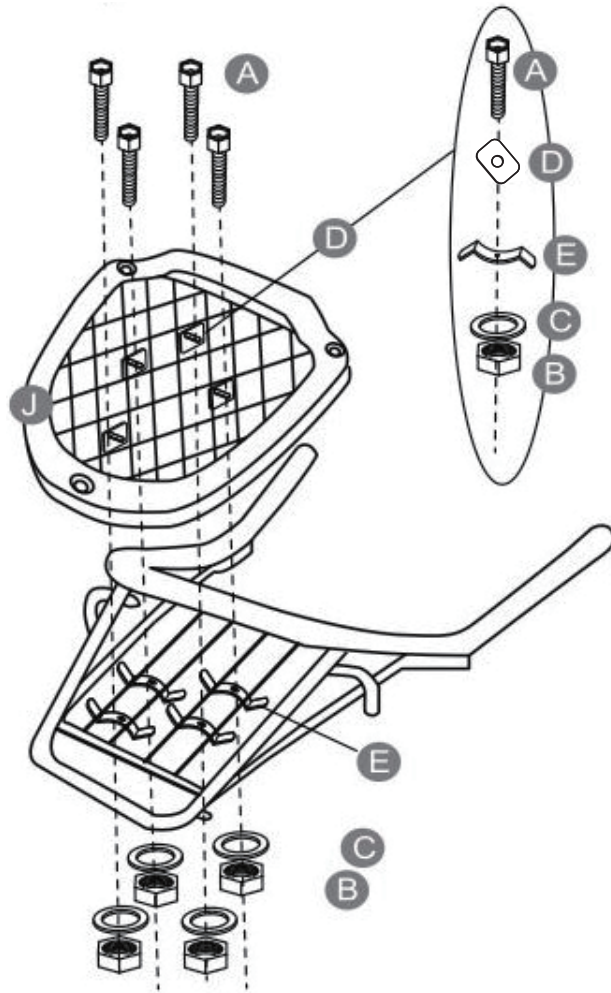

If you have any questions, please contact our customer care center.

Our contact details are below:

 001-877-644-9366

 customerservice@aosom.com

Imported by Aosom LLC

27150 SW Kinsman Rd Wilsonville, OR 97070 USA

MADE IN CHINA

US

Si tiene alguna pregunta, comuníquese con nuestro Centro de Atención al Cliente.

Nuestros datos de contacto son los siguientes:

 0034-931294512

 atencioncliente@aosom.es

IMPORTADOR/Fabricante/REP:

SPANISH AOSOM, S.L.

C/ ROC GROS, Nº 15. 08550, ELS HOSTALETES DE BALENYÀ, SPAIN.

B66295775

WWW.AOSOM.ES

HECHO EN CHINA

ES

If you have any questions, please contact our customer care center.

Our contact details are below:

 416-792-6088

 customerservice@aosom.ca

Imported by Aosom Canada Inc.

7270 Woodbine Avenue, Unit 307, Markham,

Ontario Canada L3R 4B9

MADE IN CHINA

CA

Si vous avez la moindre question, veuillez contacter notre centre d'assistance à la clientèle.

Nos coordonnées sont les suivantes:

 416-792-6088

 customerservice@aosom.ca

Importé par Aosom Canada Inc.

7270 Woodbine Avenue, unité 307,

Markham, Ontario Canada L3R 4B9

Fabriqué en Chine

PT

Se tiver alguma dúvida, por favor contacte o nosso Centro de Atendimento ao Cliente.

Os nossos dados de contacto são os seguintes:

 0034-931294512 (SEG-SEX DAS 7:30H ÀS 16:30H)

 info@aosom.pt.

IMPORTADOR/Fabricante/REP:

SPANISH AOSOM, S.L

C.ROC GROS N.15, 08550. ELS HOSTALETES DE BALENYÀ

WWW.AOSOM.PT

DE

Wenn Sie Fragen haben, wenden Sie sich bitte an unser Kundendienstzentrum.

Unsere Kontaktdaten stehen unten:

 0049-0(40)-88307530  service@aosom.de

ADRESSE DES IMPORTEURE/Hersteller/REP:

MH Handel GmbH

Wendenstraße 309

D-20537 Hamburg

Germany

IN CHINA HERGESTELLT

WWW.AOSOM.DE

IT

In caso di dubbio, si prega di contattare il nostro centro assistenza clienti.

I nostri dettagli di contatto sono di seguito:

 0039-0249471447  clienti@aosom.it

IMPORTATO DA/Produttore/REP:

AOSOM Italy srl

Centro Direzionale Milanofiori

Strada 1 Palazzo F1

20057 Assago (MI)

P.I.: 08567220960

FATTO IN CINA

WWW.AOSOM.IT

If you have any questions, please contact our customer care center.

Our contact details are below:

 0044-800-240-4004

 enquiries@mhstar.co.uk

IMPORTER ADDRESS:

MH STAR UK LTD

Unit 27, Perivale Park,

Horsenden lane South

Perivale, UB6 7RH

MADE IN CHINA

UK

Si vous avez la moindre question, veuillez contacter notre centre d'assistance à la clientèle.

Nos coordonnées sont les suivantes:

 0033-1-84166106

 aosom@mhfrance.fr

Importé par/Fabricant/REP:

MH France

2, rue Maurice Hartmann

92130 Issy-les-Moulineaux

France

Fabriqué en Chine

WWW.AOSOM.FR

FR