

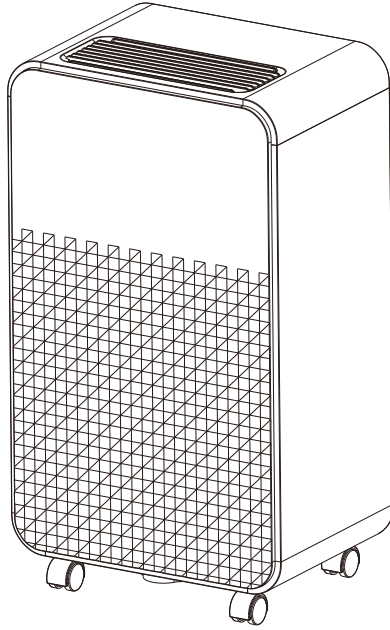

IN230500577V01_UK

821-027V70_821-027V71



Dehumidifier

**UK
CA**

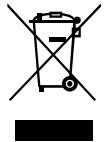

IMPORTANT, RETAIN FOR FUTURE REFERENCE: READ CAREFULLY

INSTRUCTION MANUAL

CONTENTS

| | |
|--|----|
| ■ <i>Precautions</i> | 2 |
| ■ <i>Operation panel</i> | 5 |
| ■ <i>Operation and efficiency</i> | 6 |
| ■ <i>Part names and functions</i> | 8 |
| ■ <i>Preparation and checking before operation</i> | 9 |
| ■ <i>Preparations and inspection while beginning the operation</i> | 10 |
| ■ <i>Maintenance notices</i> | 12 |
| ■ <i>Malfunction disposals</i> | 14 |
| ■ <i>Performance parameters</i> | 15 |

**Thank you for choosing this dehumidifier.
Please read this instruction manual carefully
before installing this appliance. Keep this manual
safe for future reference.**

Precautions

SAFETY INSTRUCTIONS

PLEASE READ AND SAVE THESE IMPORTANT SAFETY INSTRUCTIONS.

When using electrical appliances, always follow basic safety precautions to reduce the risk of fire, electric shock and injury to persons. These include the following:



WARNING: To avoid the risk of electric shock, fire or injury to persons, always unplug the appliance before moving, servicing or cleaning it.

- Use this appliance only as described in this manual. Any other use not recommended by the manufacturer may cause fire, electric shock or injury to persons.
- The appliance is not to be used by persons (including children) with reduced physical, sensory or mental capabilities, or lack of experience and knowledge unless they have been given supervision or instruction.
- Never place anything on top of the appliance.
- Small children must be constantly supervised when near this appliance.
- Do not cover the appliance whilst in use.
- Do not submerge the appliance in water.
- Dispose of water collected from the appliance. This water is not drinkable.
- Ensure there is at least 50cm of space on all sides of the appliance.
- Do not leave children alone or unattended when the appliance is in use.
- Children must not clean or maintain this appliance unless continuously supervised.
- Place the appliance on a flat, stable and dry surface, ensuring it is in an upright position. Operating the appliance in any other position could be hazardous.
- Do not place the appliance against a wall or other appliances.
- Do not cover the appliance or restrict the airflow of the inlet or exhaust grills whilst in use.
- Do not operate the appliance with wet hands.
- Do not use this appliance near water or in the immediate surroundings of a bathtub, shower or swimming pool.
- Ensure water or other liquids do not get into the interior of the appliance - this can cause a fire or electrical hazard.
- Do not use mechanical devices to accelerate the appliance's defrosting process.
- Do not place the continuous drainage hose outside when the temperature falls below 1°C.
- Do not use the appliance without the air filter.
- This appliance is intended for indoor household use. Do not use outdoors.
- Never leave the appliance unattended while in use. Always turn off and unplug the appliance when not in use.
- Avoid placing the power cord in areas where it can become a tripping hazard. Do not place the power cord under carpeting or cover it with rugs, runners or anything similar.
- To avoid a circuit overload when using this appliance, do not operate other high-wattage appliances on the same electrical circuit.
- Always plug the appliance directly into a wall socket. Avoid using extension leads where possible as they may overheat and cause a risk of fire.
- Do not use this appliance with an external programmer, timer switch or any other device which would turn the appliance on automatically unless this has already been built into the appliance by the manufacturer.
- Do not pull on the power cord. Never move, carry or hang the appliance by its power cord.
- Do not kink or wrap the power cord, as this may cause the insulation to weaken or split, particularly where it enters the appliance.

- Only use the appliance with the power adapter provided. Do not use chargers or power adapters - this can damage the product or battery.
- Do not operate the appliance with the water tank removed.
- Ensure the mains cable is fully extended before use, ensuring it does not touch any part of the appliance.
- Do not operate the appliance with the safety guards.
- Do not attempt to adjust or repair any part of this appliance. This is unsafe and will void your warranty.
- Ensure that the mains supply(including voltage, frequency and power) complies with the rating label of the appliance.
- Do not use the appliance near petrol, paint, flammable gases, ovens or other heating sources.
- Never insert fingers or metal objects into the vents and openings of the appliance.
- If there are signs of damage to the appliance, power cord or any of the accessories supplied, do not use this appliance. Damaged supply cords must be replaced by the manufacturer, its service agent or a similarly qualified person to avoid a hazard.

SPECIFIC INFORMATION REGARDING R290 REFRIGERANT GAS

- The appliance must be installed, used and stored in area that is greater than 4m².
- This appliance contains 30g of R290 for the 10L model and 40g for the 12L model refrigerant gas.
- R290 is refrigerant gas that complies with the European directive on the environment. Do not puncture any part of refrigerant circuit.
- Be aware R290 refrigerant is odourless and does not have the odour normally associated with natural gas and propane tanks.
- The appliance must be placed in an area without any continuous sources of ignition such as open flames, gas or electrical appliances in operation.
- Do not puncture and do not burn.
- If the appliance is installed, operated or stored in an area without proper ventilation, the room must be designed in a way that prevents the accumulation of refrigerant leaks. This reduces the risk of fire or explosion that could occur if the leaked refrigerant comes into contact with electric heaters, stoves or other sources of ignition.
- Store the appliance correctly to avoid mechanical failure.
- Individuals who operate or work on the refrigerant circuit must have the appropriate certification issued by an accredited organisation that ensures competence in handling refrigerants according to a specific evaluation recognised by associations in the industry.
- Maintenance and repairs that require the assistance of other qualified personnel must be performed under the supervision of an individual specified in the use of flammable refrigerants.

RECYCLING & DISPOSAL



Waste electrical products should not be disposed of with household waste. Please recycle where facilities exist. Check with your local authority or retailer for recycling advise.



Operation panel

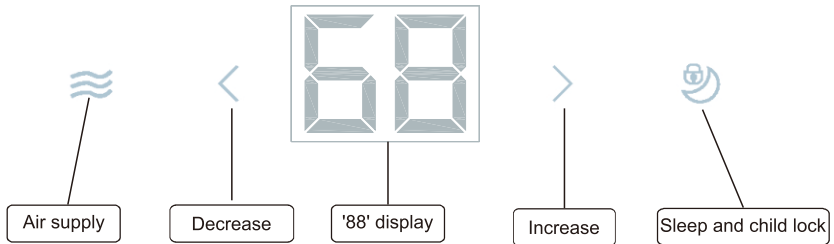
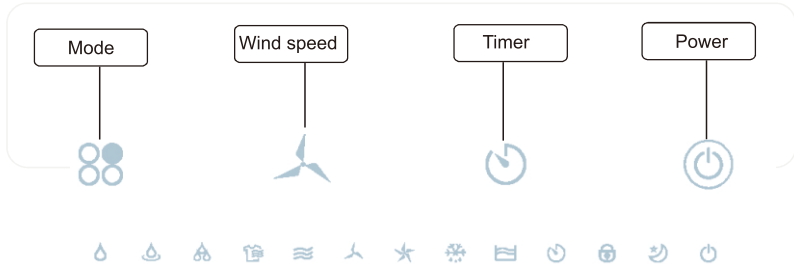

INCREASE BUTTON >

DECREASE BUTTON <

Under the normal dehumidification mode, press one of these buttons to adjust the humidity setting (between 30-80%). Each press changes the number by 5%. The setting cycle is adjustable.





Use these buttons to set the timer.

Operation manual

POWER BUTTON

Press this button to turn the appliance on and off. If there is a negative ion function, the appliance will start automatically. When the appliance turns on, it will make a beeping sound. The default settings are low wind and normal dehumidification mode.

MODE BUTTON

Press this button to cycle through the different modes, which are: normal dehumidification , continuous dehumidification , strong dehumidification  and fast drying .

WIND SPEED BUTTON

This button switches the wind speed between high and low. It can only be used in the ventilation and normal dehumidification mode.

TIMER BUTTON

Press this button to set a timer between 0-24 hours.

AIR SUPPLY BUTTON

Press this button to switch between the current working mode and the ventilation mode. In the ventilation mode, press the wind speed button to switch between high and low wind speeds.

SLEEP AND CHILD LOCK BUTTON

Press the button to enter the sleep mode. Hold the button to activate the child lock function. The machine can still be switched on and off when the child lock is activated. Hold the button again to stop the child lock function.

Operation and efficiency

Defrosting operation

If the appliance is used in a room with a temperature lower than 18 °C, the evaporator may automatically frost.

If this happens, the defrosting device will activate, which will run for approximately five minutes. This process will repeat every 25 minutes.

- During the defrosting process, the dehumidification and air purification functions may stop.
- During the defrosting process, do not turn off or unplug the appliance.

This dehumidifier is not suitable for use in extremely low temperatures. Its main purpose is to effectively remove high humidity in daily life and dry damp items. However, it is not designed to maintain extremely low temperatures.

The room temperature increases during the operation.

This dehumidifier does not have a cooling function. It will produce heat during use and increase the room temperature by 1-4°C. This temperature rise may be very distinct when the appliance is in a cabinet or similar spaces. Closed doors and windows raise the temperature, as well as other appliances and sunlight.

Dehumidifying capacity

The graph below shows the capacity of the dehumidifier. The capacity mentioned is based on a room temperature of 30°C, relative humidity of 80% and the air outlet being fully open. Note: At different temperatures and relative humidity levels, the dehumidifier's capacity may vary. In rooms with the same temperature, the dehumidifier capacity will be higher when the relative humidity is higher, and lower when the relative humidity is lower. Similarly, at the same relative humidity, the dehumidifying capacity will be higher in higher temperatures and lower in lower temperatures. If the appliance is placed inside a cabinet, its dehumidifying capacity may significantly decrease shortly after operation. This occurs because the humidity inside the cabinet is rapidly reduced, resulting in higher levels of dryness.

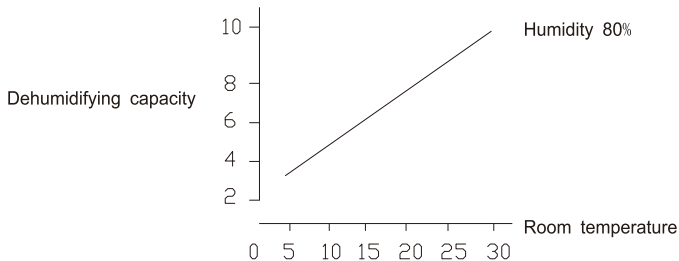

Part Names and Functions

Front

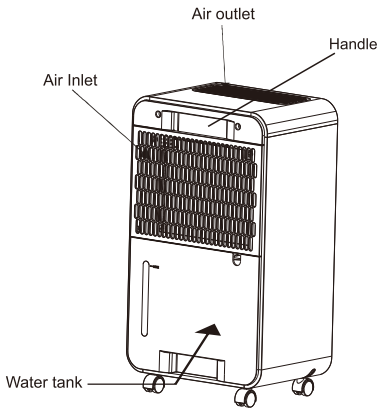

Back

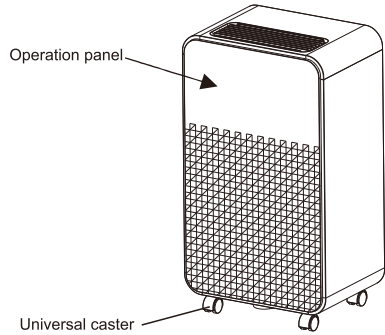

Installation

For efficient use, ensure there is enough space around the appliance (use the picture on the right for reference).

Note

To prevent interference and noise disturbances with electronic devices (TV sets and radios), ensure they are positioned at least 70cm away from the dehumidifier.

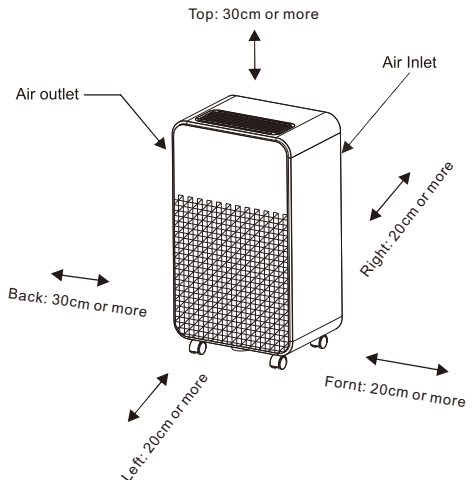

Preparations and inspection while beginning the operation

Ensure the tank is installed properly

The appliance will not work if the tank is full or not installed properly.

1. How to remove the water tank.

Hold the sides of the tank and pull it towards you.

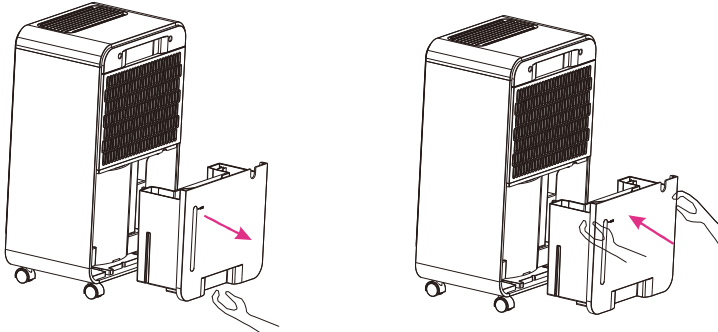

2. How to empty the tank.

- A. Pull the tank out of the appliance.
- B. Tilt the tank in the right direction and empty the water slowly.
- C. Place the tank back into the appliance.

Remark

During use, the tank collects water. When the tank is full, the dehumidifier will automatically stop working and the 'full' indicator light will be on.

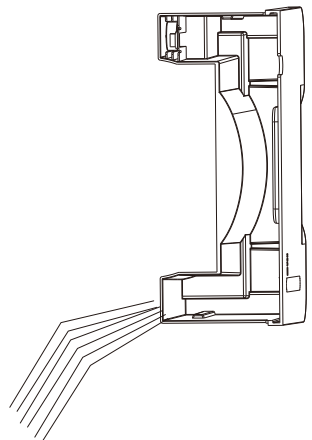

Select proper functions

Lower the indoor humidity to a comfortable level.

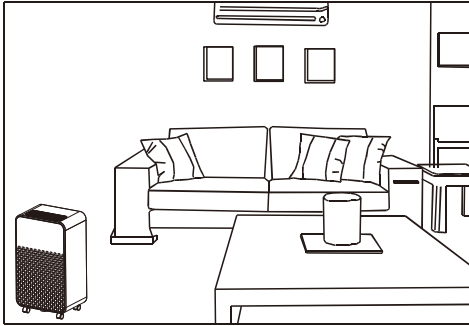

Lower the indoor humidity or prevent condensation and mildew on ceilings or walls.

Dehumidify the wardrobe.

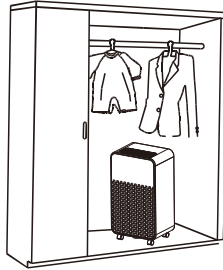

Dehumidifying small spaces.

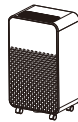

Indoor air filtration.



Maintenance



Warning

Never plug or unplug the appliance with wet hands.



Prohibit wet hand



Notice

Turn off and unplug the appliance before cleaning and maintenance.



Pull off plug

Do not dismantle the floater from the water tank.



Prohibit

If the appliance is not in use for long periods:

1. Empty the tank, wipe it clean and place it back into the appliance.
2. Clean the filter.
3. Keep the unit upright, ensuring it is away from direct sunlight.

Requirement

Keep the appliance upright to avoid malfunctions and unusual sounds.

The appliance body

Wipe the appliance with a slightly damp cloth (do not clean the controls with a wet cloth).

Do not clean the appliance with gasoline, thinner or liquid detergent to avoid deformation.

Do not use chemicals to clean the appliance - it could change its colour.

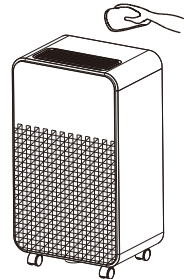

Clean the filter net (maintain every two weeks)

When the filter net is clogged, the dehumidifier capacity could reduce.

Clean very dirty filter nets with a vacuum cleaner.

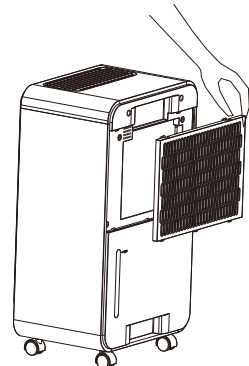

Continuous Drainage

Continuous drainage

If you are away from the appliance but need it to be on, use the continuous drainage feature. Pull the plug, take out the tank and insert the pipe.

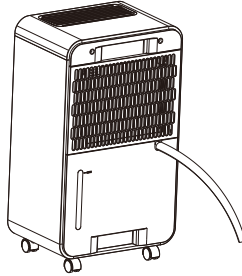

Warning



Prohibit

Keep the power cord away from doors to avoid it getting trapped.



Notice



Prohibit

Keep small children away from the appliance.

Malfunction disposals

Please check each item first before applying for maintenance:

| Malfunction | Possible causes | Solutions |
|--|---|--|
| Appliance does not work. | The power plug is not properly connected. | Firmly plug in the appliance. |
| | The water tank is full | Empty the tank fully. |
| | The tank is not in its correct position. | Ensure the tank is properly placed. |
| Small dehumidifying capacity. | The filter is dirty. | Clean the filter. |
| | The air inlet and outlet are blocked. | Unblock the air inlet and outlet. |
| Appliance makes loud noises. | The appliance is on an unstable surface. | Keep the appliance on a smooth and stable surface. |
| Appliance stops during the dehumidifying process. | Room temperature is too high or low. It could be out of the working range of the appliance. | The appliance will automatically restart when the room temperature returns within the working range. |
| Clothes do not dry quickly. | The room temperature is too low. | Room temperature needs to rise to dry clothes quickly. |

Under normal conditions, without any malfunctions, the following occurrences take place:

| What happens | The cause |
|---|---|
| The appliance pauses during operation. | The defrosting function is activated. |
| The dehumidifying capacity drops. | The dehumidifying capacity drops with the room temperature and humidity. See the illustration above for reference. |
| The humidity of the room does not reduce. | The room area is too big. Doors and windows are open. The machine unit is operated with a kerosene heater, which releases steam together. |
| The appliance makes noises during operation. | The sound produced by the flowing refrigerant may automatically decrease or disappear as the system stabilises during operation. |
| Water is in the tank. | As each machine undergoes an operation test before leaving the factory, any remaining water on the evaporator flows into the tank. |
| The 'FULL' indicator light is on. | This is to remind you that the water tank is full and needs emptying. |

Performance parameters

| | |
|----------------------|---|
| Model No: | 821-027V70 (FDD10-5181R5) |
| Power Supply: | 220V-240V~ 50Hz |
| Dehumidity Capacity: | 10L/ Day (30°C /80 %) 5L/ Day (27°C /60 %) |
| Input Power: | 270W |
| Rated Current : | 1.40A |
| Water Tank Capacity: | 2 L |
| Net weight: | 9kg |
| Dimensions: | Height 490mm, Length 280mm, width 240mm |
| Application scope: | 5 °C-35 °C |
| Refrigerant: | R290/ 30g |

| | |
|----------------------|---|
| Model No: | 821-027V71 (FDD12-5181R5) |
| Power Supply: | 220V-240V~ 50Hz |
| Dehumidity Capacity: | 12L/ Day (30°C /80 %) 6L/ Day (27°C /60 %) |
| Input Power: | 280W |
| Rated Current : | 1.45A |
| Water Tank Capacity: | 2 L |
| Net weight: | 9.5kg |
| Dimensions: | Height 490mm, Length 280mm, width 200mm |
| Application scope: | 5 °C-35 °C |
| Refrigerant: | R290/ 40g |

The parameters above may change with the improvement of the machine unit without further notice.

