

**EN\_IMPORTANT, RETAIN FOR FUTURE REFERENCE: READ CAREFULLY.**

**FR\_IMPORTANT: A LIRE ATTENTIVEMENT ET À CONSERVER POUR CONSULTATION ULTÉRIEURE.**

**ES\_IMPORTANTE, LEA Y GUARDE PARA FUTURAS REFERENCIAS.**

**PT\_IMPORTANTE, RETER PARA REFERÊNCIA FUTURA: LEIA ATENTAMENTE.**

**DE\_WICHTIG! SORGFÄLTIG LESEN UND FÜR SPÄTER NACHSCHLAGEN AUFBEWAHREN.**

**IT\_IMPORTANTE! CONSERVARE IL PRESENTE MANUALE PER FUTURO RIFERIMENTO E LEGGERLO ATTENTAMENTE.**

# **IMPORTANT, RETAIN FOR FUTURE REFERENCE: READ CAREFULLY.**

## **Only for domestic use**

### **Instructions for use:**

- \*Put the chair stably on a flat floor.
- \*Stay away from open flames.
- \*Avoid the overload at the chair.

### **Precautions before assembly:**

- \*Prepare a clean and dry mounting area.
- \*Verify that the product is not damaged.
- \*Check that none of the pieces are missing.

### **Maintenance:**

- \*Clean with a soft fabric.
- \*Check the seating regularly.

### **Storage conditions:**

- \*The fabric should be stored completely dry, in a clean and dry place to avoid the risks of mold.

## **Beware of crushing and cutting hazards during assembly.**

**The manufacturer declines all responsibility in case of damages due to a bad installation or withering.**

**If the seating is fitted with powered seat height adjustments, only trained personnel may replace or repair those components.**

# **IMPORTANT: A LIRE ATTENTIVEMENT ET À CONSERVER POUR CONSULTATION ULTÉRIEURE.**

## **Réservé à un usage domestique**

### **Conseils :**

- \*Placez la chaise sur un sol plat et sec afin qu'elle soit stable
- \*Placer à l'écart des flammes ou de sources de chaleur
- \*Ne pas dépasser la charge maximale autorisée

### **Précautions avant l'assemblage :**

- \*Préparez une zone de montage propre et sèche
- \*Vérifiez que le produit n'est pas endommagé
- \*Vérifiez qu'aucune des pièces de ne manque

### **Recommandations d'entretien :**

- \*Veuillez utiliser un chiffon doux pour essuyer la chaise
- \*Vérifiez régulièrement la structure du produit

### **Conditions de stockage:**

- \*Veuillez stocker le produit dans un environnement propre et sec pour éviter tout risque de moisissure.

**Veillez faire attention à ne pas vous blesser lors de l'assemblage du produit.**

**Le fabricant n'est pas responsable des dommages causés par une mauvaise installation.**

**Si le fauteuil est équipé d'un dispositif de hauteur réglable avec moteur, seule une personne qualifiée peut remplacer ou réparer la partie motorisée.**

# IMPORTANTE, LEA Y GUARDE PARA FUTURAS REFERENCIAS.

## Producto para uso doméstico

### Consejos de uso:

- \* Coloque el producto sobre un suelo plano de forma estable.
- \* Manténgase alejado de fuentes de calor y llamas.
- \* Evite la sobrecarga de los anclajes del producto.

### Precauciones antes del montaje:

- \* Prepare la zona de montaje. Asegúrese de que esté limpia y seca.
- \* Asegúrese de que el producto está en buen estado.
- \* Verifique que no falta ninguna de las piezas.

### Mantenimiento:

- \* Limpie el producto con la ayuda de un paño suave.
- \* Inspeccione el producto de forma regular a fin de detectar posibles daños o desperfectos que puedan afectar a su uso.

### Condiciones de almacenaje:

- \* A fin de evitar la aparición de moho, los tejidos se deben de guardar totalmente secos y en un lugar limpio y sin humedad.

### Atención:

**Riesgo de pinzamientos o cortes durante el montaje.**

**El fabricante declina toda responsabilidad en caso de deterioro debido a una mala instalación o por causas meteorológicas.**

**Si el producto está equipado con algún mecanismo eléctrico de ajuste de altura o similar, solo podrá ser reemplazado o reparado por personal capacitado y técnicos.**

# **IMPORTANTE, RETER PARA REFERÊNCIA FUTURA: LEIA ATENTAMENTE.**

## **Produto para uso doméstico**

### **Conselhos de uso:**

- \* Coloque o produto sobre um solo plano e estável.
- \* Mantenha-o afastado de fontes de calor e chamas.
- \* Evite a sobre carga das fixações do produto.

### **Precauções antes da montagem:**

- \* Prepare a zona de montagem. Certifique-se de que esteja limpa e seca.
- \* Certifique-se que o produto esteja em bom estado.
- \* Verifique que não falte nenhuma das peças.

### **Manutenção:**

- \* Limpar o produto com a ajuda de um pano suave.
- \* Inspeccionar o produto de forma regular a fim de detectar possíveis defeitos que possa afetar seu uso.

### **Condições de armazenamento:**

- \* A fim de evitar a aparecimento de mofo, os tecidos se devem guardar totalmente secos e em um lugar limpo e sem umidade.

### **Atenção:**

**Risco de cortes durante a montagem. O fabricante declina toda responsabilidade no caso de deterioração devido uma má instalação ou por causas meteorológicas.**

**Se o produto estiver equipado com algum mecanismo elétrico de ajuste de altura ou similar, somente poderá ser substituído ou reparado por uma pessoa qualificada ou técnicos.**

# **WICHTIG! SORGFÄLTIG LESEN UND ZUM SPÄTEREN NACHSCHLAGEN AUFBEWAHREN.**

## **Ausschließlich für den häuslichen Gebrauch bestimmt Nutzungshinweise:**

- \*Bitte stellen Sie den Stuhl stabil auf eine ebene Fläche.
- \*Von offenen Feuerquellen fernhalten.
- \*Vermeiden Sie eine Überlastung des Stuhls.

## **Vorsichtsmaßnahmen vor der Montage:**

- \*Bitte bereiten Sie einen sauberen und trockenen Montagebereich vor.
- \*Stellen Sie sicher, dass das Produkt nicht beschädigt ist.
- \*Vergewissern Sie sich, dass kein Zubehörteil fehlt.

## **Instandhaltung:**

- \*Bitte reinigen Sie den Stuhl nur mit einem weichen Tuch.
- \*Überprüfen Sie den Stuhl regelmäßig.

## **Lagerung:**

- \*Der Stoff sollte an einem völlig trockenen und sauberen Ort aufbewahrt werden, um Schimmel zu vermeiden.

## **Vorsicht vor Quetsch- und Schnittgefahr bei der Montage.**

**Der Hersteller lehnt jegliche Haftung für Schäden ab, die aufgrund unsachgemäßer Montage oder Witterungseinflüsse verursacht werden. Falls der Stuhl mit einer elektronischen Höhenverstellung geliefert wird, dürfen Reparaturarbeiten nur von qualifiziertem Personal durchgeführt werden.**

# **IMPORTANTE! CONSERVARE IL PRESENTE MANUALE PER FUTURO RIFERIMENTO E LEGGERLO ATTENTAMENTE.**

## **Solo per uso domestico**

### **Istruzioni per l'uso:**

- \*Posizionare la sedia in maniera stabile su un pavimento in piano.
- \*Tenere lontano dalle fiamme vive.
- \*Evitare di sovraccaricare la sedia.

### **Precauzioni prima del montaggio:**

- \*Preparare un'area di montaggio sgombra e asciutta.
- \*Verificare che il prodotto non sia danneggiato.
- \*Verificare che non manchi nessun pezzo.

### **Manutenzione:**

- \*Pulire con un tessuto morbido.
- \*Controllare regolarmente il sedile.

### **Condizioni di stoccaggio:**

- \*Il tessuto deve essere conservato completamente asciutto, in un luogo pulito e asciutto per evitare la formazione di muffa.

**Fare attenzione al rischio di schiacciamento e di taglio durante le fasi di montaggio.**

**Il produttore declina ogni responsabilità in caso di danni dovuti ad un'installazione incorretta o alle intemperie.**

**Se la sedia è dotata di un'unità di regolazione elettrica dell'altezza del sedile, solo il personale qualificato può sostituire o riparare questi componenti elettrici.**

**PARTS**

**1** x 1



**2** x 1



**3** x 1



**4** x 1

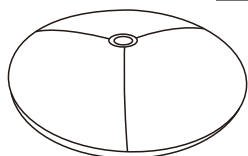

**5** x 1

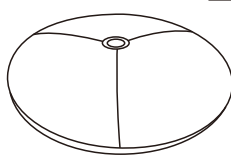

**6** x 1

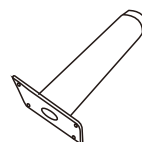

**7** x 1



**8** x 1



**9** x 1

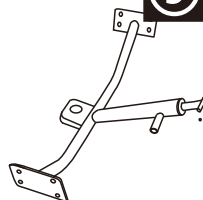

**10** x 1

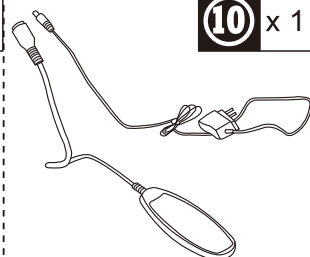

**HARDWARE**

**A** x 4  
M6\*16



**B** x 1

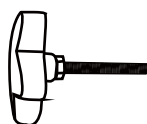

**C** x 8  
M6\*20



**D** x 3  
M8\*55

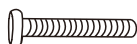

**E** x 2



**F** x 2



**G** x 1



**H** x 1



**I** x 1

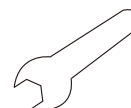



Ax4 Hx1  
M6x16mm M6

01

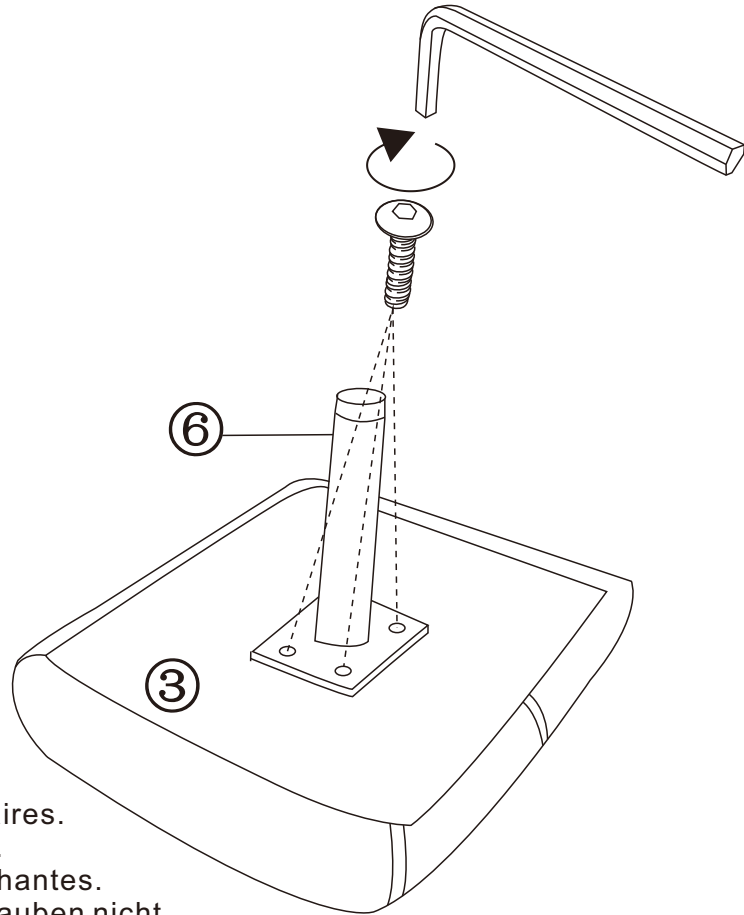

**EN**\_ Do not confuse similar screws.  
**FR**\_ Ne pas confondre des vis similaires.  
**ES**\_ No confunda tornillos similares.  
**PT**\_ Não confundir parafusos semelhantes.  
**DE**\_ Verwechseln Sie ähnliche Schrauben nicht.  
**IT**\_ Non confondere le viti simili.

02

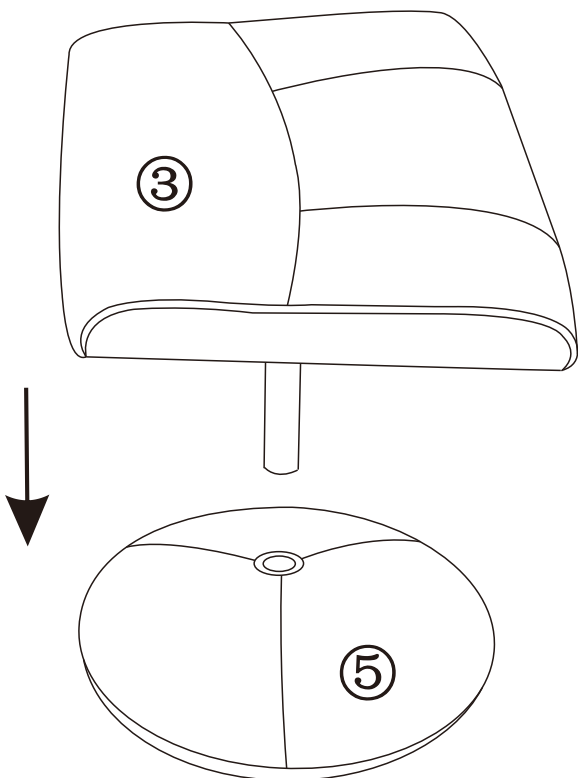

03

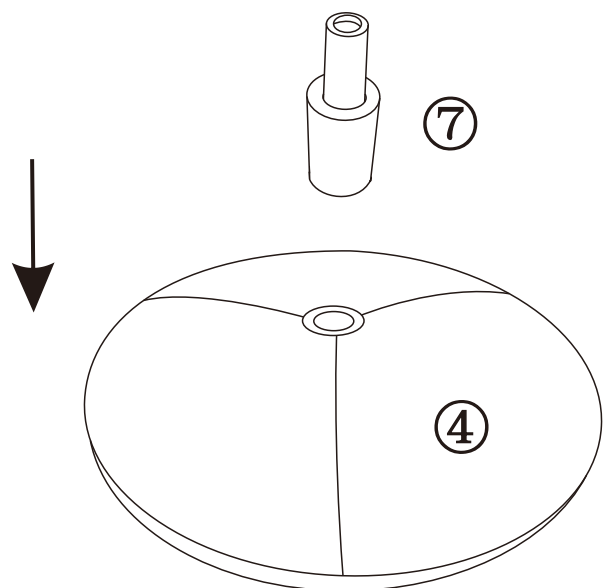

Cx4	Hx1
M6x20mm	M6

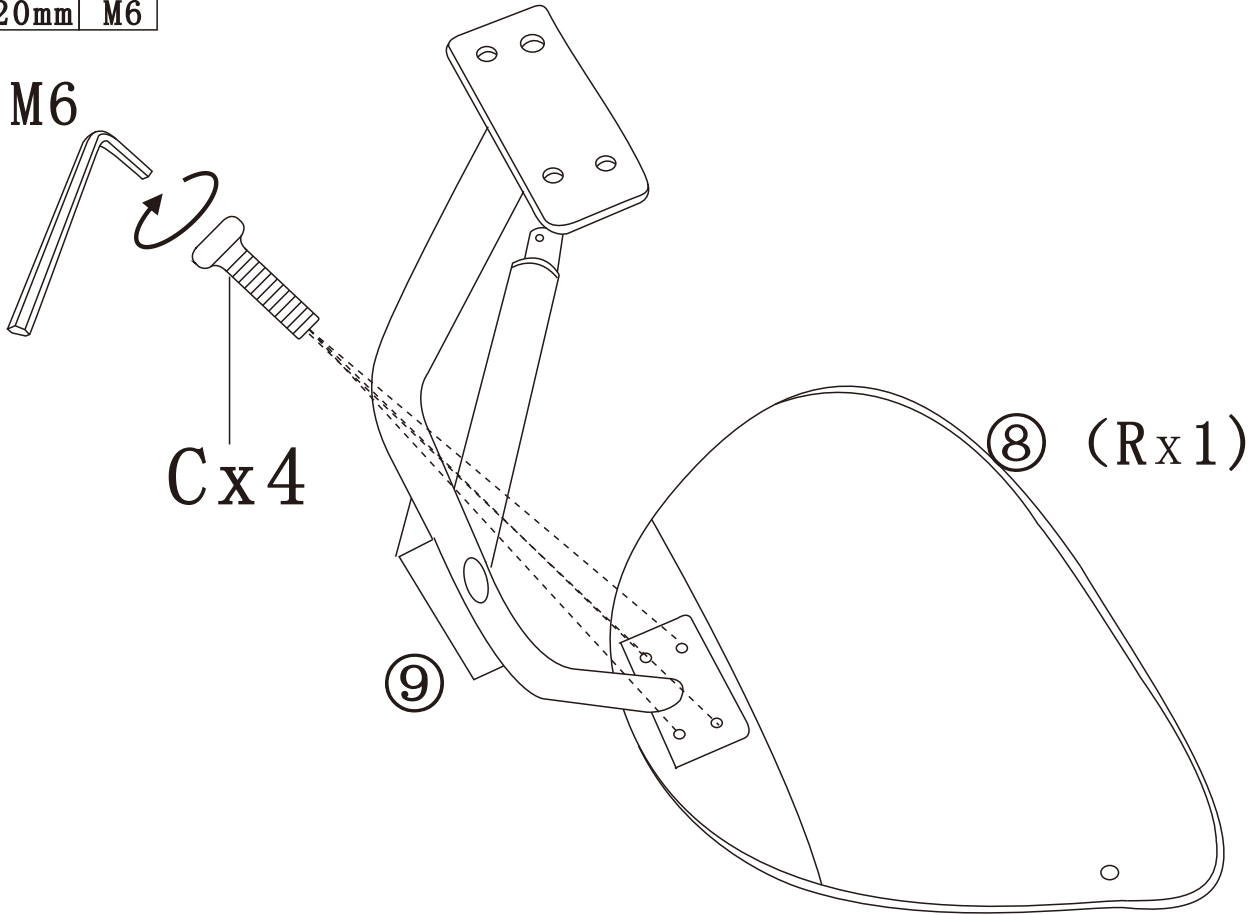

Cx4	Hx1
M6x20mm	M6

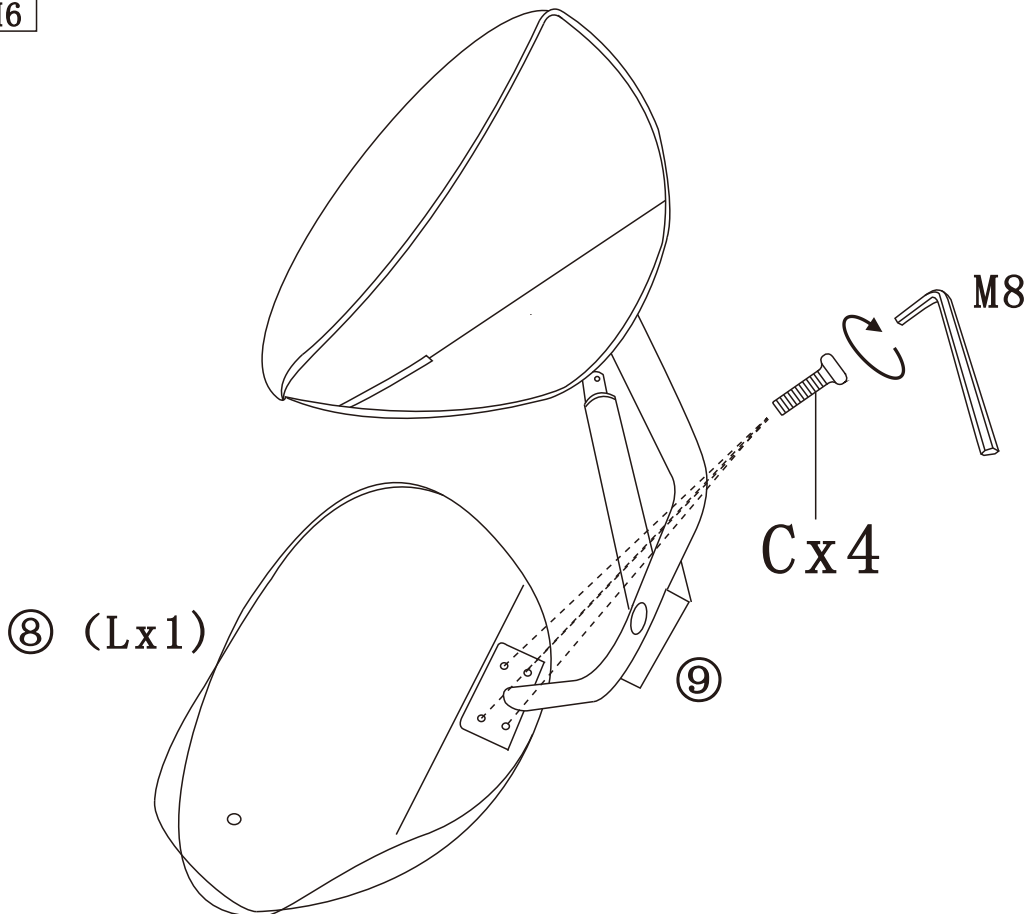

Bx1

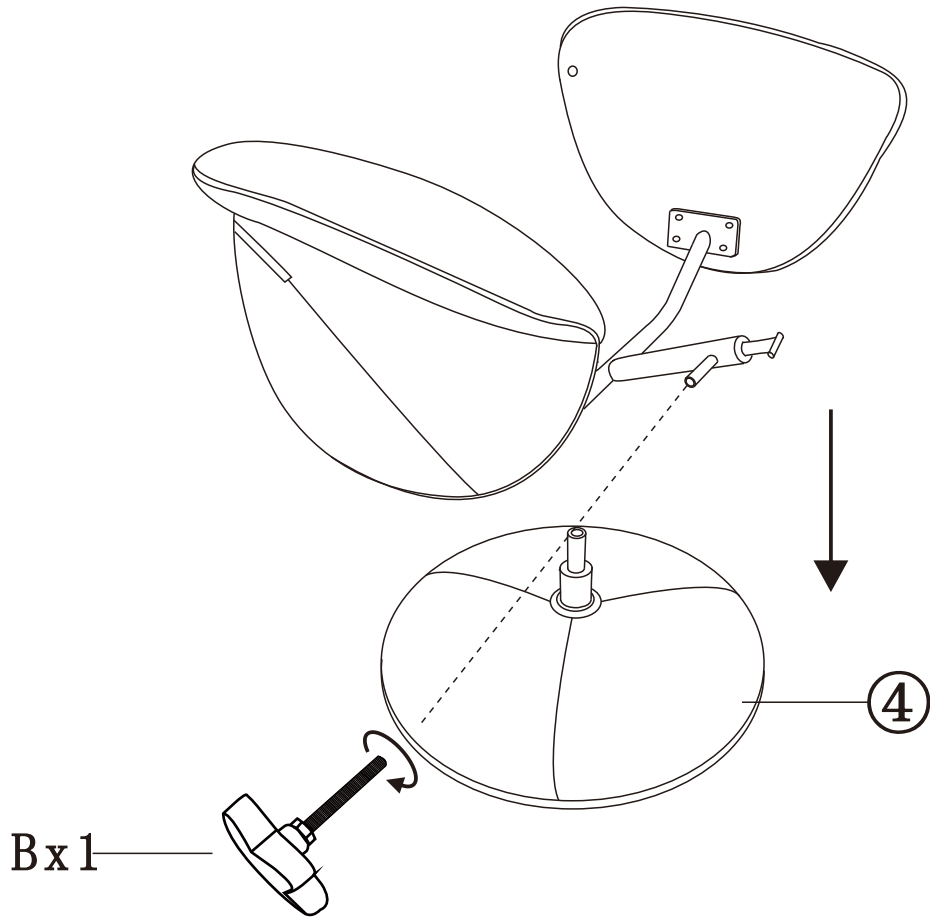

Dx1	Gx1	Hx1	Ix1
8x65mm	M8	M6	M8

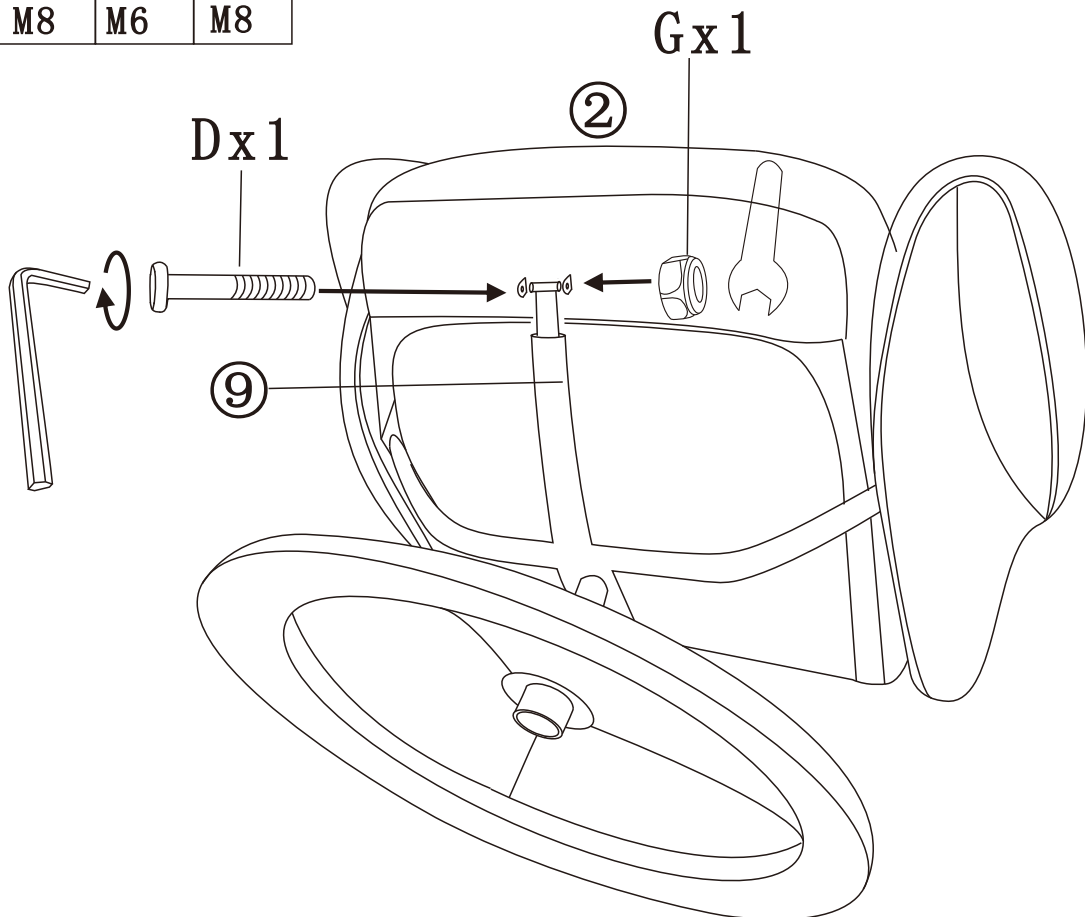

Dx2 M8x55mm	Ex2	Fx2	Hx1 M6
----------------	-----	-----	-----------

⑦x2

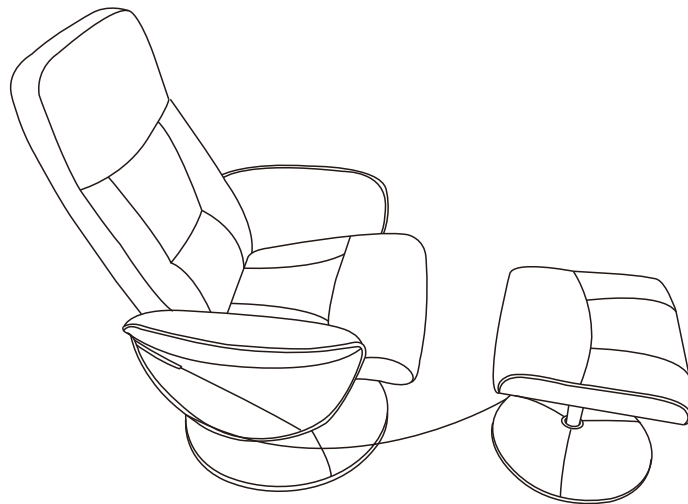
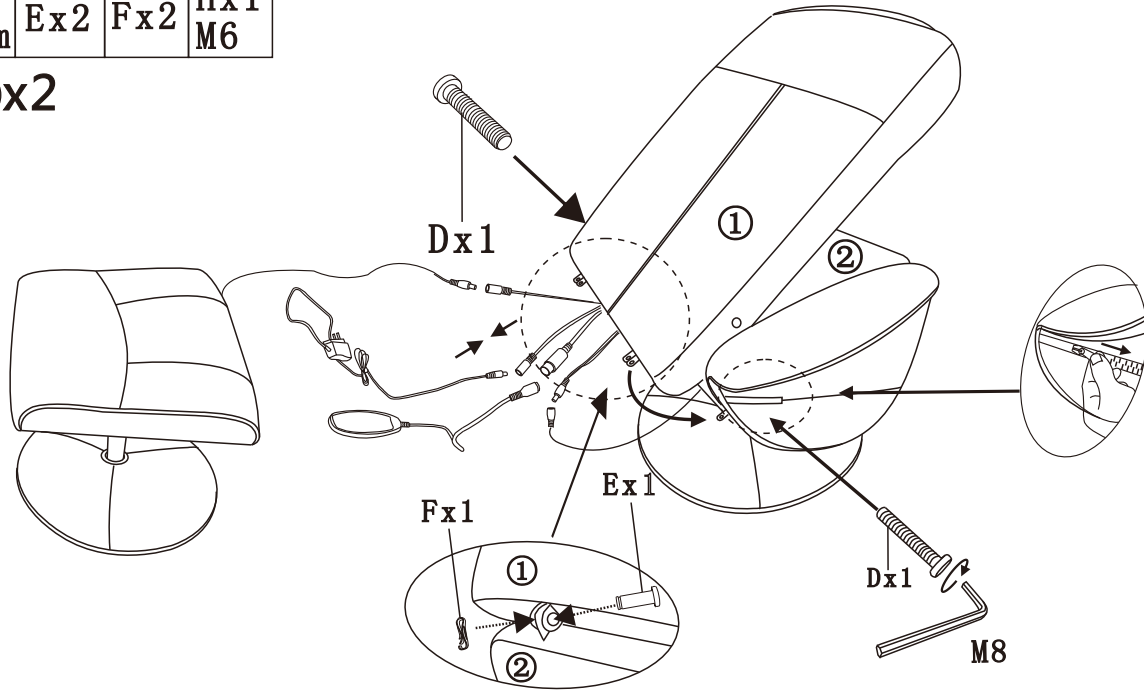

Input voltage	200-240	V
Input AC frequency	50-60	Hz
Output voltage	12	V
Output current	0.6	A
Output power	7.2	W
Average active efficiency	85	%
Efficiency at low load (10 %)	72.73	%
No-load power consumption	0.104	W

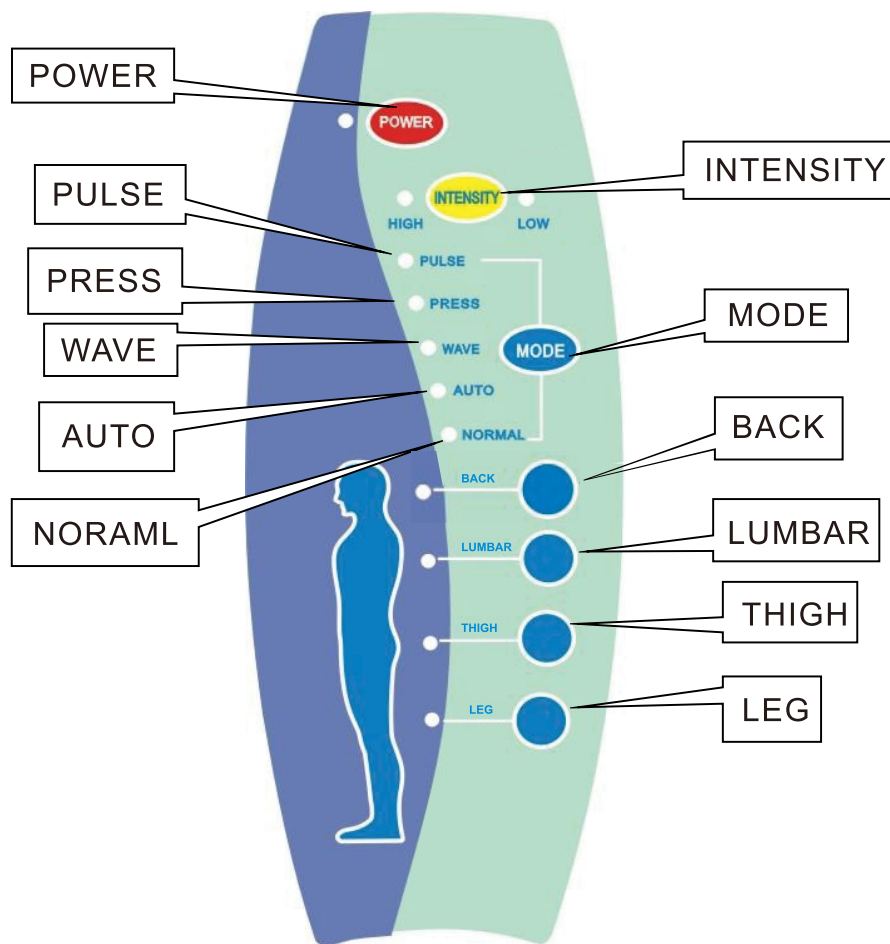

**I. Graphic presentation of Controller**

1. POWER: turn on/off selection key
2. INTENSITY: high/low selection key.
3. MODE: working mode selection key
4. BACK: back massage function selection key
5. LUMBAR: lumbar massage function selection key
6. THIGH: thigh massage function selection key
7. LEG: leg massage function selection key

**II. Operating Instructions**

1. Insert the power into the DC socket
2. Press the POWER key to start the unit
3. Press the MODE key to select different working modes(PULSE,PRESS,WAVE, AUTO,NORMAL)
4. Press the INTENSITY key to switch the intensity of vibration.
5. Press the BACK, LUMBAR ,LEG and THIGH key to massage the different places of the body

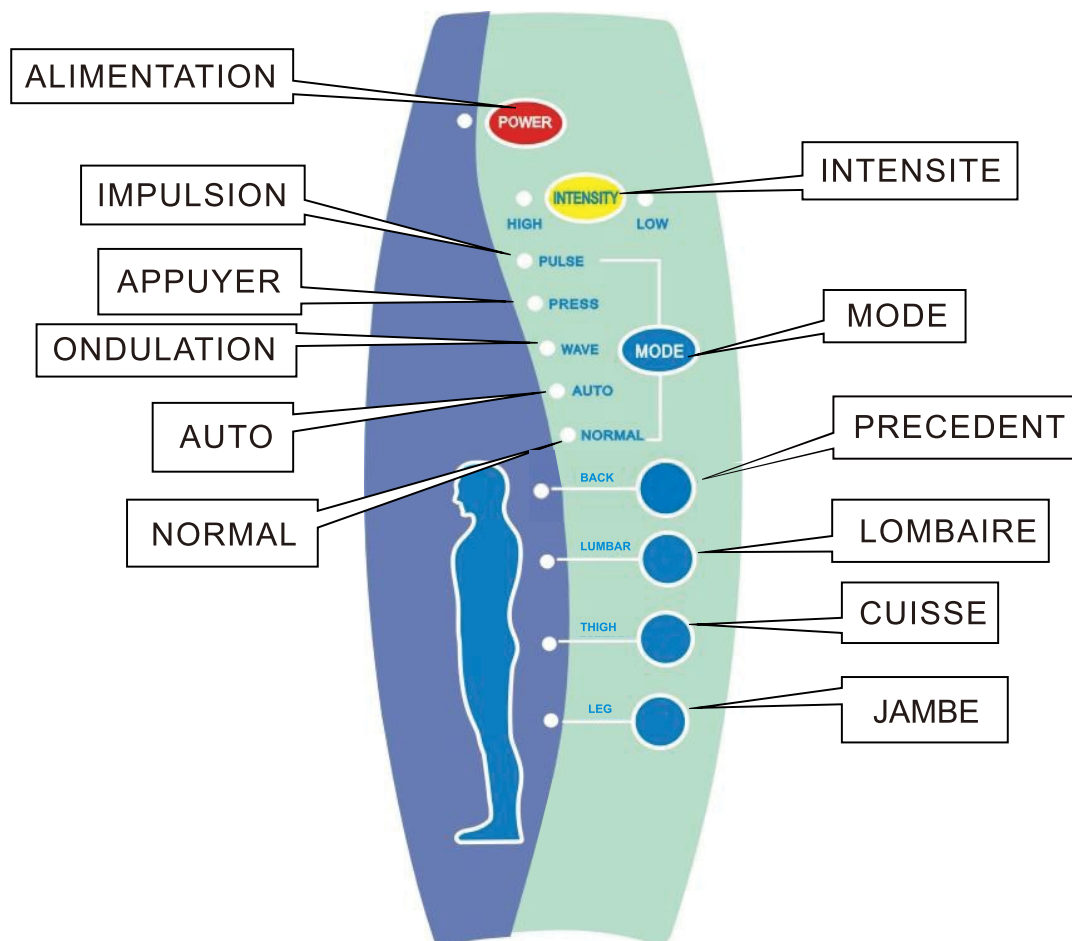

## I. Présentation graphique du contrôleur

1. ALIMENTATION : activer/désactiver la touche de sélection
2. INTENSITE : touche de sélection haut / bas
3. MODE : touche de sélection du mode de travail
4. DOS : touche de sélection de la fonction de massage du dos
5. LOMBAIRE : touche de sélection de la fonction de massage de lombaire
6. CUISSE : touche de sélection de la fonction de massage de cuisse
7. JAMBE: touche de sélection de la fonction de massage des jambes

## II. Instructions d'exploitation

1. Insérez la fiche d'alimentation dans la prise CC
2. Appuyez sur la touche ALIMENTATION pour démarrer l'appareil
3. Appuyez sur la touche MODE pour sélectionner différents modes de travail (IMPULSION, PRESSE, ONDULATION, AUTO, NORMAL)
4. Appuyez sur la touche INTENSITÉ pour changer l'intensité des vibrations.
5. Appuyez sur la touche de votre choix (DOS, LOMBAIRE, JAMBE et CUISSE) pour masser les différents endroits du corps

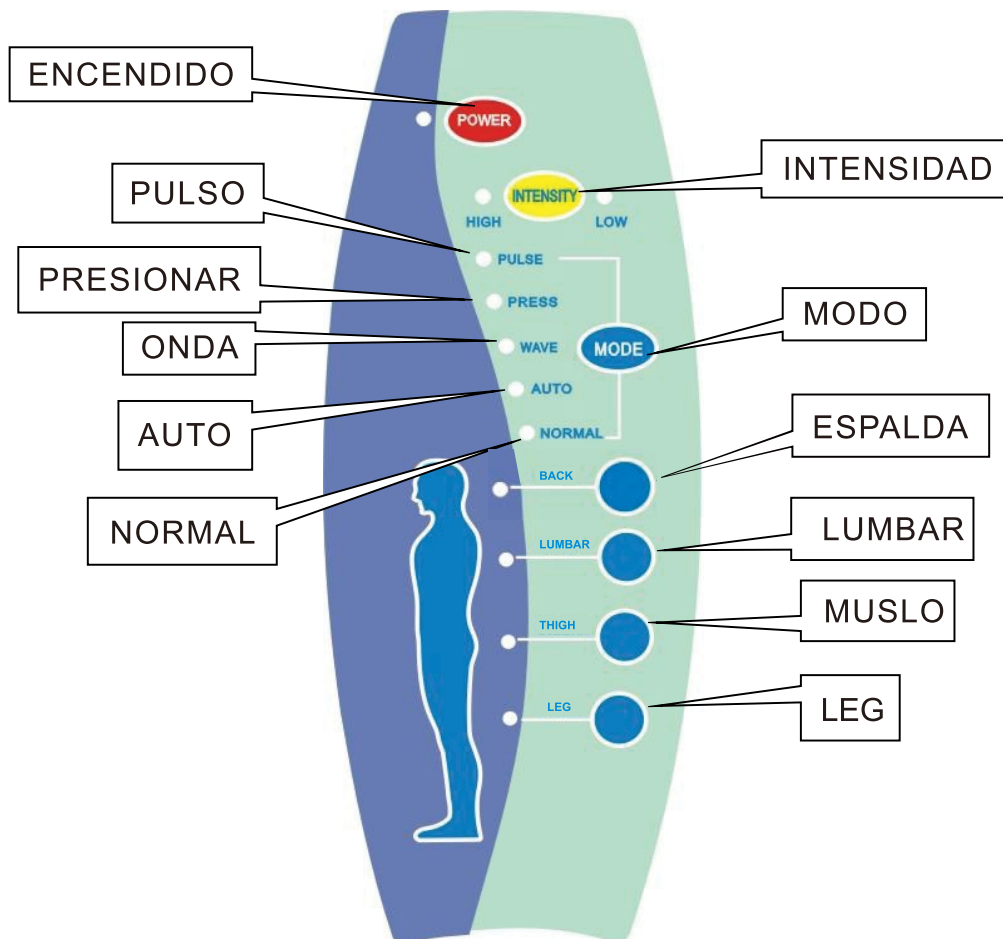

## I. Presentación gráfica del controlador

1. POWER (ENCENDIDO): Encender / apagar la tecla de selección
2. INTENSIDAD: Tecla para seleccionar la intensidad alta/baja
3. MODO: Tecla para seleccionar el modo de masaje
4. ESPALDA: Tecla para seleccionar la función de masaje de espalda
5. LUMBAR: Tecla para seleccionar la función de masaje de lumbar
6. MUSLO: Tecla para seleccionar la función de masaje de muslo
7. LEG: tecla de selección de función de masaje de piernas

## II. Instrucciones de operación

1. Conecte la corriente a la toma de CC
2. Presione la tecla POWER (ENCENDIDO) para iniciar el masajeador
3. Presione la tecla MODO para seleccionar diferentes modos de trabajo (PULSO, PRESIONAR, ONDA, AUTO, NORMAL).
4. Presione la tecla INTENSITY (INTENSIDAD) para seleccionar la intensidad de vibración
5. Presione la tecla BACK, LUMBAR y THIGH (ESPALDA, LUMBAR, LEG y MUSLO) para masajear los diferentes lugares del cuerpo.

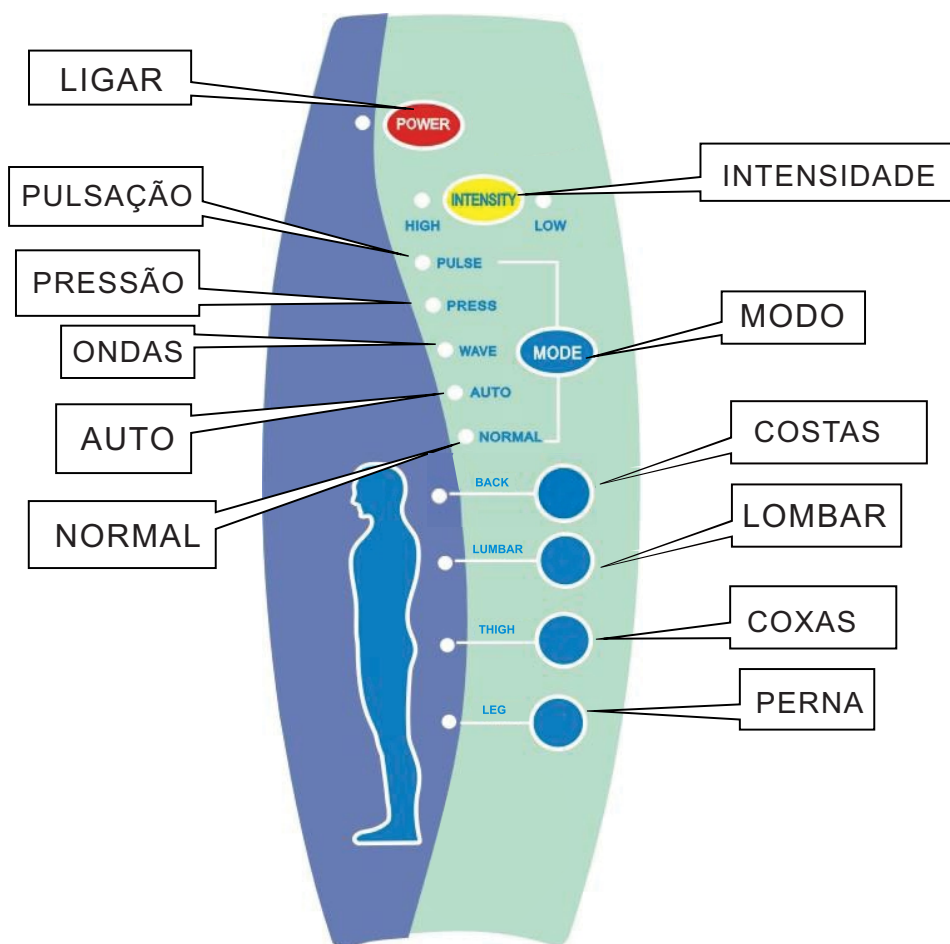

### I. Apresentação gráfica do controlo

1. LIGAR/DESLIGAR: tecla de seleção para ligar/desligar
2. INTENSIDADE: tecla de seleção forte/fraco.
3. MODO: tecla de seleção do modo de trabalho
4. COSTAS: tecla de seleção da função de massagem nas costas
5. LOMBAR: tecla de seleção da função de massagem lombar
6. COXAS: tecla de seleção da função de massagem das coxas
7. LEG: tecla de seleção da função de massagem das pernas

### II. Instruções de funcionamento

1. Introduzir a alimentação na tomada de corrente contínua
2. Premir a tecla LIGAR/DESLIGAR para iniciar a unidade.
3. Prima a tecla FUNÇÃO para selecionar os diferentes modos de funcionamento (PULSAÇÃO, PRESSÃO, ONDA, AUTO, NORMAL)
4. Premir a tecla INTENSIDADE para selecionar a intensidade de vibração alta e baixa.
5. Premir a tecla COSTAS, LÚMBAR, COXA e PERNA para massajar os diferentes pontos do corpo



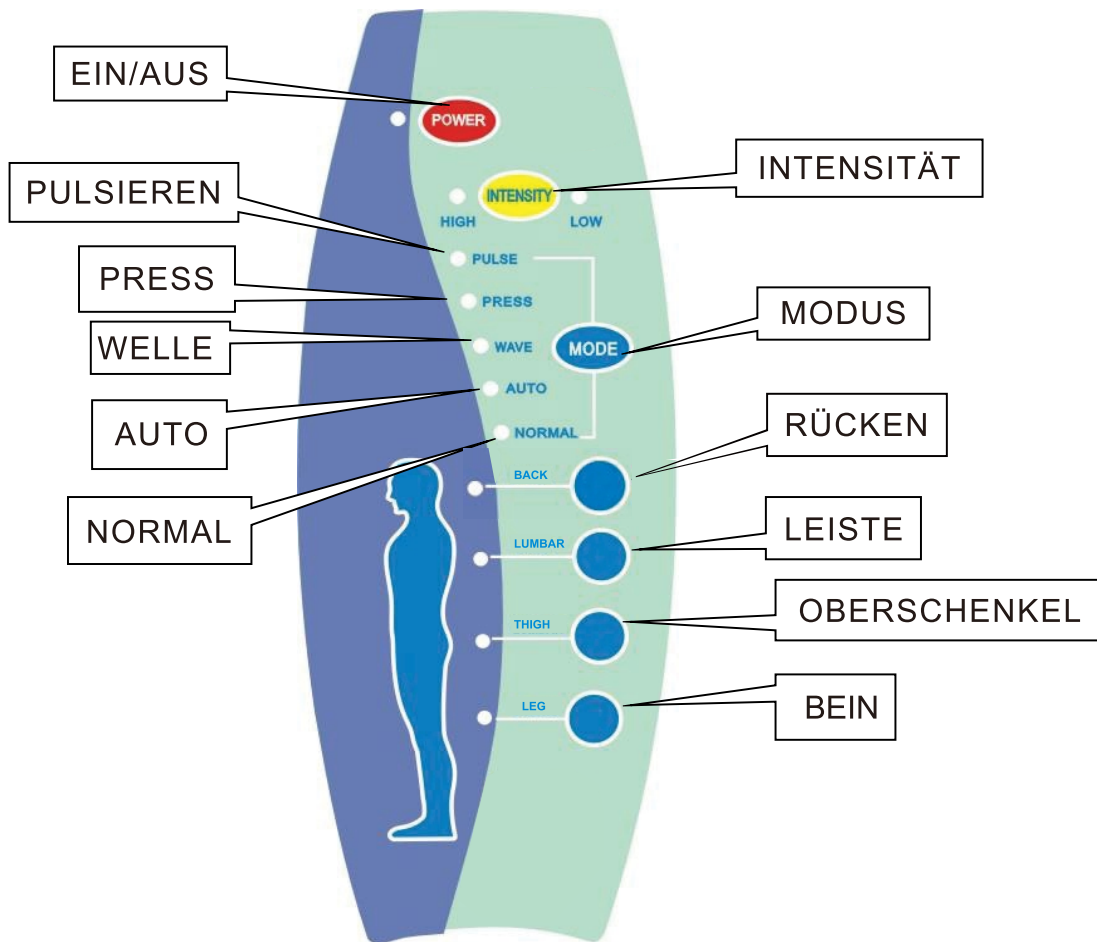

## I. Grafische Darstellung der Fernbedienung

1. EIN/AUS: Ein-/Ausschalten
2. INTENSITÄT: hoch/niedrig Auswahltaste.
3. MODUS: Arbeitsmodus-Auswahltaste
4. ZURÜCK: Funktionswahltaste Rückenmassage
5. LUMBAR: Funktionsauswahltaste für die Lumbalmassage
6. THIGH: Oberschenkelmassage-Funktionswahltaste
7. BEIN: Auswahltaste für die Beinmassagefunktion

## II. Bedienungsanleitung

1. Stecken Sie den Netzstecker in die DC-Buchse
2. Drücken Sie die Ein/Aus-Taste, um das Gerät zu starten
3. Drücken Sie die MODUS, um verschiedene Arbeitsmodi zu wählen (PULS, DRÜCKEN, WELLE, AUTO, NORMAL)
4. Drücken Sie die Taste INTENSITÄT, um die Vibrationsintensität auszuwählen.
5. Drücken Sie die Tasten RÜCKEN, LEISTE, BEIN und OBERSCHENKEL, um die verschiedenen Stellen des Körpers zu massieren

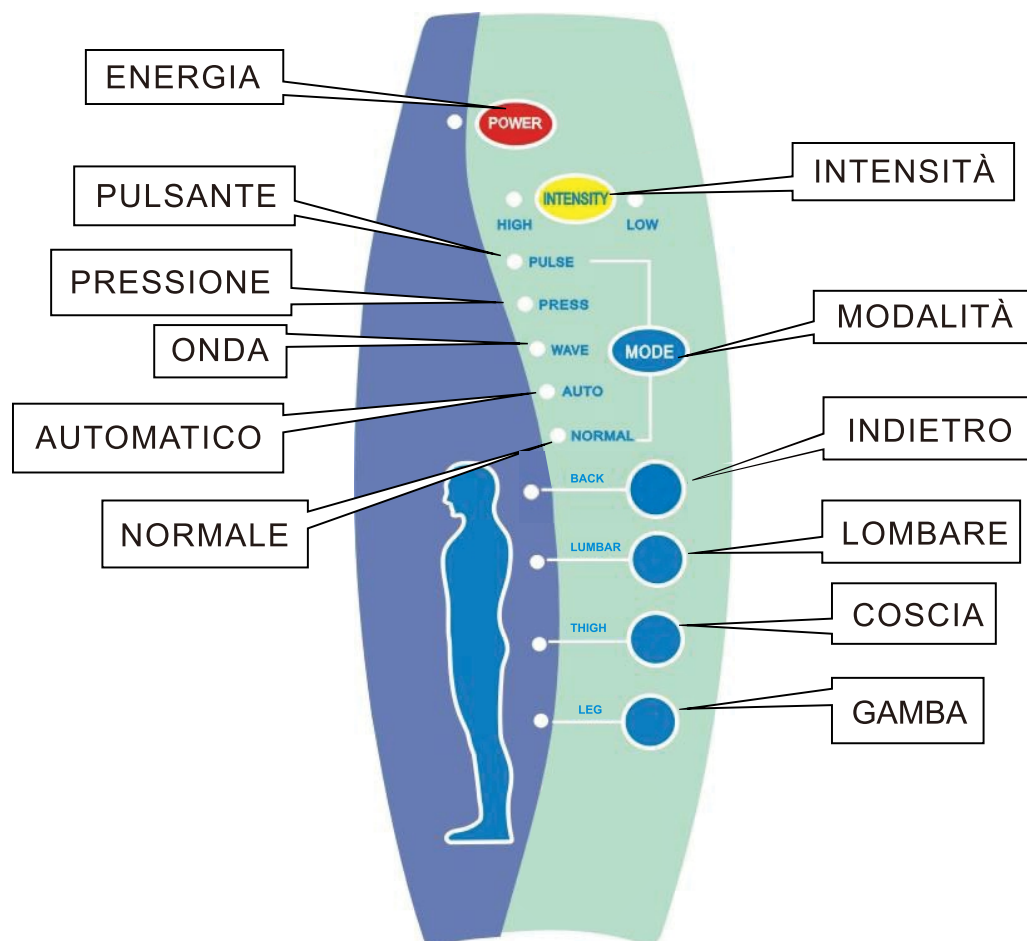

### I. Rappresentazione grafica del telecomando

1. ENERGIA: pulsante per accendere/spegnere il prodotto
2. INTENSITÀ: pulsante per massaggio alto/basso
3. MODALITÀ: pulsante di selezione modalita'
4. INDIETRO: seleziona il massaggio alla schiena
5. LOMBARE: seleziona il massaggio alla zona lombare
6. COSCIA: seleziona il massaggio alle cosce
7. GAMBA: tasto di selezione della funzione di massaggio delle gambe

### II. Istruzioni d'uso

1. Inserire il cavo di alimentazione nella presa
2. Premete il pulsante ENERGIA per accendere il dispositivo
3. Premere il pulsante MODALITÀ per selezionare diverse modalita' di funzionamento (PULSANTE, PRESSIONE, ONDA, AUTOMATICO, NORMALE)
4. Premere il pulsante INTENSITÀ per impostare l'intensita' della vibrazione.
5. Premere i pulsanti INDIETRO, LOMBARE, GAMBA e COSCIA per massaggiare le diverse parti del corpo.

If you have any questions, please contact our customer care center.

Our contact details are below:

 001-877-644-9366

 customerservice@aosom.com

Imported by Aosom LLC

27150 SW Kinsman Rd Wilsonville, OR 97070 USA

MADE IN CHINA

**US**

Si tiene alguna pregunta, comuníquese con nuestro Centro de Atención al Cliente.

Nuestros datos de contacto son los siguientes:

 0034-931294512

 atencioncliente@aosom.es

IMPORTADOR:

SPANISH AOSOM, S.L.

C/ ROC GROS, Nº 15. 08550, ELS HOSTALETES DE BALENYÀ, SPAIN.

B66295775

WWW.AOSOM.ES

HECHO EN CHINA

**ES**

If you have any questions, please contact our customer care center.

Our contact details are below:

 416-792-6088

 customerservice@aosom.ca

Imported by Aosom Canada Inc.

7270 Woodbine Avenue, Unit 307, Markham,

Ontario Canada L3R 4B9

MADE IN CHINA

**CA**

Se tiver alguma dúvida, por favor contacte o nosso Centro de Atendimento ao Cliente.

Os nossos dados de contacto são os seguintes:

 0034-931294512 (SEG-SEX DAS 7:30H ÀS 16:30H)

 info@aosom.pt.

IMPORTADOR:

SPANISH AOSOM, S.L

C.ROC GROS N.15, 08550. ELS HOSTALETES DE BALENYÀ

WWW.AOSOM.PT

**PT**

Si vous avez la moindre question, veuillez contacter notre centre d'assistance à la clientèle.

Nos coordonnées sont les suivantes:

 416-792-6088

 customerservice@aosom.ca

Importé par Aosom Canada Inc.

7270 Woodbine Avenue, unité 307,

Markham, Ontario Canada L3R 4B9

Fabriqué en Chine

**DE**

Wenn Sie Fragen haben, wenden Sie sich bitte an unser Kundendienstzentrum.

Unsere Kontaktdaten stehen unten:

 0049-0(40)-88307530  service@aosom.de

ADRESSE DES IMPORTEURS:

MH Handel GmbH

Wendenstraße 309

D-20537 Hamburg

Germany

IN CHINA HERGESTELLT

**IT**

In caso di dubbio, si prega di contattare il nostro centro assistenza clienti.

I nostri dettagli di contatto sono di seguito:

 0039-0249471447  clienti@aosom.it

IMPORTATO DA:

AOSOM Italy srl

Centro Direzionale Milanofiori

Strada 1 Palazzo F1

20057 Assago (MI)

P.I.: 08567220960

FATTO IN CINA

If you have any questions, please contact our customer care center.

Our contact details are below:

 0044-800-240-4004

 enquiries@mhstar.co.uk

IMPORTER ADDRESS:

MH STAR UK LTD

Unit 27, Perivale Park,

Horsenden lane South

Perivale, UB6 7RH

MADE IN CHINA

**UK**

Si vous avez la moindre question, veuillez contacter notre centre d'assistance à la clientèle.

Nos coordonnées sont les suivantes:  0033-1-84166106  aosom@mhfrance.fr

Importé par: MH France 2, rue Maurice Hartmann 92130 Issy-les-Moulineaux

Fabriqué en Chine

France

**FR**



FR

**DONNEZ  
OU  
RECYCLEZ**



OU



OU



ASSOCIATION LIVRAISON DÉCHÈTERIE

Adresses sur [quefairedemesdechets.fr](http://quefairedemesdechets.fr)