

# Vinsetto

IN230600551V01\_GL

**924-070V00**

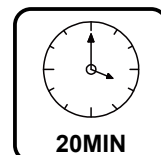
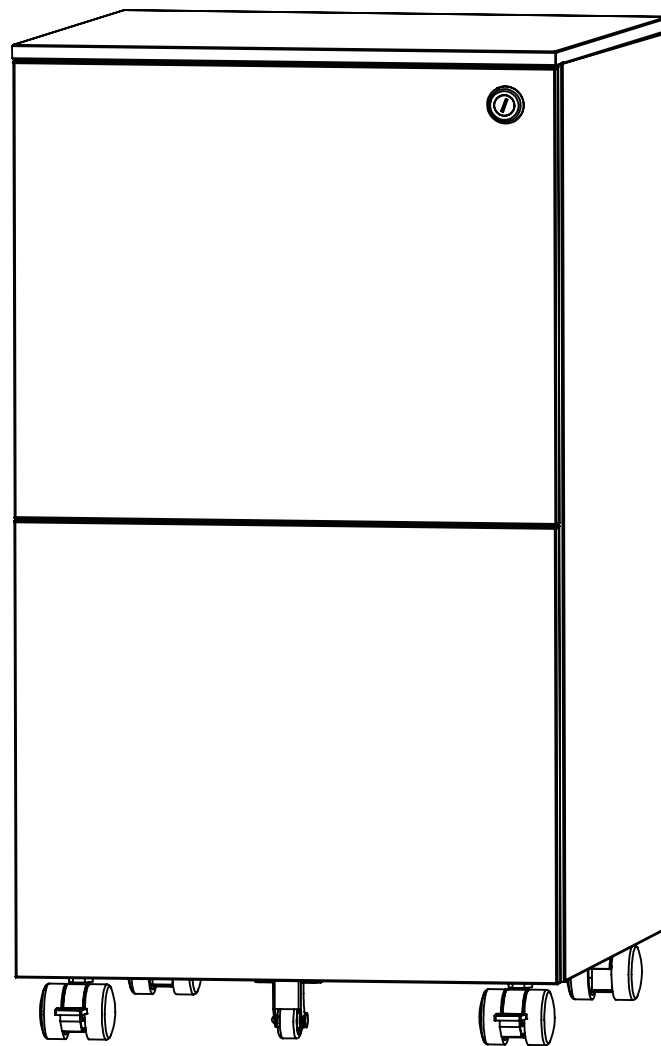

EN\_ IMPORTANT, RETAIN FOR FUTURE REFERENCE: READ CAREFULLY.

FR\_ IMPORTANT : A LIRE ATTENTIVEMENT ET À CONSERVER POUR CONSULTATION ULTÉRIEURE.

ES\_ IMPORTANTE, LEA DETENIDAMENTE Y GUARDE PARA FUTURAS REFERENCIAS.

PT\_ IMPORTANTE, GARDE PARA FUTURA REFERÊNCIA, LEIA ATENTAMENTE.

DE\_ WICHTIG! SORGFÄLTIG LESEN UND FÜR SPÄTER NACHSCHLAGEN AUFBEWAHREN.

IT\_ IMPORTANTE, LEGGERE E CONSERVARE QUESTO MANUALE D'ISTRUZIONE PER UN USO FUTURO.

**EN**

**Dear customer,**

Thank you for purchasing this product. So that your appliance serves you well, please read all the instructions in this user's manual. If you have any questions, please contact our customer care center, Our contact details are below:

**FR**

**Cher client,**

Nous vous remercions d'avoir acheté ce produit. Afin que vous puissiez profiter pleinement de votre appareil, veuillez lire toutes les instructions de ce manuel d'utilisation. Si vous avez la moindre question, veuillez contacter notre centre d'assistance à la clientèle, Nos coordonnées sont les suivantes:

**DE**

**Sehr geehrter Kunde,**

Vielen Dank, dass Sie dieses Produkt erworben haben. Damit Ihr Gerät Ihnen gute Dienste leistet, lesen Sie bitte alle Hinweise in diesem Benutzerhandbuch. Wenn Sie Fragen haben, wenden Sie sich bitte an unser Kundendienstzentrum, Unsere Kontaktdaten stehen unten:

**ES**

**Queridos clientes,**

Gracias por comprar este producto. Para que su electrodoméstico le sirva mejor, lea todas las instrucciones de este manual del usuario. Si tiene alguna pregunta, comuníquese con nuestro Centro de Atención al Cliente, Nuestros datos de contacto son los siguientes:

**PT**



**Caros clientes,**

Obrigado por adquirir este produto. Para que o seu aparelho o sirva melhor, leia todas as instruções deste manual do utilizador. Se tiver alguma dúvida, por favor contacte o nosso Centro de Atendimento ao Cliente, Os nossos dados de contacto são os seguintes:







**IT**

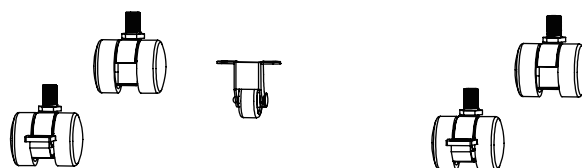
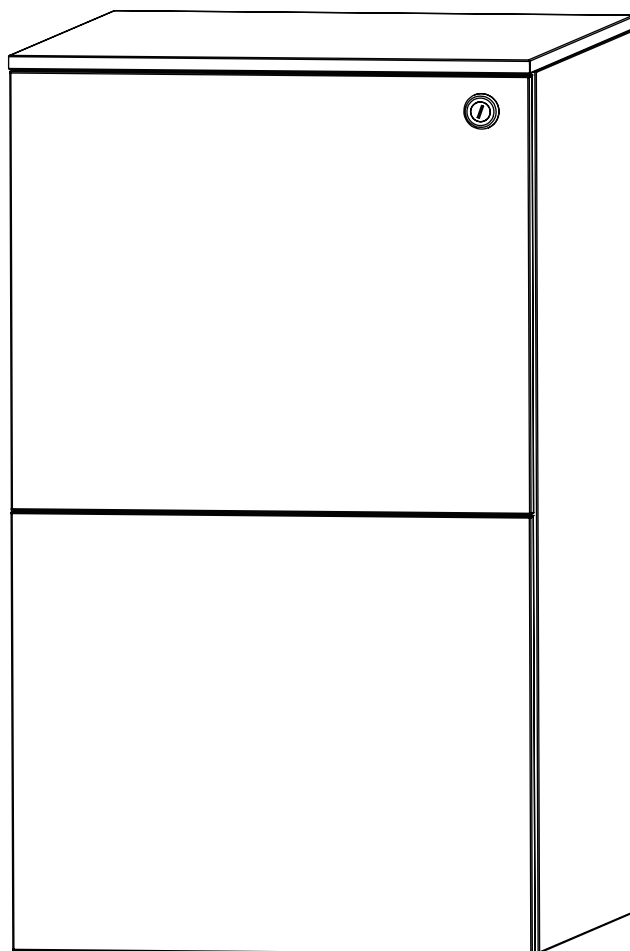

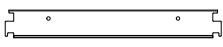

**Caro Cliente,**

Grazie per aver acquistato questo prodotto. Per servirti meglio con questo apparecchio ti prego di leggere tutte le istruzioni in presente manuale utente. In caso di dubbio, si prega di contattare il nostro centro assistenza clienti, I nostri dettagli di contatto sono di seguito:



Country	 Phone	 Email
US	001-877-644-9366	customerservice@aosom.com
CA	416-792-6088	customerservice@aosom.ca
UK	0044-800-240-4004	enquiries@mhstar.co.uk
DE	0049-0(40)-88307530	service@aosom.de
FR	0033-1-84166106	aosom@mhfrance.fr
ES	0034-931294512	atencioncliente@aosom.es
PT	0034-931294512	info@aosom.pt
IT	0039-0249471447	clienti@aosom.it

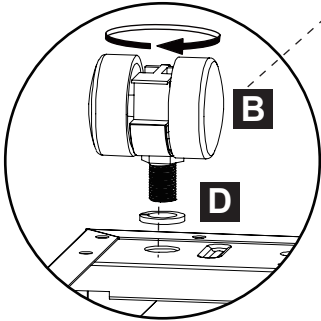
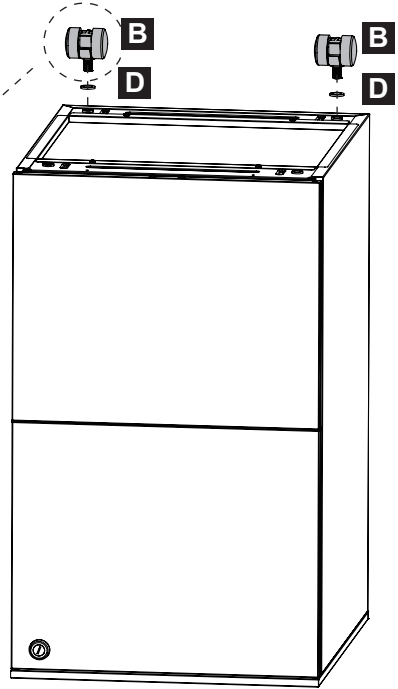
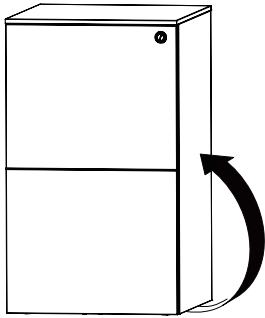

 <b>A</b> X2	 <b>B</b> X2	 <b>C</b> X1	 <b>D</b> X4
 <b>E</b> X2	 <b>G</b> X2	 <b>H</b> X1	 <b>I</b> X1

 <b>A</b> X2	 <b>B</b> X2	 <b>D</b> X4	 <b>H</b> X1
---	---	---	---



 <b>A</b>	Lockable casters
 <b>B</b>	360° Swivel Casters

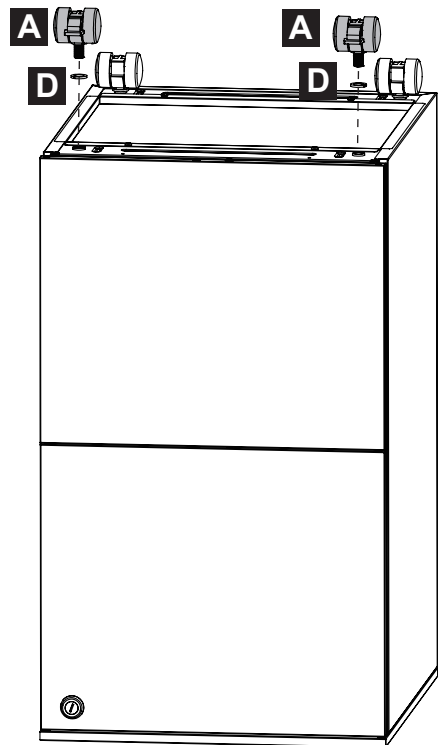

- C** X1
- E** X2
- I** X1

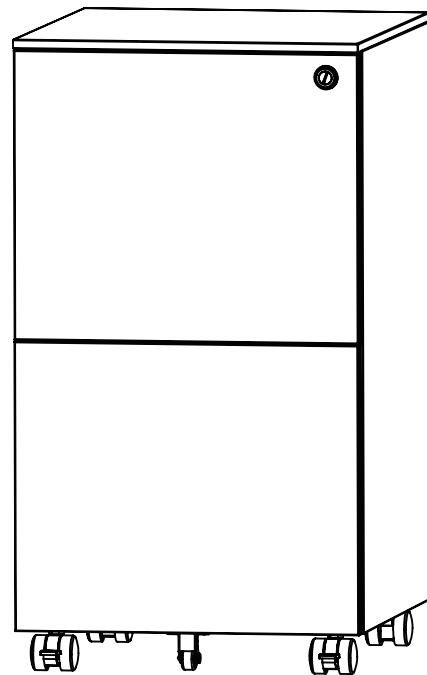
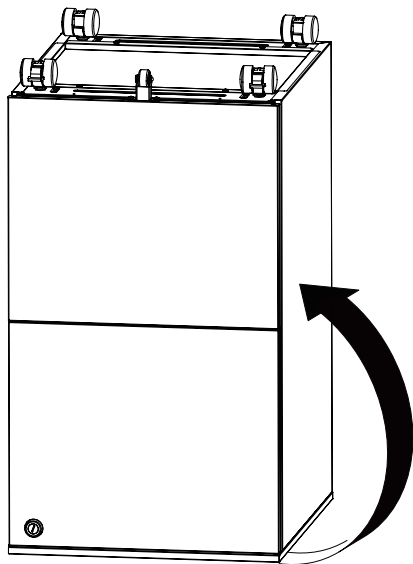
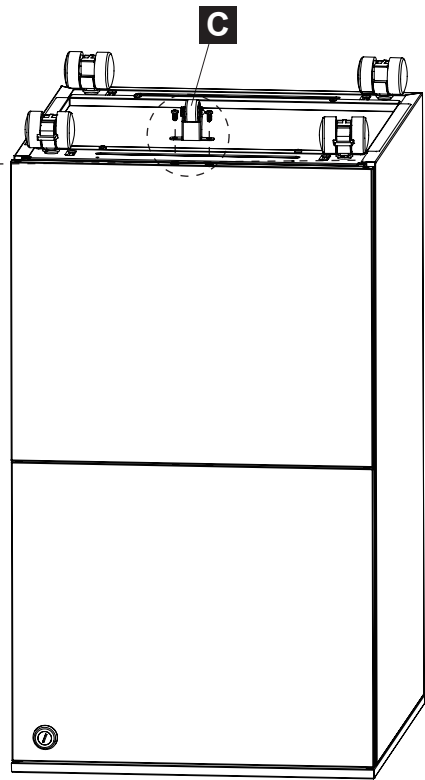
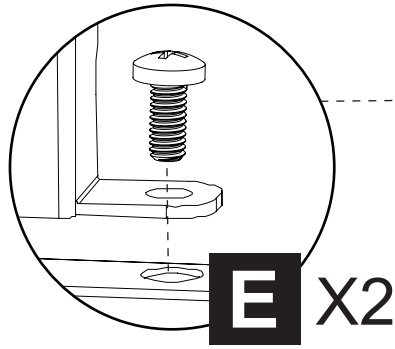

**EN:** Install or adjust the hanging file bar, please follow the below method.

**FR:** Pour installer ou ajuster le rail des dossiers suspendus, veuillez suivre la méthode ci-dessous.

**ES:** Instale o ajuste la barra de archivos colgantes, siga el método a continuación.

**PT:** Para instalar ou ajustar a barra de arquivo suspensa, siga os passos abaixo.

**DE:** Installieren oder verstellen Sie die Hängeregisterstange wie unten beschrieben.

**IT:** Installare o regolare la barra di supporto dei cavi, secondo il metodo seguente.

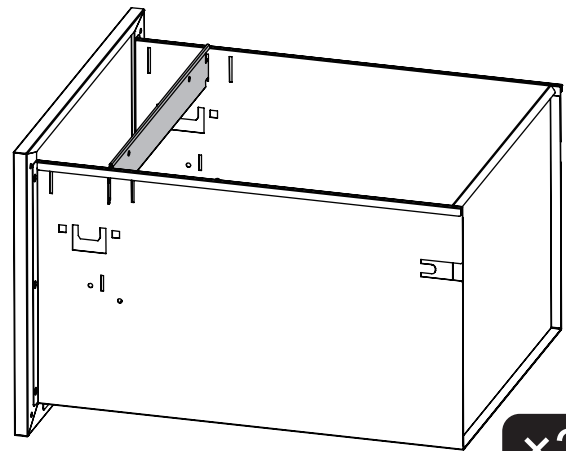
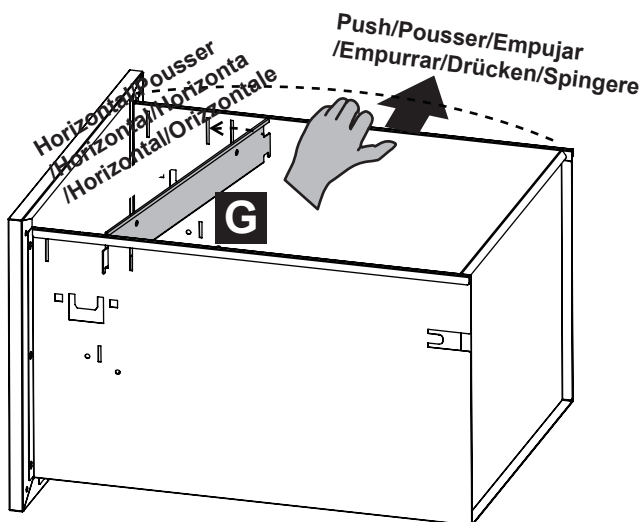
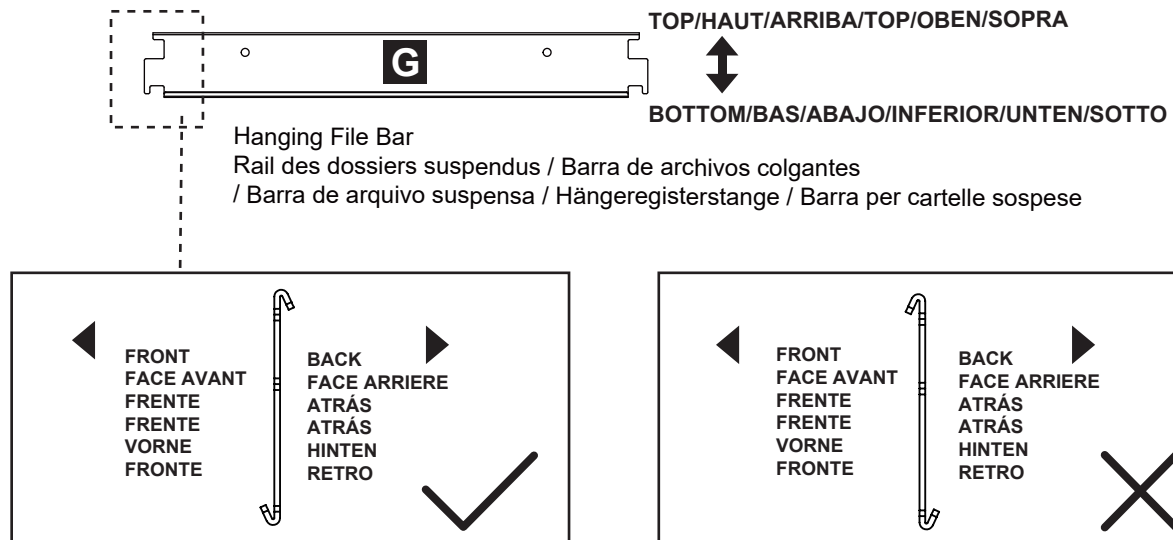

**EN:** Please do not vertically install the hanging file bar, especially in the front or back of the filing drawer, otherwise it will be difficult to install.

**FR:** Veuillez ne pas installer verticalement le rail des dossiers suspendus, surtout à l'avant ou à l'arrière du tiroir de classement, sinon il sera difficile de l'installer.

**ES:** No instale verticalmente la barra de archivo colgante, especialmente en la parte delantera o trasera del cajón de archivo, de lo contrario será difícil de instalar.

**PT:** Não instale verticalmente a barra de arquivo suspensa, especialmente na parte da frente ou de trás da gaveta de arquivo, caso contrário será difícil de instalar.

**DE:** Bitte bringen Sie die Hängeregisterstange nicht vertikal an, insbesondere nicht an der Vorder- oder Rückseite der Schublade, da sie sonst nur schwer zu installieren ist.

**IT:** Si prega di non installare verticalmente la barra per cartelle sospese, specialmente nella parte anteriore o posteriore del cassetto di archiviazione, altrimenti sarà difficile installarla.

**Vertical/Vertikal/Verticale**

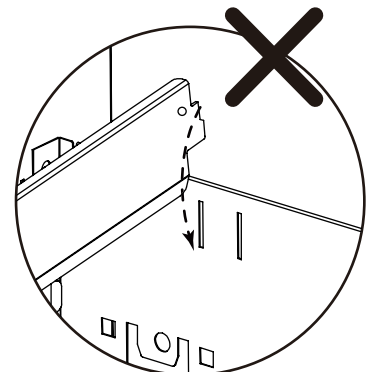

**EN:** Adjust the position of **G** Part for letter, A4, legal size files.

**FR:** Ajustez la hauteur de la pièce **G** en fonction du format des dossiers (lettre, A4, légal).

**ES:** Ajuste la posición de la parte **G** para archivos de tamaño carta, A4 y legal.

**PT:** Ajustar a posição da Parte **G** para ficheiros de tamanho carta, A4 e normal.

**DE:** Verstellen Sie die Position von Teil **G** für Ordner der Formate Letter, A4 und Legal.

**IT:** Regolare la posizione della parte **G** per i formati Legale, A4 e Lettera.

1.

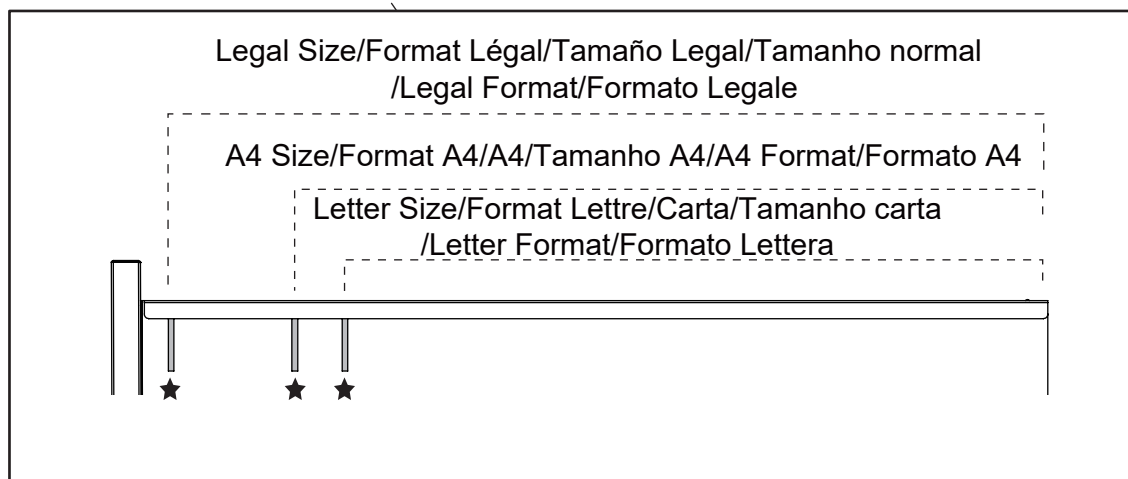
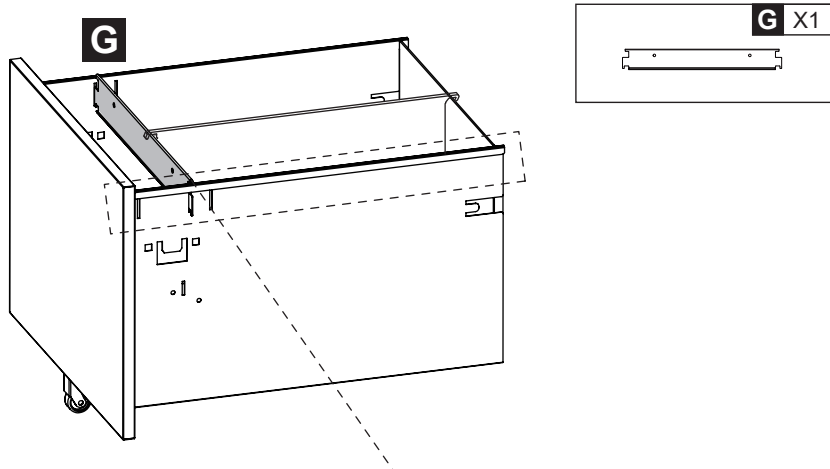

2.

**EN:** One filing drawer support A4, legal, letter size file folders

**FR:** Un tiroir de classement permet de ranger des dossiers de format A4, légal ou lettre.

**ES:** Un cajón archivador para carpetas de tamaño A4, legal y carta

**PT:** Uma gaveta de arquivo para pastas de arquivo de tamanho A4, normal e carta

**DE:** Eine Schublade unterstützt A4-, Legal- und Letter-Ordner

**IT:** Un cassetto di archiviazione supporta faldone per i formati Legale, A4 e lettera.

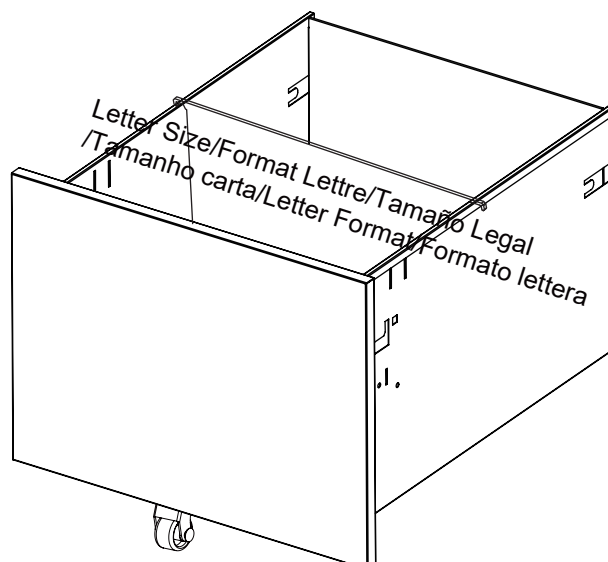

**US**

Imported by Aosom LLC  
27150 SW Kinsman Rd Wilsonville, OR 97070 USA  
MADE IN CHINA

**CA**

Imported by Aosom Canada Inc.  
7270 Woodbine Avenue, Unit 307, Markham, Ontario Canada  
L3R 4B9  
MADE IN CHINA

Importé par Aosom Canada Inc.  
7270 Woodbine Avenue, unité 307, Markham, Ontario Canada  
L3R 4B9  
Fabriqué en Chine

**UK**

IMPORTER ADDRESS:  
MH STAR UK LTD  
Unit 27, Perivale Park,  
Horsenden lane South  
Perivale, UB6 7RH  
MADE IN CHINA

**FR**

ADRESSE D'IMPORTATION:  
MH FRANCE  
2 Rue Maurice Hartmann  
92130 Issy Les Moulineaux  
France  
FABRIQUÉ EN CHINE



FR

**Pensez à  
donner ou recycler.**



Association

ou



Magasin

ou



Déchèterie

<https://quefairedemesdechets.fr>

**ES**

IMPORTADOR:  
SPANISH AOSOM, S.L.  
C/ROC GROS, Nº15.08550, ELS HOSTALETS DE BALENYÀ, SPAIN.  
B66295775  
WWW.AOSOM.ES  
ATENCIONCLIENTE@AOSOM.ES  
TEL: 931294512  
HECHO EN CHINA

**PT**

SPANISH AOSOM, S.L  
C.ROC GROS N.15, 08550. ELS HOSTALETS DE BALENYÀ  
TEL: 931294512 (SEG-SEX DAS 7:30H ÀS 16:30H)  
INFO@AOSOM.PT  
WWW.AOSOM.PT

**DE**

ADRESSE DES IMPORTEURE:  
MH Handel GmbH  
Wendenstraße 309  
D-20537 Hamburg  
Germany  
IN CHINA HERGESTELLT

**IT**

IMPORTATO DA:  
AOSOM Italy srl  
Centro Direzionale Milanofiori  
Strada 1 Palazzo F1  
20057 Assago (MI)  
P.I.: 08567220960  
FATTO IN CINA