

EN_IMPORTANT, RETAIN FOR FUTURE REFERENCE: READ CAREFULLY.

FR_IMPORTANT: A LIRE ATTENTIVEMENT ET A CONSERVER POUR VOUS Y REFRERER ULTERIEUREMENT

ES_IMPORTANTE, LEA DETENIDAMENTE Y GUARDE PARA FUTURAS REFERENCIAS.

PT_IMPORTANTE, GARDE PARA FUTURA REFERÊNCIA, LEIA ATENTAMENTE.

DE_WICHTIG! SORFGFÄLTIG LESEN UND FÜR SPÄTERES NACHSCHLAGEN AUFBEWAHREN.

IT_IMPORTANTE, LEGGERE E CONSERVARE QUESTO MANUALE D'ISTRUZIONE PER UN USO FUTURO.

INTENDED USE IN OFFICE OR HOME
ABOUT CARE AND MAINTENANCE OF TABLE :

1. To prevent the table from being scratched by hard objects, do not let metal objects break the surface of the table and leave bruise marks.
- 2, do not let the heat source has been baking, away from the source of fire. The surface should be fully considered to prevent dry cracking and deformation.
3. When in use, pay attention to the placement in a stable environment, otherwise there will be deformation.
- 4, prevent direct sunlight, can use gauze to prevent sunlight, so not only does not affect day lighting, but also can maintain the desk.
- 5, to check the desk, regularly clean up, remove the dust and corrosive gas and liquid, to prevent the desk
Corrosion affects the whole integrity of the table.
- 6, when using water to wipe the desktop, to wipe it clean, do not leave moisture on the desktop.
- 7, when cleaning to use a clean soft cloth, do not be too hard to wipe.

UTILISATION PRÉVUE POUR LE BUREAU OU LA MAISON
À PROPOS DE L'ENTRETIEN ET DE LA MAINTENANCE DE LA TABLE :

1. Pour éviter que la table ne soit rayée par des objets durs, ne laissez pas d'objets métalliques briser la surface de la table et laisser des marques d'ecchymoses.
2. Ne laissez pas la source de chaleur a été la cuisson, loin de la source de feu. La surface doit être entièrement considérée pour éviter les fissures sèches et les déformations.
3. Lors de l'utilisation, assurez-vous que la table soit placée dans un environnement stable, sinon il y aura des déformations.
4. Empêcher la lumière directe du soleil, vous pouvez utiliser une gaze pour protéger le bureau de la lumière directe du soleil, de sorte que non seulement l'éclairage de jour ne soit pas affecté, mais aussi que la table soit préservée.
5. Inspecter régulièrement la table, nettoyer et enlever la poussière ainsi que les matières corrosives (gaz et liquides) afin de prévenir la corrosion de la table.
La corrosion affecte l'intégrité entière de la table.
6. Lorsque vous utilisez de l'eau pour essuyer la table, nettoyez-la soigneusement, ne laissez pas de traces d'humidité sur la table.
7. Lorsque vous nettoyez le la table, utilisez un chiffon doux et propre, sans trop forcer.

PARA USARSE EN OFICINA Y HOGAR
CUIDADO Y MANTENIMIENTO DE LA MESA:

1. Tenga en cuenta de que los objetos duros metálicos pueden romper la superficie de la mesa y dejar marcas de magulladuras.
2. No ponga el producto cerca de la fuente de calor, y manténgalo lejos de la fuente de fuego. De lo contrario, puede producir grietas y deformaciones en la superficie.
3. Cuando no la utiliza, colóquela en un lugar estable, para evitar la deformación.
4. Puede usar una gasa para protegerla de la luz solar directa, lo cual no afecta la iluminación diurna, mientras tanto puede ofrecer protección a la mesa.
5. Regularmente revise y limpie la mesa, eliminando el polvo y las materias corrosivas, para proteger la mesa.
Las materias corrosivas pueden afectar la integridad de la mesa.
6. Después de limpiar la mesa con agua, tiene que secarla completamente. Tenga cuidado de no dejar humedad en la mesa.
7. Limpie la mesa con un paño suave y limpio, sin ejercer mucha fuerza.

Uso previsto em escritório ou em casa
SOBRE CUIDADOS E MANUTENÇÃO DE MESA:

1. Para evitar arranhões na mesa, não permita que objetos metálicos quebrem a superfície da mesa e deixem marcas de contusão.
2. Não exponha a mesa ao calor intenso ou fontes de fogo. A superfície deve ser totalmente considerada para evitar rachaduras secas e deformações.
3. Ao usar, preste atenção ao local onde é colocada em um ambiente estável, caso contrário, pode haver deformação.
4. Evite a luz solar direta e use gaze para evitar a luz solar, para que não afete a iluminação diurna e também possa manter a mesa.
5. Verifique a mesa regularmente, limpe-a e remova poeira, gás corrosivo e líquidos para evitar a corrosão que afeta toda a integridade da mesa.
6. Ao usar água para limpar a mesa, limpe-a completamente e não deixe umidade na mesa.
7. Ao limpar, use um pano macio e limpo e não limpe com força excessiva.

**VORGESEHENE VERWENDUNG IM BÜRO ODER ZU HAUSE
 ZUR PFLEGE UND WARTUNG DES TISCHES :**

1. Um zu verhindern, dass der Tisch durch harte Gegenstände zerkratzt wird, vermeiden Sie, dass Metallgegenstände die Oberfläche des Tisches beschädigen und blaue Flecken hinterlassen.
2. Entfernen Sie die Wärmequelle für das Backen nicht von der Feuerquelle. Die Oberfläche sollte vollständig berücksichtigt werden, um Trockenrisse und Verformungen zu verhindern.
3. Wenn in Gebrauch, achten Sie auf die Aufstellung in einer stabilen Umgebung, sonst gibt es Verformungen.
4. Verhindern Sie direktes Sonnenlicht, Sie können Gaze verwenden, um Sonnenlicht zu verhindern, so dass nicht nur die Tagesbeleuchtung nicht beeinträchtigt wird, sondern auch der Schreibtisch erhalten werden kann.
5. Den Schreibtisch prüfen, regelmäßig aufräumen, den Staub und korrosives Gas und Flüssigkeit entfernen, um den Schreibtisch zu schützen.
 Korrosion beeinträchtigt die gesamte Integrität des Tisches.
6. Wenn Sie Wasser verwenden, um den Schreibtisch zu wischen, um ihn sauber zu wischen, hinterlassen Sie keine Feuchtigkeit auf dem Schreibtisch.
7. Bei der Reinigung ein sauberes, weiches Tuch verwenden, nicht zu hart wischen.

**DESTINAZIONE D'USO IN UFFICIO O A CASA
 CURA E MANUTENZIONE DELLA SCRIVANIA:**

1. Per evitare che la scrivania venga graffiata da oggetti duri, non lasciare che gli oggetti metallici rompano la superficie della scrivania e lascino le tracce.
2. Non permette che la fonte di calore la inforni, tenerla lontana dalla fonte di fuoco. La superficie dovrebbe essere considerata completamente per evitare crepe e deformazioni secche.
3. Quando è in uso, prestare attenzione al posizionamento in un ambiente stabile, altrimenti si verificherà una deformazione.
4. Prevenire la luce solare diretta. Si può utilizzare una garza per prevenire la luce solare in modo che non influisca sull'illuminazione diurna, ma possa anche mantenere la scrivania.
5. Controllare la scrivania, pulire regolarmente, rimuovere la polvere e il gas e il liquido corrosivi per mantenere che la scrivania.
 La corrosione influenza l'intera integrità della scrivania.
6. Quando si utilizza l'acqua per pulire la superficie, non lasciare umidità sulla superficie.
7. Quando la pulisci, utilizza un panno morbido pulito, non pulirla con forza troppo forte.

EN Operation Instructions

- Please confirm that all components are present before beginning assembly.
- For the protection of your furniture, place all parts on a clean and smooth surface to prevent any damage.
- Please assemble the furniture by 2 persons or more.
- Do not confuse similar screws.
- Do not tighten bolts fully until all parts are connected!
- Please periodically check all fitting and re-tighten as necessary.

FR Instructions pratiques

- Avant de commencer l'assemblage, veuillez confirmer que tous les composants sont présents.
- Pour la protection de votre mobilier, placez toutes les pièces sur une surface propre et lisse de manière à éviter tout dommage.
- Veuillez procéder au montage de votre mobilier par 2 personnes ou plus.
- Ne pas confondre des vis similaires.
- Ne serrez pas les boulons à fond tant que toutes les pièces ne sont pas connectées!
- Veuillez vérifier périodiquement toutes les pièces de montage et les resserrer si nécessaire.

ES Instrucciones de operación

- Por favor, confirme que todos los componentes están presentes antes de comenzar el ensamblaje.
- Para proteger sus muebles, coloque todas las piezas sobre una superficie limpia y lisa para evitar daños.
- El montaje debe ser realizado por 2 o más personas.
- No confunda tornillos similares.
- No apriete los tornillos completamente hasta que todas las partes están conectadas!
- Revise regularmente todos los accesorios y vuelva a apretarlos si es necesario.

PT Instruções de funcionamento

- Por favor, confirme que todos os componentes estão presentes antes de começar a montagem.
- Para proteger o seu mobiliário, coloque todas as peças numa superfície limpa e lisa para evitar danos.
- A montagem deve ser realizada por 2 ou mais pessoas.
- Não confundir parafusos semelhantes.
- Não apertar completamente os parafusos até que todas as peças estejam encaixadas!
- Verifique regularmente todos os acessórios e aperte-os novamente, se necessário.

DE Betriebsanleitung

- Bitte bestätigen Sie, dass alle Komponenten vor Beginn der Montage vorhanden sind.
- Legen Sie zum Schutz Ihres Möbels alle Teile auf eine saubere und glatte Unterlage, um Beschädigungen zu vermeiden.
- Bitte bauen Sie die Möbel mit mindestens 2 Personen zusammen.
- Verwechseln Sie ähnliche Schrauben nicht.
- Ziehen Sie die Schrauben erst fest an, wenn alle Teile verbunden sind!
- Überprüfen Sie bitte regelmäßig alle Befestigungen und ziehen Sie diese gegebenenfalls nach.

IT Istruzioni per l'uso

- Prima di iniziare l'assemblaggio, confermare che tutti i componenti siano presenti.
- Per proteggere il tuo mobile, posiziona tutte le parti su una superficie pulita e liscia per evitare danni.
- Si prega di assemblare il mobile da 2 persone o più.
- Non confondere le viti simili.
- non serrare completamente i bulloni fino a tutte le parti non sono ancora collegate!
- Si prega di controllare periodicamente tutti i componenti di fissaggio e serrarli nuovamente se necessario.

PARTS

1 x 2

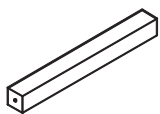

2 x 2



3 x 2

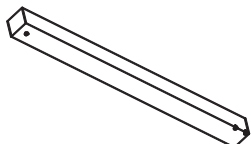

4 x 1

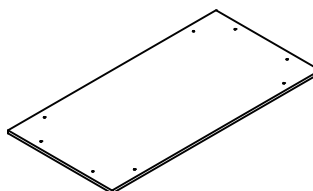

5 x 1

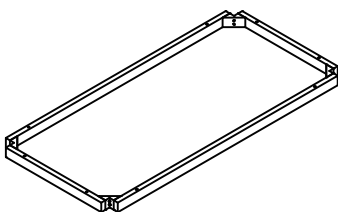

HARDWARE

A x 4

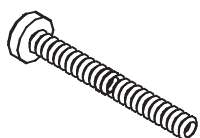

M6*55;

B x 8

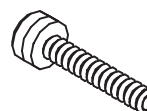

M8*35;

C x 8

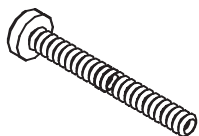

M6*50;

D x 4

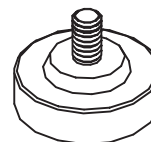

M8;

E x 1

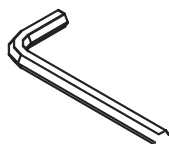

M6;

F x 1

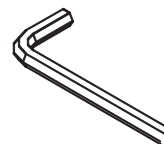

M8;

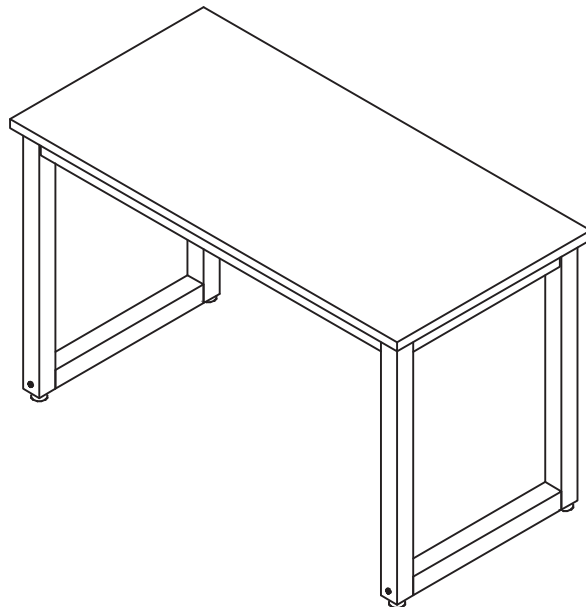
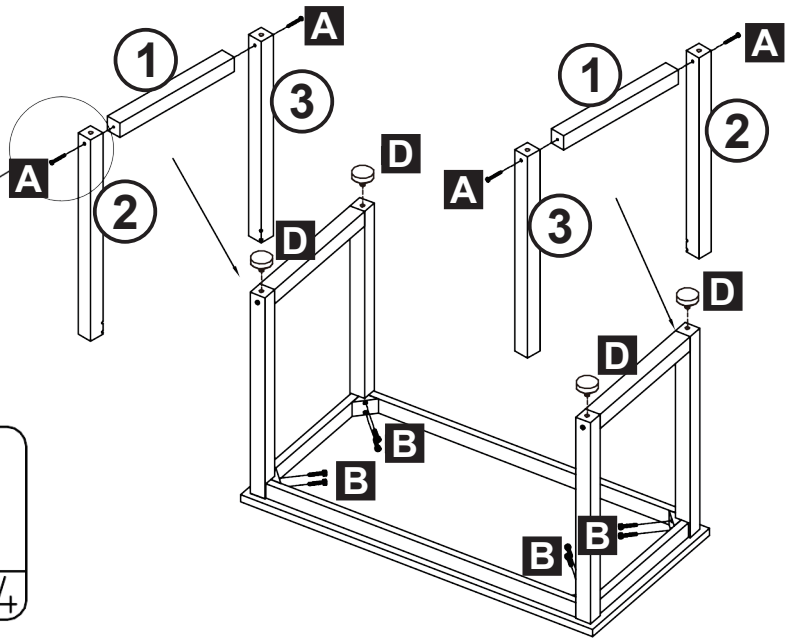
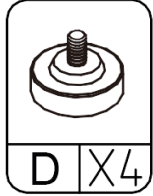
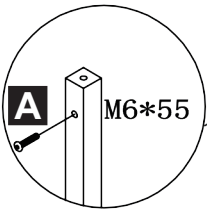
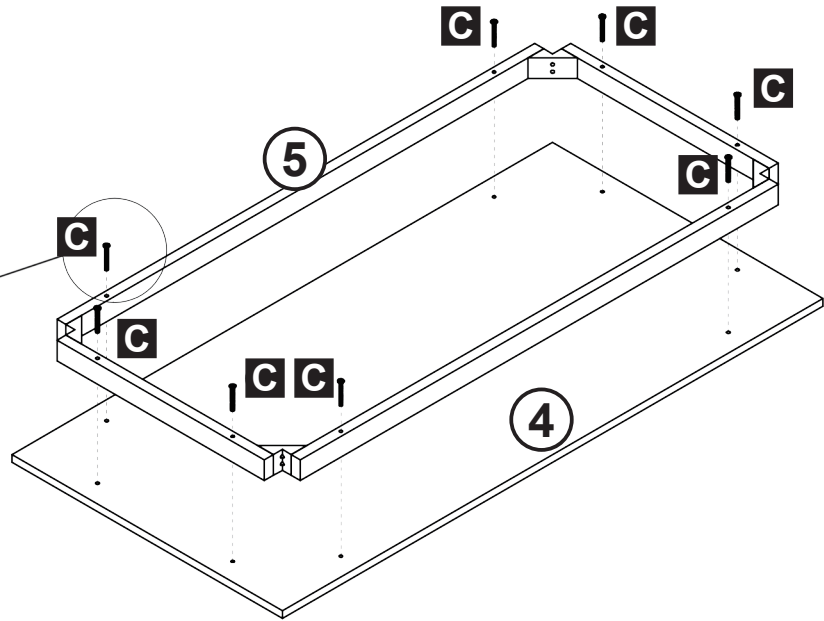
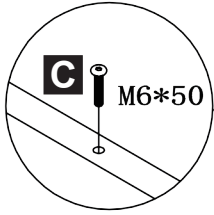

If you have any questions, please contact our customer care center.

US

Our contact details are below:

 001-877-644-9366

 customerservice@aosom.com

Imported by Aosom LLC

27150 SW Kinsman Rd Wilsonville, OR 97070 USA

MADE IN CHINA

Si tiene alguna pregunta, comuníquese con nuestro Centro de Atención al Cliente.

ES

Nuestros datos de contacto son los siguientes:

 0034-931294512

 atencioncliente@aosom.es

IMPORTADOR:

SPANISH AOSOM, S.L.

C/ ROC GROS, Nº 15. 08550, ELS HOSTALETES DE BALENYÀ, SPAIN.

B66295775

WWW.AOSOM.ES

HECHO EN CHINA

If you have any questions, please contact our customer care center.

CA

Our contact details are below:

 416-792-6088

 customerservice@aosom.ca

Imported by Aosom Canada Inc.

7270 Woodbine Avenue, Unit 307, Markham,

Ontario Canada L3R 4B9

MADE IN CHINA

Se tiver alguma dúvida, por favor contacte o nosso Centro de Atendimento ao Cliente.

PT

Os nossos dados de contacto são os seguintes:

 0034-931294512 (SEG-SEX DAS 7:30H ÀS 16:30H)

 info@aosom.pt.

IMPORTADOR:

SPANISH AOSOM, S.L

C.ROC GROS N.15, 08550. ELS HOSTALETES DE BALENYÀ

WWW.AOSOM.PT

Si vous avez la moindre question, veuillez contacter notre centre d'assistance à la clientèle.

Nos coordonnées sont les suivantes:

 416-792-6088

 customerservice@aosom.ca

Importé par Aosom Canada Inc.

7270 Woodbine Avenue, unité 307,

Markham, Ontario Canada L3R 4B9

Fabriqué en Chine

Wenn Sie Fragen haben, wenden Sie sich bitte an unser Kundendienstzentrum.

DE

Unsere Kontaktdaten stehen unten:

 0049-0(40)-88307530  service@aosom.de

ADRESSE DES IMPORTEURE:

MH Handel GmbH

Wendenstraße 309

D-20537 Hamburg

Germany

IN CHINA HERGESTELLT

If you have any questions, please contact our customer care center.

UK

Our contact details are below:

 0044-800-240-4004

 enquiries@mhstar.co.uk

IMPORTER ADDRESS:

MH STAR UK LTD

Unit 27, Perivale Park,

Horsenden lane South

Perivale, UB6 7RH

MADE IN CHINA

In caso di dubbio, si prega di contattare il nostro centro assistenza clienti.

IT

I nostri dettagli di contatto sono di seguito:

 0039-0249471447  clienti@aosom.it

IMPORTATO DA:

AOSOM Italy srl

Centro Direzionale Milanofiori

Strada 1 Palazzo F1

20057 Assago (MI)

P.I.: 08567220960

FATTO IN CINA

Si vous avez la moindre question, veuillez contacter notre centre d'assistance à la clientèle.

FR

Nos coordonnées sont les suivantes:  0033-1-84166106  aosom@mhfrance.fr

Importé par: MH France 2, rue Maurice Hartmann 92130 Issy-les-Moulineaux

Fabriqué en Chine

France



FR

**DONNEZ
OU
RECYCLEZ**



OU



OU



ASSOCIATION LIVRAISON DÉCHÈTERIE

Adresses sur quefairedemesdechets.fr