

kleanpin

IN230700183V02_UK_ES_DE_IT

834-396

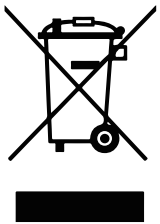
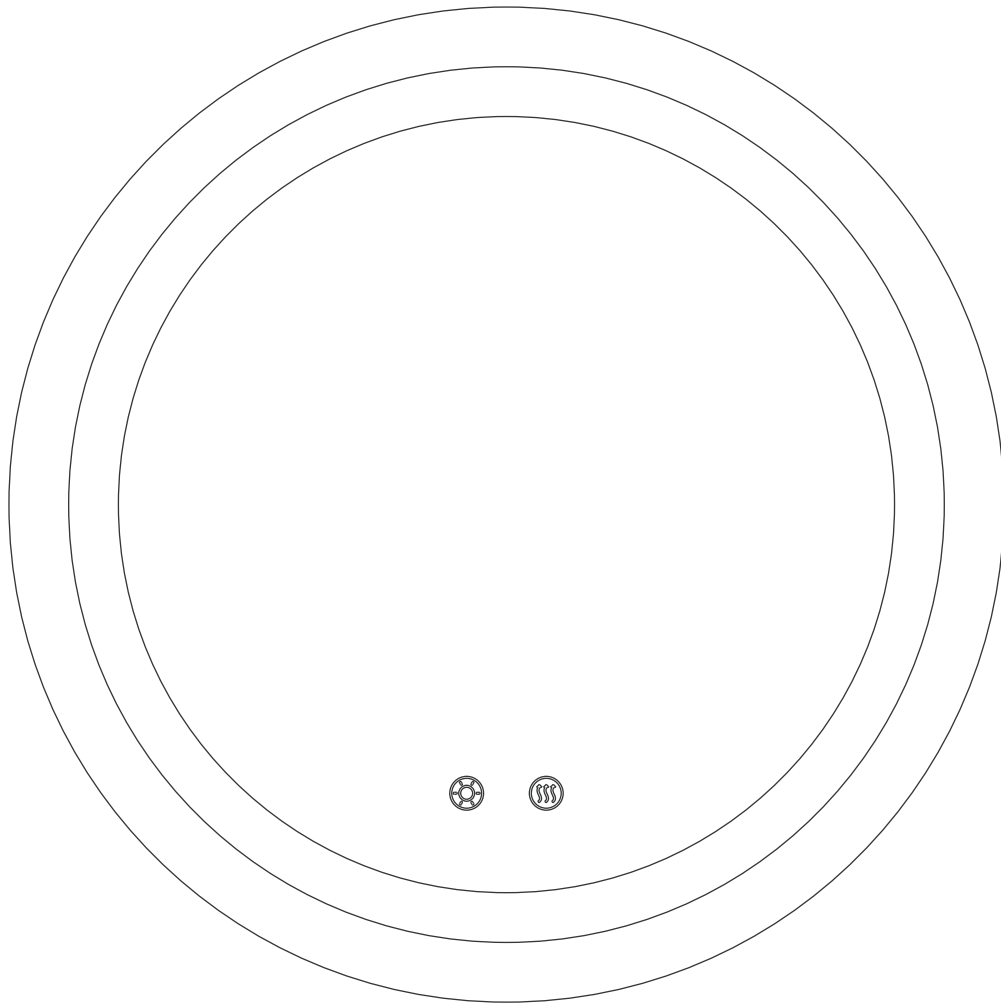

CE

**EN_IMPORTANT, RETAIN FOR FUTURE REFERENCE: READ CAREFULLY.
ES_IMPORTANTE, LEA DETENIDAMENTE Y GUARDE PARA FUTURAS REFERENCIAS.
DE_WICHTIG! SORFGFÄLTIG LESEN UND FÜR SPÄTERES NACHSCHLAGEN AUFBEWAHREN.
IT_IMPORTANTE, LEGGERE E CONSERVARE QUESTO MANUALE D'ISTRUZIONE PER UN USO FUTURO.**

COMPONENTS

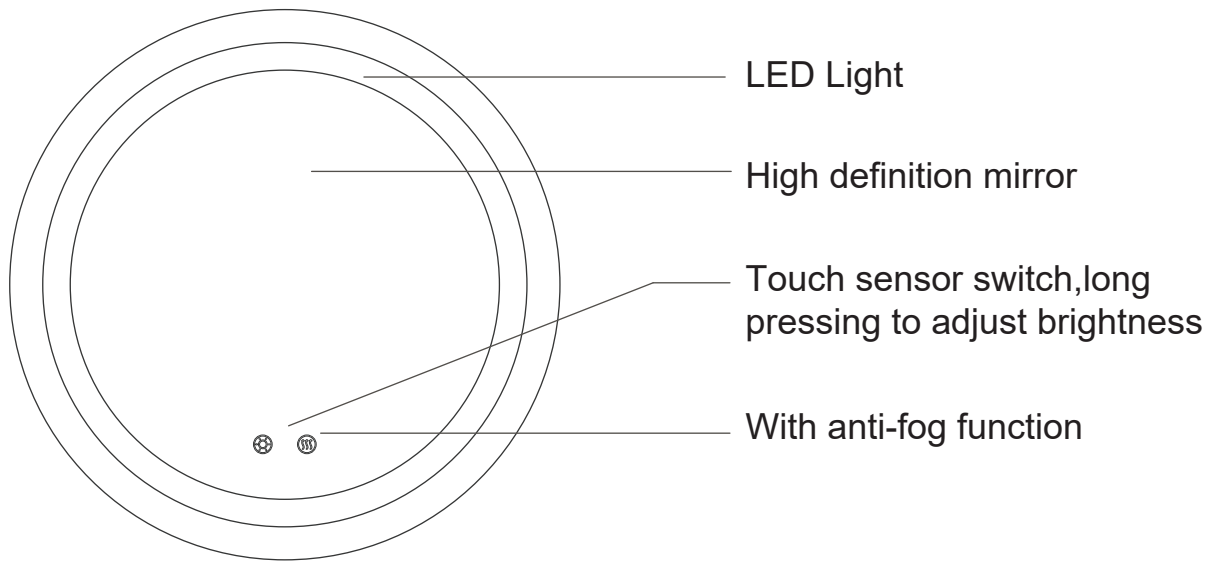

SPECIFICATIONS

Product name: Wall-mounted LED bathroom mirror
 Material: Aluminium frame and glass
 Colour temperature: 3000-6500K
 Power supply: Power driver, 230V/50Hz
 Product size: 50H x 50Lcm
 This product contains a light source of energy efficiency class F.

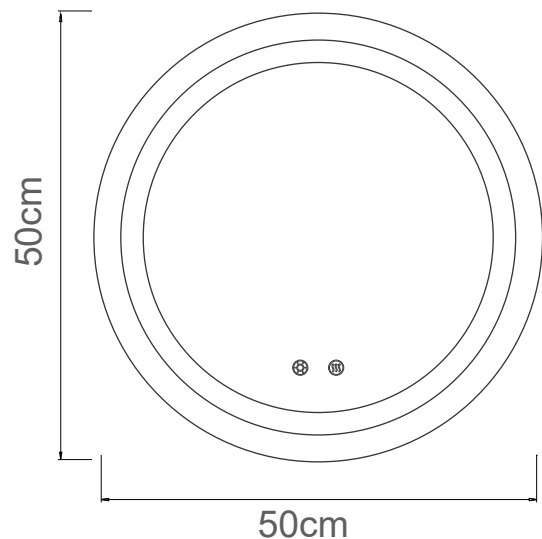

FEATURES



Glass mirror is 5mm thick



Choose warm, natural or cool lighting



Touch sensor



Anti fog function



Adapter

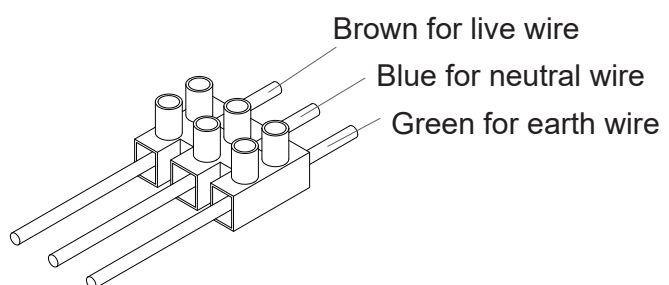

LIST OF ITEMS

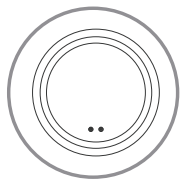

LED Bathroom Mirror



Instruction Manual

OPERATING INSTRUCTIONS

- (1) Please use the standard plug to turn the mirror on.
- (2) The touch sensor turns red when plugged in. Press 'power' to turn on. Press 'anti fog' to activate this function.
- (3) The lights are at full brightness when on. Hold 'Power' to adjust the brightness.
- (4) Press 'Power' to switch between warm, natural and cool lighting. Press again to turn off.
- (5) Unplug when the appliance is turned off.

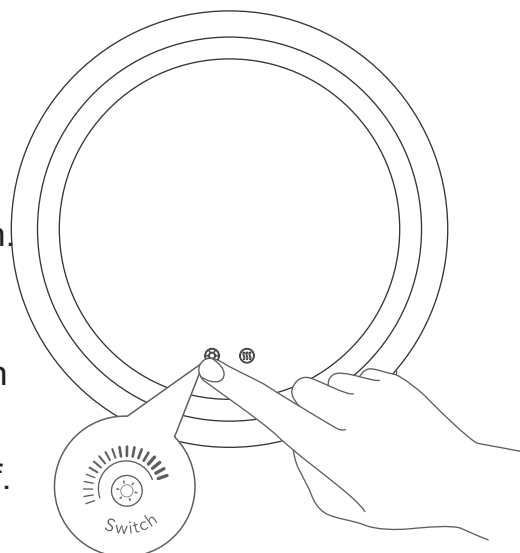

INSTALLATION METHOD

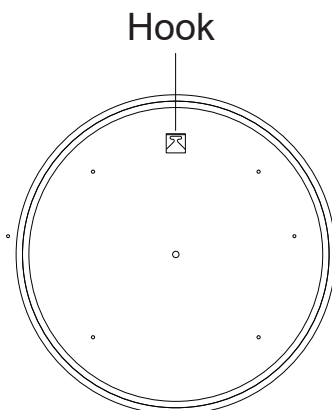

- ① Ensure you have a tape measure, electric drill, hammer, screwdriver and pliers.
- ② Select your desired height on a solid wall and mark two dots with a horizontal distance.
- ③ Drill 3cm holes into the marked dots. Place the rubber plug into the holes and screw in.
- ④ Hang the product with the hook on the back.

REPLACE THE LIGHT STRIP



Prepare screwdriver, knife



Take off the screw on the back

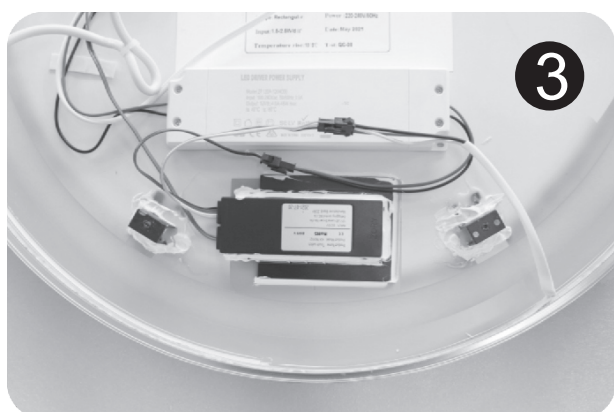

You can see two connector, the yellow one is touch screen connector



Cut off the connect of touch screen and light strip, take off the connect with yellow red white line and black white color connector



Take off the light strip from left to the right slowly



SAFETY INSTRUCTIONS

Please read these safety instructions carefully before using this product.

- ⓘ Do not disassemble or alter the components of the mirror.
- ⓘ Press the touch sensor gently.
- ⓘ Keep the mirror dry. Moisture reduces the sensitivity of the appliance.
- ⓘ Turn off and keep out of direct sunlight when stored away. Keep out the reach of children.
- ⓘ Do not use the mirror if it is faulty.

* We reserves the right of any modification of the product involving design and specification, all the materials here are for your reference only and are subject to the products you received. No further notice be given for any technical parameters changed.

COMPONENTES

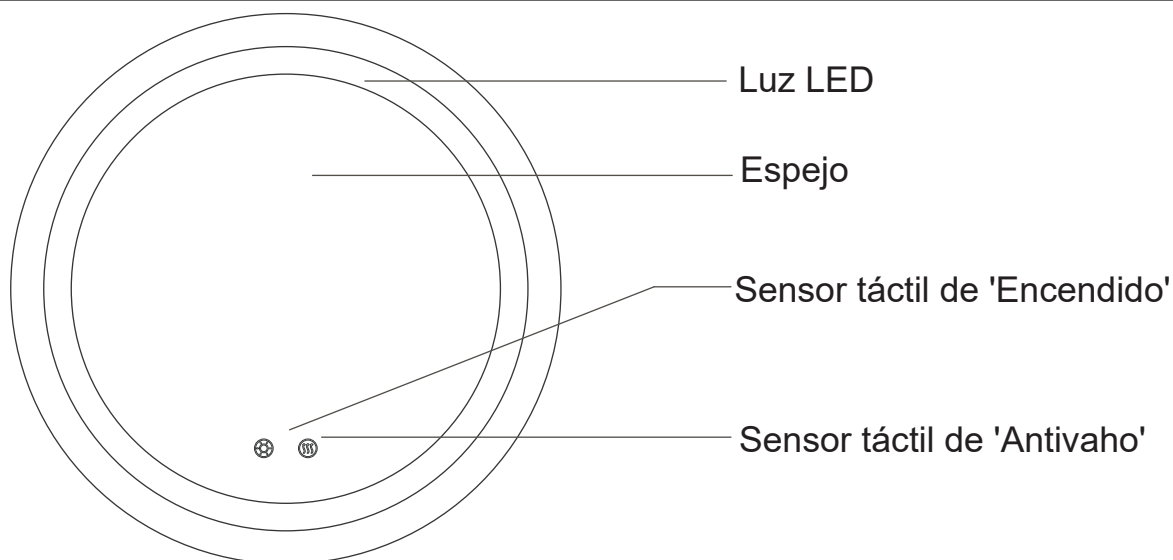

ESPECIFICACIONES

Nombre del producto: Espejo de baño de pared con luz LED

Material: Marco de aluminio y vidrio.

Temperatura de color: 3000-6500K

Fuente de alimentación: Conductor de potencia, 230V/50Hz

Tamaño del producto: 50 Altura x 50 Longitud

Este producto contiene una fuente de luz de clase de eficiencia energética F.

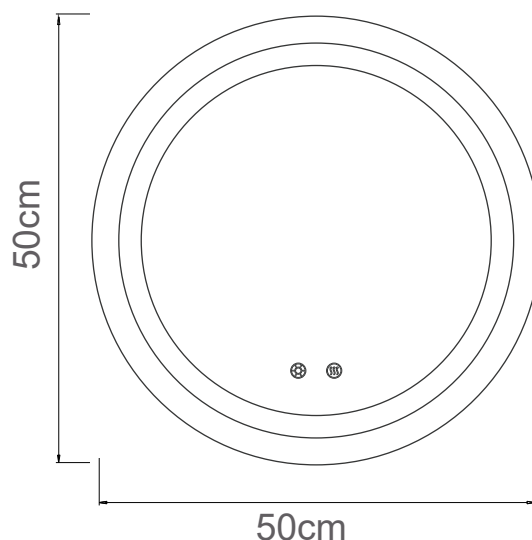

CARACTERÍSTICAS



El grosor del espejo de vidrio es de 5 mm.



Seleccionar un estilo de iluminación entre "cálido", "natural" o "frío".



Sensor táctil



Función de 'Antivaho'



Adaptador

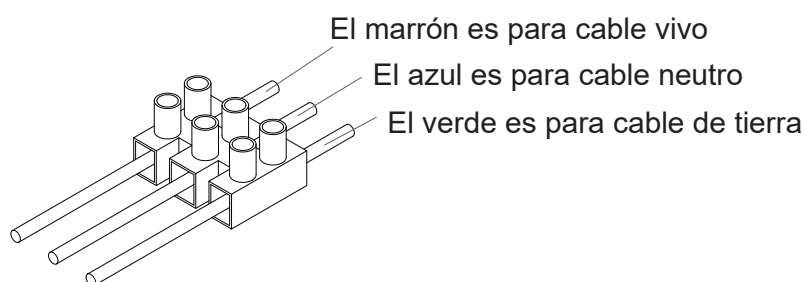

LISTA DE ARTÍCULOS

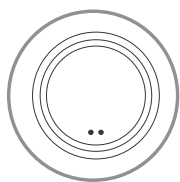

Espejo de baño con luz LED



Manual de instrucciones

INSTRUCCIONES DE OPERACIÓN

- (1) Utilice el enchufe estándar para encender el espejo.
- (2) El sensor táctil se vuelve rojo cuando el espejo está enchufado. Presione la tecla de "Encendido" para encenderlo. Presione la tecla de 'Antivaho' para activar la función correspondiente.
- (3) Todo el brillo de las luces está encendido después de encender el espejo. Mantenga presionada la tecla de "Encendido" para ajustar el brillo.
- (4) Presione la tecla de 'Encendido' para cambiar la iluminación entre los 3 estilos de "cálido", "natural" y "frío". Presione la tecla de 'Encendido' nuevamente para apagar el espejo.
- (5) Desenchufe el espejo cuando esté apagado.

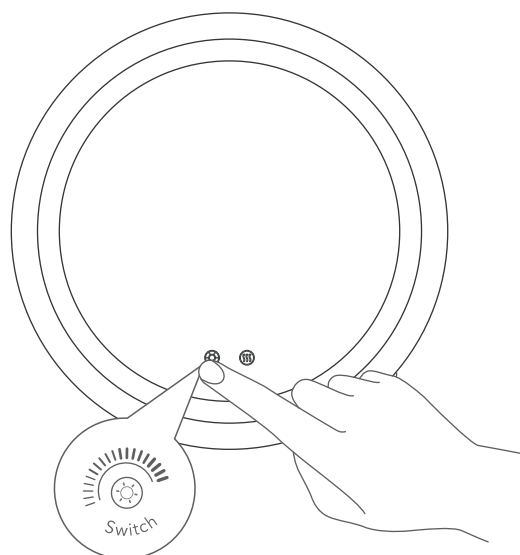

MÉTODO DE INSTALACIÓN

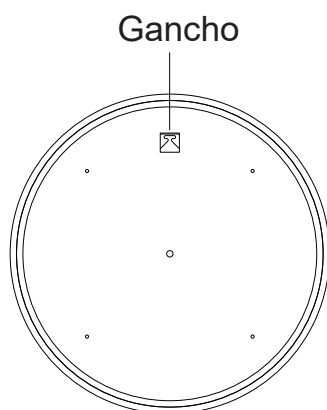

- (1) Asegúrese de tener la cinta métrica, el taladro eléctrico, el martillo, el destornillador y los alicates.
- (2) Seleccione la altura ideal para instalar el espejo en la pared sólida y marque 2 puntos de modo que la distancia horizontal entre ellos son de 39,5 cm.
- (3) Taladre los agujeros con profundidad de 3 cm en los puntos marcados. Coloque el tapón de goma en cada agujero correspondientemente y atornille los tapones.
- (4) Cuelgue el espejo con el gancho ubicado en la parte trasera.

REEMPLAZO DE LA TIRA DE LUZ



1
Prepare un destornillador y un cuchillo.



2
Quite el tornillo de la parte trasera.

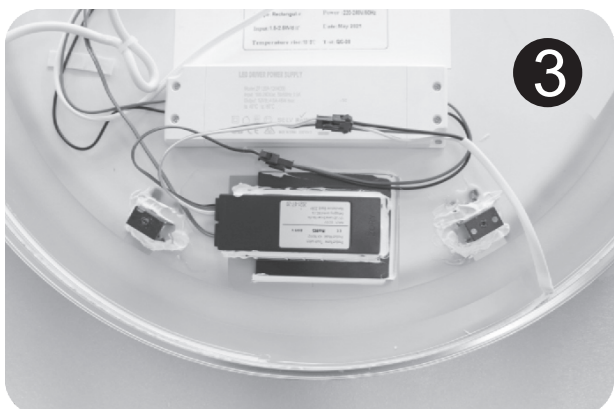

3
Puede ver 2 conectores, el conector amarillo es el conector de la pantalla táctil.



4
Corte la conexión entre la pantalla táctil y la tira de luz, quite la conexión de las líneas blanca, roja, y amarilla y los conectores de color blanco y negro.



5
Saque la tira de luz de izquierda a derecha cuidadosamente.



INSTRUCCIONES DE SEGURIDAD

Lea cuidadosamente todas estas instrucciones de seguridad antes de utilizar el espejo.

- ⓘ No desmonte ni modifique el espejo.
- ⓘ Presione suavemente el sensor táctil.
- ⓘ Mantenga el espejo seco. La humedad reducirá la sensibilidad del espejo.
- ⓘ Apague el espejo y manténgalo alejado de la luz solar directa al almacenarlo. Manténgalo alejado de los niños.
- ⓘ No utilice el espejo si no funciona correctamente.

* Nos reservamos el derecho de realizar cualquier modificación en el diseño y las especificaciones del producto, todos los materiales descritos aquí son solo para su referencia, y consulte el producto que recibió. Los parámetros técnicos están sujetos a cambios sin previo aviso.

KOMPONENTEN

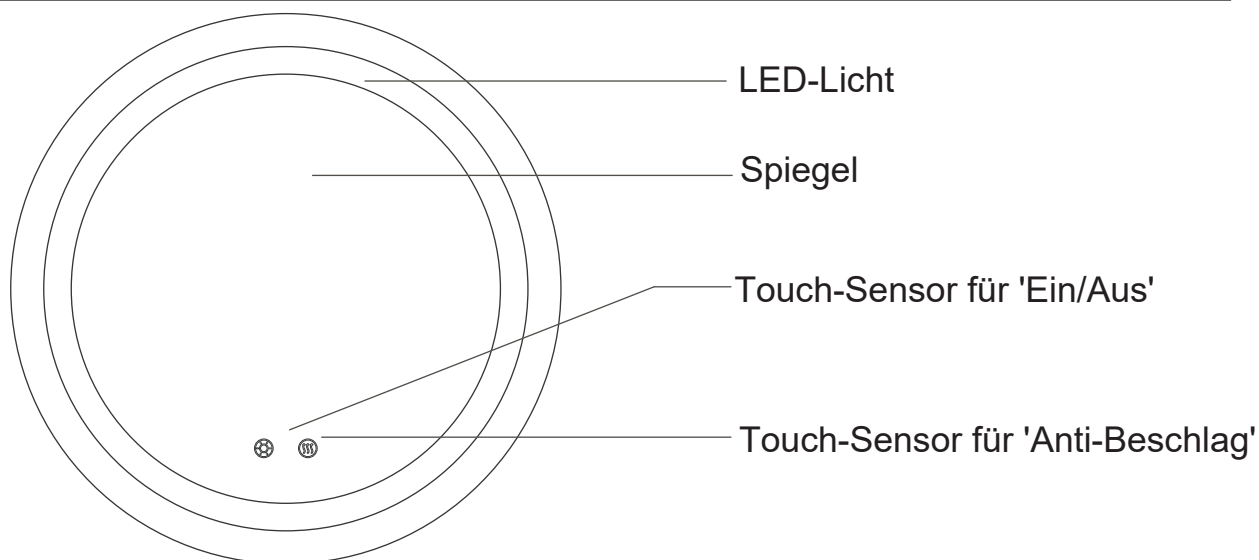

SPEZIFIKATIONEN

Produktname: Wandmontierter LED-Badezimmerspiegel

Material: Aluminiumrahmen und Glas

Farbtemperatur: 3000-6500K

Stromversorgung: Netzteil, 230V/50Hz

Produktgröße: 50H x 50L cm

Dieses Produkt enthält eine Lichtquelle der Energieeffizienzklasse F.

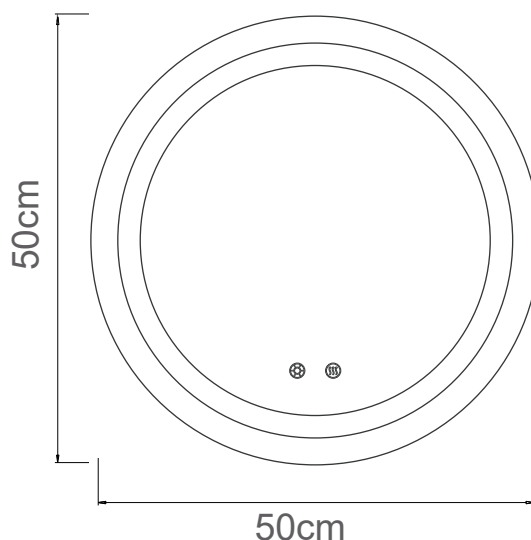

MERKMALE



Der Glasspiegel hat eine Dicke von 5 mm



Wählen Sie warmes, natürliches oder kaltes Licht



Touch-Sensor



Anti-Beschlag-Funktion



Adapter

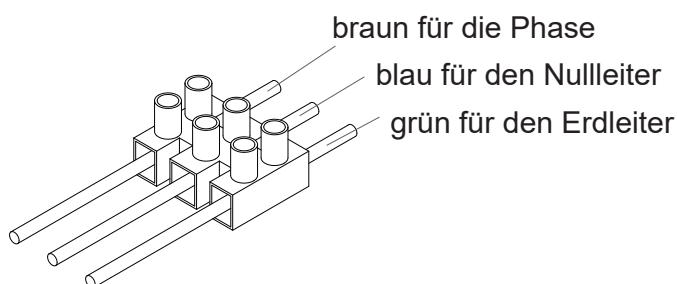

LISTE DER ARTIKEL

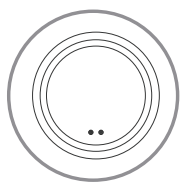

LED-Badezimmerspiegel



Bedienungsanleitung

BEDIENUNGSANLEITUNG

- (1) Verwenden Sie den Standardstecker, um den Spiegel einzuschalten.
- (2) Der Touch-Sensor wird rot, wenn der Spiegel eingesteckt ist. Drücken Sie die 'Ein/Aus'-Taste, um ihn einzuschalten. Drücken Sie die 'Anti-Beschlag'-Taste, um die Funktion zu aktivieren.
- (3) Die Lichter haben volle Helligkeit, wenn der Spiegel eingeschaltet ist. Halten Sie die 'Ein/Aus'-Taste gedrückt, um die Helligkeit anzupassen.
- (4) Drücken Sie die 'Ein/Aus'-Taste, um zwischen den Beleuchtungsmodi 'warm', 'natürlich' und 'kalt' zu wechseln. Drücken Sie erneut, um den Spiegel auszuschalten.
- (5) Ziehen Sie den Stecker, wenn der Spiegel ausgeschaltet ist.

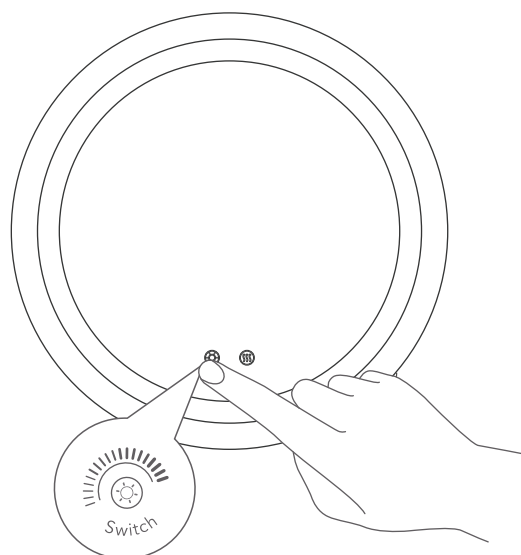

INSTALLATIONSMETHODE

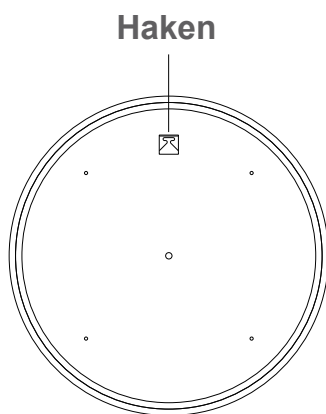

- (1) Stellen Sie sicher, dass Sie ein Maßband, einen elektrischen Bohrer, einen Hammer, einen Schraubendreher und eine Zange haben.
- (2) Wählen Sie Ihre gewünschte Höhe an einer soliden Wand aus und markieren Sie zwei Punkte mit einem horizontalen Abstand von 39,5 cm.
- (3) Bohren Sie 3 cm tiefe Löcher in die markierten Punkte. Setzen Sie die Gummistöpsel in die Löcher ein und schrauben Sie sie fest.
- (4) Hängen Sie den Spiegel mit dem Haken auf der Rückseite auf.

ERSATZ DES LICHTSTREIFENS



1
Bereiten Sie einen Schraubendreher und ein Messer vor.



2
Entfernen Sie die Schraube auf der Rückseite.



3
Sie sehen 2 Anschlüsse, wobei der gelbe Anschluss der Touchscreen-Anschluss ist.



4
Schneiden Sie die Verbindung zwischen Touchscreen und Lichtstreifen ab, trennen Sie die Verbindung der weißen, roten und gelben Leitungen sowie der schwarzen und weißen farbigen Anschlüsse.



5
Entfernen Sie den Lichtstreifen vorsichtig von links nach rechts.



SICHERHEITSHINWEISE

Bitte lesen Sie diese Sicherheitshinweise sorgfältig durch, bevor Sie dieses Produkt verwenden.

- ⓘ Zerlegen oder verändern Sie nicht die Bestandteile des Spiegels.
- ⓘ Drücken Sie vorsichtig auf den Berührungssensor.
- ⓘ Halten Sie den Spiegel trocken. Feuchtigkeit verringert die Empfindlichkeit des Geräts.
- ⓘ Schalten Sie das Gerät aus und schützen Sie es vor direkter Sonneneinstrahlung, wenn Sie es abstellen. Bewahren Sie ihn außerhalb der Reichweite von Kindern auf.
- ⓘ Benutzen Sie den Spiegel nicht, wenn er defekt ist.

* Wir behalten uns das Recht vor, Änderungen am Produkt vorzunehmen, die das Design und die Spezifikation betreffen. Alle hier aufgeführten Materialien dienen nur als Referenz und unterliegen den Produkten, die Sie erhalten haben. Es werden keine weiteren Hinweise auf geänderte technische Parameter gegeben.

COMPONENTI

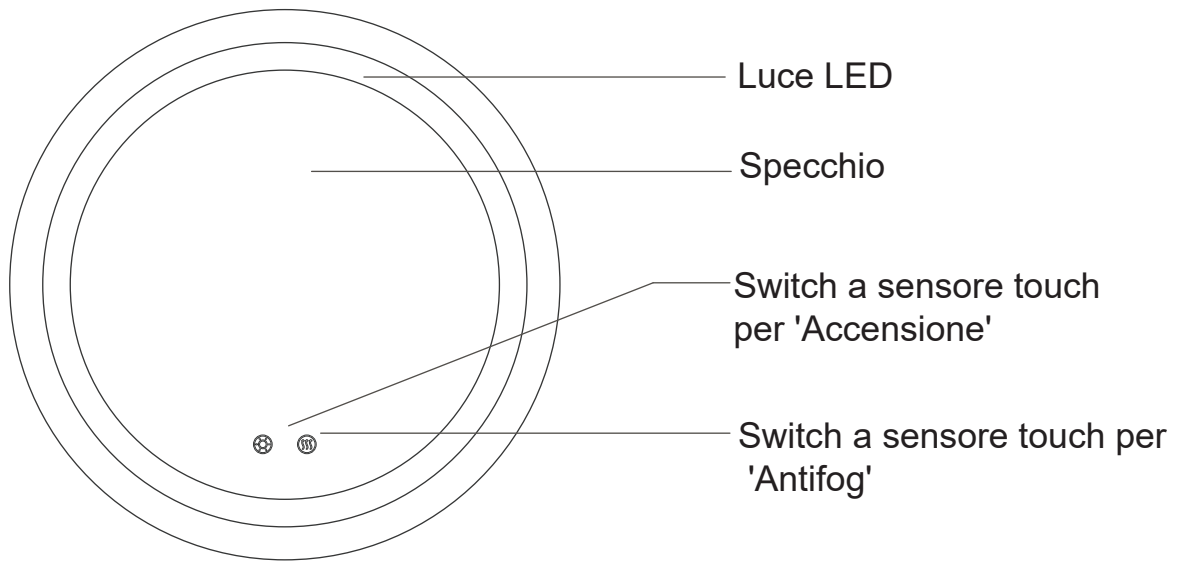

SPECIFICHE

Nome prodotto: Specchio da bagno a LED da parete

Materiale: Cornice in alluminio e vetro

Temperatura colore: 3000-6500K

Alimentazione: Alimentatore, 230V/50Hz

Dimensioni prodotto: 50H x 50L cm

Questo prodotto contiene una fonte luminosa di classe di efficienza energetica F.

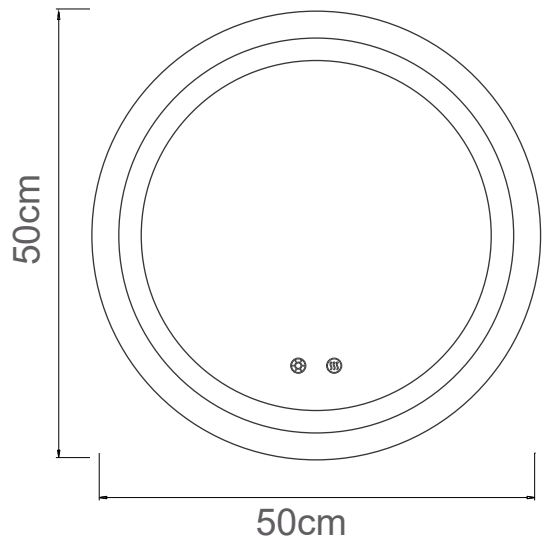

CARATTERISTICHE



Lo spessore del vetro dello specchio è di 5 mm



Scegli tra illuminazione 'calda', 'naturale' o 'fredda'



Switch a sensore touch



Funzione antifog



Adattatore

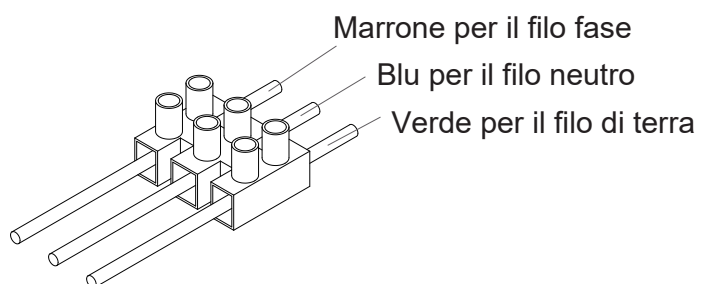

ELENCO DEGLI OGGETTI

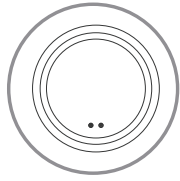

Specchio da bagno a LED



Manuale di istruzioni

ISTRUZIONI PER L'USO

- (1) Utilizzare la spina standard per accendere lo specchio
- (2) Il sensore touch diventa rosso quando lo specchio è collegato. Premere il pulsante 'Accensione' per accenderlo. Premere il pulsante 'Antifog' per attivare la relativa funzione.
- (3) Le luci sono alla massima luminosità quando sono accese. Tenere premuto il pulsante 'Accensione' per regolare la luminosità.
- (4) Premere il pulsante 'Accensione' per passare tra le opzioni di illuminazione 'calda', 'naturale' e 'fredda'. Premere nuovamente per spegnere lo specchio.
- (5) Scollegare lo specchio quando è spento.

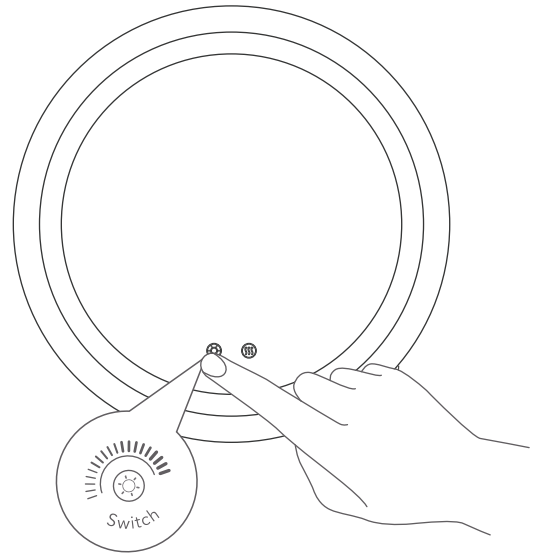

METODO DI INSTALLAZIONE

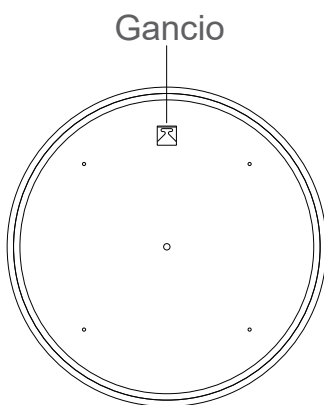

- (1) Assicurarsi di avere un metro, un trapano elettrico, un martello, un cacciavite e una pinza.
- (2) Selezionare l'altezza desiderata su una parete solida e segnare due punti a una distanza orizzontale di 39,5 cm.
- (3) Trapanare fori di 3 cm nei punti segnati. Inserire i tappi di gomma nei fori e avvitarli saldamente.
- (4) Appendere lo specchio al gancio sul retro.

SOSTITUZIONE DELLA STRISCIA LUMINOSA

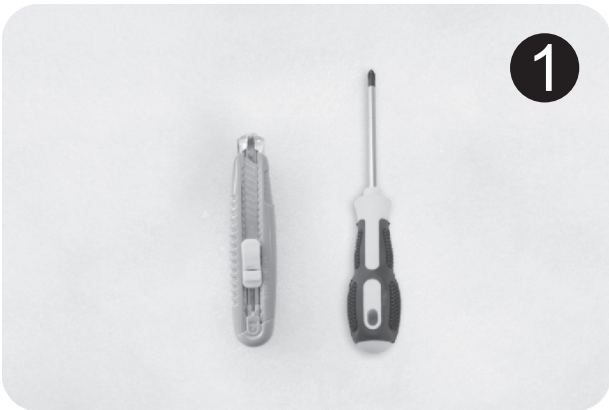

1

Preparare un cacciavite e un coltello.



2

Togliere la vite sul retro.

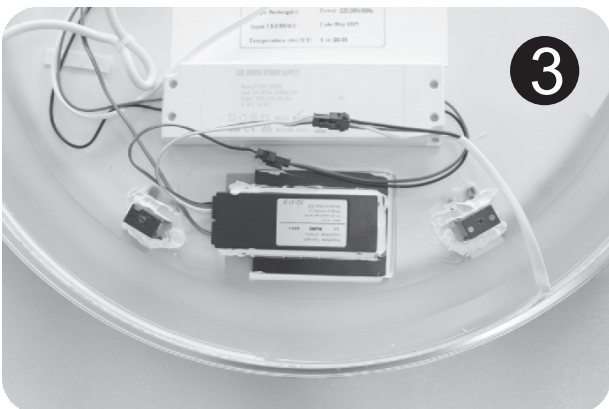

3

Si vedono due connettori, quello giallo è il connettore touch screen.



4

Tagliare la connessione tra il touch screen e la striscia luminosa, staccare la connessione dei fili bianco, rosso e giallo e i connettori di colore bianco e nero.



5

Rimuovere la striscia luminosa lentamente da sinistra a destra.



ISTRUZIONI DI SICUREZZA

Si prega di leggere attentamente queste istruzioni di sicurezza prima di utilizzare il prodotto.

- ⓘ Non smontare o alterare lo specchio.
- ⓘ Premere il sensore touch delicatamente.
- ⓘ Mantenere lo specchio asciutto. L'umidità riduce la sensibilità dell'apparecchio.
- ⓘ Spegnere l'apparecchio e tenerlo lontano dalla luce solare diretta quando viene riposto.
Tenere fuori dalla portata dei bambini.
- ⓘ Non usare se lo specchio è guasto.

* Ci riserviamo il diritto di qualsiasi modifica del prodotto che coinvolga il design e le specifiche tecniche, tutte le indicazioni qui riportate sono solo per riferimento e sono soggette al prodotto ricevuto. Nessun ulteriore avviso sarà dato per eventuali parametri tecnici modificati.

UK

If you have any questions, please contact our customer care center.

Our contact details are below:



0044-800-240-4004



enquiries@mhstar.co.uk

IMPORTER ADDRESS:

MH STAR UK LTD
Unit 27, Perivale Park,
Horsenden lane South
Perivale, UB6 7RH
MADE IN CHINA

ES

Si tiene alguna pregunta, comuníquese con nuestro Centro de Atención al Cliente. Nuestros datos de contacto son los siguientes:



0034-931294512



atencioncliente@aosom.es

IMPORTADOR:

SPANISH AOSOM, S.L.
C/ ROC GROS, N° 15. 08550, ELS HOSTALETS DE
BALENYÀ, SPAIN.
B66295775
WWW.AOSOM.ES
ATENCIONCLIENTE@AOSOM.ES
TEL: 931294512
HECHO EN CHINA

FR

Si vous avez la moindre question, veuillez contacter notre centre d'assistance à la clientèle.

Nos coordonnées sont les suivantes:



0033-1-84166106



aosom@mhfrance.fr

Importé par:

MH France
2, rue Maurice Hartmann
92130 Issy-les-Moulineaux
France
Fabriqué en Chine

PT

Se tiver alguma dúvida, por favor contacte o nosso Centro de Atendimento ao Cliente. Os nossos dados de contacto são os seguintes:



0034-931294512



info@aosom.pt.

IMPORTADOR:

SPANISH AOSOM, S.L.
C.ROC GROS N.15, 08550. ELS HOSTALETS DE BALENYÀ
TEL: 931294512 (SEG-SEX DAS 7:30H ÀS 16:30H)
INFO@AOSOM.PT
WWW.AOSOM.PT

DE

Wenn Sie Fragen haben, wenden Sie sich bitte an unser Kundendienstzentrum.

Unsere Kontaktdaten stehen unten:



0049-0(40)-88307530



service@aosom.de

ADRESSE DES IMPORTEUR:

MH Handel GmbH
Wendenstraße 309
D-20537 Hamburg
Germany
IN CHINA HERGESTELLT

IT

In caso di dubbio, si prega di contattare il nostro centro assistenza clienti. I nostri dettagli di contatto sono di seguito:



0039-0249471447



clienti@aosom.it

IMPORTATO DA:

AOSOM Italy srl
Centro Direzionale Milanofiori
Strada 1 Palazzo F1
20057 Assago (MI)
P.I.: 08567220960
FATTO IN CINA