

# PawHut

IN230800001V01\_GL

**D51-388V01**

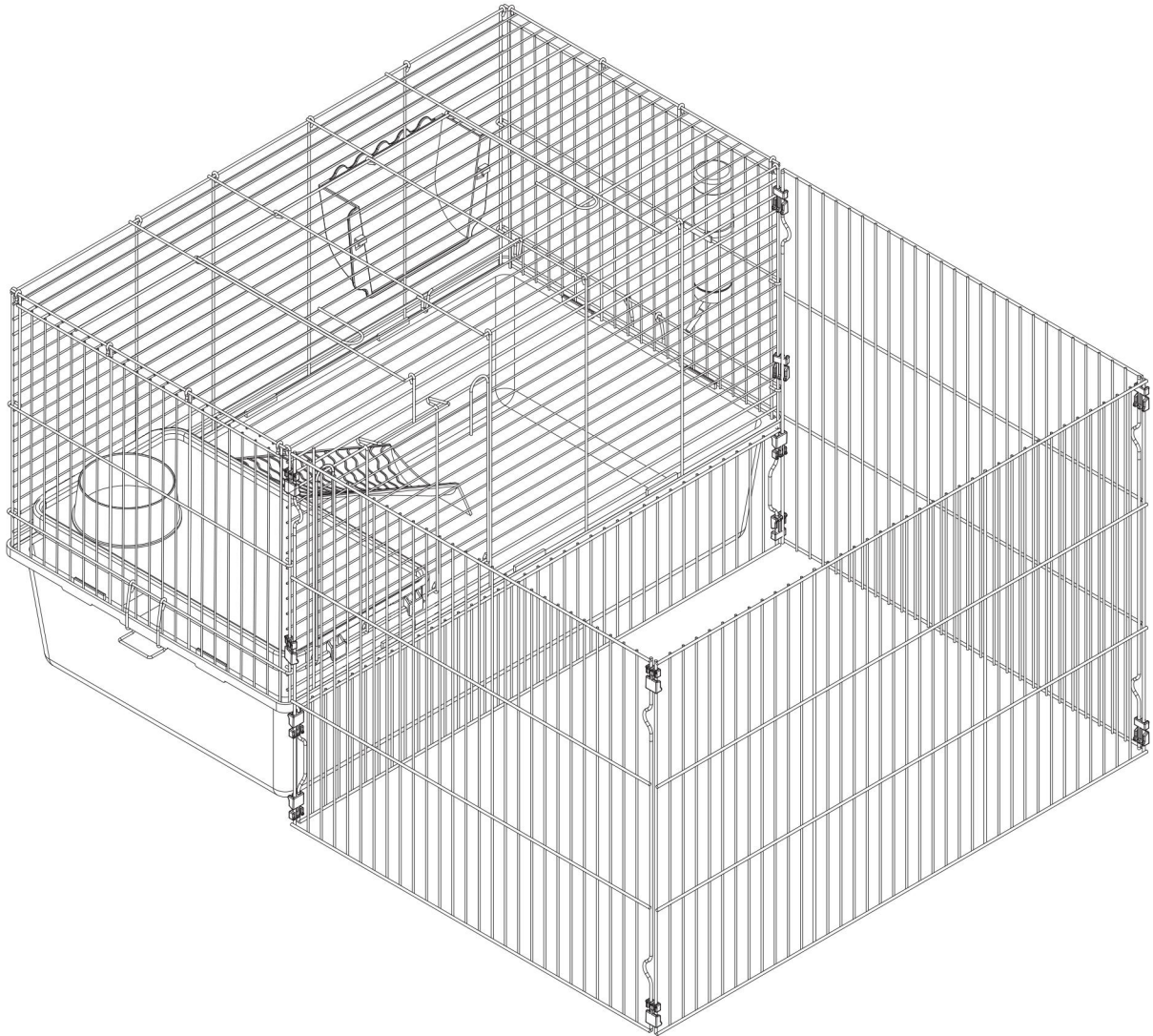

**EN\_IMPORTANT, RETAIN FOR FUTURE REFERENCE: READ CAREFULLY.**

**FR\_IMPORTANT: A LIRE ATTENTIVEMENT ET À CONSERVER POUR CONSULTATION ULTÉRIEURE.**

**ES\_IMPORTANTE, LEA Y GUARDE PARA FUTURAS REFERENCIAS.**

**PT\_IMPORTANTE, RETER PARA REFERÊNCIA FUTURA: LEIA ATENTAMENTE.**

**DE\_WICHTIG! SORGFÄLTIG LESEN UND FÜR SPÄTER NACHSCHLAGEN AUFBEWAHREN.**

**IT\_IMPORTANTE! CONSERVARE IL PRESENTE MANUALE PER FUTURO RIFERIMENTO E LEGGERLO ATTENTAMENTE.**

**EN**

**Dear customer,**

Thank you for purchasing this product. So that your appliance serves you well, please read all the instructions in this user's manual. If you have any questions, please contact our customer care center, Our contact details are below:

**FR**

**Cher client,**

Nous vous remercions d'avoir acheté ce produit. Afin que vous puissiez profiter pleinement de votre appareil, veuillez lire toutes les instructions de ce manuel d'utilisation. Si vous avez la moindre question, veuillez contacter notre centre d'assistance à la clientèle, Nos coordonnées sont les suivantes:

**DE**

**Sehr geehrter Kunde,**

Vielen Dank, dass Sie dieses Produkt erworben haben. Damit Ihr Gerät Ihnen gute Dienste leistet, lesen Sie bitte alle Hinweise in diesem Benutzerhandbuch. Wenn Sie Fragen haben, wenden Sie sich bitte an unser Kundendienstzentrum, Unsere Kontaktdaten stehen unten:

**ES**

**Queridos clientes,**

Gracias por comprar este producto. Para que su electrodoméstico le sirva mejor, lea todas las instrucciones de este manual del usuario. Si tiene alguna pregunta, comuníquese con nuestro Centro de Atención al Cliente, Nuestros datos de contacto son los siguientes:

**PT**



**Caros clientes,**

Obrigado por adquirir este produto. Para que o seu aparelho o sirva melhor, leia todas as instruções deste manual do utilizador. Se tiver alguma dúvida, por favor contacte o nosso Centro de Atendimento ao Cliente, Os nossos dados de contacto são os seguintes:

**IT**

**Caro Cliente,**

Grazie per aver acquistato questo prodotto. Per servirti meglio con questo apparecchio ti prego di leggere tutte le istruzioni in presente manuale utente. In caso di dubbio, si prega di contattare il nostro centro assistenza clienti, I nostri dettagli di contatto sono di seguito:

| Country |  Phone |  Email |
|---------|---|---|
| US      | 001-877-644-9366  | customerservice@aosom.com   |
| CA      | 416-792-6088  | customerservice@aosom.ca  |
| UK      | 0044-800-240-4004   | enquiries@mhstar.co.uk  |
| DE      | 0049-0(40)-88307530   | service@aosom.de  |
| FR      | 0033-1-84166106   | aosom@mhfrance.fr   |
| ES      | 0034-931294512  | atencioncliente@aosom.es  |
| PT      | 0034-931294512  | info@aosom.pt   |
| IT      | 0039-0249471447   | clienti@aosom.it  |

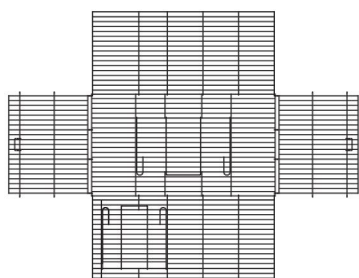

**A** x 1



**B** x 1

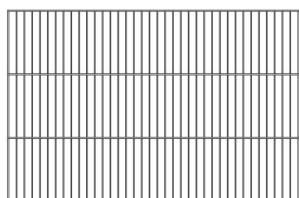

**C** x 1

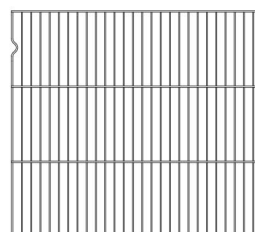

**D** x 2

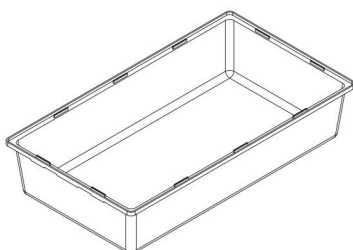

**E** x 1

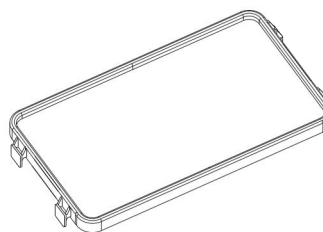

**F** x 1

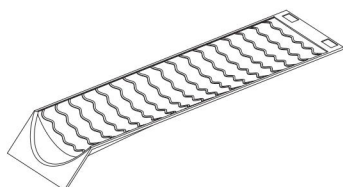

**G** x 1

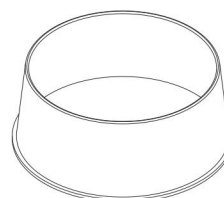

**H** x 1

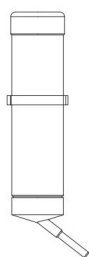

**I** x 1

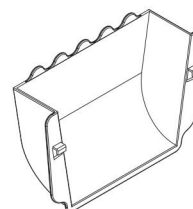

**J** x 1

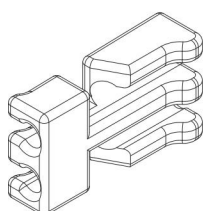

**K** x 12



01

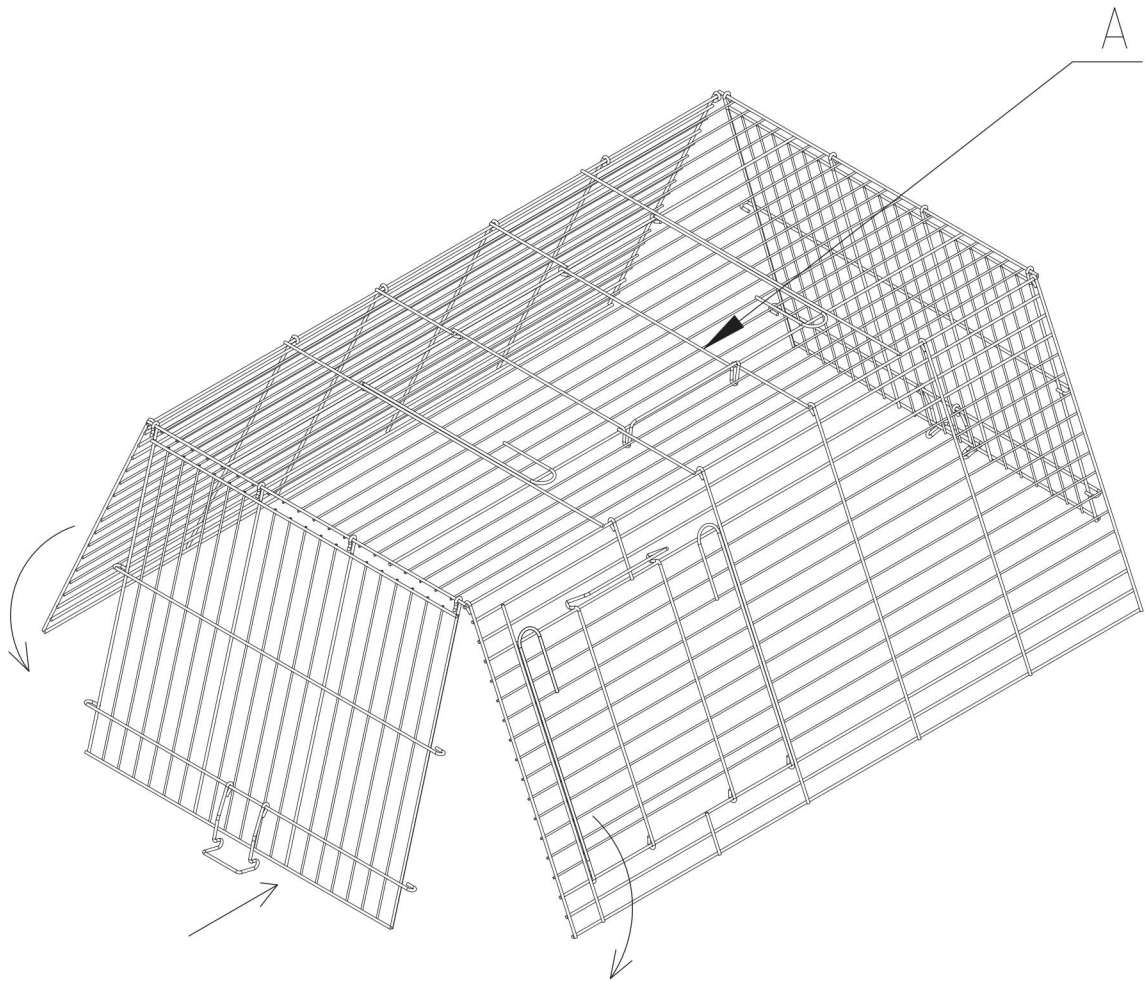

02

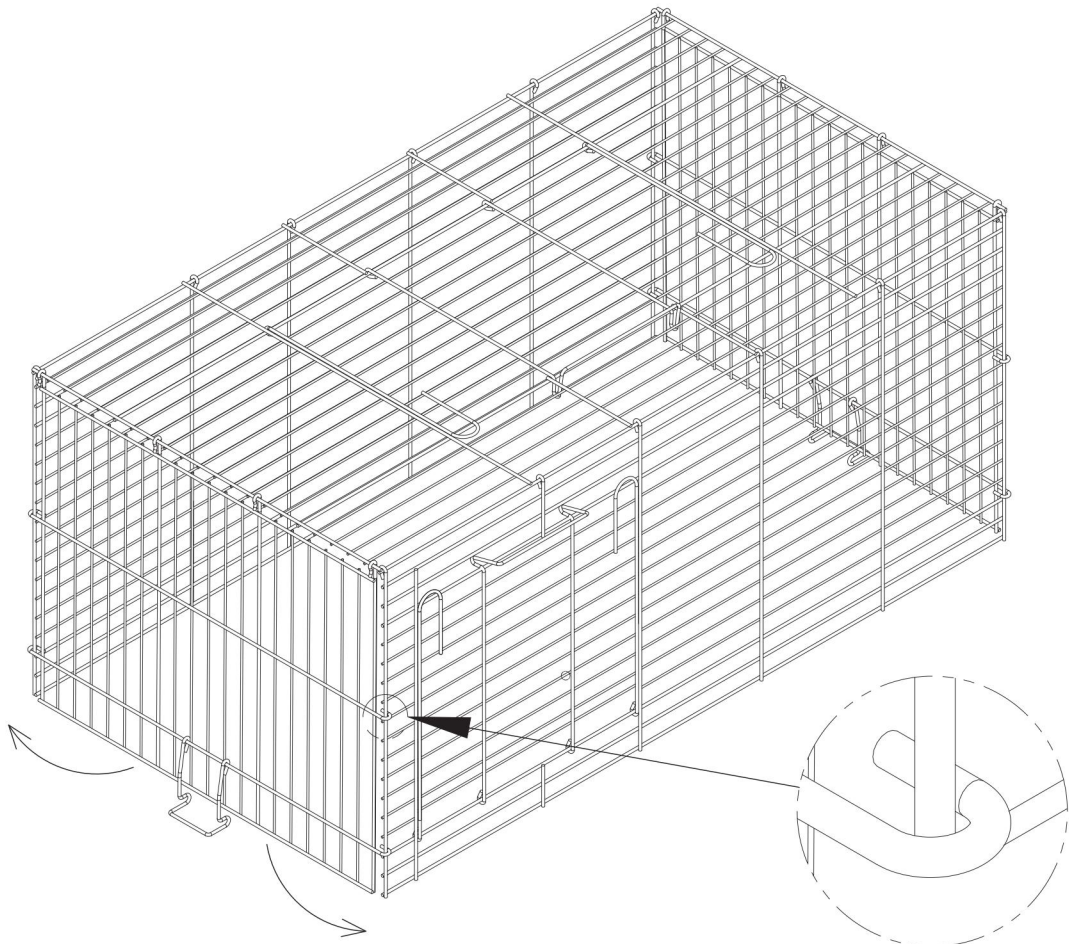



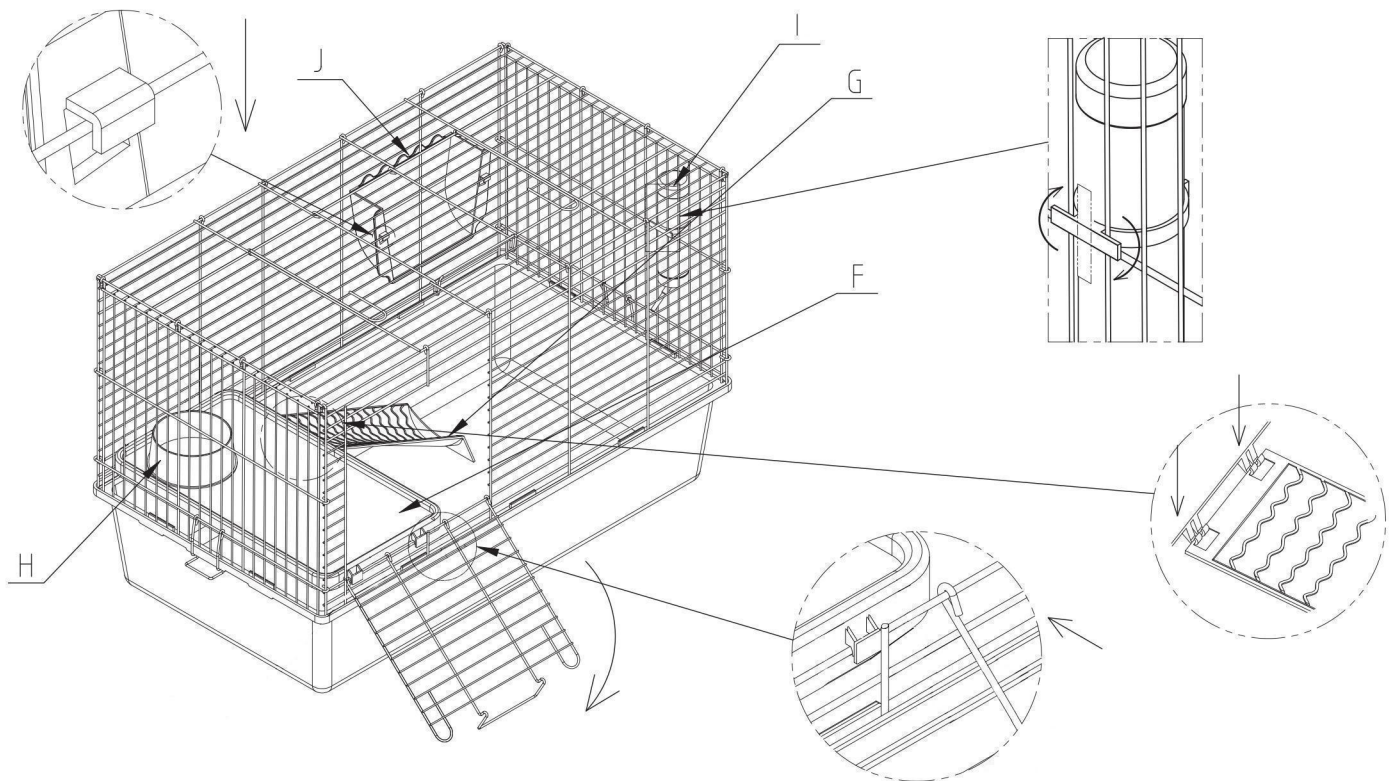
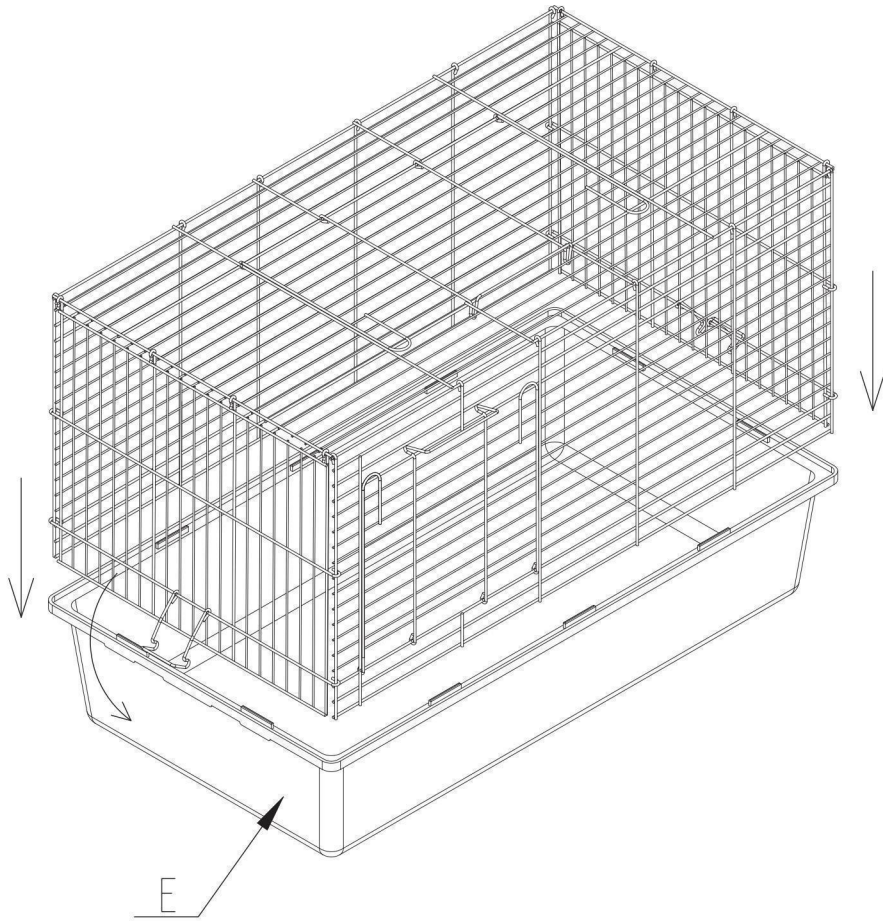

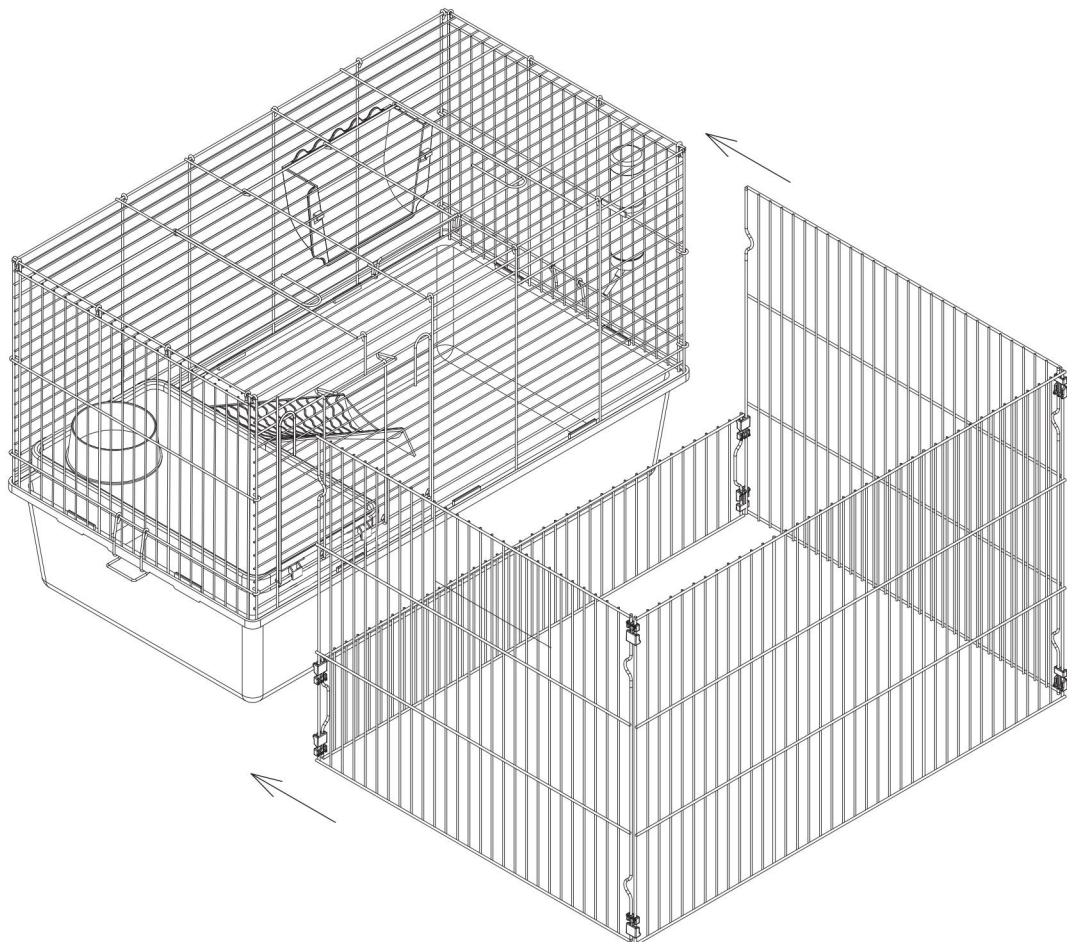
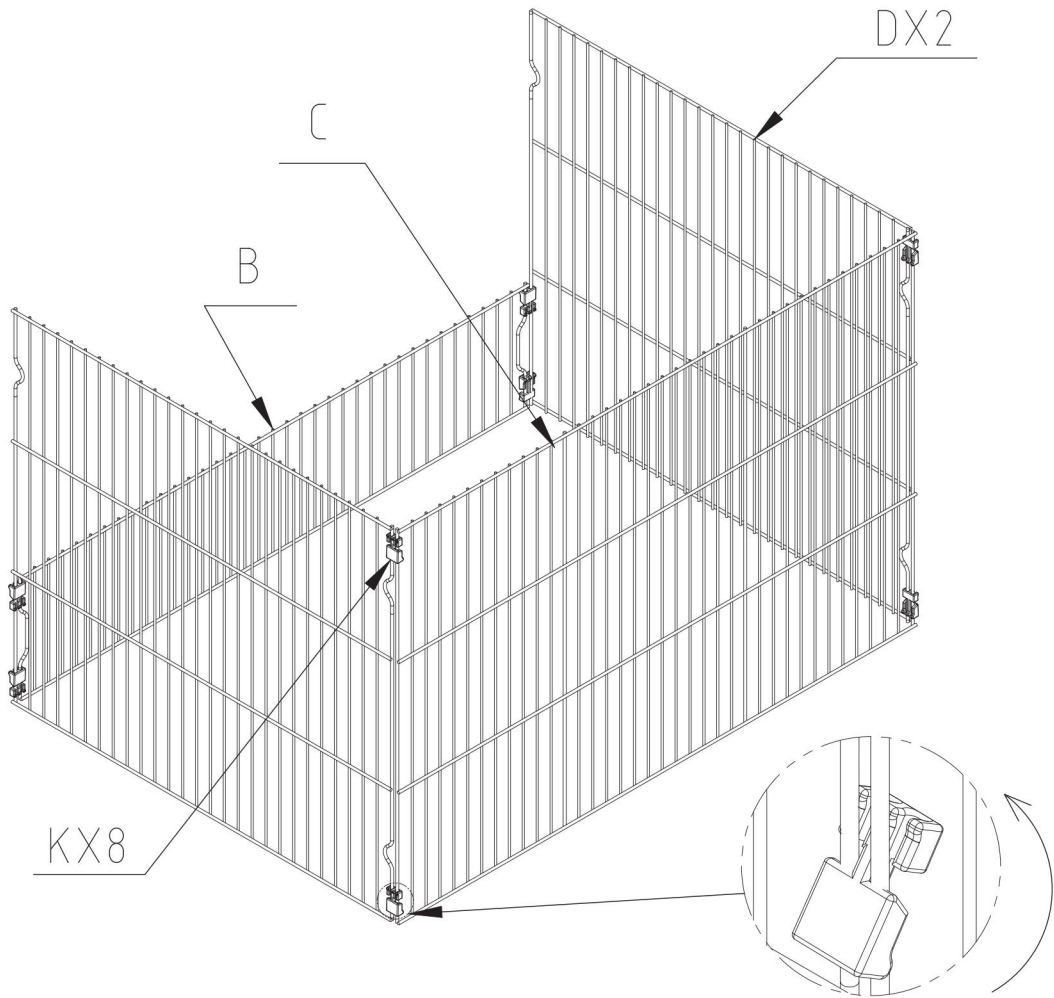



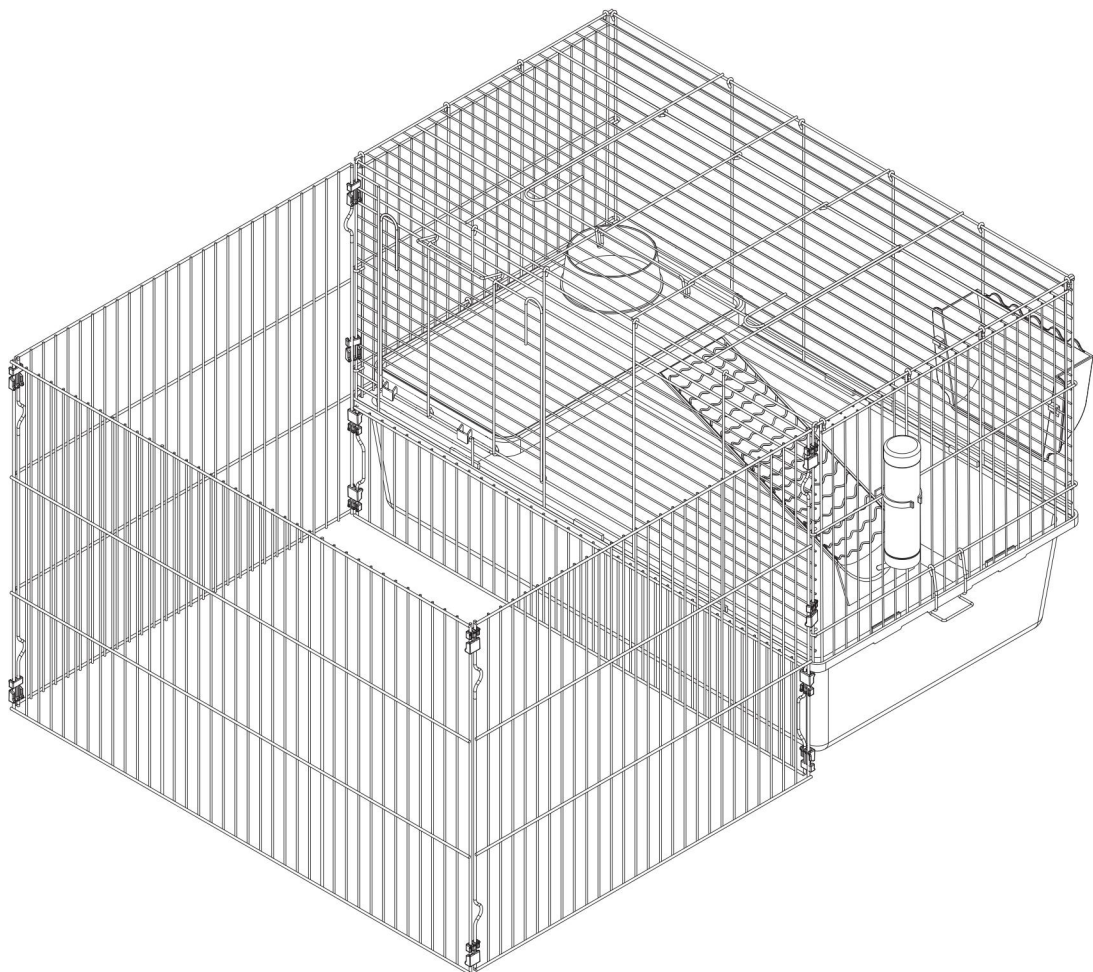
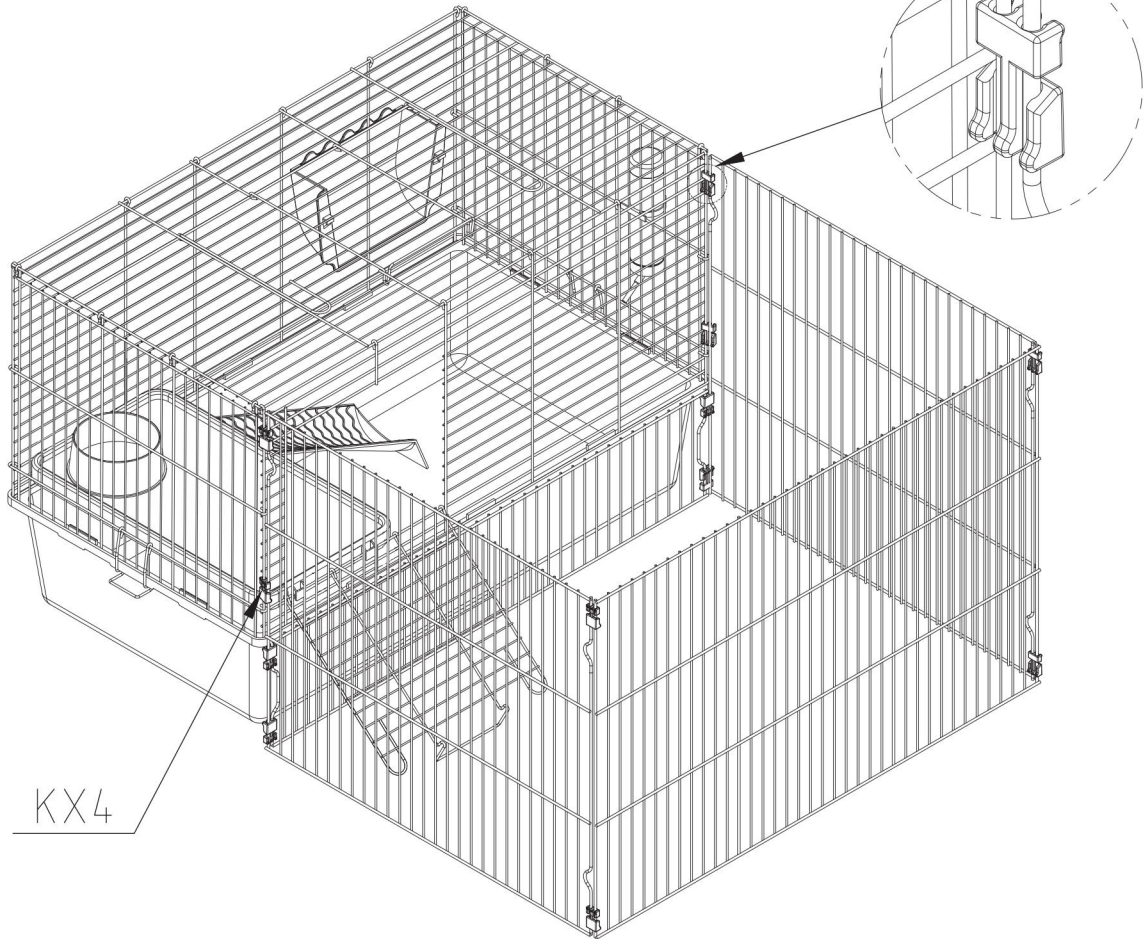



**US**

Imported by Aosom LLC  
27150 SW Kinsman Rd Wilsonville, OR 97070 USA  
MADE IN CHINA

**CA**

Imported by Aosom Canada Inc.  
7270 Woodbine Avenue, Unit 307, Markham, Ontario Canada  
L3R 4B9  
MADE IN CHINA

Importé par Aosom Canada Inc.  
7270 Woodbine Avenue, unité 307, Markham, Ontario Canada  
L3R 4B9  
Fabriqué en Chine

**UK**

IMPORTER ADDRESS:  
MH STAR UK LTD  
Unit 27, Perivale Park,  
Horsenden lane South  
Perivale, UB6 7RH  
MADE IN CHINA

**FR**

ADRESSE D'IMPORTATION:  
MH FRANCE  
2 Rue Maurice Hartmann  
92130 Issy Les Moulineaux  
France  
FABRIQUÉ EN CHINE

**ES**

IMPORTADOR:  
SPANISH AOSOM, S.L.  
C/ROC GROS,Nº15.08550, ELS HOSTALETS DE BALENYÀ, SPAIN.  
B66295775  
WWW.AOSOM.ES  
ATENCIONCLIENTE@AOSOM.ES  
TEL: 931294512  
HECHO EN CHINA

**PT**

SPANISH AOSOM, S.L  
C.ROC GROS N.15, 08550. ELS HOSTALETS DE BALENYÀ  
TEL: 931294512 (SEG-SEX DAS 7:30H ÀS 16:30H)  
INFO@AOSOM.PT  
WWW.AOSOM.PT

**DE**

ADRESSE DES IMPORTEURS:  
MH Handel GmbH  
Wendenstraße 309  
D-20537 Hamburg  
Germany  
IN CHINA HERGESTELLT

**IT**

IMPORTATO DA:  
AOSOM Italy srl  
Centro Direzionale Milanofiori  
Strada 1 Palazzo F1  
20057 Assago (MI)  
P.I.: 08567220960  
FATTO IN CINA