

EN_IMPORTANT, RETAIN FOR FUTURE REFERENCE: READ CAREFULLY.

**FR_IMPORTANT: A LIRE ATTENTIVEMENT ET À CONSERVER POUR CONSULTATION
ULTÉRIEURE.**

ES_IMPORTANTE, LEA Y GUARDE PARA FUTURAS REFERENCIAS.

DE_WICHTIG! SORGFÄLTIG LESEN UND FÜR SPÄTER NACHSCHLAGEN AUFBEWAHREN.

**IT_IMPORTANTE! CONSERVARE IL PRESENTE MANUALE PER FUTURO RIFERIMENTO E
LEggerlo ATTENTAMENTE.**

CAUTION

For indoor use only.

Keep out of reach of children and animals.

Do not use in the bathroom or damp places.

Place the lamp on a flat surface and ensure it is placed away from any flammable materials.

Before cleaning the lamp, ensure it is switched off.

Before replacing the bulb, ensure the plug has been removed from the socket and the lamp has cooled down.

Do not pull the plug out of the socket with wet hands.

If the supply cord is damaged it must only be replaced by a qualified engineer.

MISE EN GARDE

Destinée pour une utilisation a l'intérieur.

Tenir hors de portée des enfants et des animaux.

Ne pas utiliser dans la salle de bains ou dans des endroits humides.

Placez la lampe sur une surface propre et assurez-vous qu'elle soit placée à l'écart de toute matière inflammable.

Avant de nettoyer la lampe, assurez-vous qu'elle soit éteinte .

Avant de remplacer l'ampoule, vérifiez que le bouchon ait été retiré de la sortie et que la lampe se soit refroidie.

Ne tirez pas la prise avec les mains mouillées.

Si le cordon est endommagé, il doit être remplacé par un technicien qualifié.

ATTENZIONE

Solo per uso interno.

Tenere fuori dalla portata dei bambini e degli animali.

Non utilizzare in bagno o in luoghi umidi.

Posizionare la lampada su una superficie piana e accertarsi che sia posizionata lontano da qualsiasi materiale infiammabile.

Prima di pulire la lampada, assicurarsi che sia spenta.

Prima di sostituire la lampadina, assicurarsi che la spina sia stata rimossa dalla presa e che la lampada si sia raffreddata.

Non tirare la spina dalla presa con le mani bagnate.

Se il cavo di alimentazione è danneggiato, deve essere sostituito da un tecnico qualificato.

Vorsicht:

Nur für den Innengebrauch bestimmt.

Halten Sie die Lampe aus der Reichweite von Kindern und Tieren.

Stellen Sie die Lampe nicht im Badezimmer oder an feuchten Orten auf.

Stellen Sie die Lampe auf flachen Oberflächen und nicht in der Nähe von entzündlichen Materialien auf.

Bevor Sie die Lampe reinigen, stellen Sie sicher, dass diese ausgeschaltet wurde.

Stellen Sie vor dem Glühbirnenwechsel sicher, dass die Lampe von der Stromversorgung getrennt wurde und die Glühbirne abgekühlt ist.

Ziehen Sie nicht am Stecker mit nassen Händen.

Wenn das Stromversorgungskabel beschädigt wurde, darf es nur durch einen qualifizierten Elektriker gewechselt werden.

PRECAUCIÓN

Sólo para uso en interiores.

Mantener fuera del alcance de los niños y animales.

No lo use en el baño o en lugares húmedos.

Coloque la lámpara sobre una superficie limpia y asegúrese de que está colocada lejos de cualquier material inflamable.

Antes de limpiar la lámpara, asegúrese de que esté apagada.

Antes de reemplazar la bombilla, asegúrese de que el enchufe ha sido retirado de la toma y la lámpara se ha enfriado.

No tire del enchufe con las manos mojadas.

Si el cable de alimentación está dañado, sólo debe ser reemplazado por un ingeniero cualificado.

A x 1

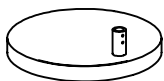

B x 3

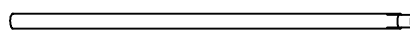

C x 1

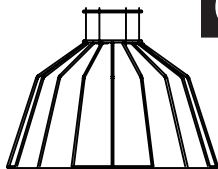

D x 1

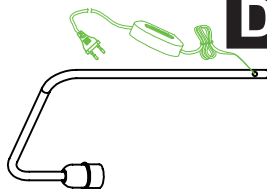

E x 1

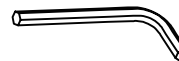

01

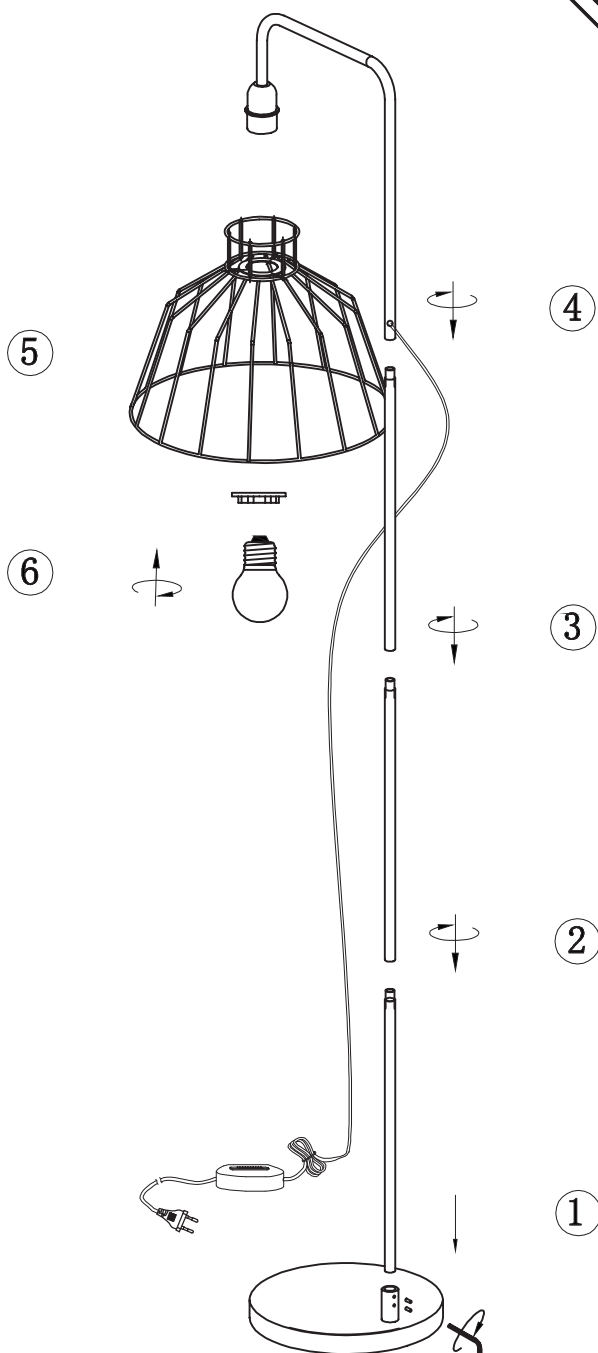

02

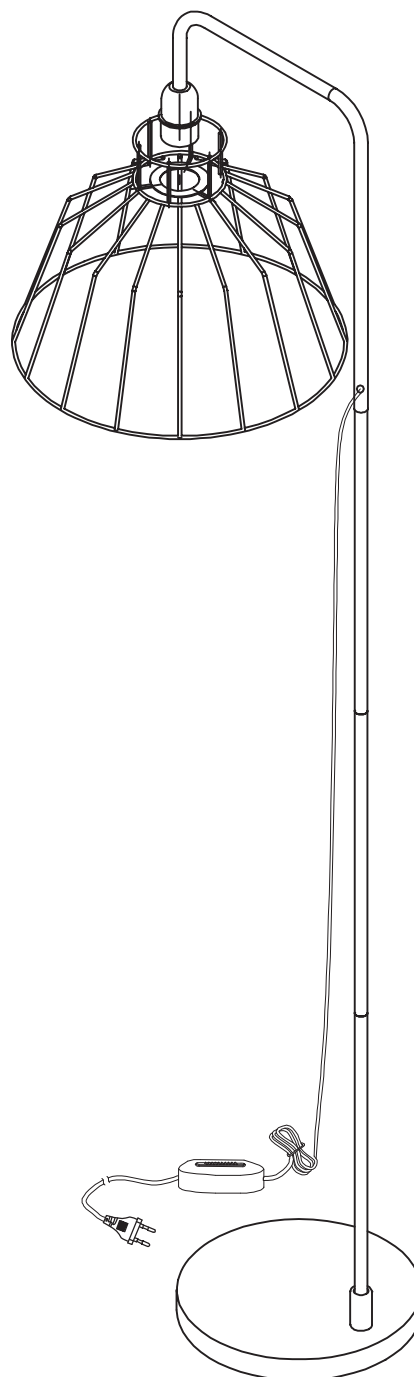

Done

UK

If you have any questions, please contact our customer care center.

Our contact details are below:



0044-800-240-4004



enquiries@mhstar.co.uk

IMPORTER ADDRESS:

MH STAR UK LTD

Unit 27, Perivale Park,

Horsenden lane South

Perivale, UB6 7RH

MADE IN CHINA

ES

Si tiene alguna pregunta, comuníquese con nuestro Centro de Atención al Cliente.

Nuestros datos de contacto son los siguientes:



0034-931294512



atencioncliente@aosom.es

IMPORTADOR:

SPANISH AOSOM, S.L.

C/ ROC GROS, N° 15. 08550, ELS HOSTALETS DE

BALENYÀ, SPAIN.

B66295775

WWW.AOSOM.ES

ATENCIONCLIENTE@AOSOM.ES

TEL: 931294512

HECHO EN CHINA

FR

Si vous avez la moindre question, veuillez contacter notre centre d'assistance à la clientèle.

Nos coordonnées sont les suivantes:



0033-1-84166106



aosom@mhfrance.fr

Importé par:

MH France

2, rue Maurice Hartmann

92130 Issy-les-Moulineaux

France

Fabriqué en Chine

PT

Se tiver alguma dúvida, por favor contacte o nosso Centro de Atendimento ao Cliente.

Os nossos dados de contacto são os seguintes:



0034-931294512



info@aosom.pt.

IMPORTADOR:

SPANISH AOSOM, S.L

C.ROC GROS N.15, 08550. ELS HOSTALETS DE BALENYÀ

TEL: 931294512 (SEG-SEX DAS 7:30H ÀS 16:30H)

INFO@AOSOM.PT

WWW.AOSOM.PT

DE

Wenn Sie Fragen haben, wenden Sie sich bitte an unser Kundendienstzentrum.

Unsere Kontaktdaten stehen unten:



0049-0(40)-88307530



service@aosom.de

ADRESSE DES IMPORTEURE:

MH Handel GmbH

Wendenstraße 309

D-20537 Hamburg

Germany

IN CHINA HERGESTELLT

IT

In caso di dubbio, si prega di contattare il nostro centro assistenza clienti.

I nostri dettagli di contatto sono di seguito:



0039-0249471447



clienti@aosom.it

IMPORTATO DA:

AOSOM Italy srl

Centro Direzionale Milanofiori

Strada 1 Palazzo F1

20057 Assago (MI)

P.I.: 08567220960

FATTO IN CINA

US

If you have any questions, please contact our customer care center.
Our contact details are below:



001-877-644-9366



customerservice@aosom.com

Imported by Aosom LLC
27150 SW Kinsman Rd Wilsonville, OR 97070 USA
MADE IN CHINA

CA

If you have any questions, please contact our customer care center.
Our contact details are below:

Si vous avez la moindre question, veuillez contacter notre centre d'assistance à la clientèle.
Nos coordonnées sont les suivantes:



416-792-6088



customerservice@aosom.ca

Imported by Aosom Canada Inc.
7270 Woodbine Avenue, Unit 307, Markham, Ontario Canada
L3R 4B9
MADE IN CHINA

Importé par Aosom Canada Inc.
7270 Woodbine Avenue, unité 307, Markham, Ontario Canada
L3R 4B9
FABRIQUÉ EN CHINE

