

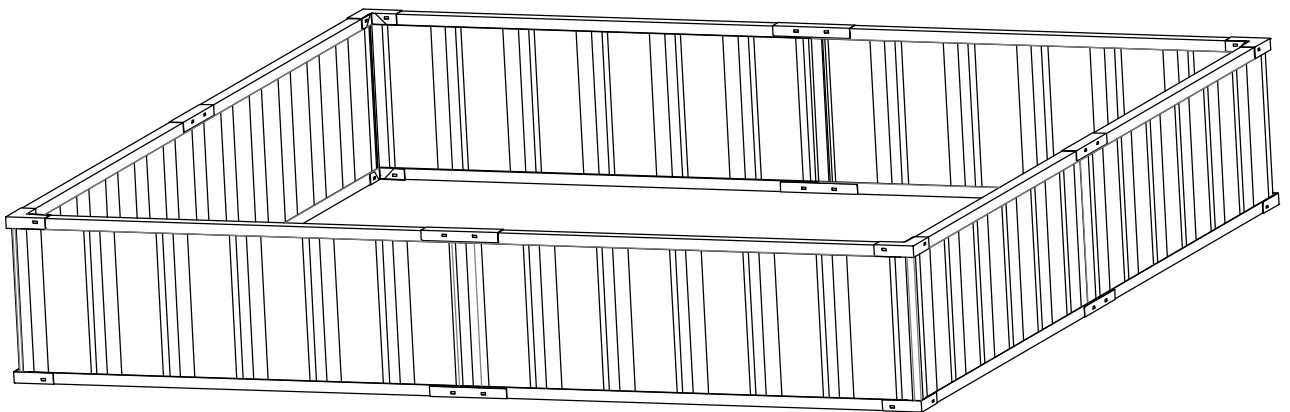

IN230800505V01_GL

845-644



EN_IMPORTANT, RETAIN FOR FUTURE REFERENCE: READ CAREFULLY.

FR_IMPORTANT: A LIRE ATTENTIVEMENT ET À CONSERVER POUR CONSULTATION ULTÉRIEURE.

ES_IMPORTANTE, LEA Y GUARDE PARA FUTURAS REFERENCIAS.

PT_IMPORTANTE, RETER PARA REFERÊNCIA FUTURA: LEIA ATENTAMENTE.

DE_WICHTIG! SORGFÄLTIG LESEN UND FÜR SPÄTER NACHSCHLAGEN AUFBEWAHREN.

IT_IMPORTANTE! CONSERVARE IL PRESENTE MANUALE PER FUTURO RIFERIMENTO E LEGGERLO ATTENTAMENTE.

EN

Dear customer,

Thank you for purchasing this product. So that your appliance serves you well, please read all the instructions in this user's manual. If you have any questions, please contact our customer care center, Our contact details are below:

FR

Cher client,

Nous vous remercions d'avoir acheté ce produit. Afin que vous puissiez profiter pleinement de votre appareil, veuillez lire toutes les instructions de ce manuel d'utilisation. Si vous avez la moindre question, veuillez contacter notre centre d'assistance à la clientèle, Nos coordonnées sont les suivantes:

DE

Sehr geehrter Kunde,

Vielen Dank, dass Sie dieses Produkt erworben haben. Damit Ihr Gerät Ihnen gute Dienste leistet, lesen Sie bitte alle Hinweise in diesem Benutzerhandbuch. Wenn Sie Fragen haben, wenden Sie sich bitte an unser Kundendienstzentrum, Unsere Kontaktdaten stehen unten:

ES

Queridos clientes,

Gracias por comprar este producto. Para que su electrodoméstico le sirva mejor, lea todas las instrucciones de este manual del usuario. Si tiene alguna pregunta, comuníquese con nuestro Centro de Atención al Cliente, Nuestros datos de contacto son los siguientes:

PT

Caros clientes,

Obrigado por adquirir este produto. Para que o seu aparelho o sirva melhor, leia todas as instruções deste manual do utilizador. Se tiver alguma dúvida, por favor contacte o nosso Centro de Atendimento ao Cliente, Os nossos dados de contacto são os seguintes:

IT

Caro Cliente,

Grazie per aver acquistato questo prodotto. Per servirti meglio con questo apparecchio ti prego di leggere tutte le istruzioni in presente manuale utente. In caso di dubbio, si prega di contattare il nostro centro assistenza clienti, I nostri dettagli di contatto sono di seguito:

Country	 Phone	 Email
US	001-877-644-9366	customerservice@aosom.com
CA	416-792-6088	customerservice@aosom.ca
UK	0044-800-240-4004	enquiries@mhstar.co.uk
DE	0049-0(40)-88307530	service@aosom.de
FR	0033-1-84166106	aosom@mhfrance.fr
ES	0034-931294512	atencioncliente@aosom.es
PT	0034-931294512	info@aosom.pt
IT	0039-0249471447	clienti@aosom.it

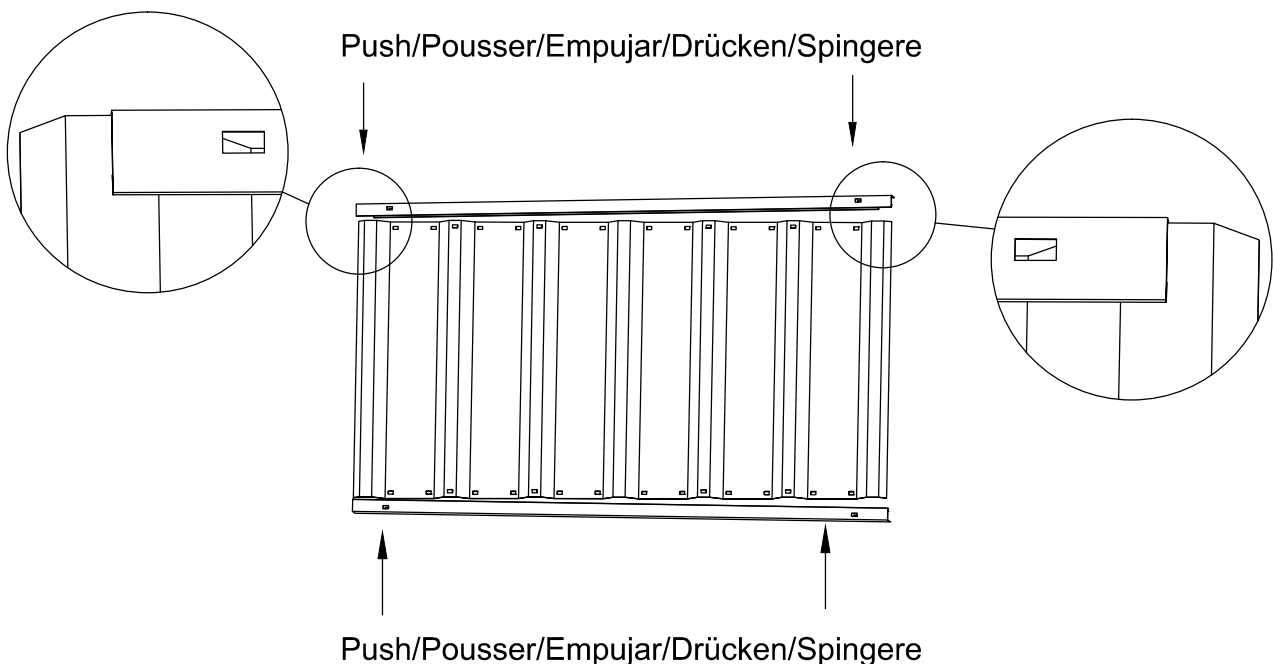
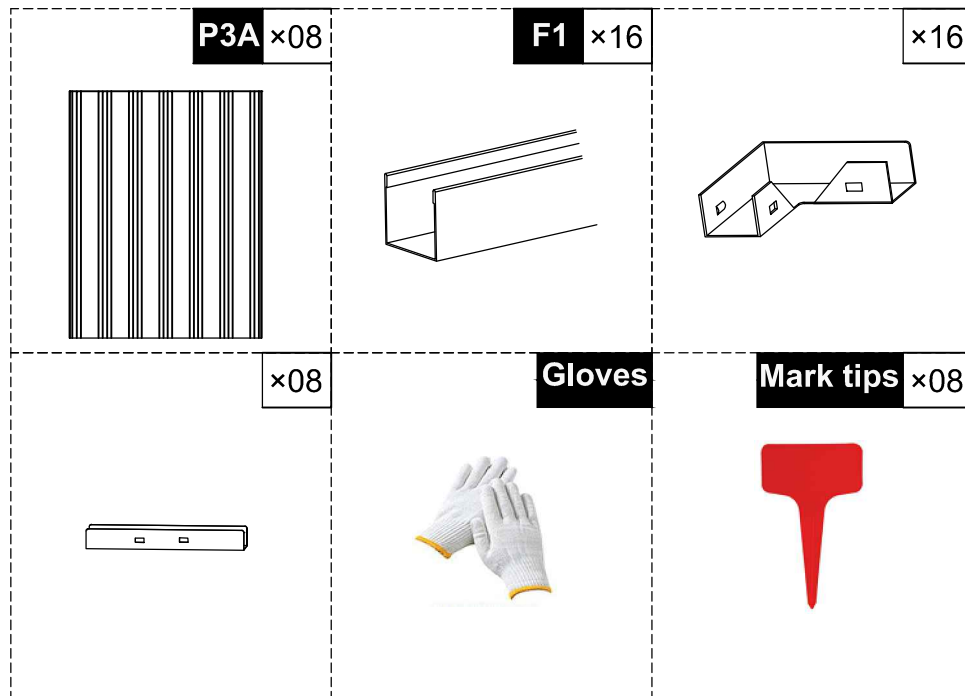

EN Install the card frame on the sheet by one side to the other side; make sure the card frame connected with the sheet completely.

FR Installez le cadre de la carte sur la feuille d'un côté à l'autre ; assurez-vous que le cadre de la carte est complètement connecté à la feuille.

ES Instale el marco de tarjeta en la hoja de un lado al otro; asegúrese de que el marco de tarjeta esté conectado con la hoja completamente.

DE Installieren Sie den Kartenrahmen auf dem Blatt von einer Seite zur anderen; stellen Sie sicher, dass der Kartenrahmen vollständig mit dem Blatt verbunden ist.

IT Installare il telaio della scheda sul laminato passando da un lato all'altro; assicurarsi che il telaio sia completamente collegato al laminato.

Push/Pousser/Empujar/Drücken/Spingere

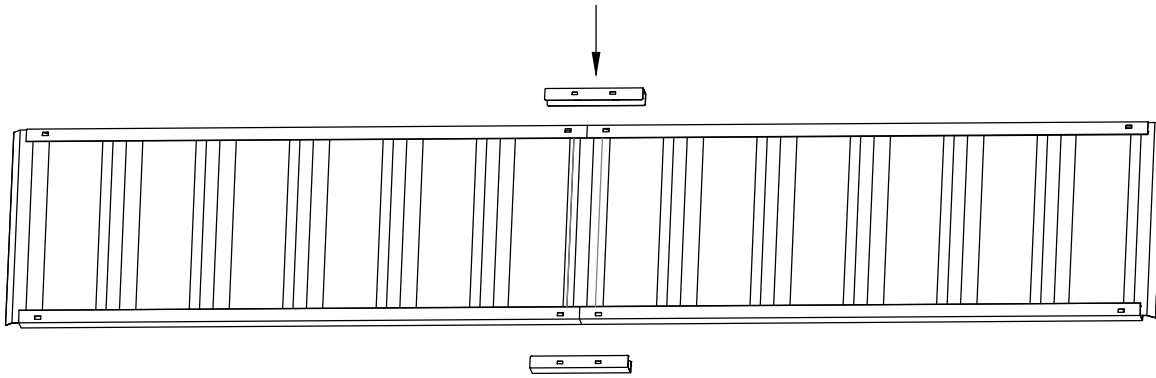

EN Adjust the card frame , card frame should be installed in the middle of each sheet; Install frame connect, do remember to align the holes before push.

FR Ajustez le cadre de la carte : le cadre de la carte doit être installé au milieu de chaque feuille ; installez la connexion du cadre, n'oubliez pas d'aligner les trous avant de pousser.

ES Ajuste el marco de tarjeta. Y el marco de tarjeta debe ser instalado en el medio de cada hoja; instale el conector de marco, recuerde alinear los orificios antes de empujarlo.

DE Richten Sie den Kartenrahmen aus, der Kartenrahmen sollte in der Mitte jedes Blattes installiert werden; verbinden Sie den Rahmen, denken Sie daran, die Löcher vor dem Drücken auszurichten.

IT Regolare il telaio della scheda, esso deve essere installato al centro di ogni laminato, installare il connettore del telaio, ricordarsi di allineare i fori prima di spingere.

EN Push corner connector to fix the four corners.

FR Poussez le connecteur d'angle pour fixer les quatre coins.

ES Empuje el conector de esquina para fijar las 4 esquinas bien.

DE Drücken Sie die Eckverbinder, um die vier Ecken zu fixieren.

IT Spingere il connettore angolare per fissare in posizione i quattro angoli.

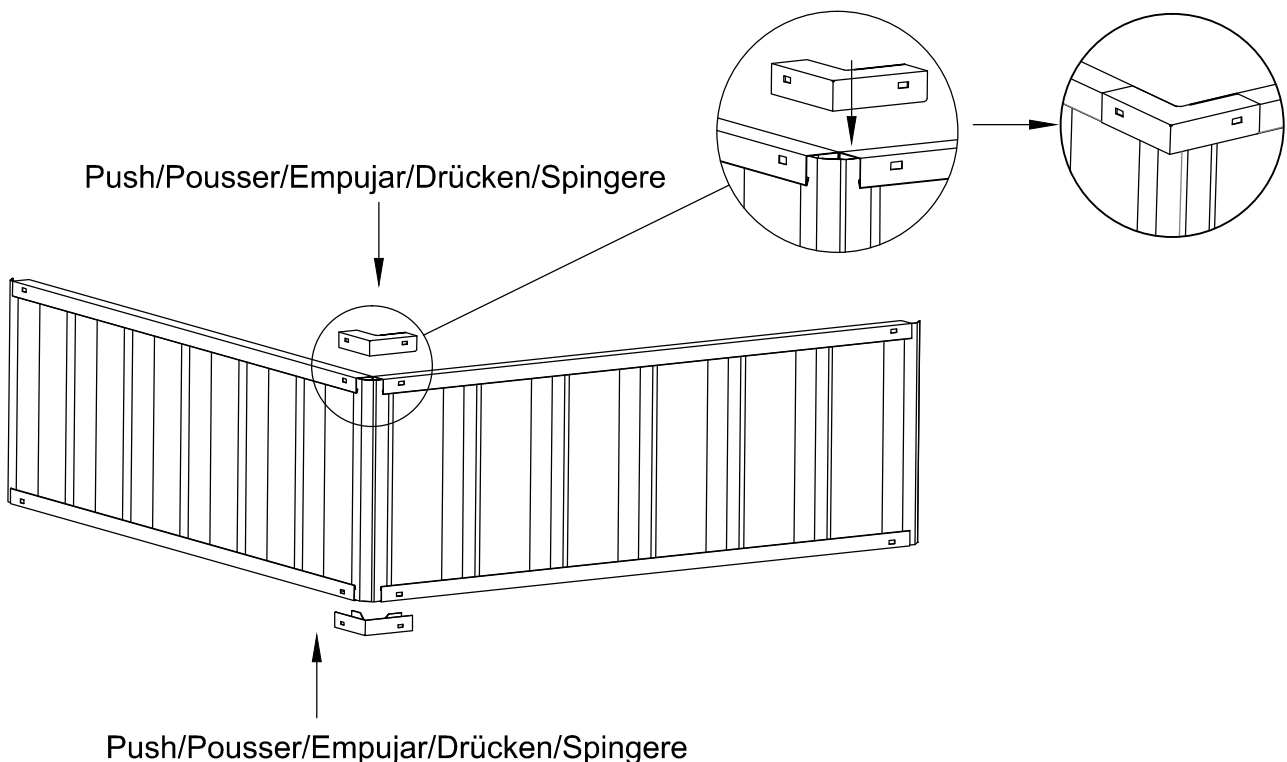

INSTALLATION METHOD 1

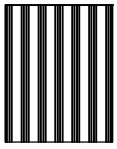

8 PCS

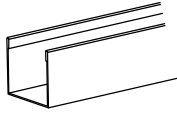

16 PCS

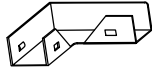

8 PCS

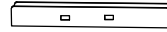

8 PCS

Size: L258 x W90 x H30 cm

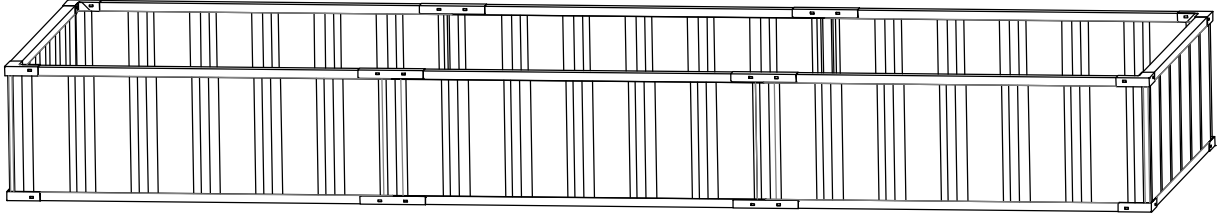

INSTALLATION METHOD 2

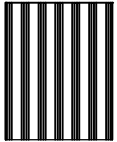

6 PCS

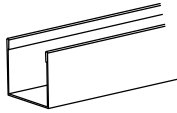

12 PCS

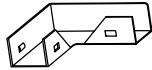

8 PCS

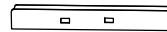

4 PCS

Size: L174 x W90 x H30 cm

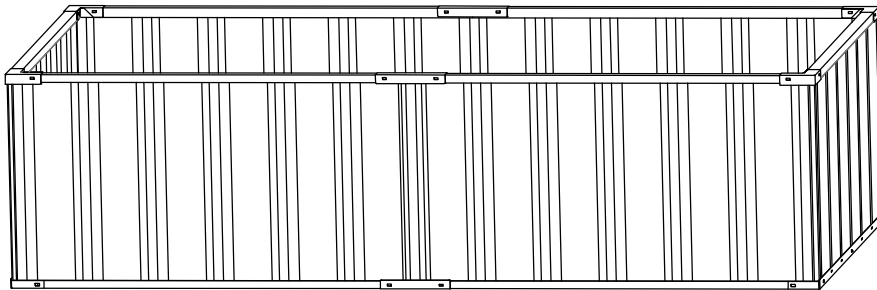

INSTALLATION METHOD 3

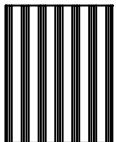

8 PCS

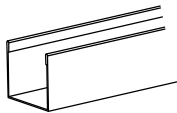

16 PCS

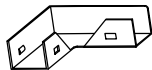

8 PCS

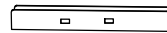

8 PCS

Size: L174 x W174 x H30 cm

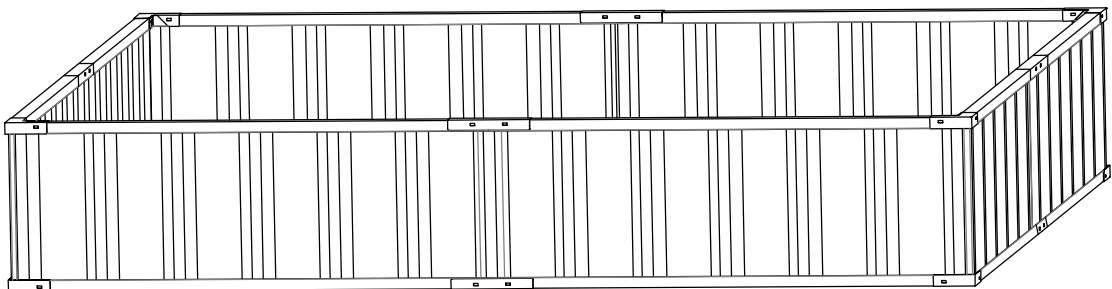

INSTALLATION METHOD 4

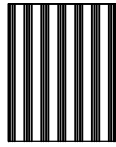

4 PCS

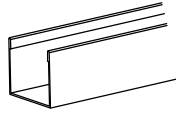

8 PCS

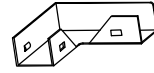

8 PCS

Size: L90 x W90 x H30 cm

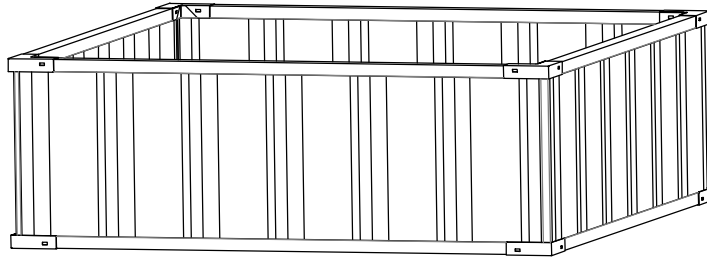

x2

INSTALLATION METHOD 5

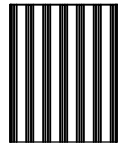

8 PCS

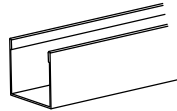

16 PCS

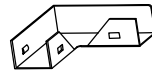

12 PCS

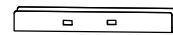

4 PCS

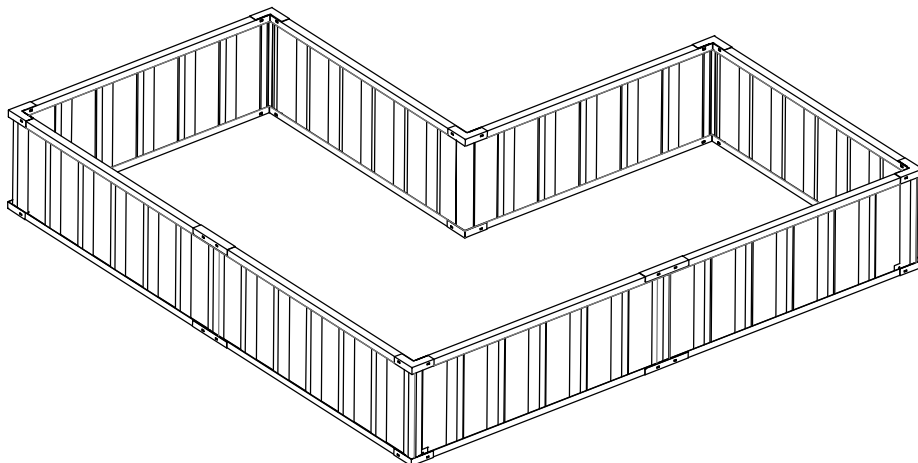

US

Imported by Aosom LLC
27150 SW Kinsman Rd Wilsonville, OR 97070 USA
MADE IN CHINA

CA

Imported by Aosom Canada Inc.
7270 Woodbine Avenue, Unit 307, Markham, Ontario Canada
L3R 4B9
MADE IN CHINA

Importé par Aosom Canada Inc.
7270 Woodbine Avenue, unité 307, Markham, Ontario Canada
L3R 4B9
Fabriqué en Chine

UK

IMPORTER ADDRESS:
MH STAR UK LTD
Unit 27, Perivale Park,
Horsenden lane South
Perivale, UB6 7RH
MADE IN CHINA

FR

ADRESSE D'IMPORTATION:
MH FRANCE
2 Rue Maurice Hartmann
92130 Issy Les Moulineaux
France
FABRIQUÉ EN CHINE



Adresses sur quefairedemesdechets.fr

ES

IMPORTADOR:
SPANISH AOSOM, S.L.
C/ROC GROS, Nº15.08550, ELS HOSTALET DE BALENYÀ, SPAIN.
B66295775
WWW.AOSOM.ES
ATENCIONCLIENTE@AOSOM.ES
TEL: 931294512
HECHO EN CHINA

PT

SPANISH AOSOM, S.L
C.ROC GROS N.15, 08550. ELS HOSTALET DE BALENYÀ
TEL: 931294512 (SEG-SEX DAS 7:30H ÀS 16:30H)
INFO@AOSOM.PT
WWW.AOSOM.PT

DE

ADRESSE DES IMPORTEURE:
MH Handel GmbH
Wendenstraße 309
D-20537 Hamburg
Germany
IN CHINA HERGESTELLT

IT

IMPORTATO DA:
AOSOM Italy srl
Centro Direzionale Milanofiori
Strada 1 Palazzo F1
20057 Assago (MI)
P.I.: 08567220960
FATTO IN CINA