



IN230800508V01_UK

A71-007_A71-007V01



IMPORTANT, RETAIN FOR FUTURE REFERENCE: READ CAREFULLY

ASSEMBLY & INSTRUCTION MANUAL

Fitness Trampoline

Parts list

			
TR01 x 1pcs	TR02 x 8pcs	TR03 x 1pcs	TR04 x 1pcs
			
TR05 x 1pcs	TR06 x 1pcs	TR07 x 1pcs	TR08 x 1pcs
			
TR09 x 2pcs	TR10 x 1pcs	TR11 x 1pcs	TR12 x 2pcs
			
TR13 x 2pcs			

Installation

Safety instructions for installation and assembly.

- Assemble the trampoline with sufficient space to move in.
- Protect your floor with a tarpaulin, cover, sheet or similar.
- Read these instructions carefully before installation.

Step 1

Lay the trampoline on the floor, in its still folded position (image 1). Push out the ends according to the arrows on the picture, so the rebounder expands and looks like a half moon (image2).

WARNING: The trampoline needs to be open by two adults! And adjust the gap between the elastic ropes evenly after open.

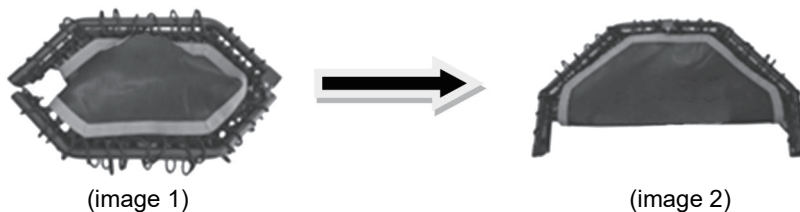

Step 2

Using steady pressure with hands open and finger extended, use palm of hands to push top side of frame up, over and down to open position.

WARNING: Frame will snap close, FIX the Trampoline with Safety Screws thus it will not snap close!!!! The Snap Back will be Dangerous!!!

Please keep all fingers away from hinge when opening and closing!!!!

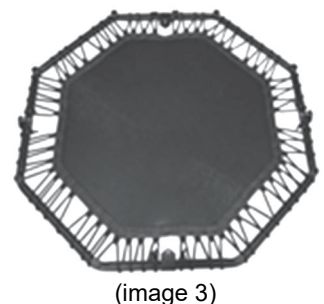

Step 3

Install the safety screws on the hinge (image4), so the trampoline does not fold while in use .



(image 4)



Step 4

With the trampoline now open and still upside down, install all 8 legs

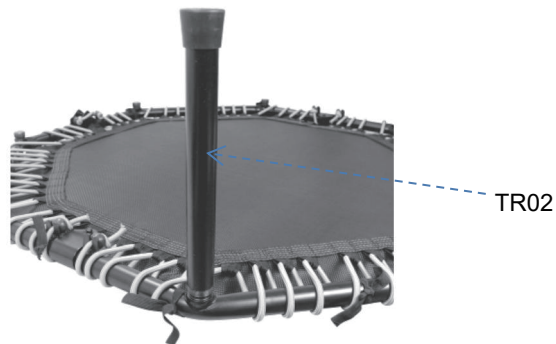

Step 5

Attention: There is a hole at center of the frame tube, before installing the bottom connect bar, please find the hole first (as shown A).

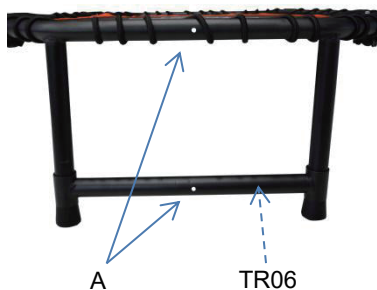

Please find out bottom bar(TR06), To install on two legs, first remove rubber "feet" from these 2 legs, as shown B and C, Fix the bottom BarTR06 with Two TR12 screws with help of Allen Key TR08, then recap rubber feet.

Step 6

Now connect the trampoline frame (TR01) and Bottom Bar (TR06) with the handle bar OUTER (TR05) by two long screws (TR09)

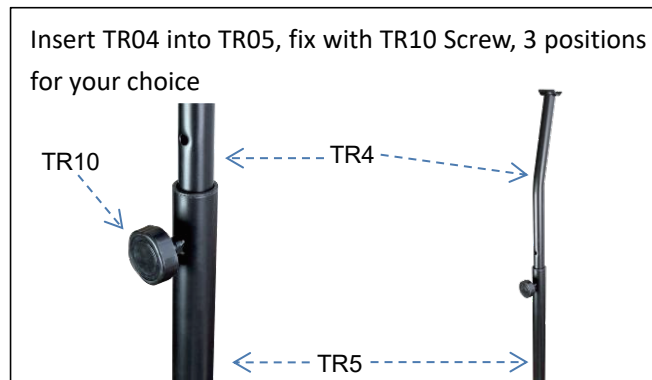
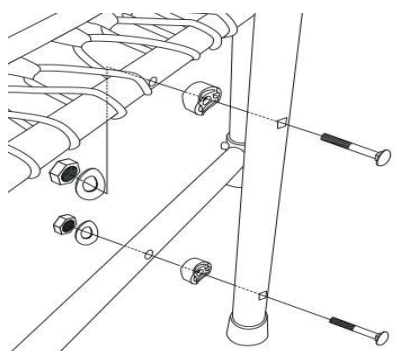

Step 7

Then install the Top bar (TR03) and inner bar (TR04) by screws, connect all parts as the picture shows.



CLOSING UP INSTRUCTIONS

IMPORTANT SAFETY NOTE: Always close your trampoline with 2 people.

- Turn the unit upside down and lay it flat.
- Take each leg out.
- Locate the larger hinges on each side of the trampoline. Stand near the hinges on opposite sides of the trampoline facing the upper half of the frame

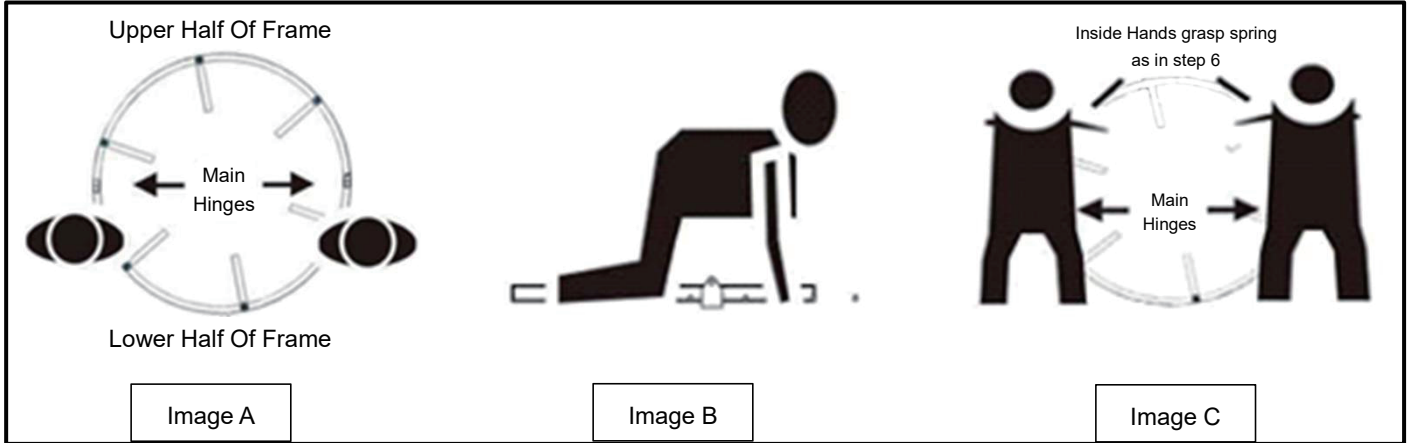

- Both persons kneel facing the “top half” of the trampoline and place their knee closest to the trampoline on the “bottom half” of the frame approximately 2 inches below (not on) the hinge (Image B).
- Both persons lean forward placing their outside hand on the ground and use their inside hand to grasp one of the spring ropes near the top of the trampoline (image C)
- Together pull gently on the spring ropes and the top half of the frame will rise toward the middle. Ensure that your head is clear of moving frame

Note: Watch out for your hands, feet body part, etc. And always take 2 people to fold the trampoline

Instructions for Use

- Make sure to check that all screws are tightened each time before using the trampoline, and that the handlebar is set at the correct height and that it is fixed to the frame. Additionally, check that the jumping mat has tension, that the 36 elastic ropes are in good condition, and that they are looped to the plastic hooks.
- Pay attention to damages and gradual wear and tear.
- Consult a doctor before using the trampoline if: You have not participated or performed much athletic activities recently, have high-risk health complications, heart or orthopedic problems, or if you are pregnant.
- First become familiar with your trampoline: Begin your workout slowly. Start with small bounces and increase your intensity gradually to higher jumps. Always maintain control. The risk of damages increases with excessive or improper use.
- The trampoline is intended for use by persons who are fit and healthy. Do not use the trampoline after consuming food, alcoholic beverages or narcotic substances. If you become dizzy or nauseous, have heart-related problems or other health issues, stop training immediately and contact a doctor.
- This equipment is intended for fitness exercises like bouncing, light jumps, walking and jogging. Do not jump aggressively; otherwise, you risk injuries to your head or neck.
- Prepare yourself for training with a warm-up, and always cool down at the end of a workout. If you do not, you may feel discomfort in your back muscles.
- Stay hydrated and take sufficient breaks to avoid fatigue or injuries.
- Never exercise when tired, exhausted or lacking concentration; otherwise, you risk injury.
- Do not jump on and off the mat. Always mount and dismount with care.
- Jump in the middle of the mat only; take care to not jump or step on the edge cover or frame.

Storage and Care

- Clean your trampoline with warm water and mild soap only. Do not use aggressive detergents or soaps; these can cause serious damages to the mat.
- When storing, remove the feet and the handlebar to save space. Take care when reattaching these parts to tighten their locks and screws before use.
- Store the trampoline out of reach of children and animals.
- Store the trampoline in a space with consistent temperatures; not where it would be subject to extreme temperature fluctuations, direct sunlight or moisture.

Using the Trampoline

- The maximum body weight of the user should not exceed 100 kg.
- This trampoline is intended for use as a home training device in the private sector (class H). It is not intended for commercial, medical or therapeutic purposes. This equipment is suitable for use as a fitness trampoline only. The use of the trampoline is allowed only as described in this manual. Another use of the trampoline is illegal and may cause damages. Please be aware that improper and excessive use of the trampoline can lead to damages. We are not responsible for damages resulting from improper use, wear and tear, or repair attempts by the user.

Health Hazards

- This equipment is not intended as a child's toy, and can be used by persons aged from 14 years and above. Children should be supervised to ensure that they do not play with the trampoline or packaging material. Children should be under supervision when allowed to jump on the trampoline.
- Only one person is permitted to use the trampoline at a time. No objects or animals can be under, above or next to equipment when the trampoline is in use.
- This equipment is not intended for use by persons (including children) with reduced physical, sensory or mental capabilities, or lack of experience and knowledge, unless they have been given supervision or instruction concerning use of the trampoline by a person responsible for their safety. If you are in doubt, please consult a doctor before use.
- Consult a doctor before using the trampoline if: You have not participated or performed much athletic activities recently, have high-risk health complications, heart or orthopedic problems, or if you are pregnant.
- Prepare yourself for training with a warm-up. Proper attire should be worn while using the trampoline: comfortable sports shoes and sportswear. Avoid wearing shoes with a hard sole or strong platform as they can quickly wear down or ruin the jumping mat.
- Do not wear loose clothing to avoid getting material caught on the handlebar. Train with the trampoline in a well-ventilated room.
- Begin your workout slowly and increase your intensity gradually. The risk of damages is possible with excessive or improper use. Do not use the trampoline after consuming food, alcoholic beverages or narcotic substances. The trampoline is intended for use by persons who are fit and healthy. If you become dizzy or nauseous, have heart-related problems or other health issues, stop training immediately and contact a doctor.

Safety Instructions for Installation

- Install this trampoline on a solid, flat, clean and non-slip surface. Parquet or other sensitive floor materials may need to be covered.
- You can use this equipment indoors and outdoors! Your trampoline is made of stainless steel or powder-coated steel and does not rust.
- If possible, set up the ropes with two people.
- The trampoline must not be used in rooms with low ceilings. When jumping, your head should not hit the ceiling or other items.

- Give yourself at least one meter/three feet of space around you while training on the trampoline. The training area must be accessible from all sides in order to ensure that you can leave the trampoline in case of an emergency.
- Keep the trampoline away from heat, such as a furnace or open fireplace.
- This training equipment should not be subjected to extreme temperature fluctuations between hot and cold, or exposed to direct sunlight, and moisture should be avoided.

Safety Instructions for Use

- Before every use of the trampoline, check that all equipment parts are in perfect condition and free from damage. Check the trampoline regularly for damages and defects, and inspect parts damages acquired in transportation, such as loose connections, cracks or holes. If damages or defects are discovered, do not use the equipment. Safe training with this equipment is only possible with an intact trampoline.
- Repairs or replacements of defective or damaged parts must be accomplished by a specialist only. Do not repair or fix the trampoline yourself; otherwise, the warranty is made obsolete.
- To use the trampoline, the frame and jumping mat must be tightly connected with a complete set of 36 elastic ropes under tension.
- The height of the handlebar is adjustable. Before jumping on the trampoline, adjust the handlebar for your height, and secure the rod with the locking screw.
- The handlebar is designed to help you stay balanced while jumping. Do not lean against the handlebar with your bodyweight; otherwise, you risk tilting the trampoline.
- Be careful that clothing, hair or the like are not caught on the supporting rod or handlebar.
- Do not attach anything to the trampoline.
- The intended use of this is equipment is for training and fitness exercises only, such as bouncing, walking, jogging and light jumping. Do not jump over the trampoline, otherwise the risk for injuries and damages to your head or neck increase.
- Improper and unsafe jumping can lead to serious injury! Do not jump on or off the trampoline, instead, step on and step off carefully.
- Bounce gently to become familiar with your trampoline, and gradually increase your jumping intensity once you are comfortable. Jump with care and stay in control of your movements at all times.
- Jump in the middle of the mat, and avoid jumping on the outside ring near the elastic ropes.
- Never jump on the edge of the jumping mat or the frame.

Before First Use

- Before assembling your new trampoline, unpack the parts and check that all pieces are in perfect condition.
-  Keep the packing material and single-piece items away from children and animals. Leaving them unattended increases the risk of swallowing items and suffocation!
- Unpack the pieces and remove the cardboard, foil and plastic parts. Compare the contents of the trampoline box with small parts (TR07 to TR13 in parts list) to confirm that all pieces are present. Before assembling, check that all parts are in mint condition and free of damages or defects. If you find defective or faulty parts, do not assemble the trampoline. Instead, contact customer service.

Specifications

Please contact us if you discover missing or defective parts. It's recommended that you install this trampoline with two people. Take care to keep your head and face away from the frame to avoid injuries.

UK

If you have any questions, please contact our customer care center.

Our contact details are below:



0044-800-240-4004



enquiries@mhstar.co.uk

IMPORTER ADDRESS:

MH STAR UK LTD

Unit 27, Perivale Park,

Horsenden lane South

Perivale, UB6 7RH

MADE IN CHINA

ES

Si tiene alguna pregunta, comuníquese con nuestro Centro de Atención al Cliente.

Nuestros datos de contacto son los siguientes:



0034-931294512



atencioncliente@aosom.es

IMPORTADOR:

SPANISH AOSOM, S.L.

C/ ROC GROS, N° 15. 08550, ELS HOSTALETS DE

BALENYÀ, SPAIN.

B66295775

WWW.AOSOM.ES

ATENCIONCLIENTE@AOSOM.ES

TEL: 931294512

HECHO EN CHINA

FR

Si vous avez la moindre question, veuillez contacter notre centre d'assistance à la clientèle.

Nos coordonnées sont les suivantes:



0033-1-84166106



aosom@mhfrance.fr

Importé par:

MH France

2, rue Maurice Hartmann

92130 Issy-les-Moulineaux

France

Fabriqué en Chine

PT

Se tiver alguma dúvida, por favor contacte o nosso Centro de Atendimento ao Cliente.

Os nossos dados de contacto são os seguintes:



0034-931294512



info@aosom.pt.

IMPORTADOR:

SPANISH AOSOM, S.L

C.ROC GROS N.15, 08550. ELS HOSTALETS DE BALENYÀ

TEL: 931294512 (SEG-SEX DAS 7:30H ÀS 16:30H)

INFO@AOSOM.PT

WWW.AOSOM.PT

DE

Wenn Sie Fragen haben, wenden Sie sich bitte an unser Kundendienstzentrum.

Unsere Kontaktdaten stehen unten:



0049-0(40)-88307530



service@aosom.de

ADRESSE DES IMPORTEURE:

MH Handel GmbH

Wendenstraße 309

D-20537 Hamburg

Germany

IN CHINA HERGESTELLT

IT

In caso di dubbio, si prega di contattare il nostro centro assistenza clienti.

I nostri dettagli di contatto sono di seguito:



0039-0249471447



clienti@aosom.it

IMPORTATO DA:

AOSOM Italy srl

Centro Direzionale Milanofiori

Strada 1 Palazzo F1

20057 Assago (MI)

P.I.: 08567220960

FATTO IN CINA