

# PawHut

Q GHEJEEFI XEF' ÖŠ

D' &-\$&&J \$\$

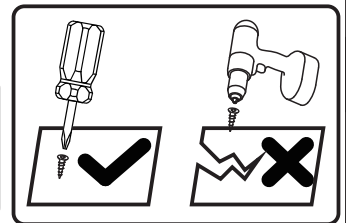
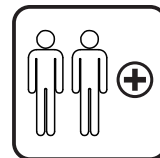
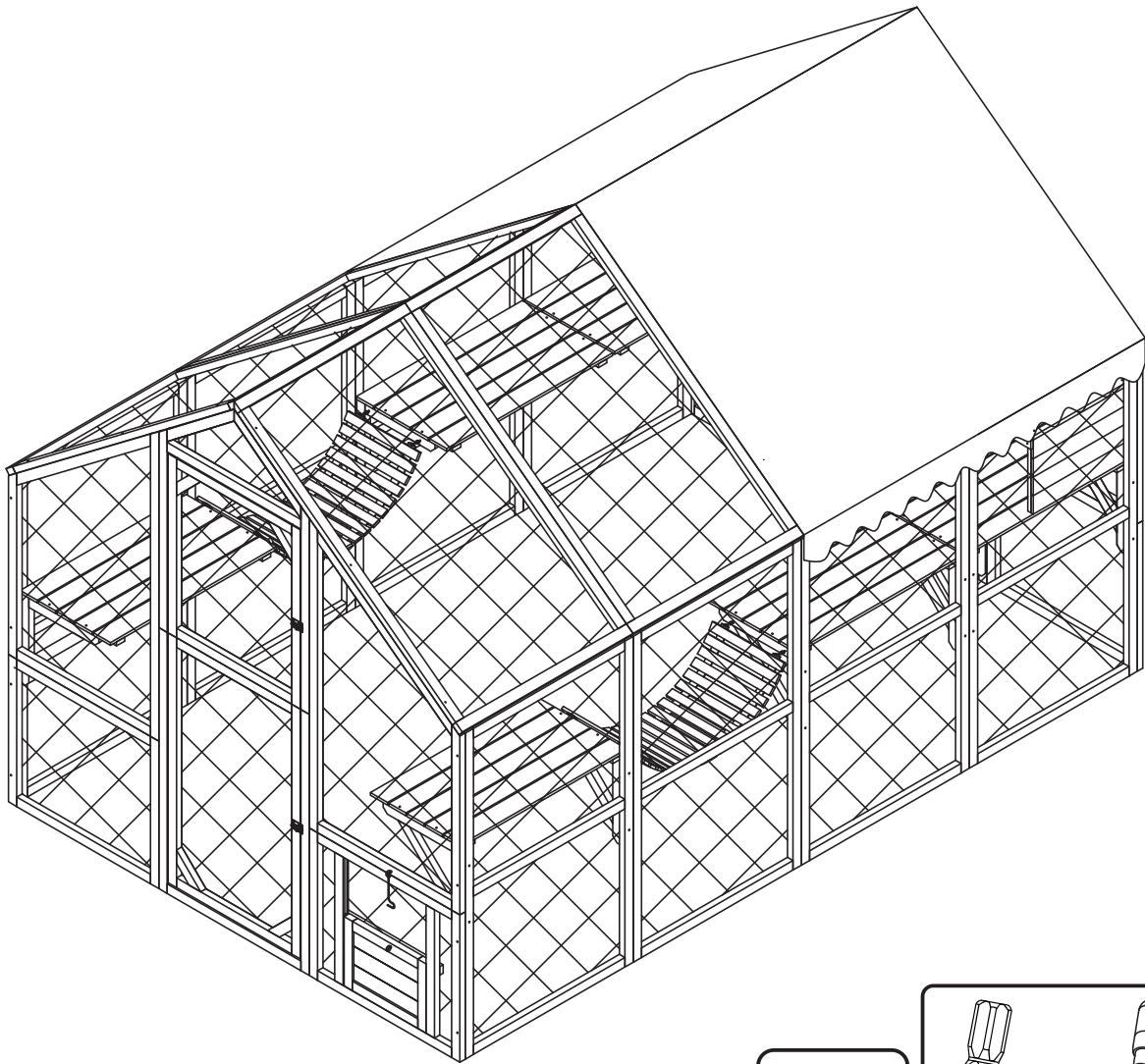

Tools Recommended

**EN\_IMPORTANT, RETAIN FOR FUTURE REFERENCE: READ CAREFULLY.**

**FR\_IMPORTANT: A LIRE ATTENTIVEMENT ET À CONSERVER POUR CONSULTATION ULTÉRIEURE.**

**ES\_IMPORTANTE, LEA Y GUARDE PARA FUTURAS REFERENCIAS.**

**PT\_IMPORTANTE, RETER PARA REFERÊNCIA FUTURA: LEIA ATENTAMENTE.**

**DE\_WICHTIG! SORGFÄLTIG LESEN UND FÜR SPÄTER NACHSCHLAGEN AUFBEWAHREN.**

**IT\_IMPORTANTE! CONSERVARE IL PRESENTE MANUALE PER FUTURO RIFERIMENTO E LEGGERLO ATTENTAMENTE.**

**BOX  
1-2**

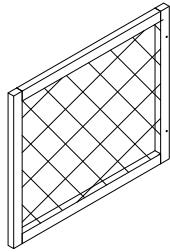

**5**

**2PCS**

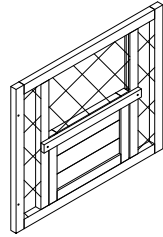

**6**

**2PCS**

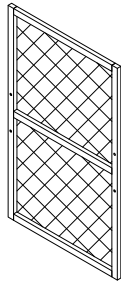

**7**

**2PCS**

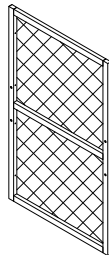
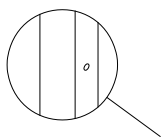

**8**

**4PCS**

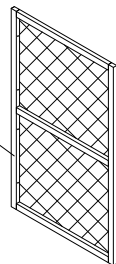
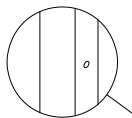

**11**

**2PCS**

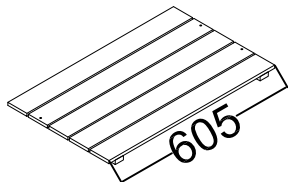

**12**

**2PCS**

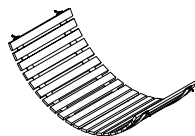

**14**

**2PCS**

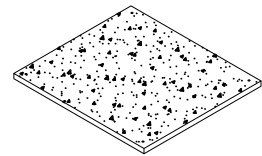

**15**

**2PCS**

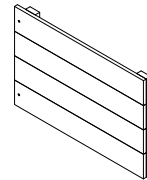

**17**

**2PCS**

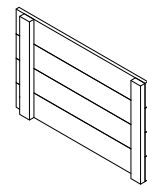

**18**

**2PCS**

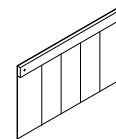

**19**

**2PCS**

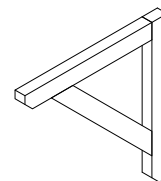

**25**

**14PCS**



**BOX  
2-2**

**1**

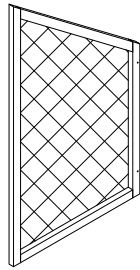

**2PCS**

**2**

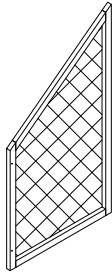

**2PCS**

**3**

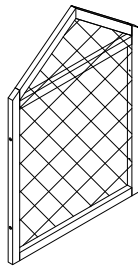

**1PC**

**4**

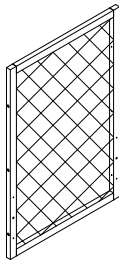

**1PC**

**9**

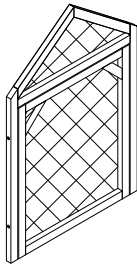

**1PC**

**10**

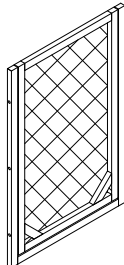

**1PC**

**13**

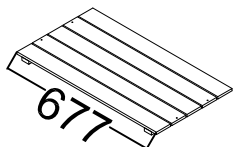

**6PCS**

**16**

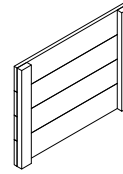

**2PCS**

**20**

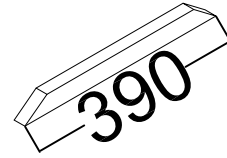

**6PCS**

**21**



**12PCS**

**22**

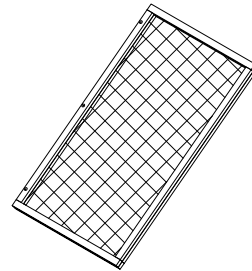

**1PC**

**23**

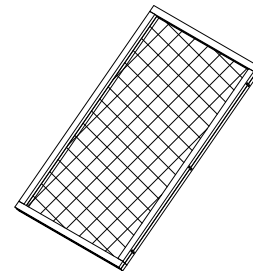

**2PCS**

**24**

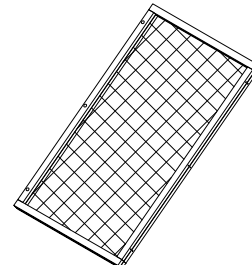

**1PC**

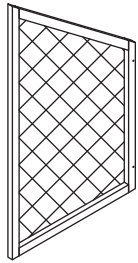

① x02

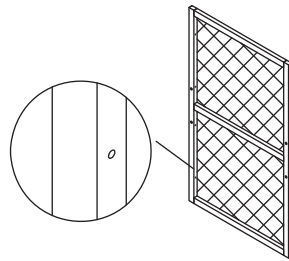

③ x04

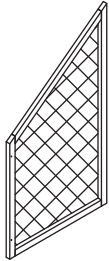

② x02

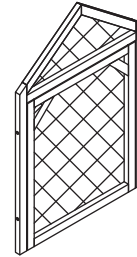

⑨ x01

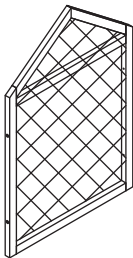

③ x01

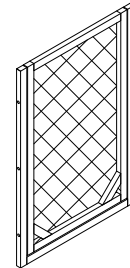

⑩ x01

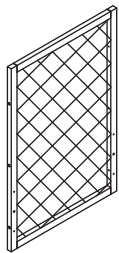

④ x0%

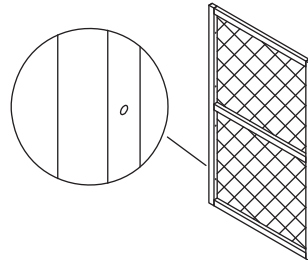

⑪ x02

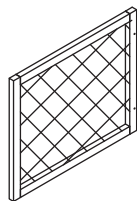

⑤ x02

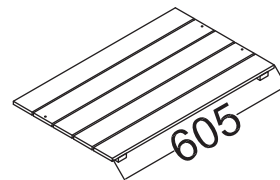

⑫ x01

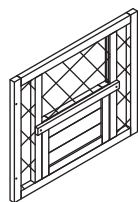

⑥ x02

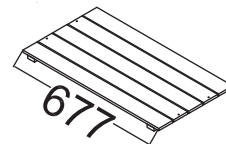

⑬ x06

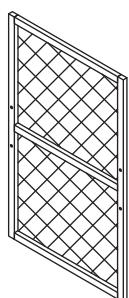

⑦ x02

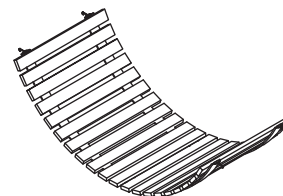

⑭ x02

15 x02

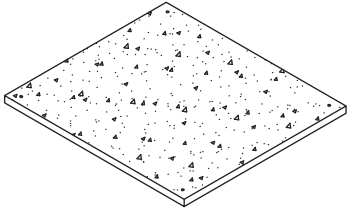

22 x01

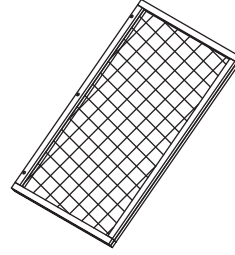

16 x02

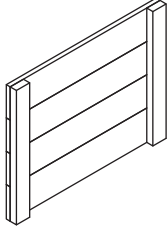

23 x02

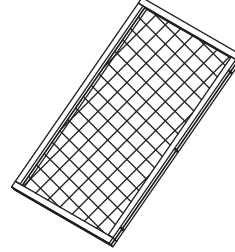

17 x02

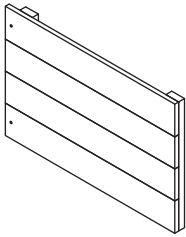

24 x01

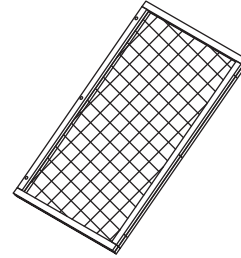

18 x02

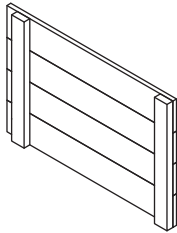

25 x14

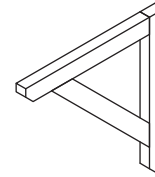

19 x02

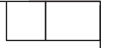
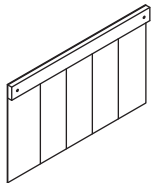



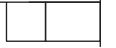
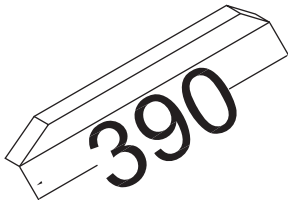

20 x06

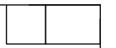

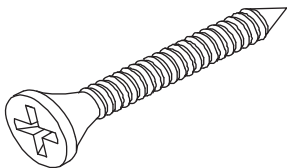
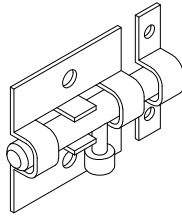
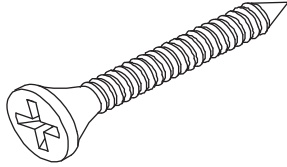
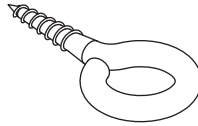
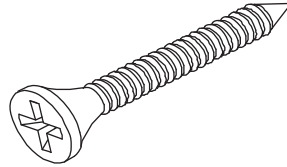
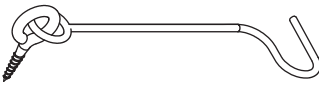
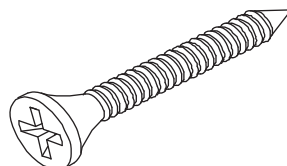
21 x12

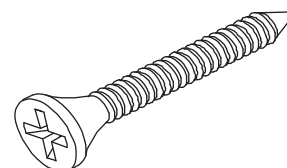

 <p><b>A x78+2(spare)</b></p> <p>M3.5*60</p>	 <p><b>F x02</b></p>
 <p><b>B x56+2(spare)</b></p> <p>M3.5*40</p>	 <p><b>G x10+1(spare)</b></p>
 <p><b>C x36+2(spare)</b></p> <p>M3.5*35</p>	 <p><b>H x02</b></p>
 <p><b>D x48+2(spare)</b></p> <p>M3*30</p>	 <p><b>I x01</b></p>
 <p><b>E x12+1(spare)</b></p> <p>M3*16</p>	 <p><b>J x02</b></p>
	 <p><b>K x14+1(spare)</b></p>

**EN\_** Do not confuse similar screws.  
**FR\_** Ne pas confondre des vis similaires.  
**ES\_** No confunda tornillos similares.  
**PT\_** Não confundir parafusos semelhantes.  
**DE\_** Verwechseln Sie ähnliche Schrauben nicht.  
**IT\_** Non confondere le viti simili.

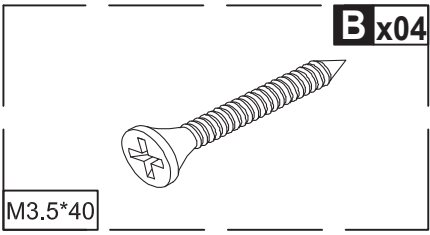
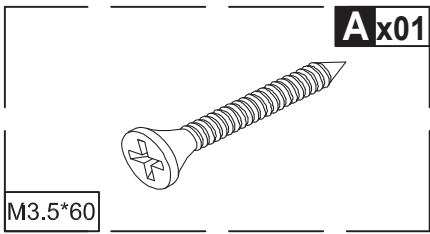

7

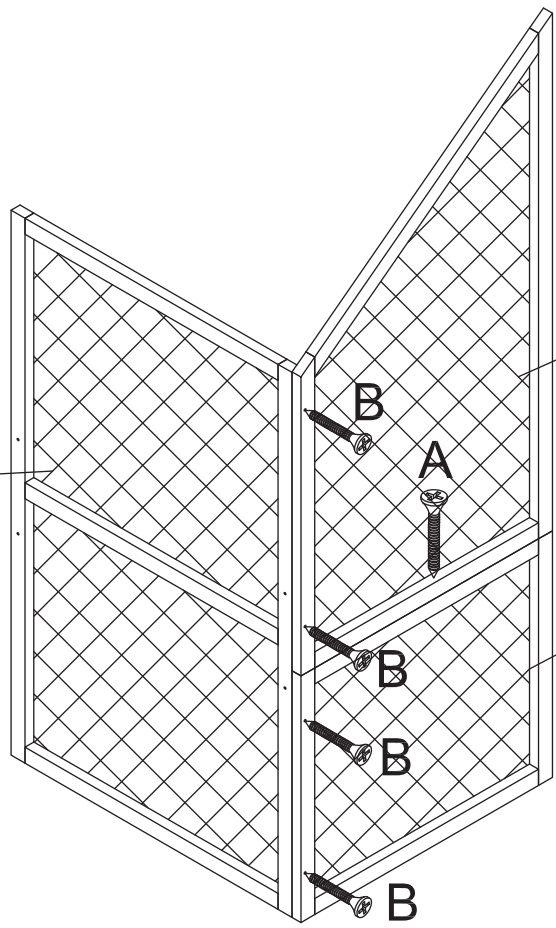

2

5

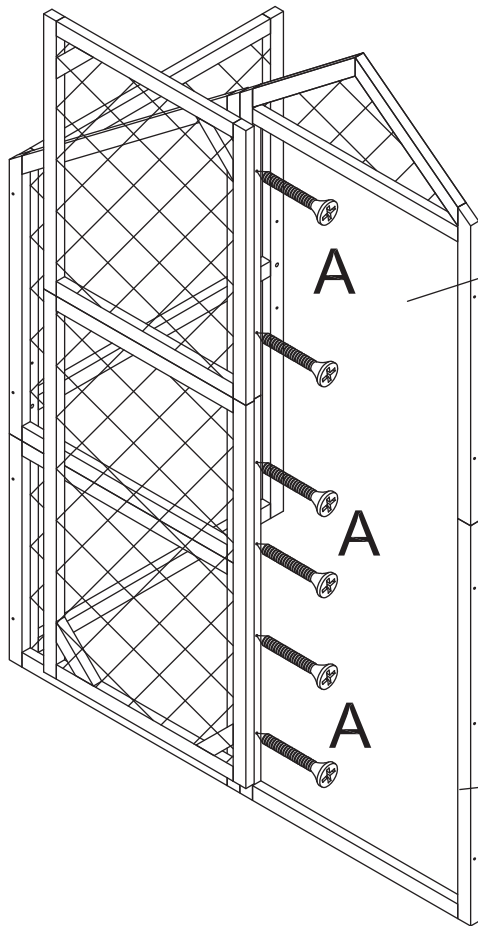
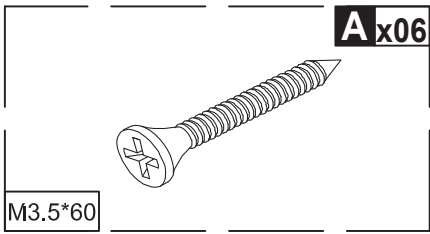

9

10



Ax01

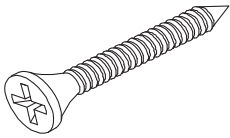

M3.5\*60

Bx04

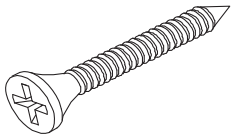

M3.5\*40

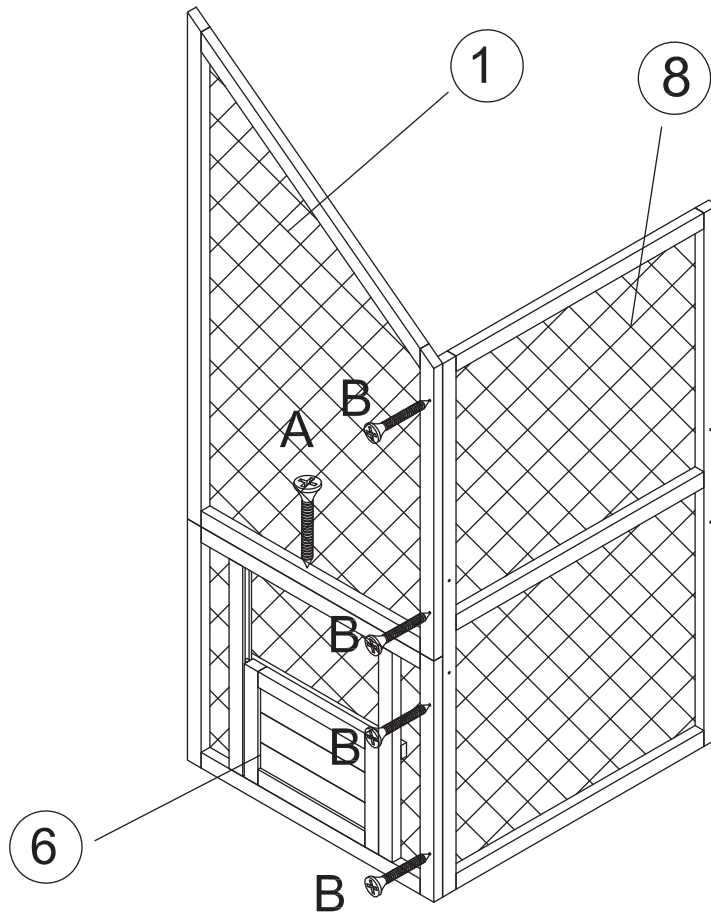

Ax06

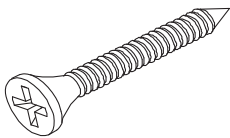

M3.5\*60

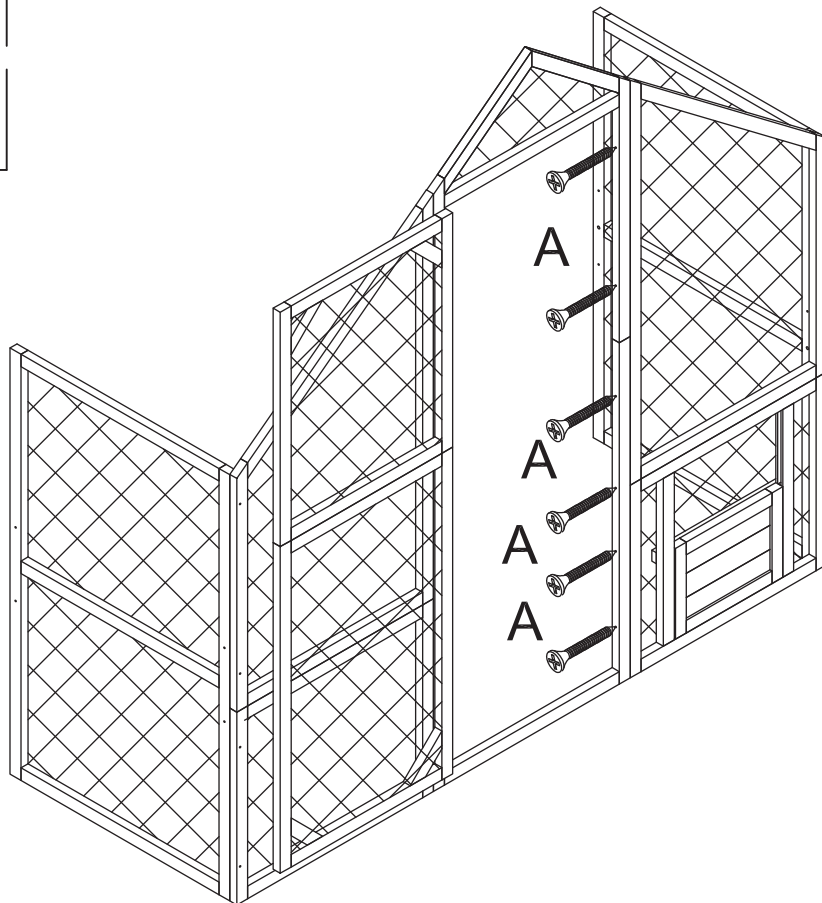

**A**x12

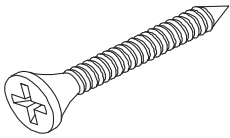

M3.5\*60

**E**x08

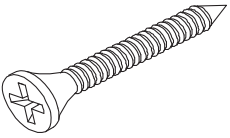

M3\*16

**F**x02

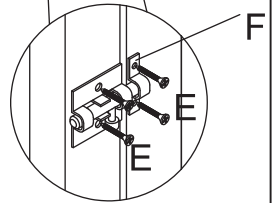
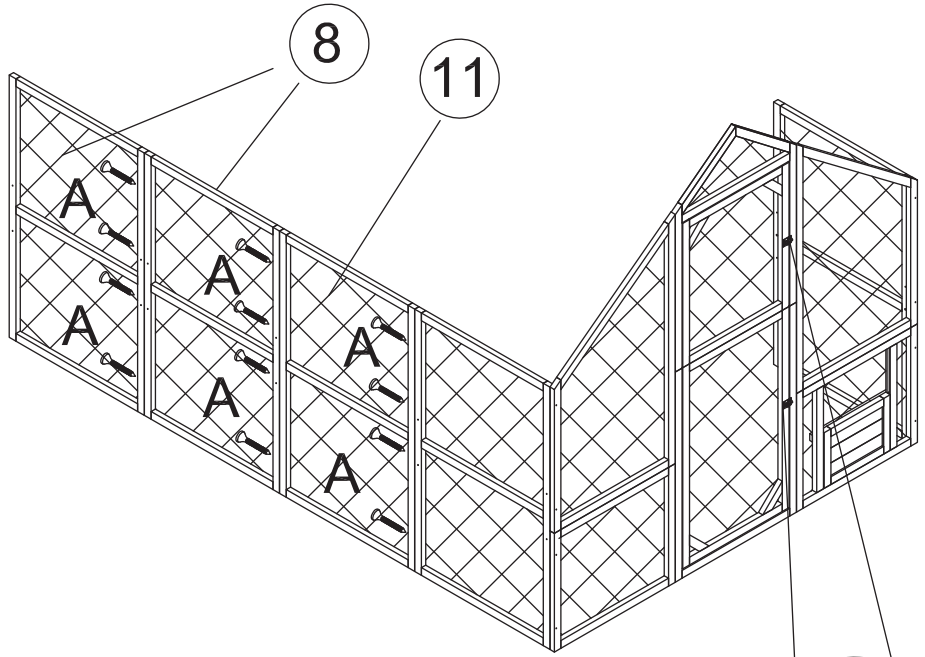
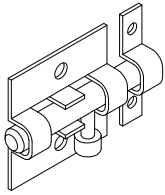

**K**x14

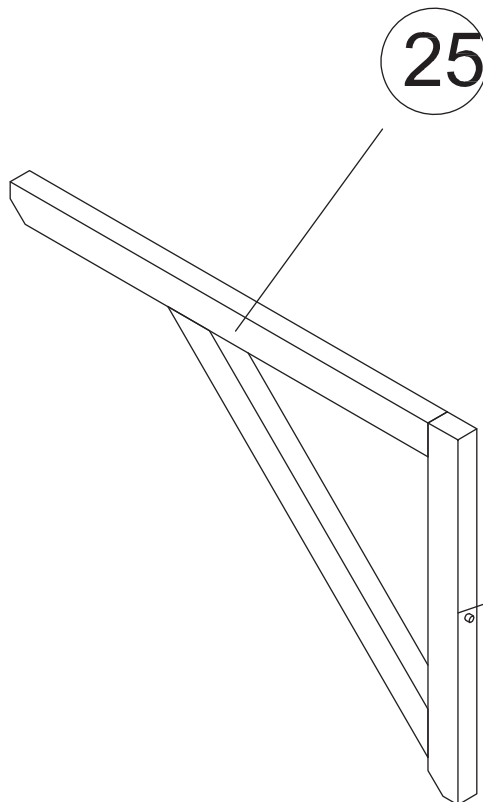
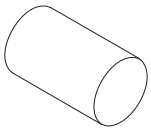

**x14**

**Bx12**

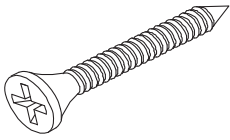

M3.5\*40

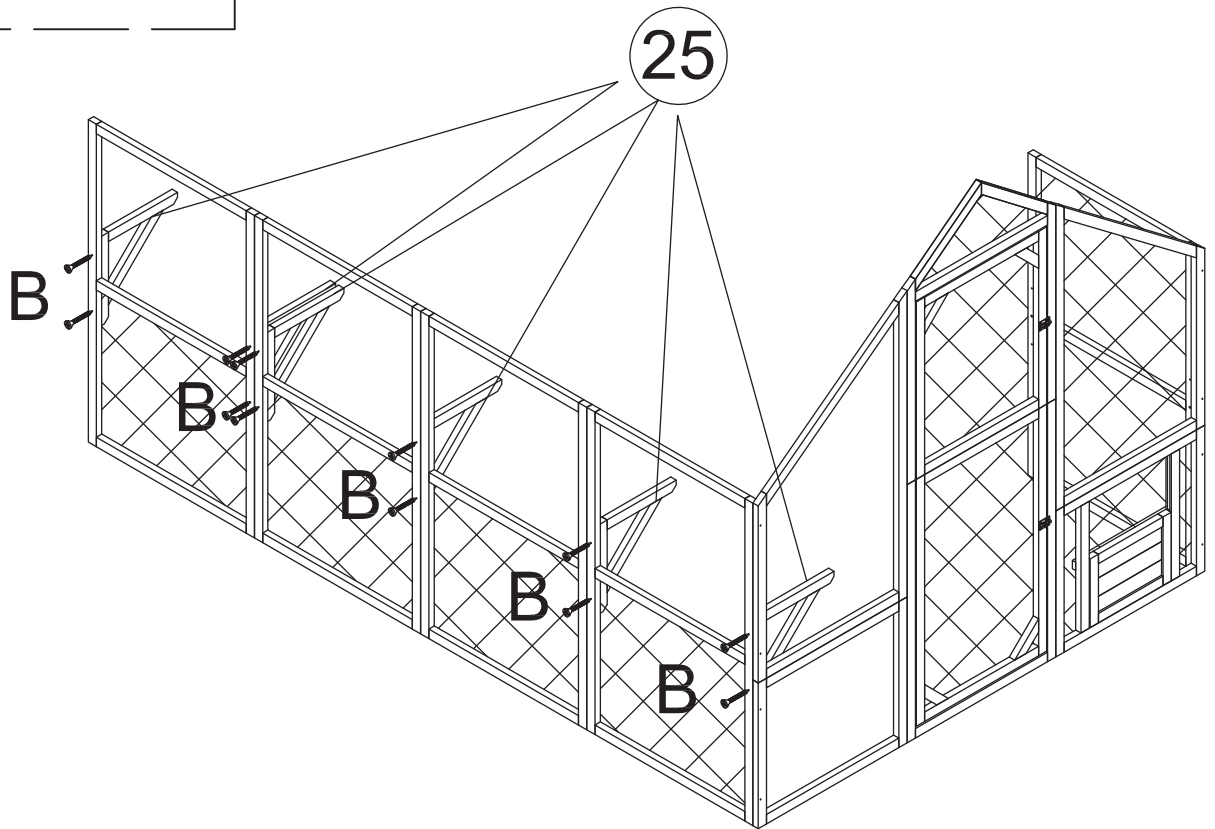

**Gx04**

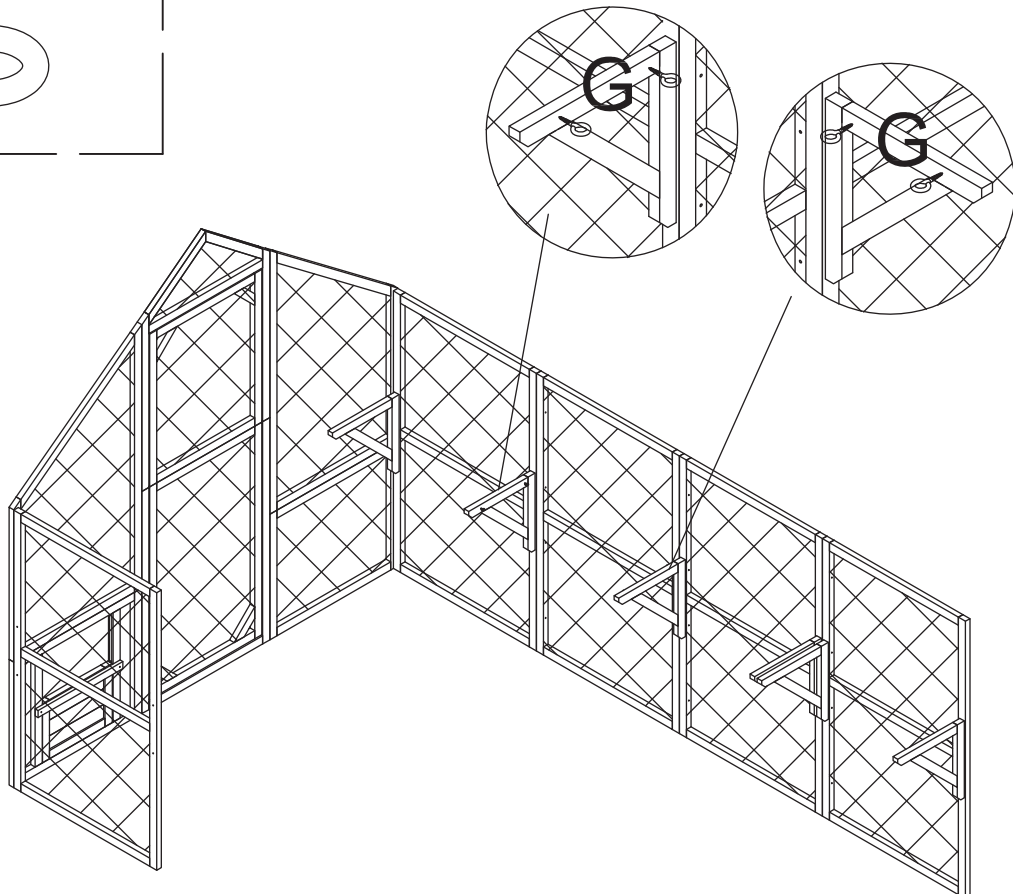
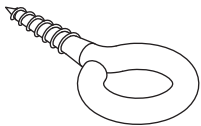

**Dx12**

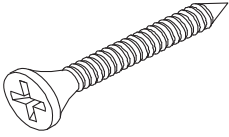

M3\*30

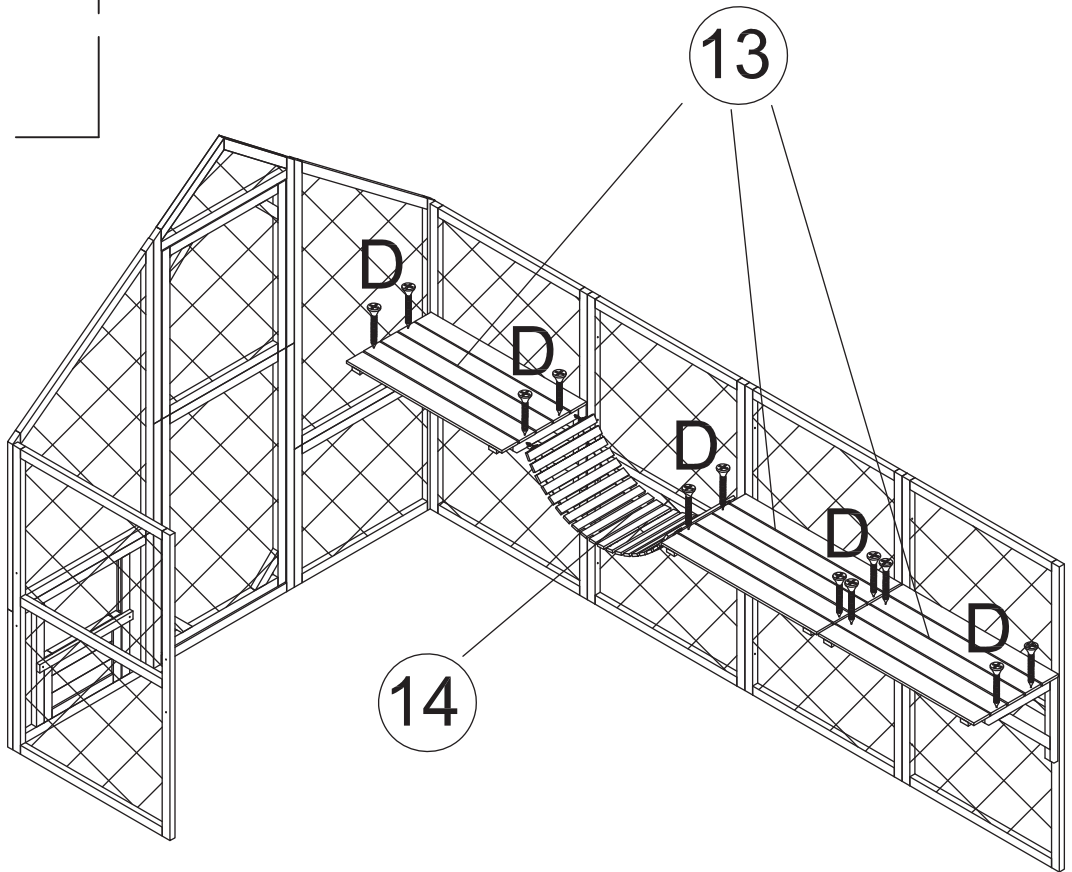

**Ax12**

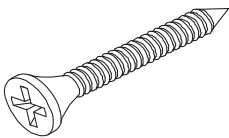

M3.5\*60

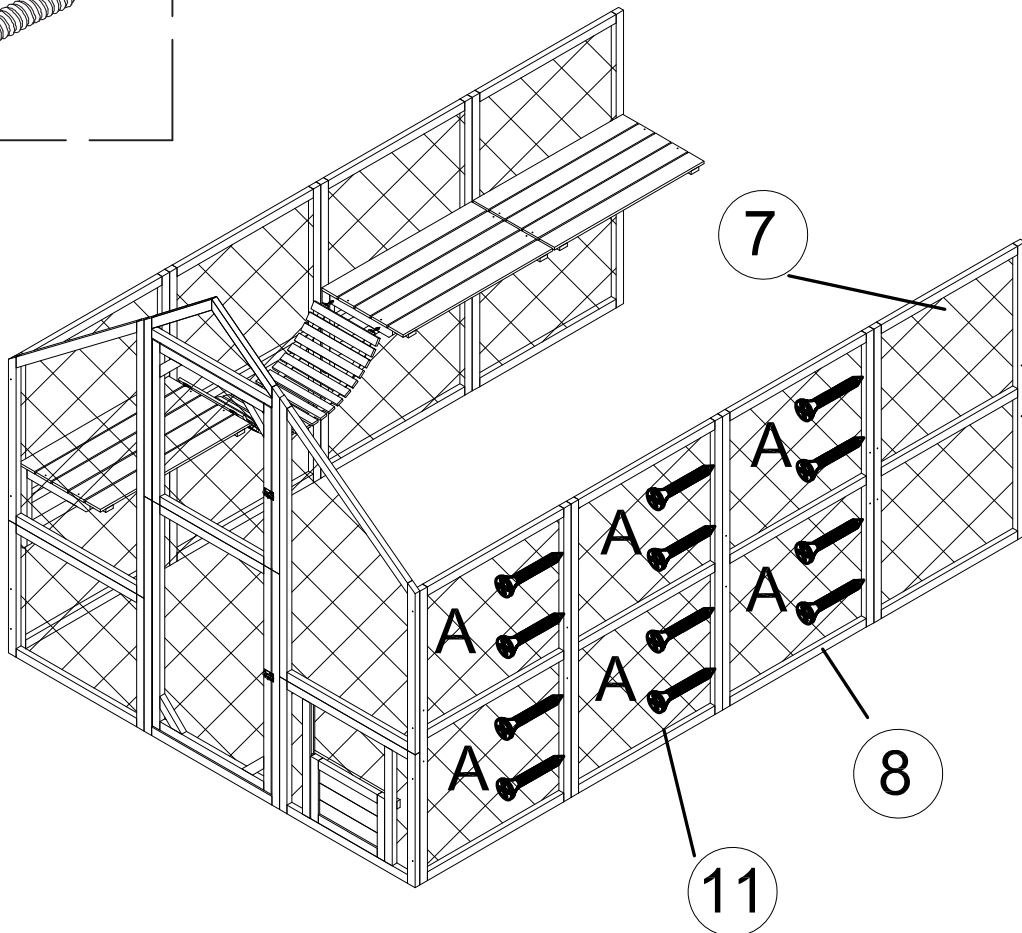

**Bx12**

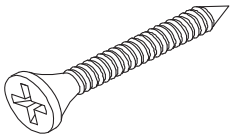

M3.5\*40

**Gx01**

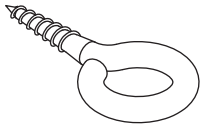

**Hx01**

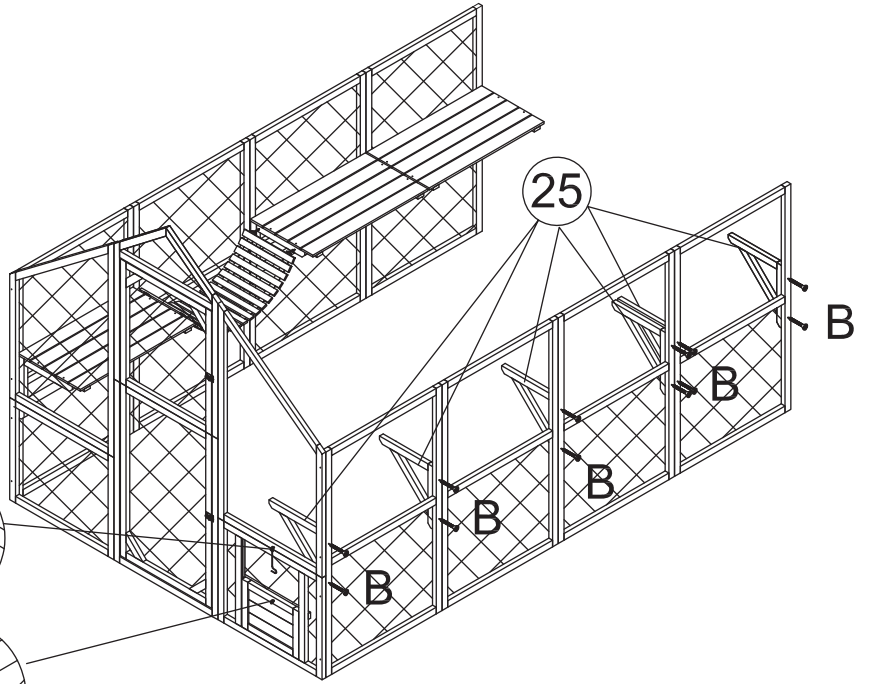
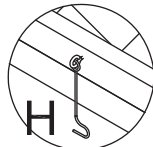
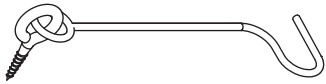

**Gx04**

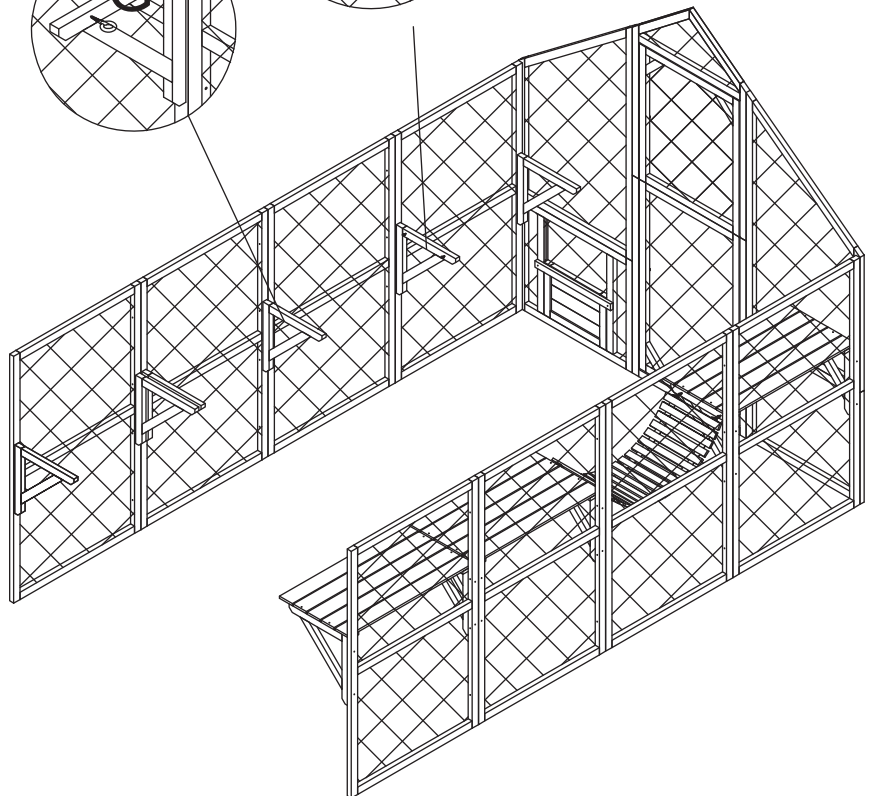
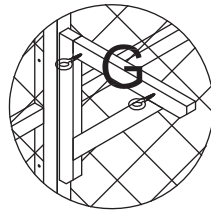
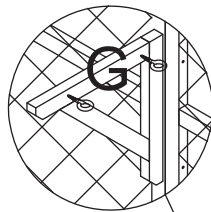
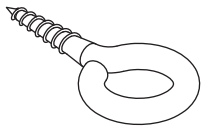

**D**x12

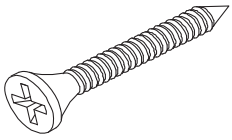

M3\*30

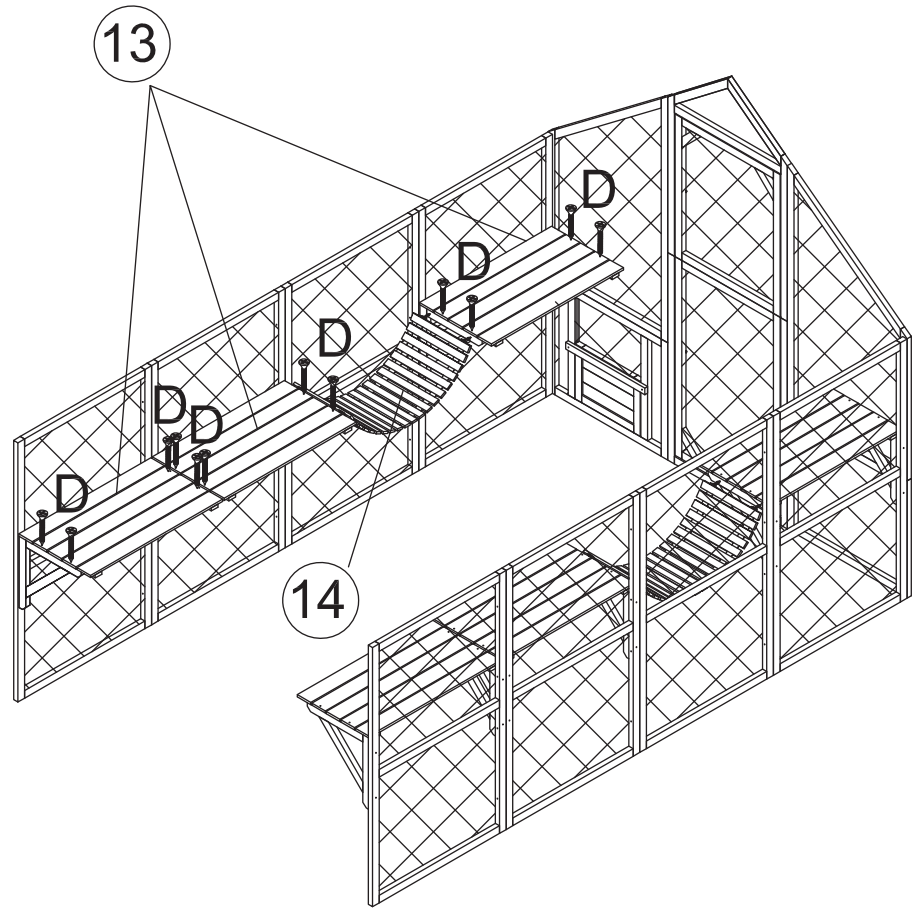

**D**x20

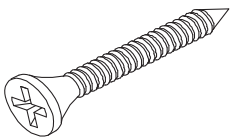

M3\*30

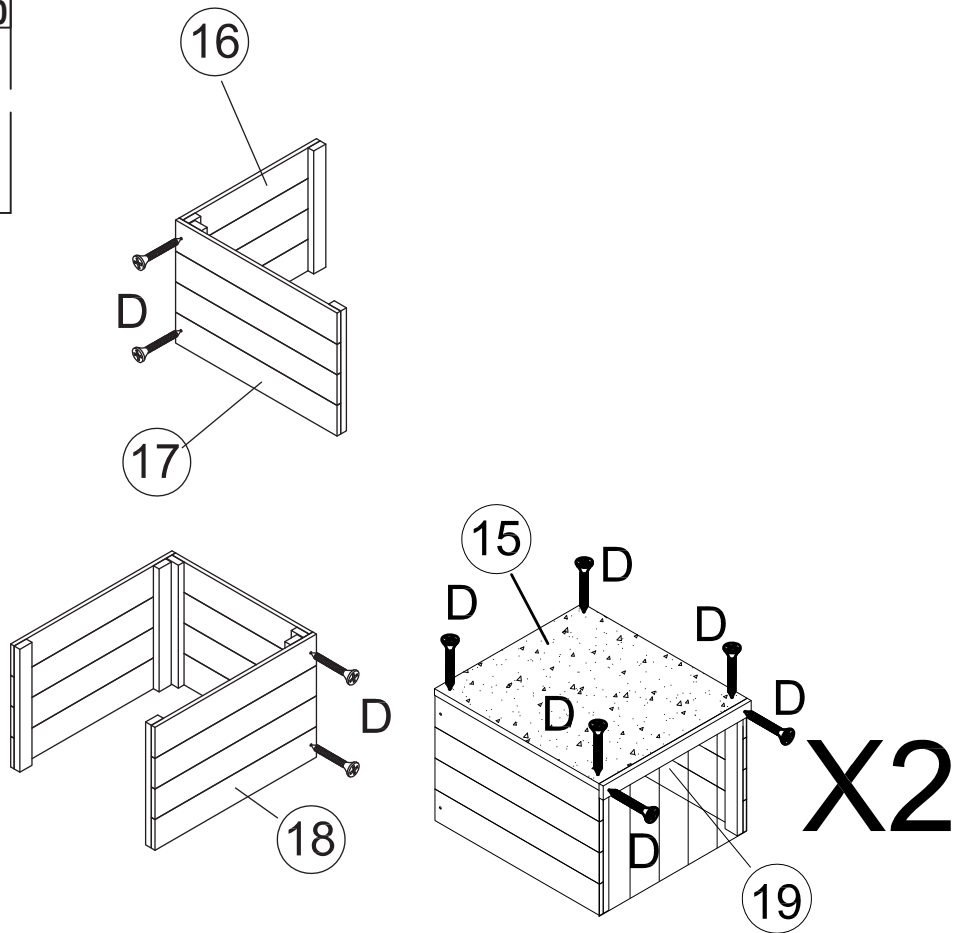

**E**x04

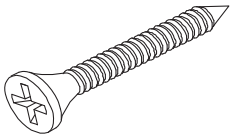

M3\*16

**J**x02

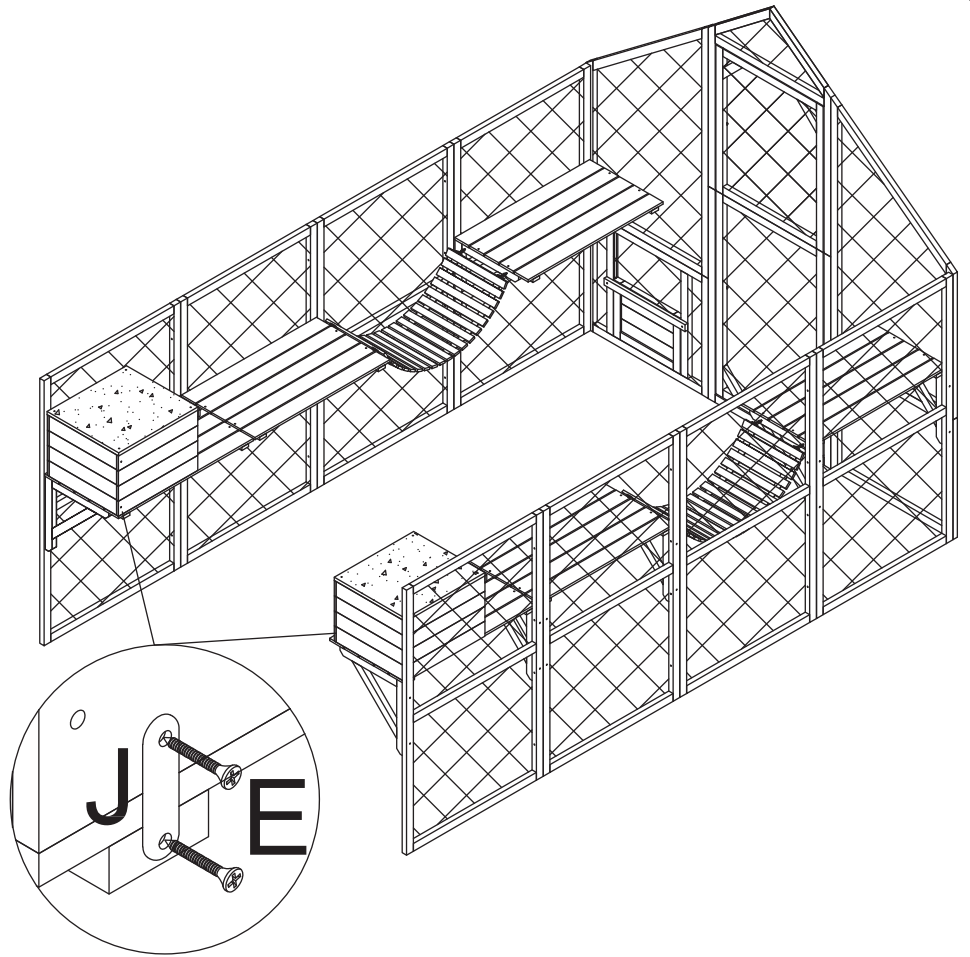

**A**x01

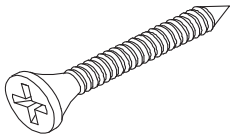

M3.5\*60

**B**x04

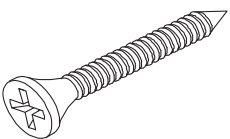

M3.5\*40

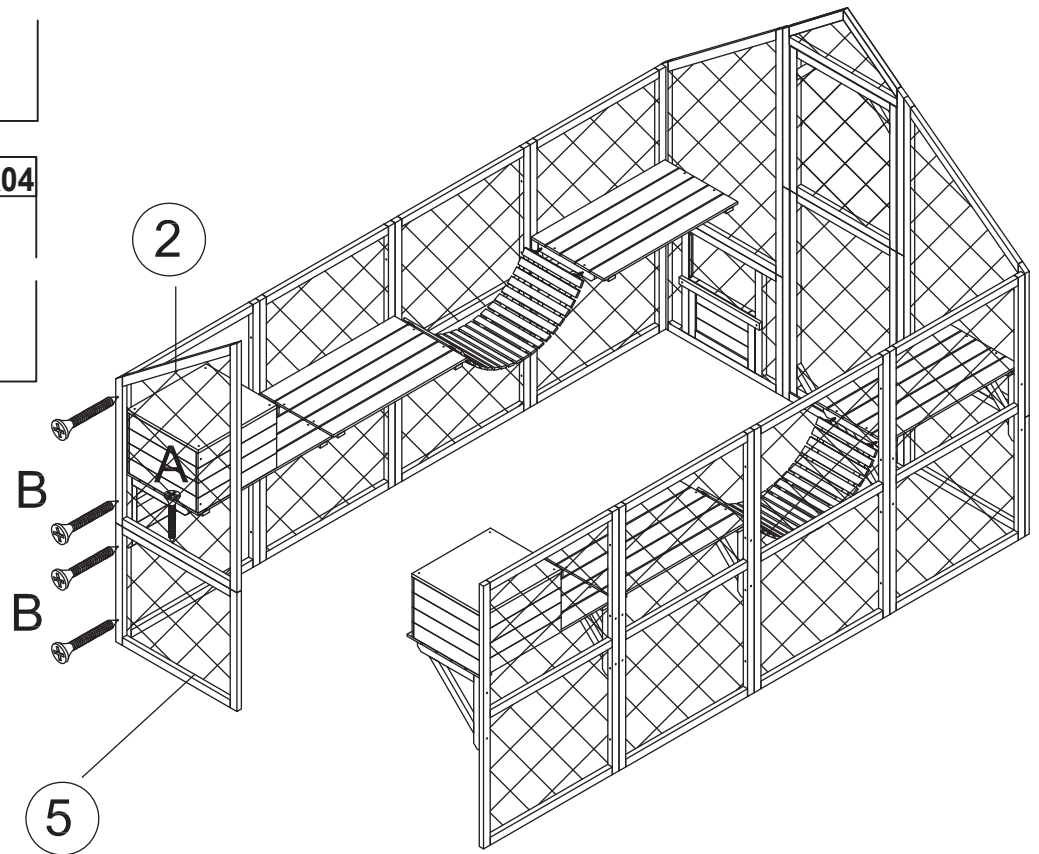

**B**x04

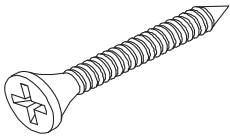

M3.5\*40

**D**x04

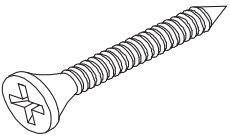

M3\*30

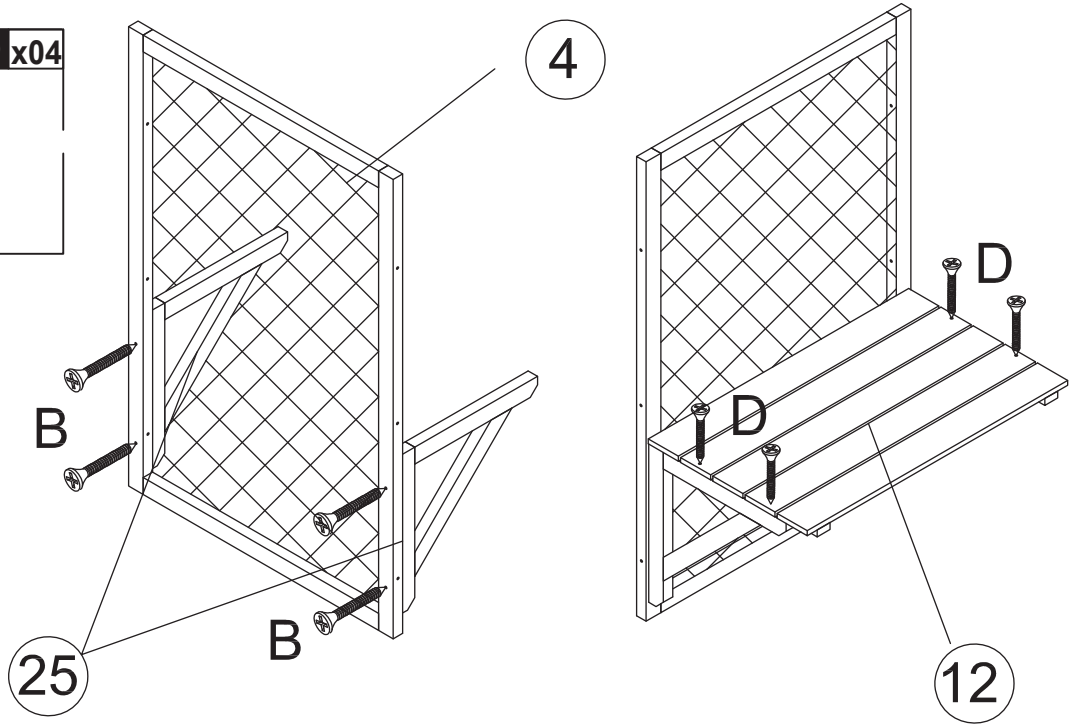

**A**x06

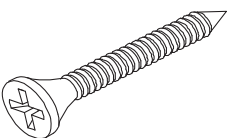

M3.5\*60

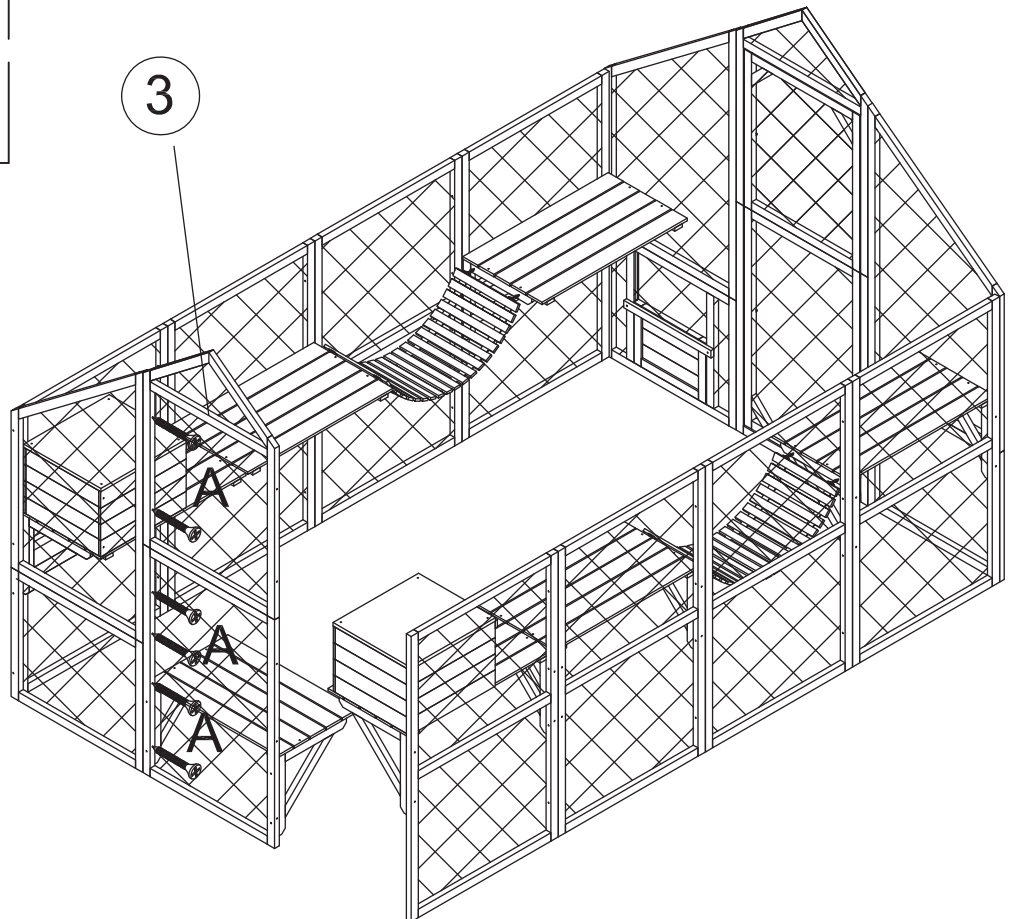



**A**x07

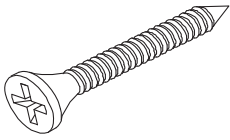

M3.5\*60

**B**x04

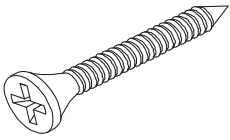

M3.5\*40

**G**x01

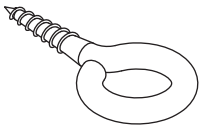

**H**x01

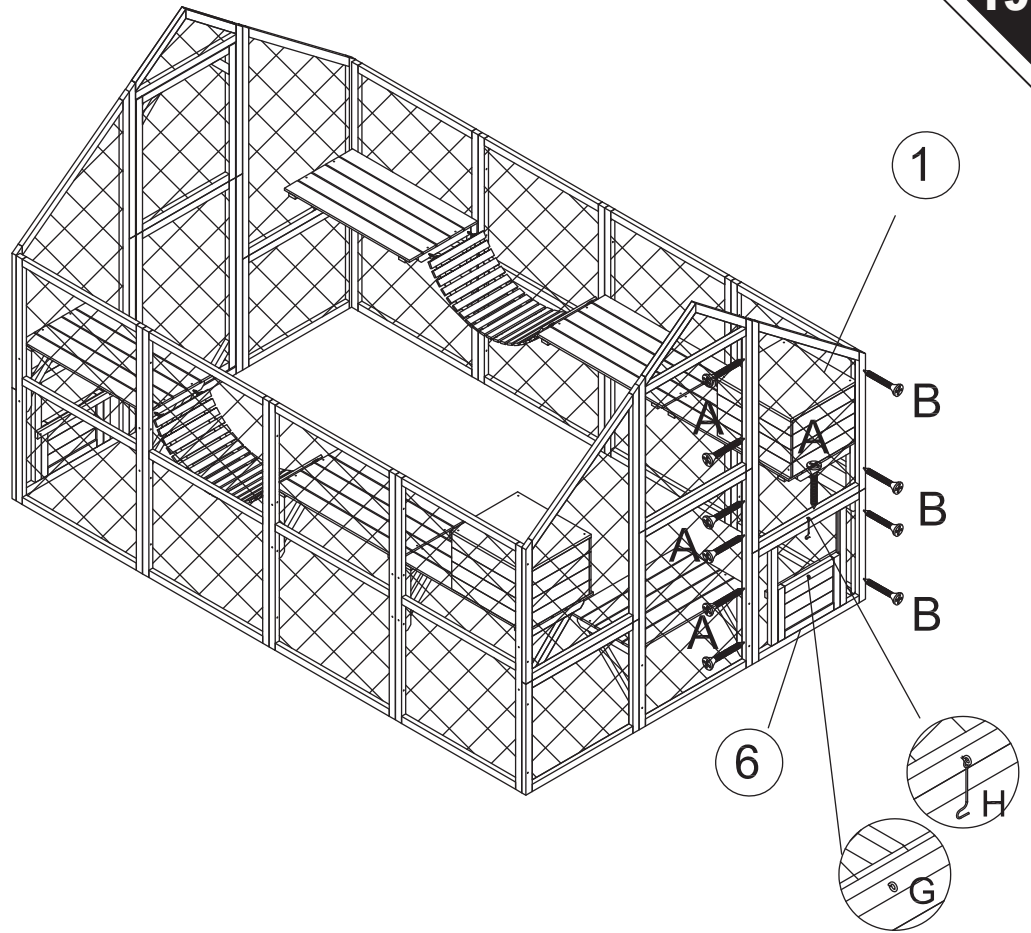

**A**x18

M3.5\*60

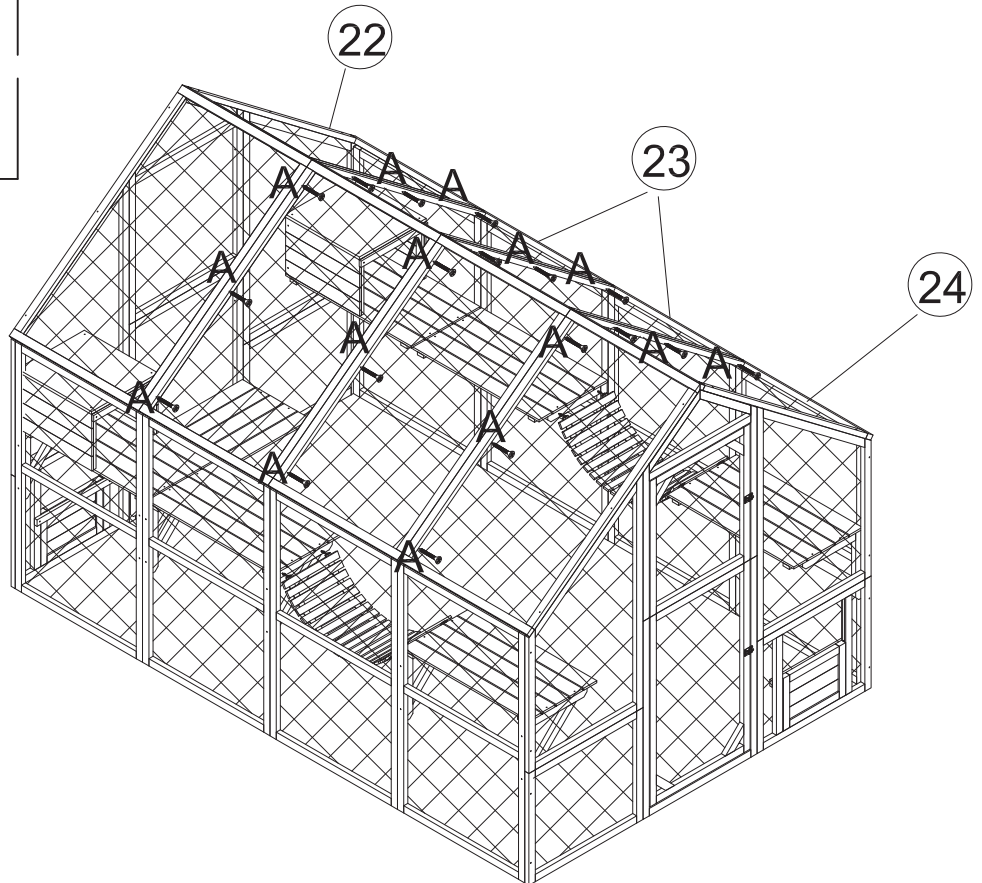

**A**x04

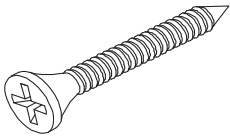

M3.5\*60

**B**x12

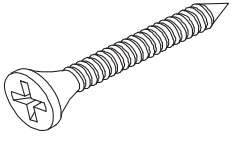

M3.5\*40

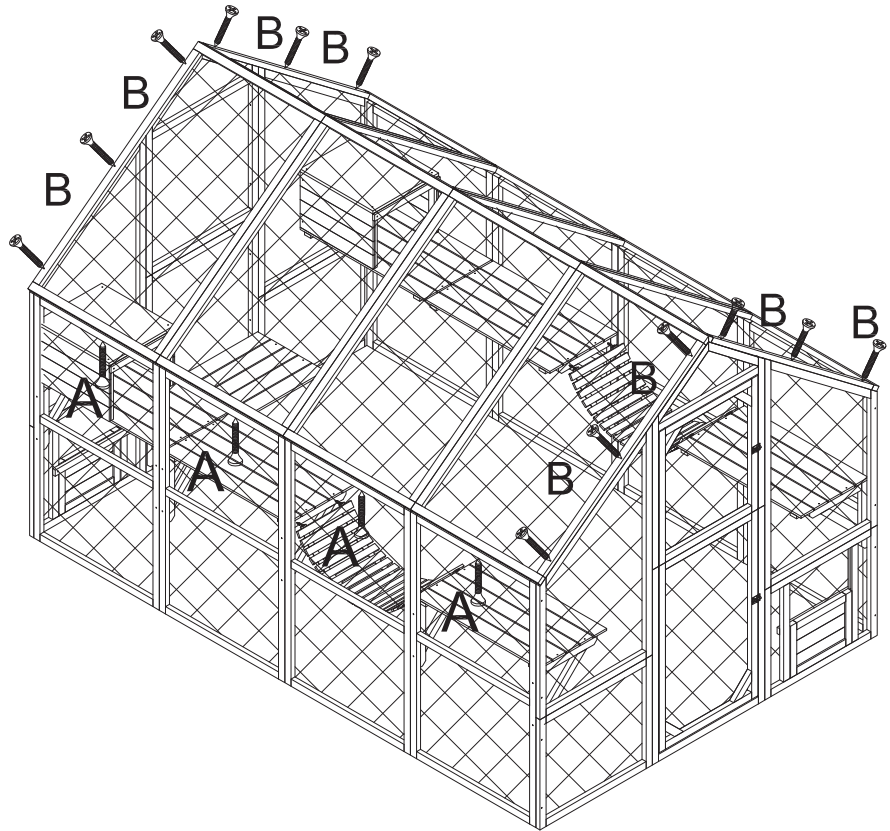

**A**x04

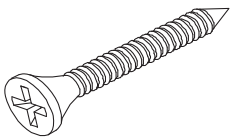

M3.5\*60

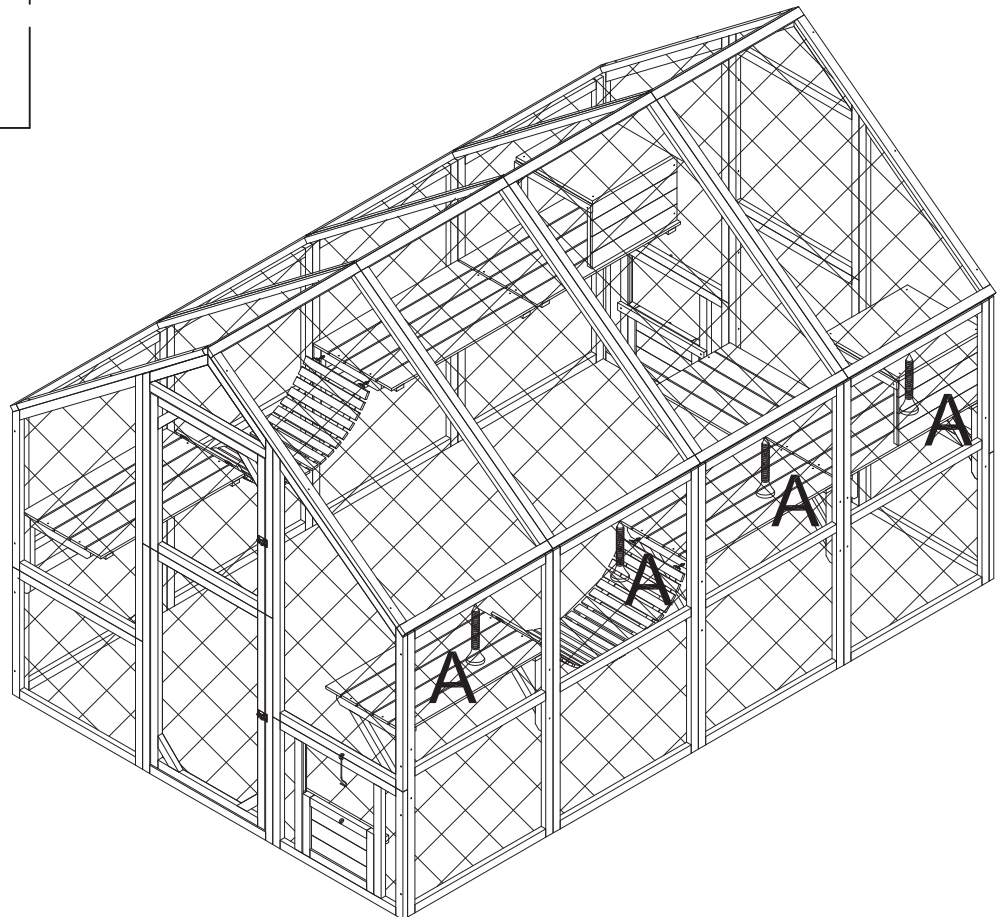

**C**x36

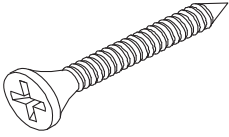

M3.5\*35

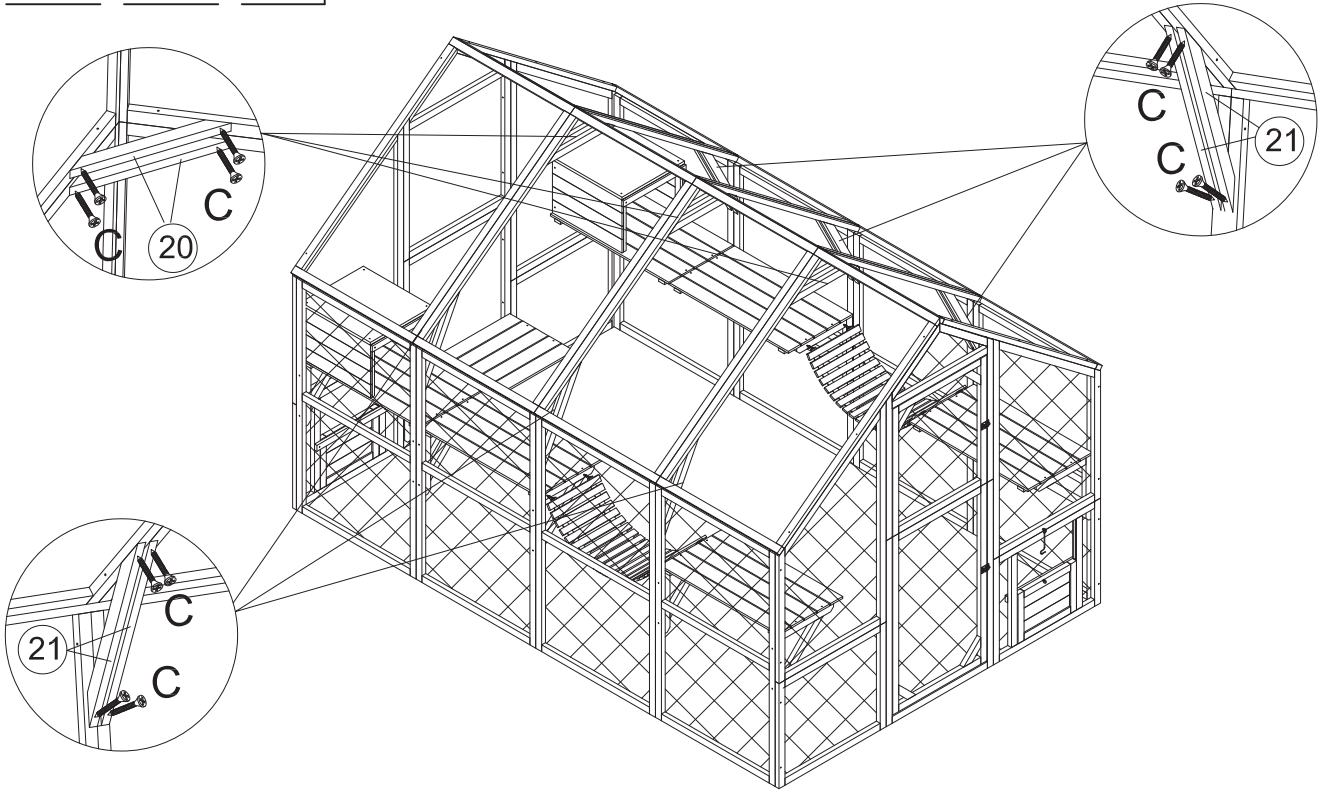

**I**x01

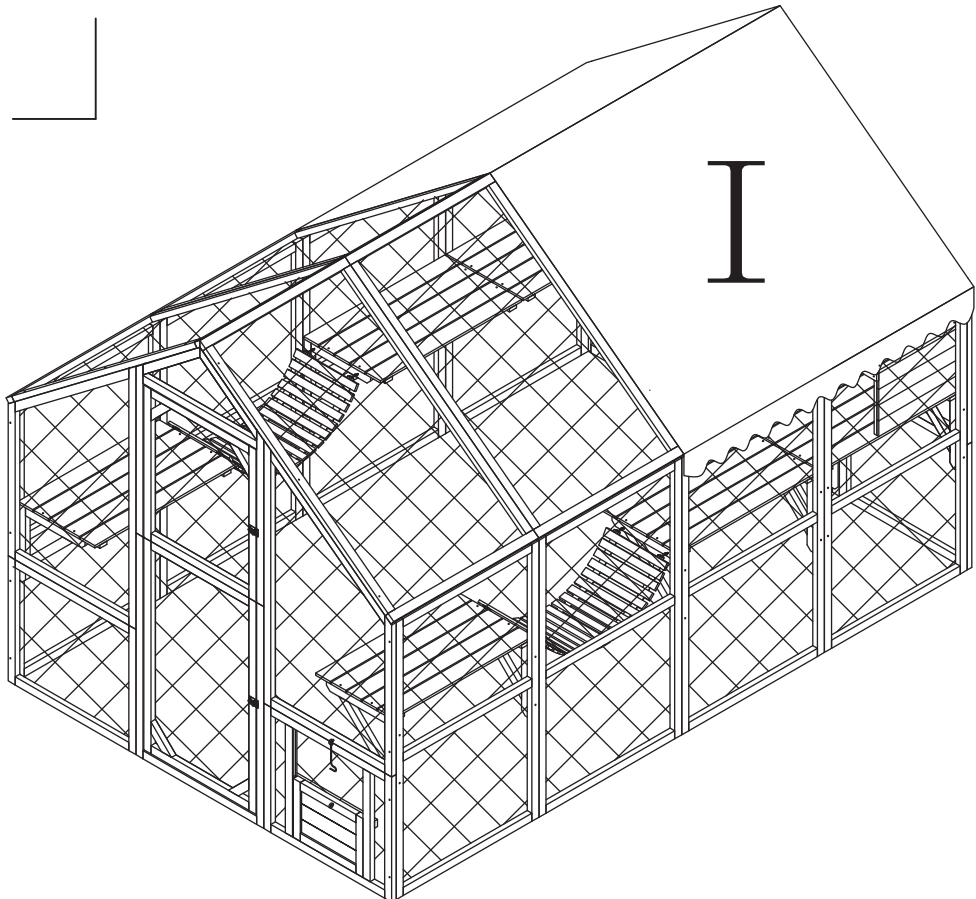

Done

**US**

If you have any questions, please contact our customer care center.

Our contact details are below:

 001-877-644-9366

 customerservice@aosom.com

Imported by Aosom LLC  
27150 SW Kinsman Rd Wilsonville, OR 97070 USA  
MADE IN CHINA

**CA**

If you have any questions, please contact our customer care center.

Our contact details are below:

Si vous avez la moindre question, veuillez contacter notre centre d'assistance à la clientèle. Nos coordonnées sont les suivantes:

 416-792-6088

 customerservice@aosom.ca

Imported by Aosom Canada Inc.  
7270 Woodbine Avenue, Unit 307, Markham,  
Ontario Canada L3R 4B9  
MADE IN CHINA

Importé par Aosom Canada Inc.  
7270 Woodbine Avenue, unité 307,  
Markham, Ontario Canada L3R 4B9  
Fabriqué en Chine

**UK**

If you have any questions, please contact our customer care center.

Our contact details are below:

 0044-800-240-4004

 enquiries@mhstar.co.uk

IMPORTER ADDRESS:  
MH STAR UK LTD  
Unit 27, Perivale Park,  
Horsenden lane South  
Perivale, UB6 7RH  
MADE IN CHINA

**FR**

Si vous avez la moindre question, veuillez contacter notre centre d'assistance à la clientèle.

Nos coordonnées sont les suivantes:

 0033-1-84166106

 aosom@mhfrance.fr

Importé par:  
MH France  
2, rue Maurice Hartmann  
92130 Issy-les-Moulineaux  
France  
Fabriqué en Chine

**ES**

Si tiene alguna pregunta, comuníquese con nuestro Centro de Atención al Cliente. Nuestros datos de contacto son los siguientes:

 0034-931294512

 atencioncliente@aosom.es

IMPORTADOR:  
SPANISH AOSOM, S.L.  
C/ ROC GROS, N° 15. 08550, ELS HOSTALET DE  
BALENYÀ, SPAIN.  
B66295775  
WWW.AOSOM.ES  
ATENCIONCLIENTE@AOSOM.ES  
TEL: 931294512  
HECHO EN CHINA

**PT**

Se tiver alguma dúvida, por favor contacte o nosso Centro de Atendimento ao Cliente. Os nossos dados de contacto são os seguintes:

 0034-931294512

 info@aosom.pt.

IMPORTADOR:  
SPANISH AOSOM, S.L.  
C.ROC GROS N.15, 08550. ELS HOSTALET DE BALENYÀ  
TEL: 931294512 (SEG-SEX DAS 7:30H ÀS 16:30H)  
INFO@AOSOM.PT  
WWW.AOSOM.PT

**DE**

Wenn Sie Fragen haben, wenden Sie sich bitte an unser Kundendienstzentrum. Unsere Kontaktdaten stehen unten:

 0049-0(40)-88307530

 service@aosom.de

ADRESSE DES IMPORTEUR:  
MH Handel GmbH  
Wendenstraße 309  
D-20537 Hamburg  
Germany  
IN CHINA HERGESTELLT

**IT**

In caso di dubbio, si prega di contattare il nostro centro assistenza clienti. I nostri dettagli di contatto sono di seguito:

 0039-0249471447

 clienti@aosom.it

IMPORTATO DA:  
AOSOM Italy srl  
Centro Direzionale Milanofiori  
Strada 1 Palazzo F1  
20057 Assago (MI)  
P.I.: 08567220960  
FATTO IN CINA

## Jouets, bricolage et jardinage

 **FR**  
**DONNEZ**  
OU  
**RECYCLEZ**

 OU  OU   
ASSOCIATION LIVRAISON DÉCHÈTERIE

Adresses sur [quefairedemesdechets.fr](https://quefairedemesdechets.fr)

## Généralistes

 **FR**  
**Pensez à**  
**donner ou recycler.**

 OU  OU   
Association Magasin Déchèterie

<https://quefairedemesdechets.fr>