

PawHut

IN230900314V02_GL

D32-022V00_D32-022V01

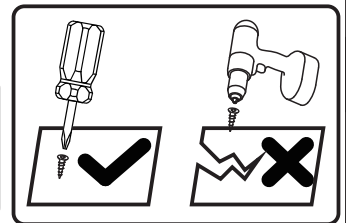
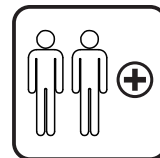
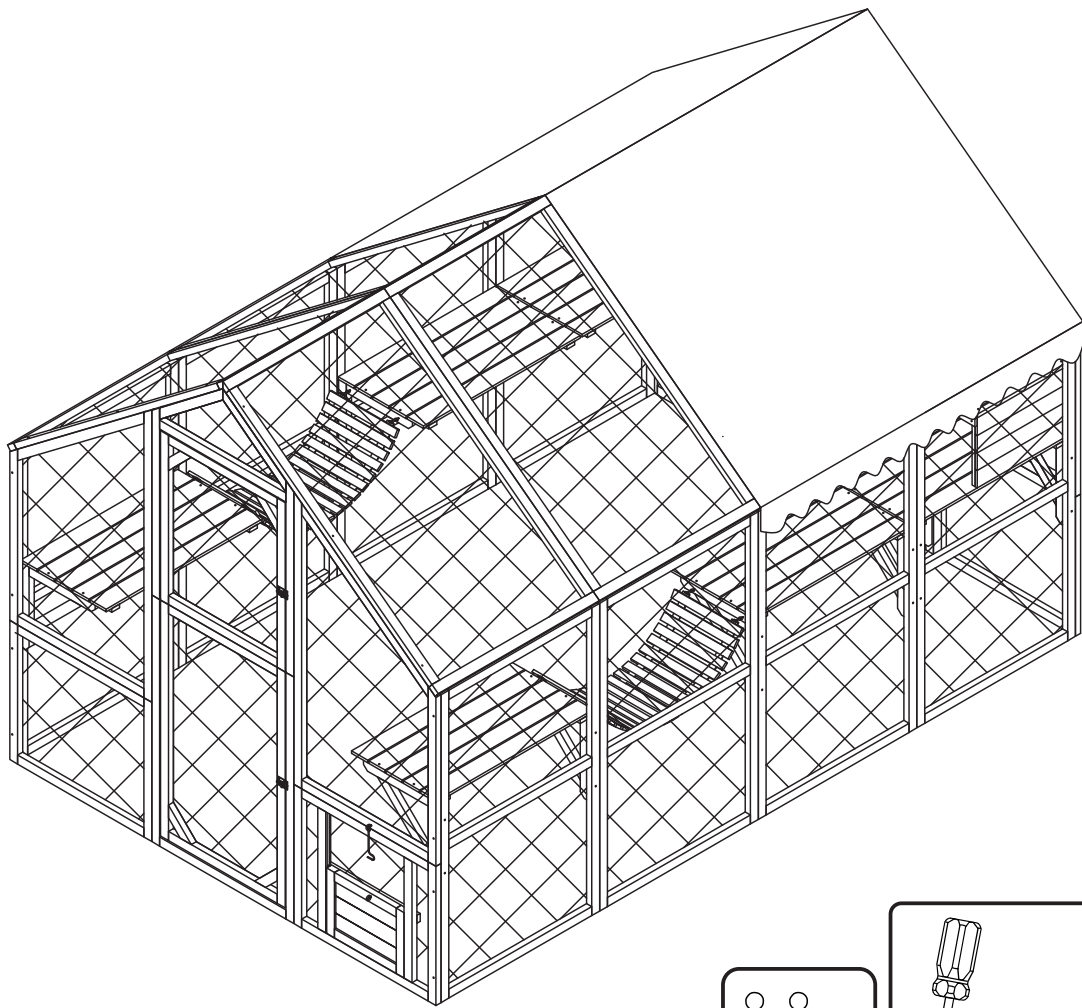

Tools Recommended

EN_IMPORTANT, RETAIN FOR FUTURE REFERENCE: READ CAREFULLY.

FR_IMPORTANT: A LIRE ATTENTIVEMENT ET À CONSERVER POUR CONSULTATION ULTÉRIEURE.

ES_IMPORTANTE, LEA Y GUARDE PARA FUTURAS REFERENCIAS.

PT_IMPORTANTE, RETER PARA REFERÊNCIA FUTURA: LEIA ATENTAMENTE.

DE_WICHTIG! SORGFÄLTIG LESEN UND FÜR SPÄTER NACHSCHLAGEN AUFBEWAHREN.

IT_IMPORTANTE! CONSERVARE IL PRESENTE MANUALE PER FUTURO RIFERIMENTO E LEGGERLO ATTENTAMENTE.

**BOX
1-2**

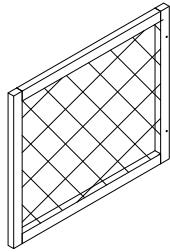

5

2PCS

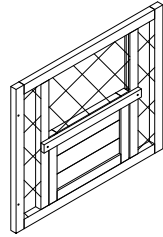

6

2PCS

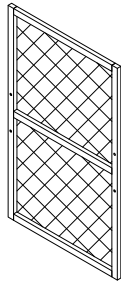

7

2PCS

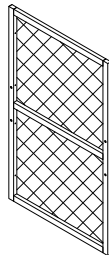
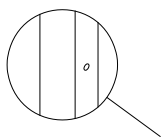

8

4PCS

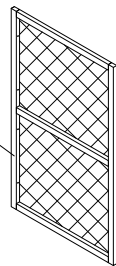
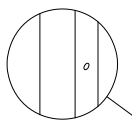

11

2PCS

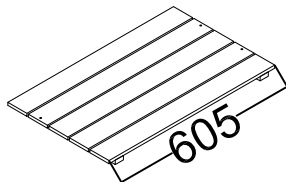

12

1PC

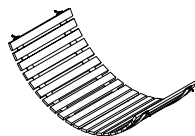

14

2PCS

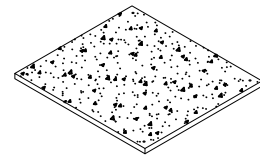

15

2PCS

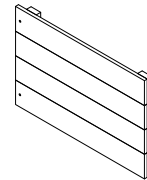

17

2PCS

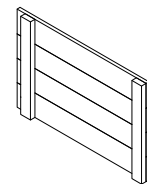

18

2PCS

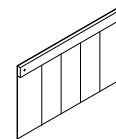

19

2PCS

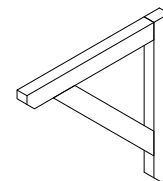

25

14PCS

**BOX
1-2**

A



3.5*60

78PCS
+2

B

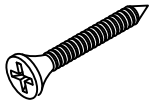

3.5*40

56PCS
+2

C

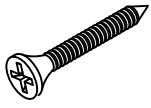

3.5*35

36PCS
+2

D

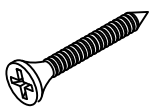

3*30

48PCS
+2

E

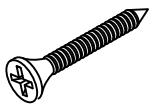

3*16

16PCS
+1

F

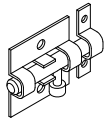

2PCS

G

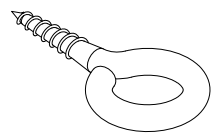

10PCS
+1

H

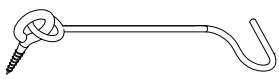

2PCS

I

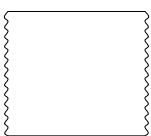

1PC

J



4PCS

K

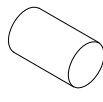

14PCS
+1

**BOX
2-2**

1

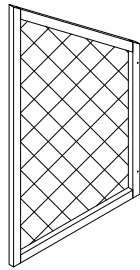

2PCS

2

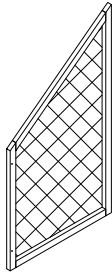

2PCS

3

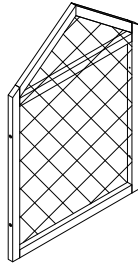

1PC

4

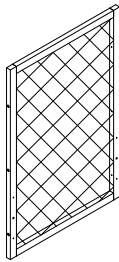

1PC

9

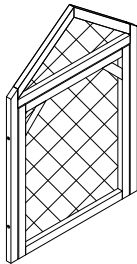

1PC

10

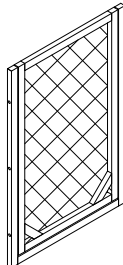

1PC

13

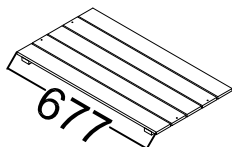

6PCS

16

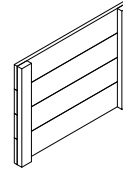

2PCS

20

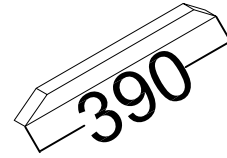

6PCS

21



12PCS

22

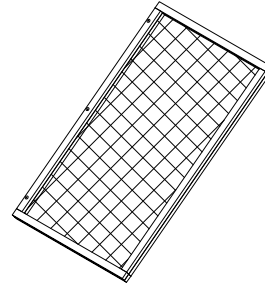

1PC

23

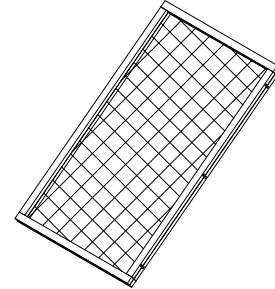

2PCS

24

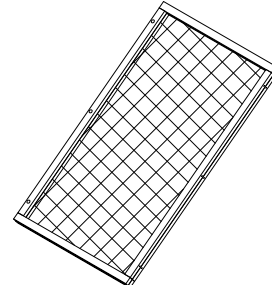

1PC

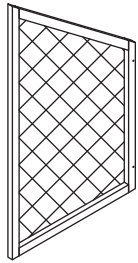

① x02

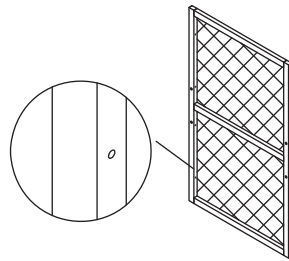

③ x04

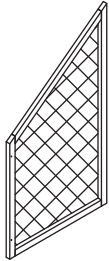

② x02

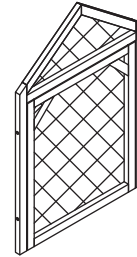

⑨ x01

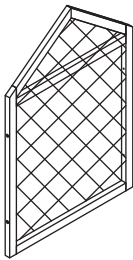

③ x01

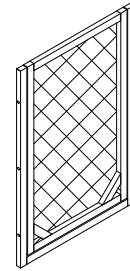

⑩ x01

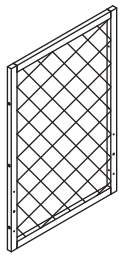

④ x01

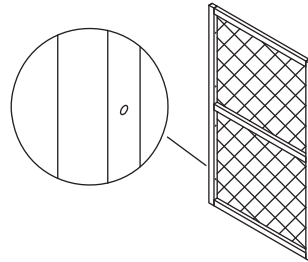

⑪ x02

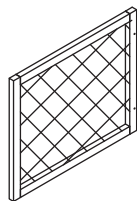

⑤ x02

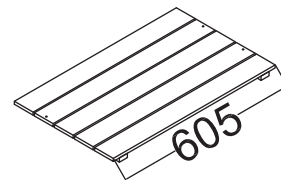

⑫ x01

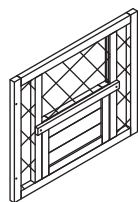

⑥ x02

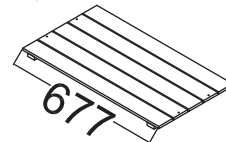

⑬ x06

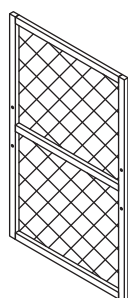

⑦ x02

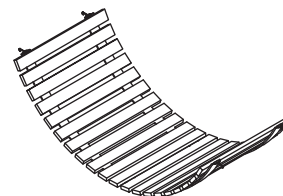

⑭ x02

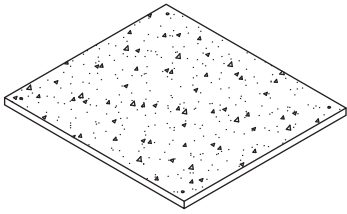

15 x02

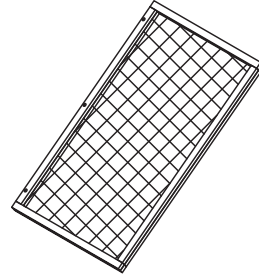

22 x01

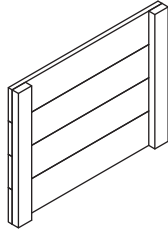

16 x02

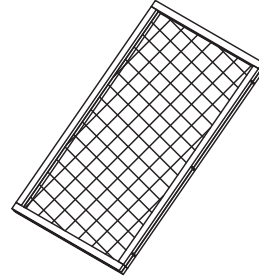

23 x02

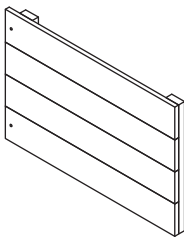

17 x02

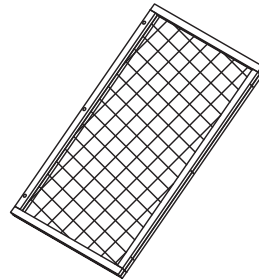

24 x01

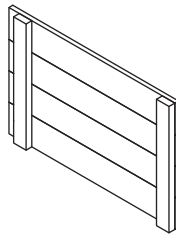

18 x02

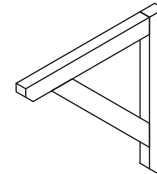

25 x14

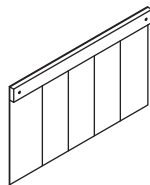

19 x02

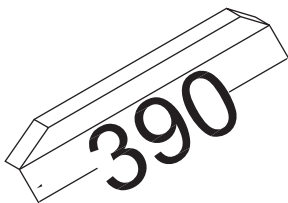
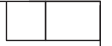



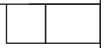

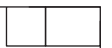

20 x06

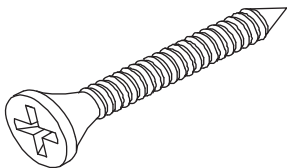
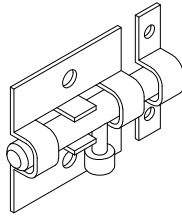
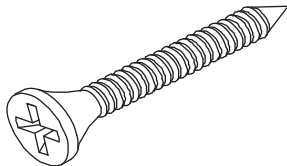
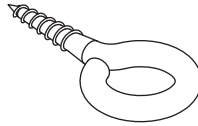
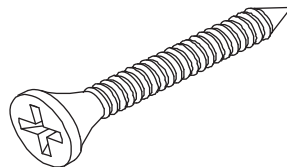

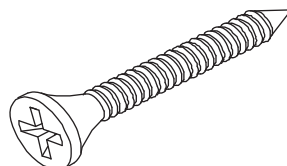
21 x12

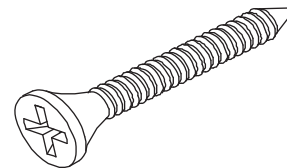

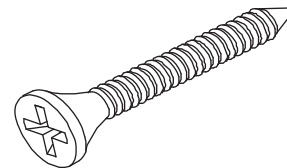
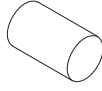
 <p>A x78+2(spare)</p> <p>M3.5*60</p>	 <p>F x02</p>
 <p>B x56+2(spare)</p> <p>M3.5*40</p>	 <p>G x10+1(spare)</p>
 <p>C x36+2(spare)</p> <p>M3.5*35</p>	 <p>H x02</p>
 <p>D x48+2(spare)</p> <p>M3*30</p>	 <p>I x01</p>
 <p>E x16+1(spare)</p> <p>M3*16</p>	 <p>J x04</p>
 <p>K x14+1(spare)</p>	

EN_ Do not confuse similar screws.
FR_ Ne pas confondre des vis similaires.
ES_ No confunda tornillos similares.
PT_ Não confundir parafusos semelhantes.
DE_ Verwechseln Sie ähnliche Schrauben nicht.
IT_ Non confondere le viti simili.

NOTE

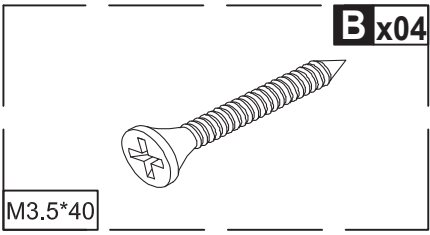
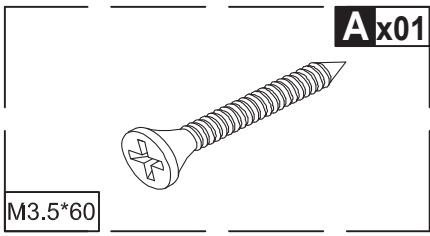

8

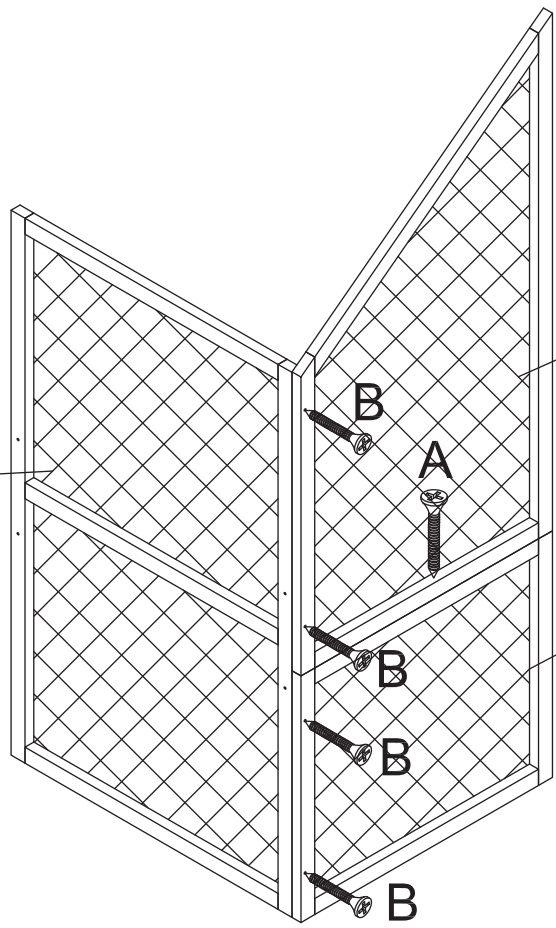

2

5

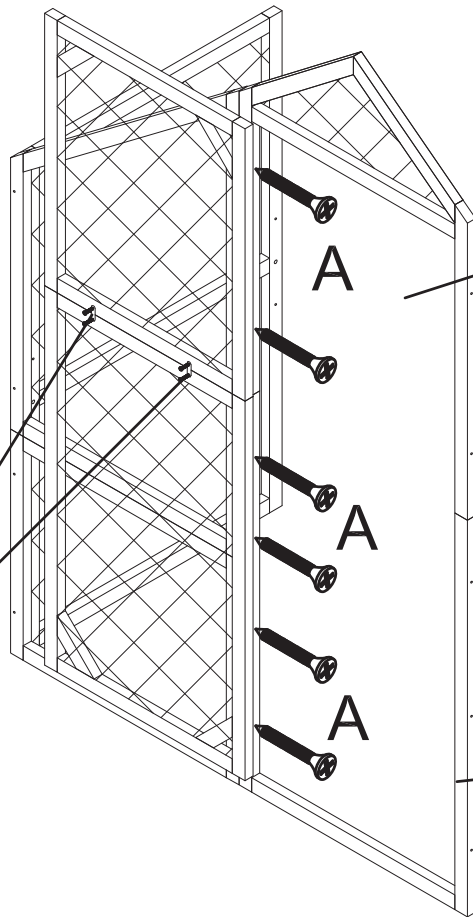
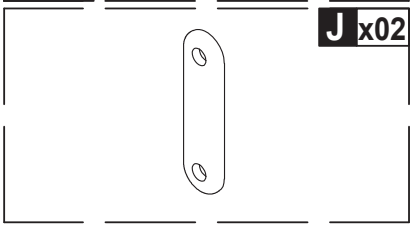
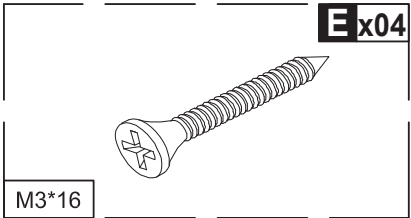
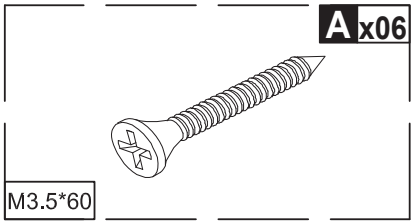

9

10

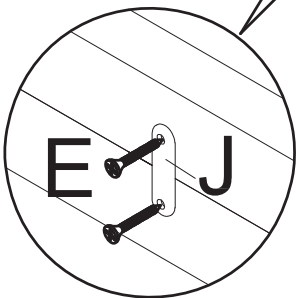

Ax01

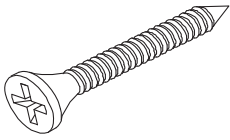

M3.5*60

Bx04

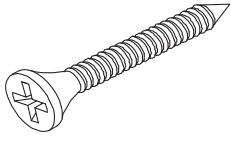

M3.5*40

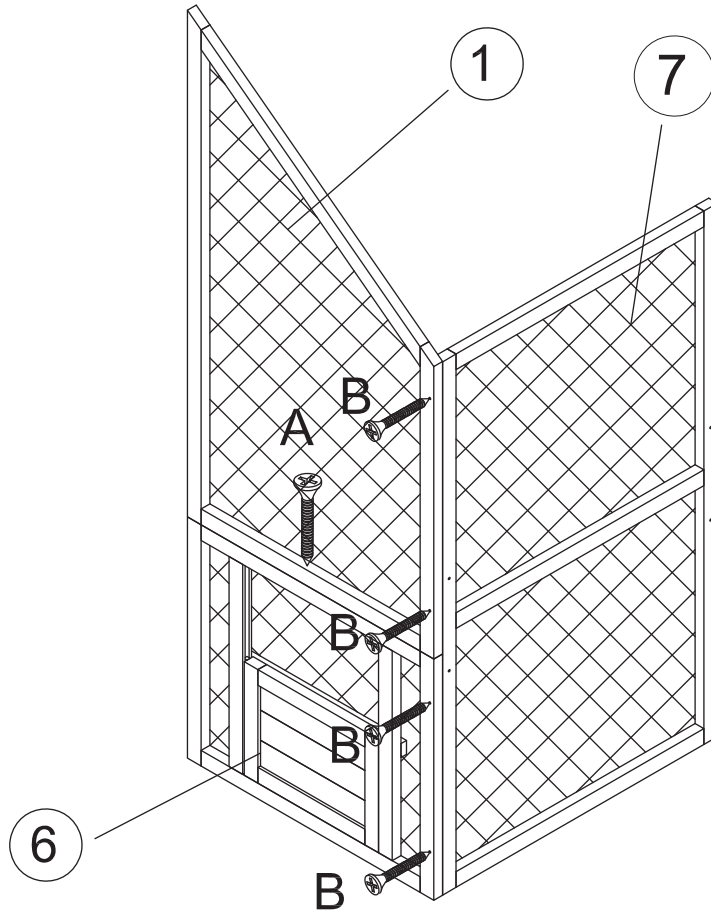

Ax06

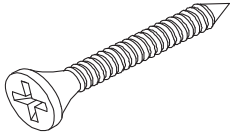

M3.5*60

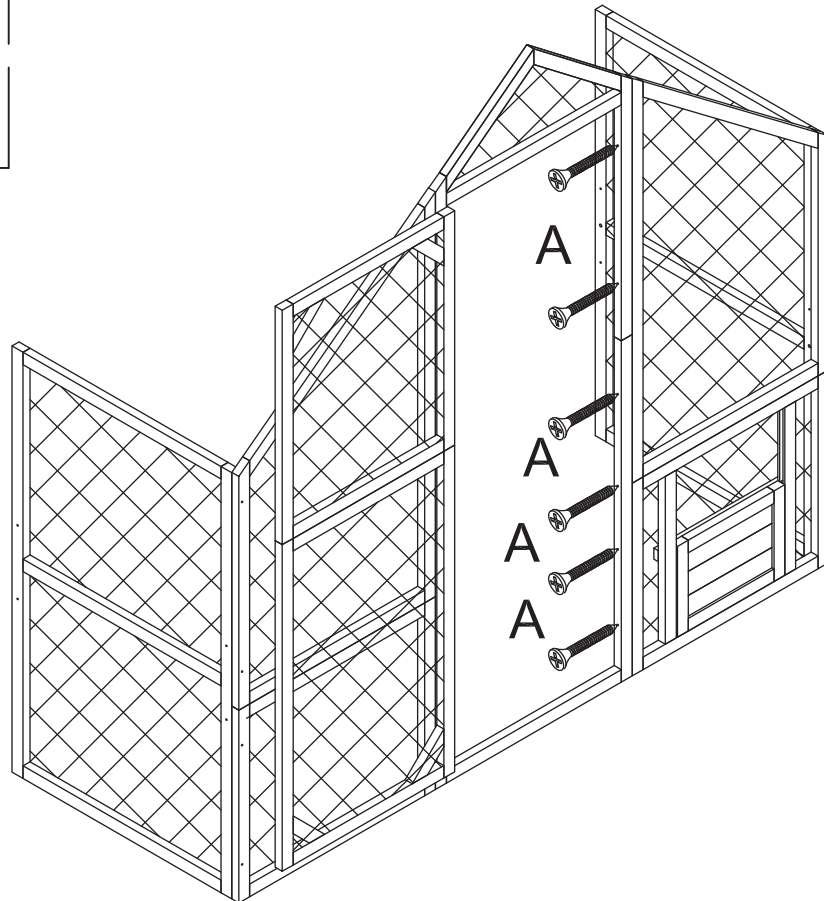

Ax12

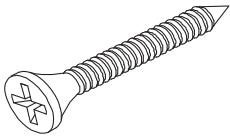

M3.5*60

Ex08

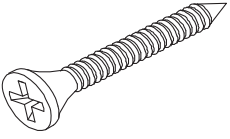

M3*16

Fx02

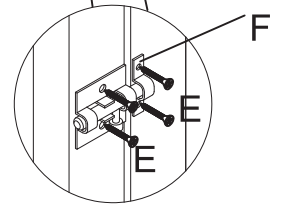
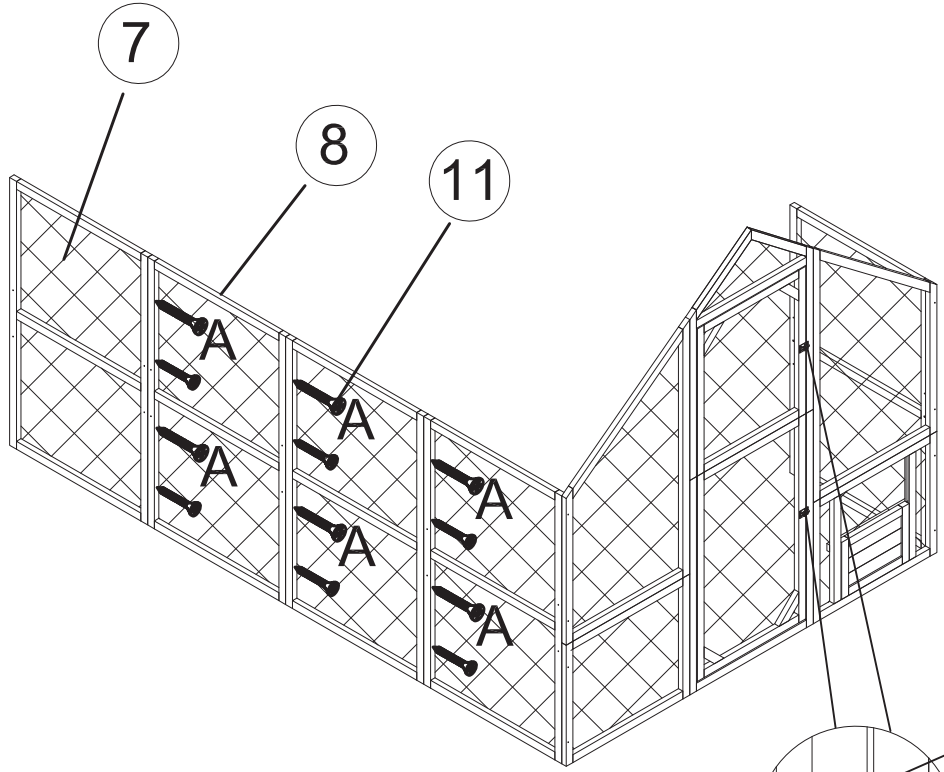
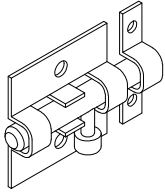

Kx14

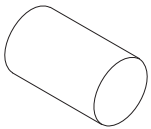

25

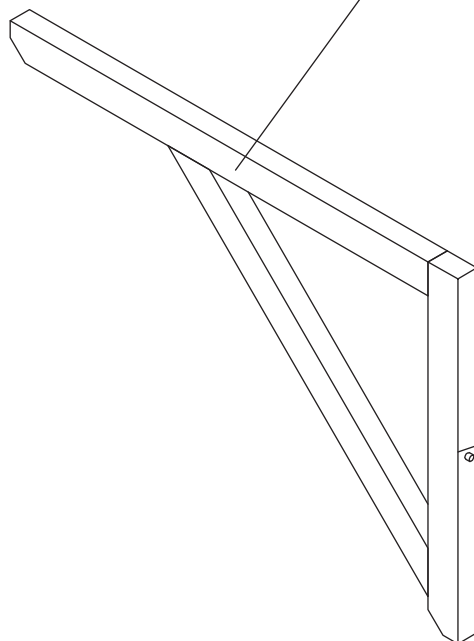

K

x14

Bx12

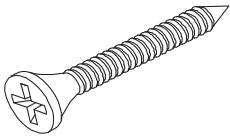

M3.5*40

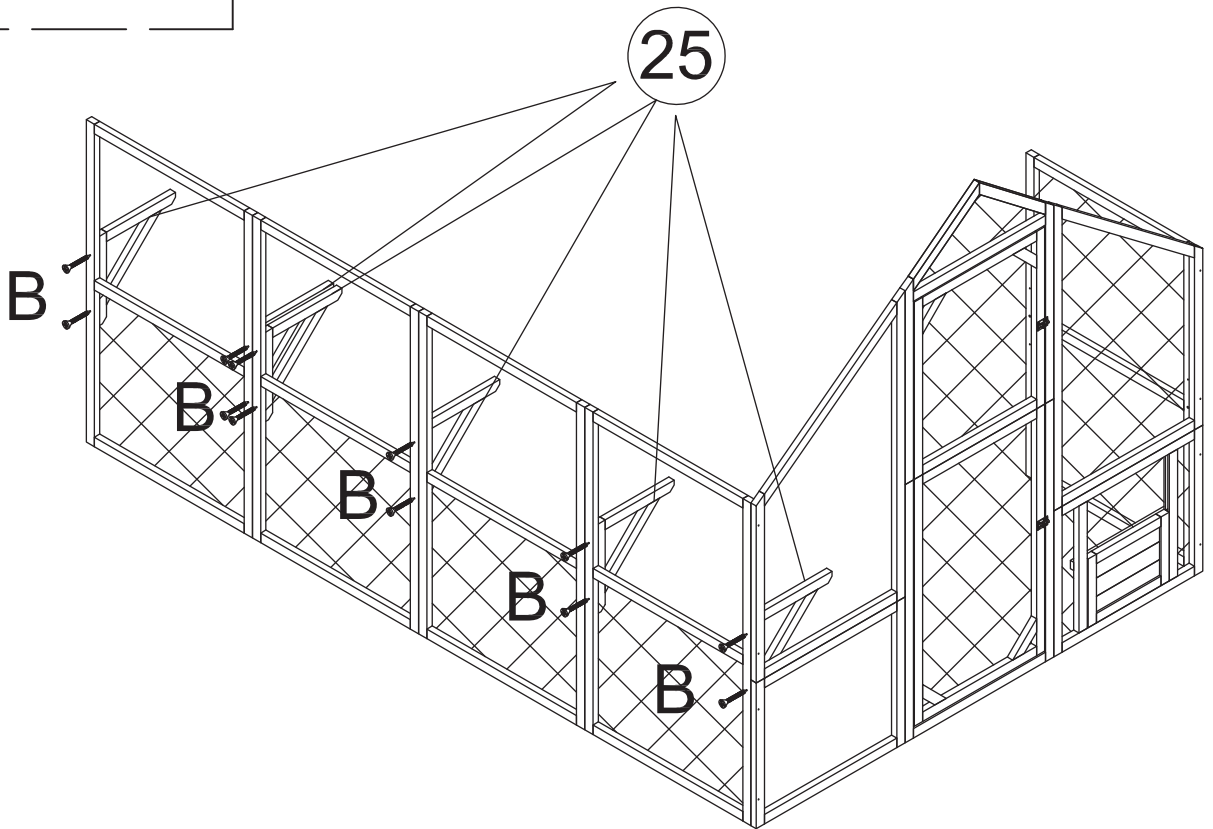

Gx04

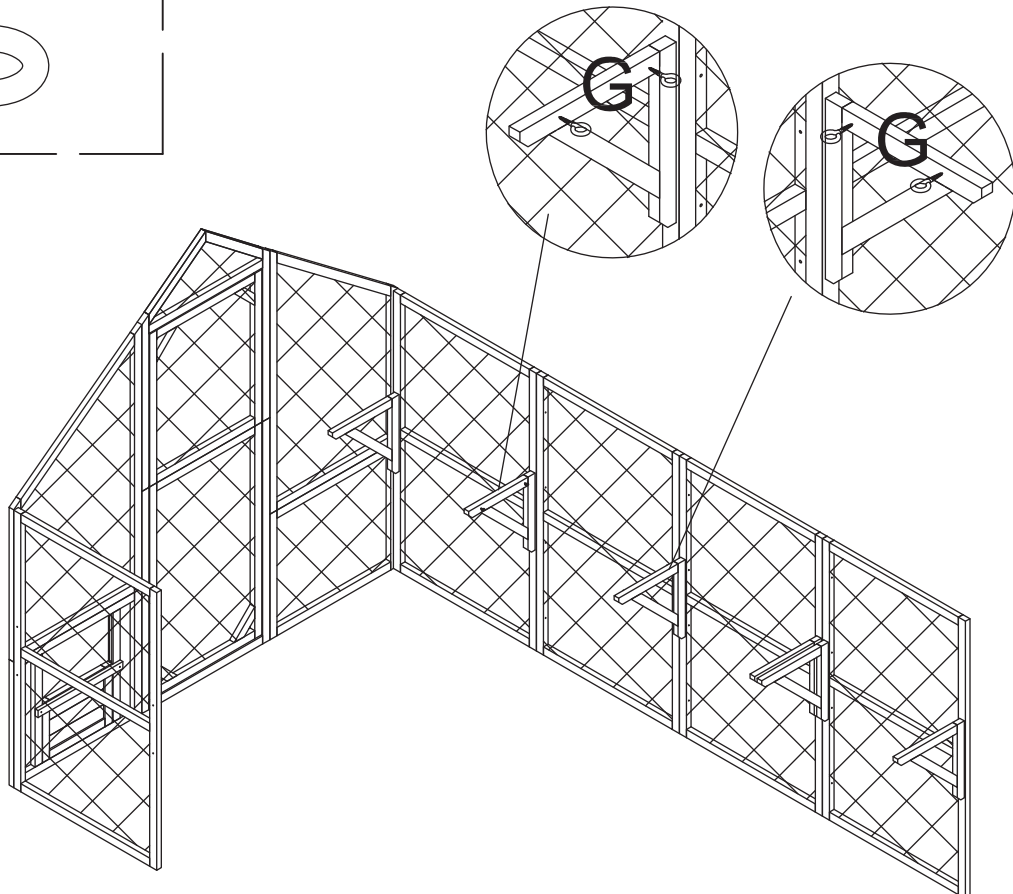
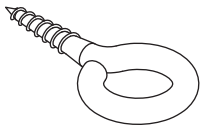

Dx12

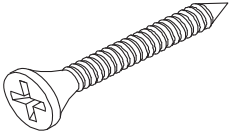

M3*30

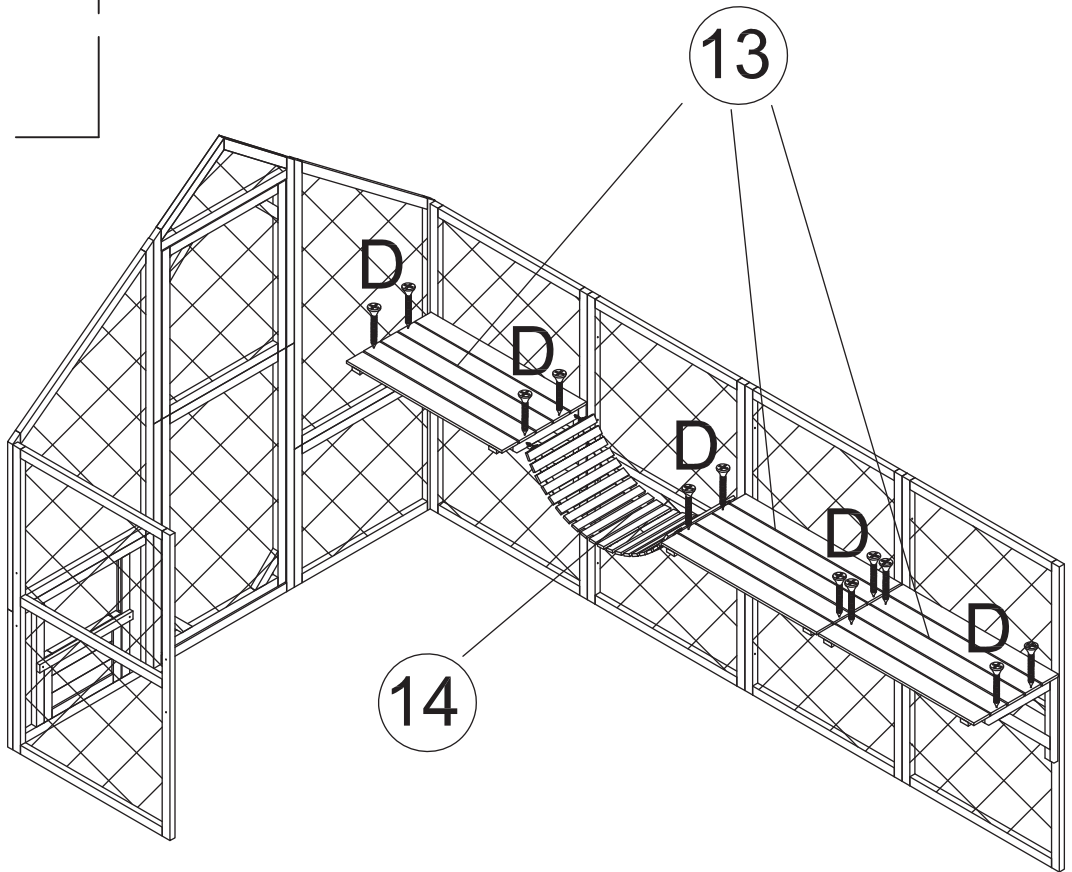

Ax12

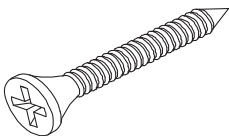

M3.5*60

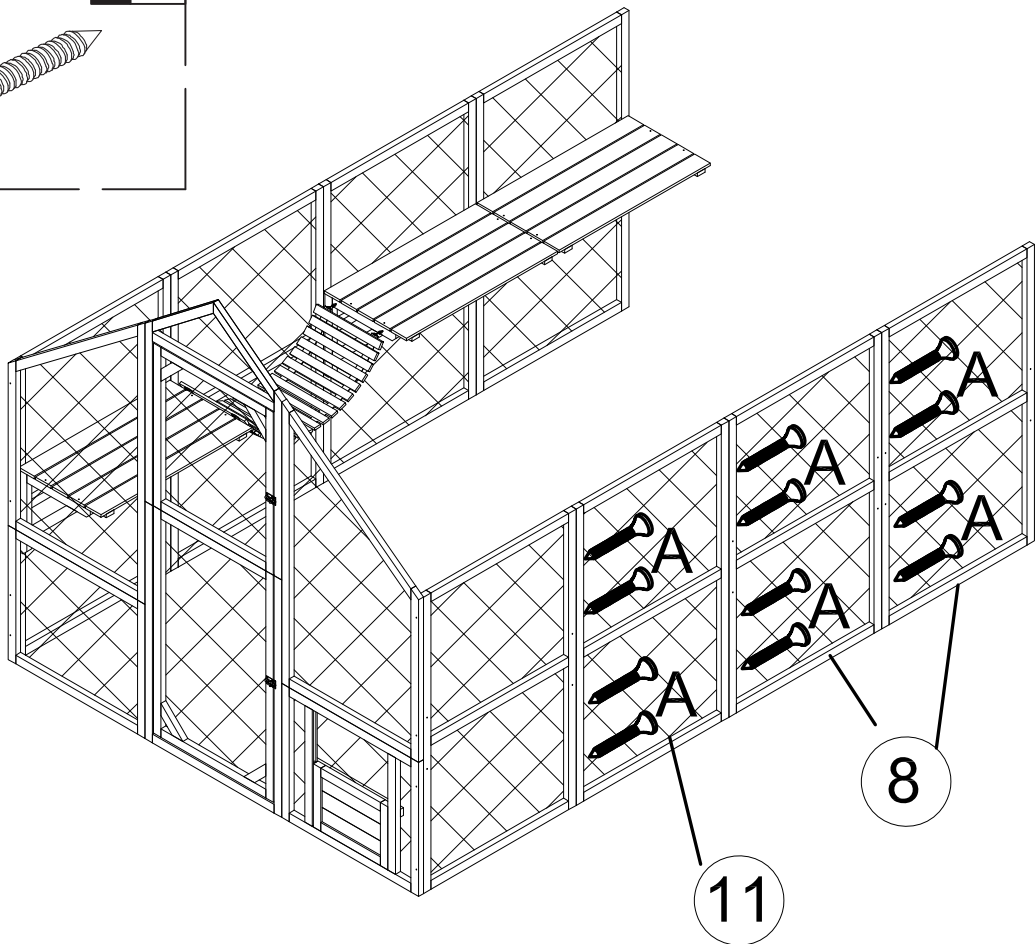

Bx12

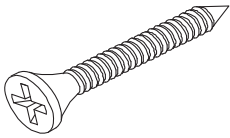

M3.5*40

Gx01

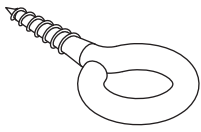

Hx01

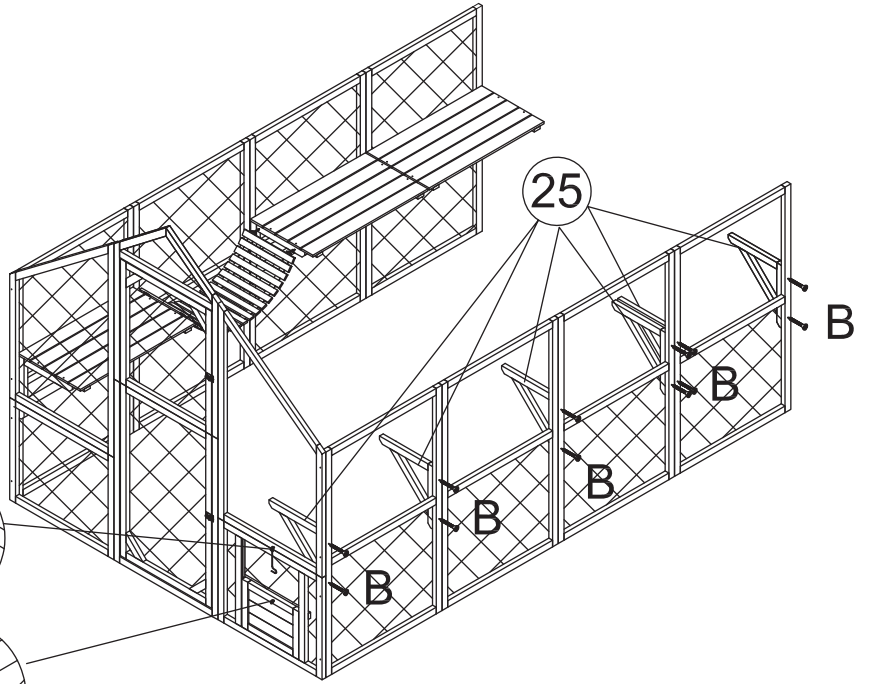
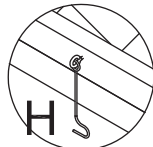

B

25

B

B

B

B

B

Gx04

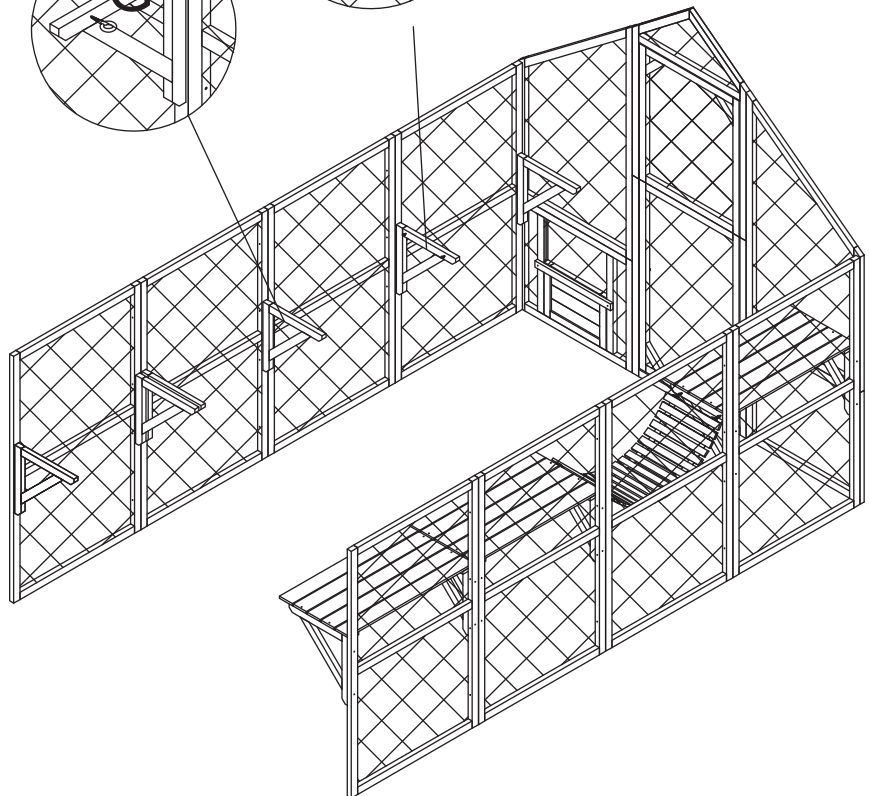
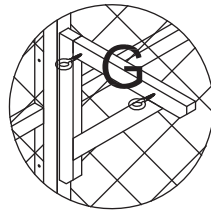
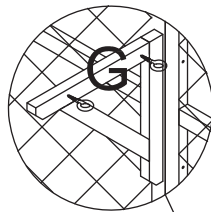
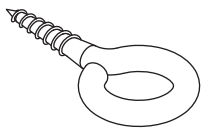

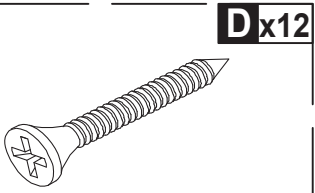

M3*30

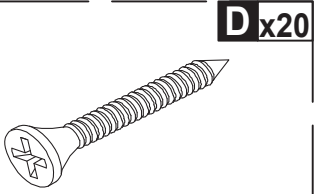
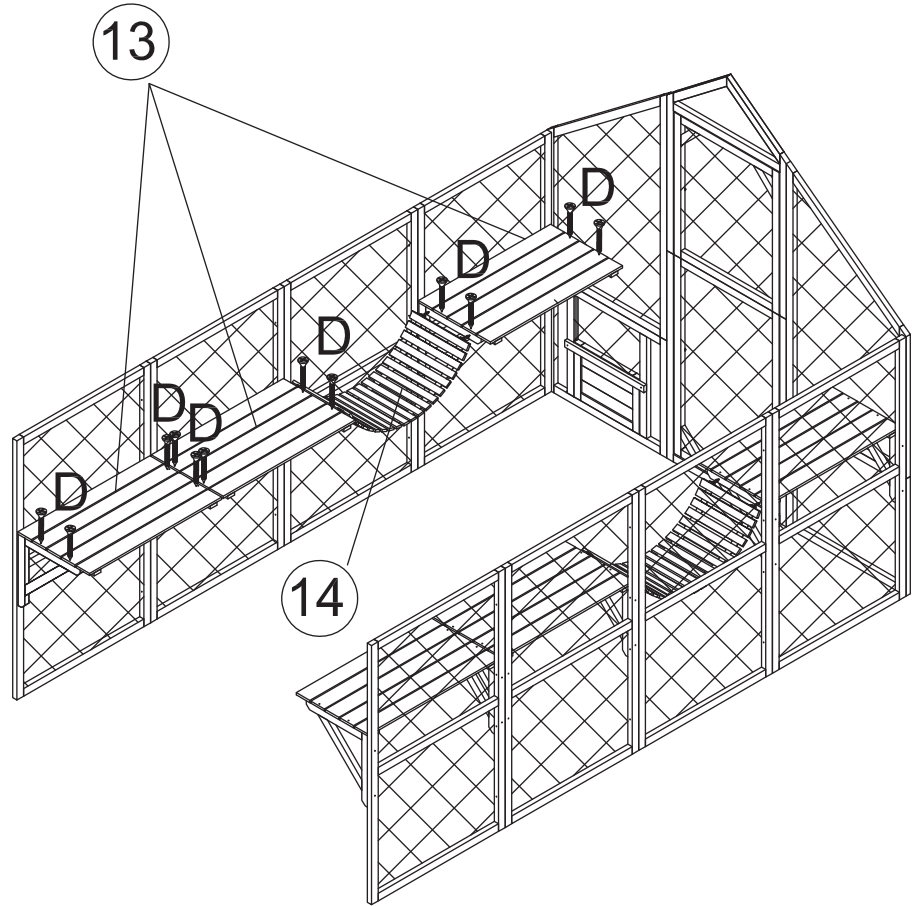

M3*30

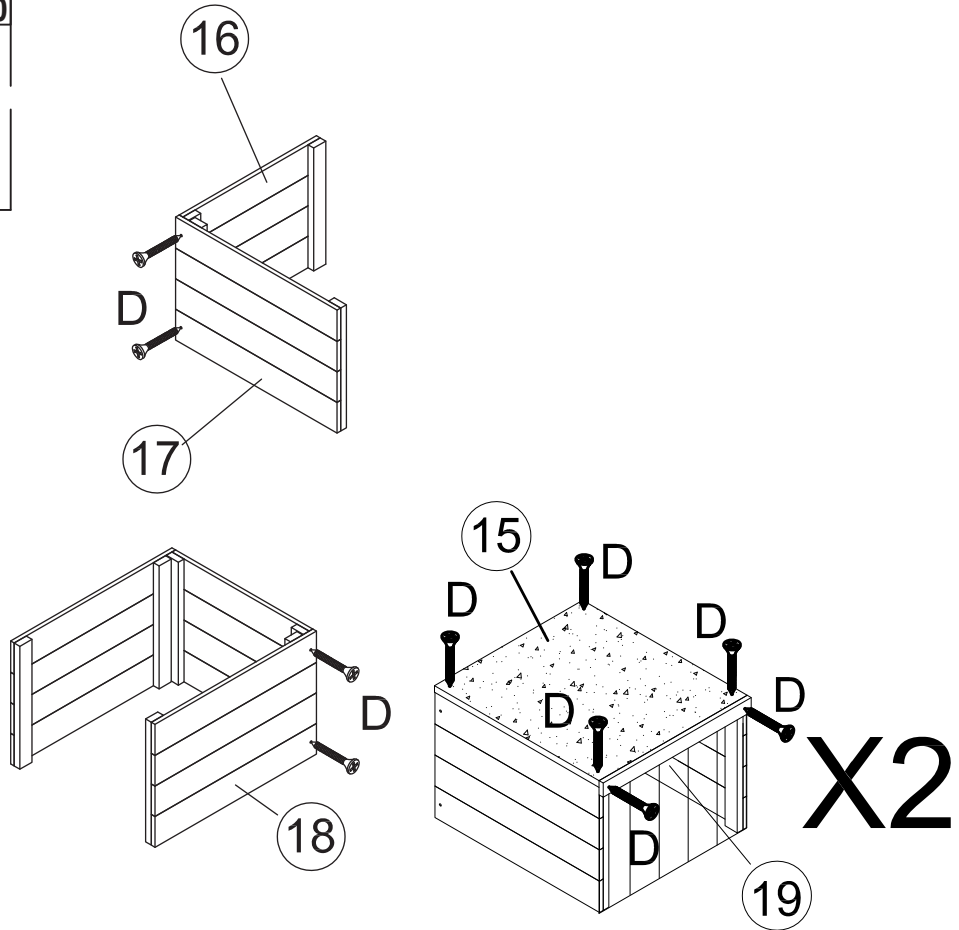

Ex04

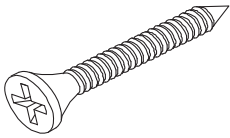

M3*16

Jx02

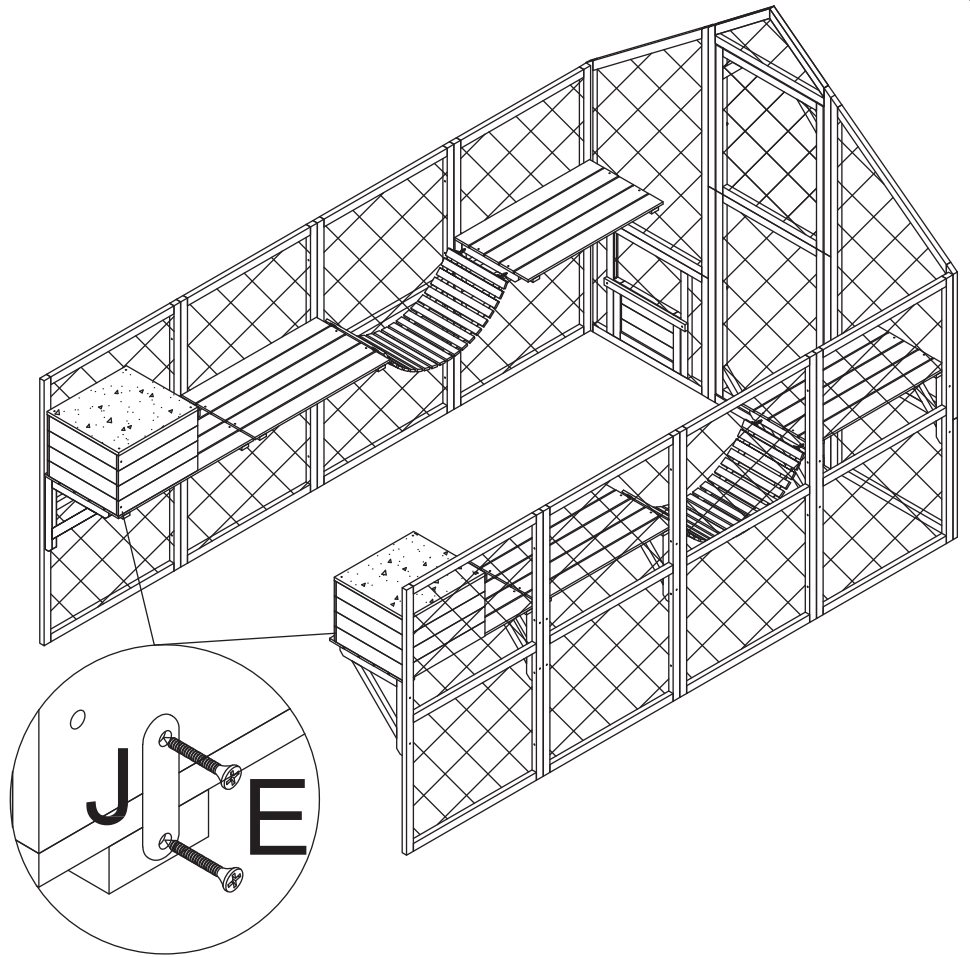

Ax01

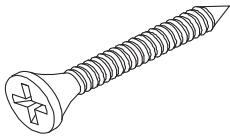

M3.5*60

Bx04

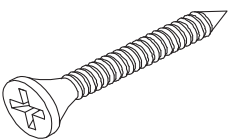

M3.5*40

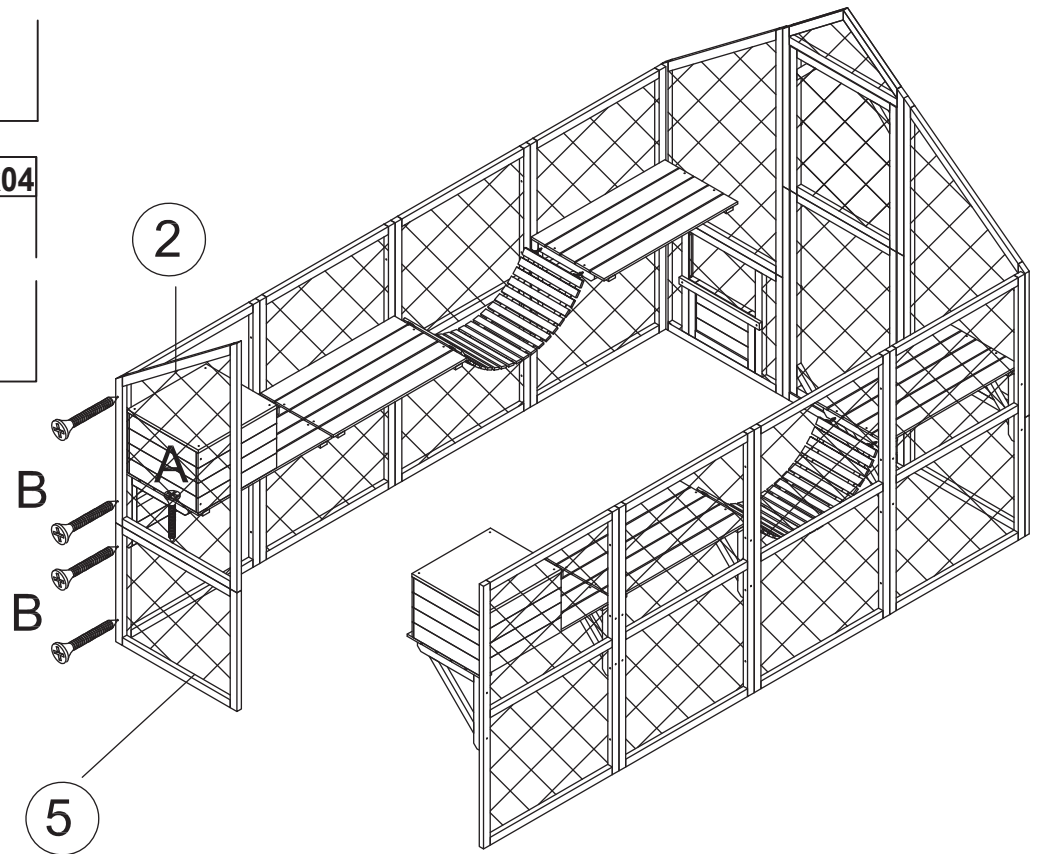

Bx04

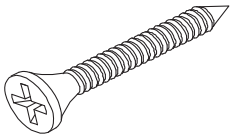

M3.5*40

Dx04

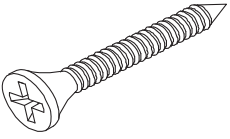

M3*30

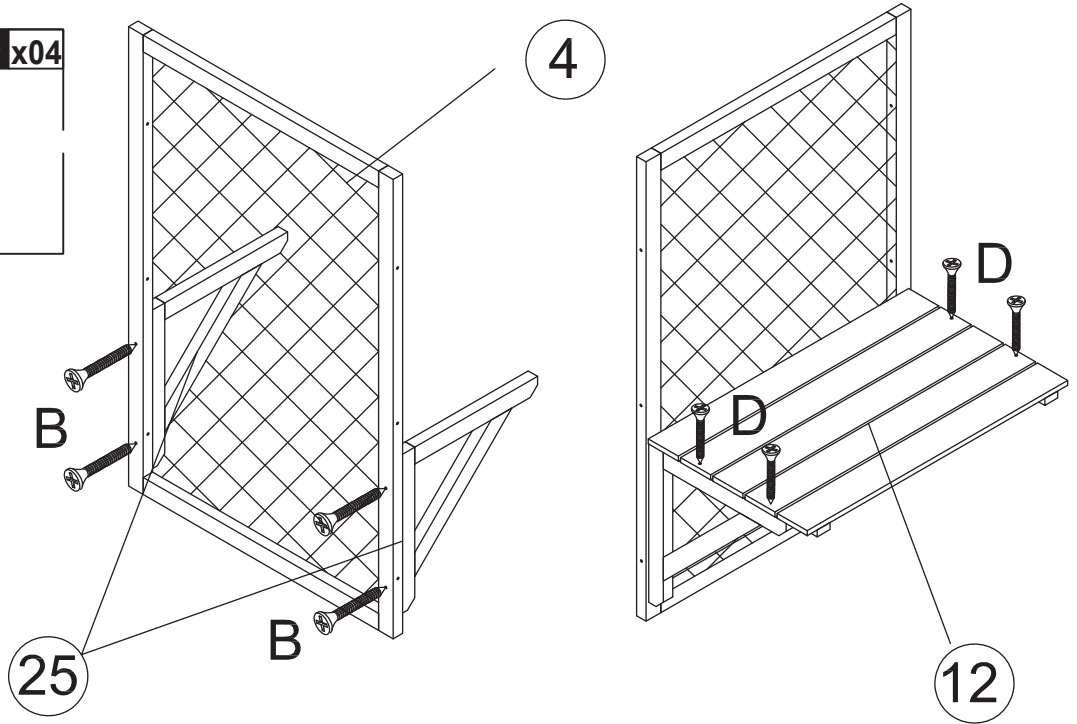

Ax06

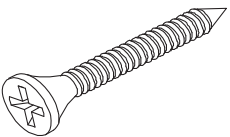

M3.5*60

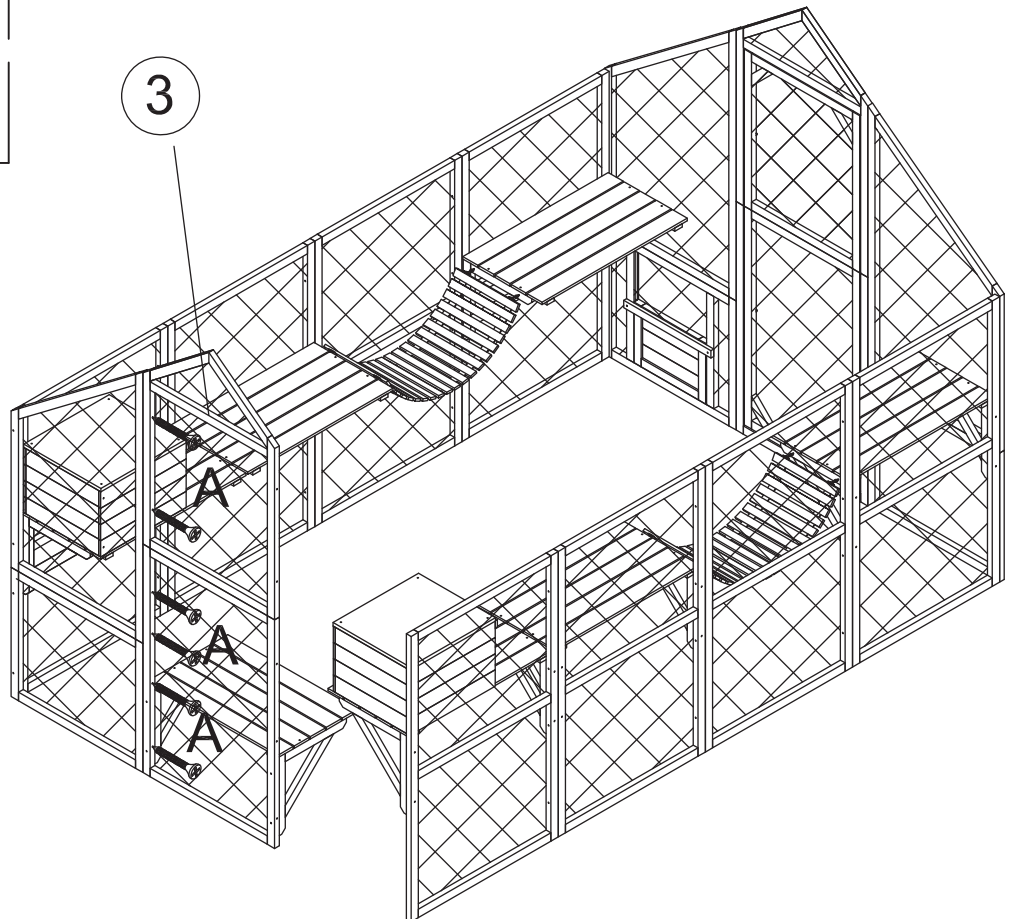

Ax07

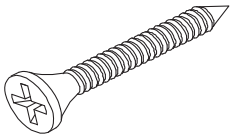

M3.5*60

Bx04

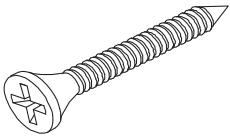

M3.5*40

Gx01

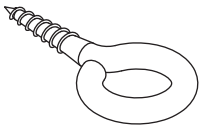

Hx01

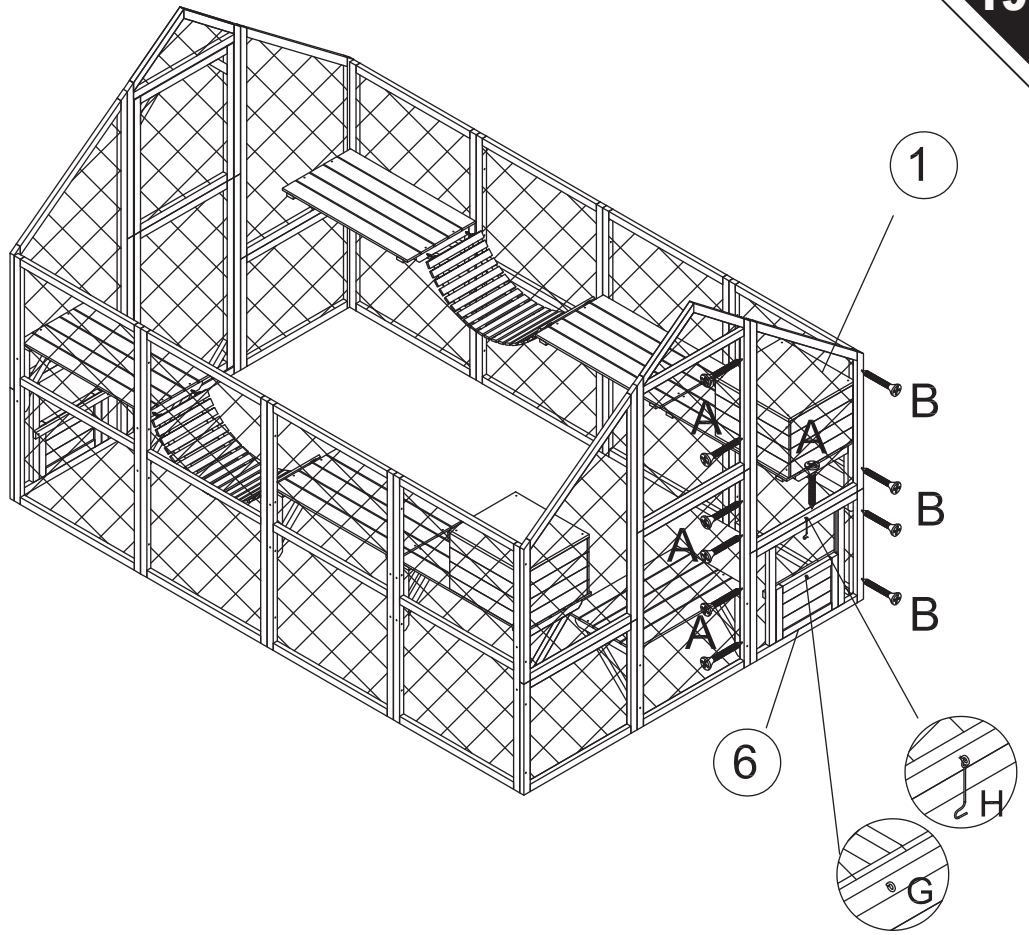
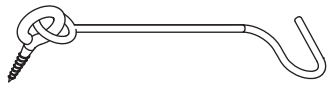

Ax18

M3.5*60

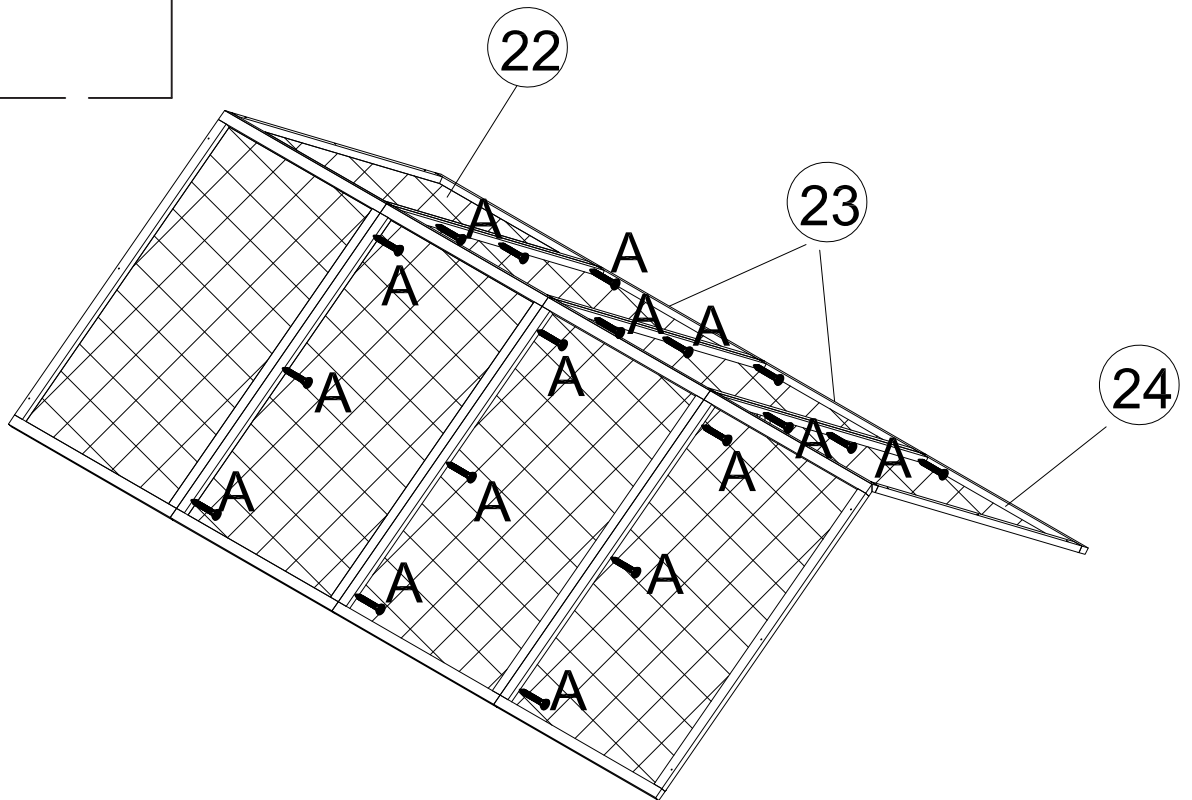

Ax04

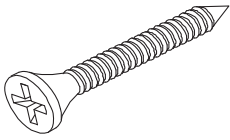

M3.5*60

Bx12

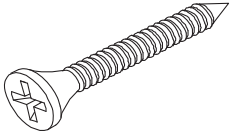

M3.5*40

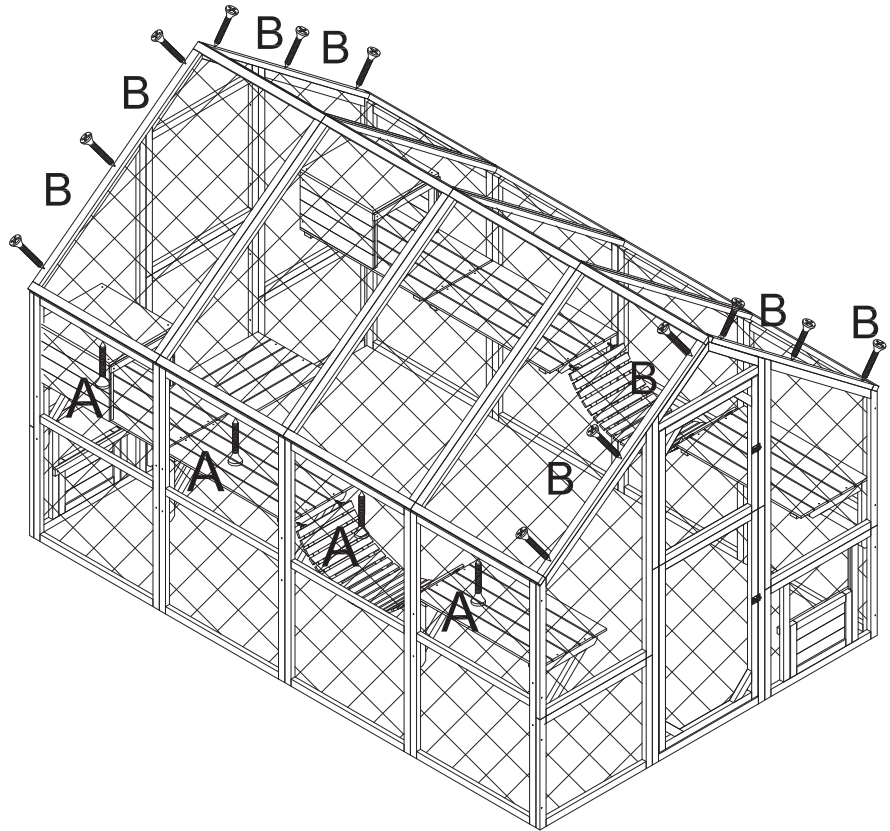

Ax04

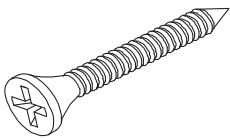

M3.5*60

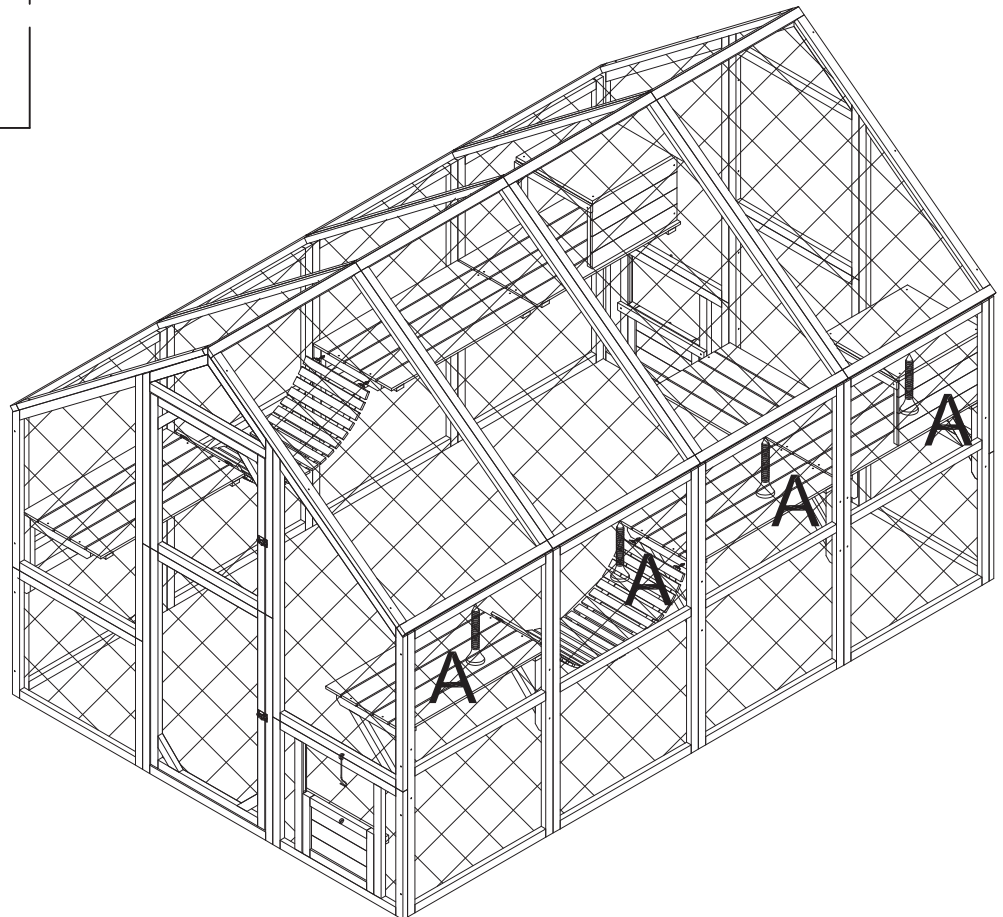

Cx36

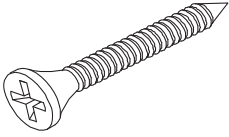

M3.5*35

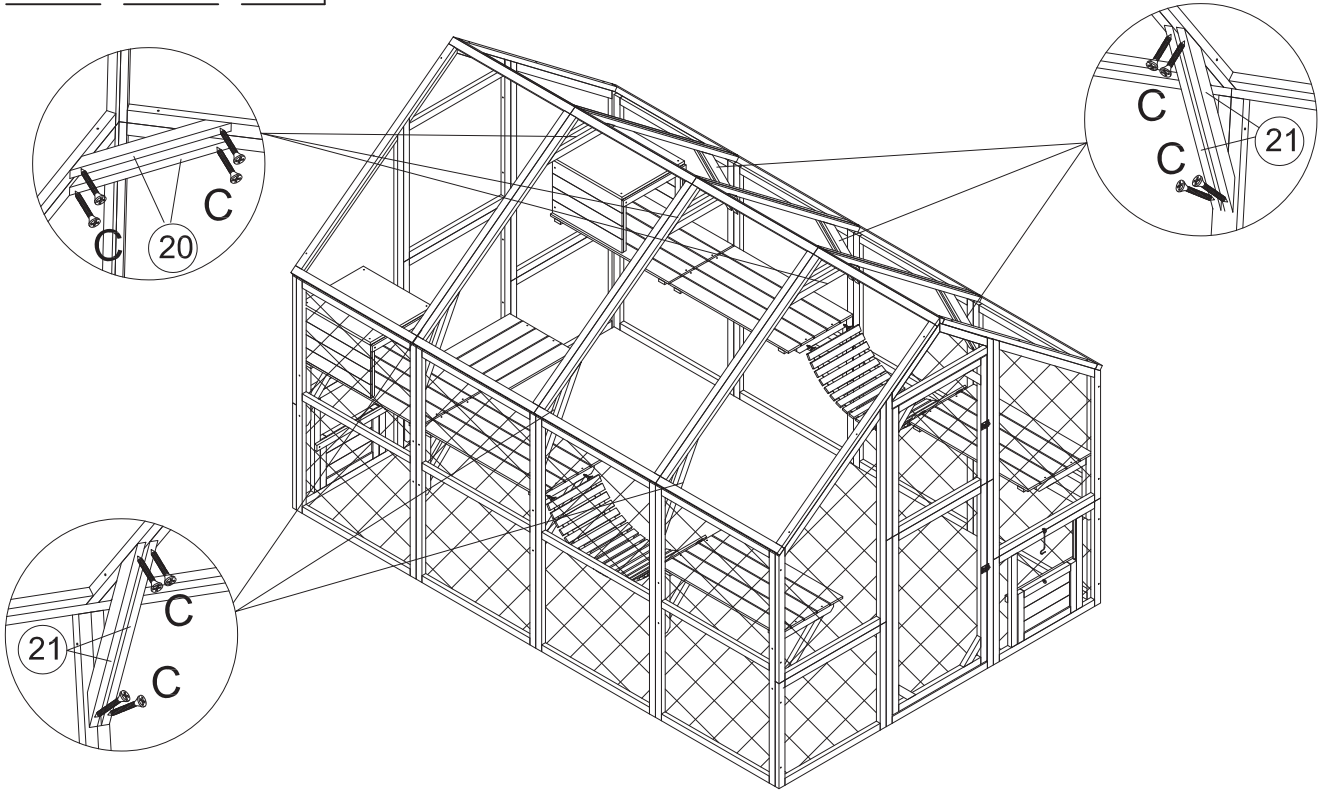

Ix01

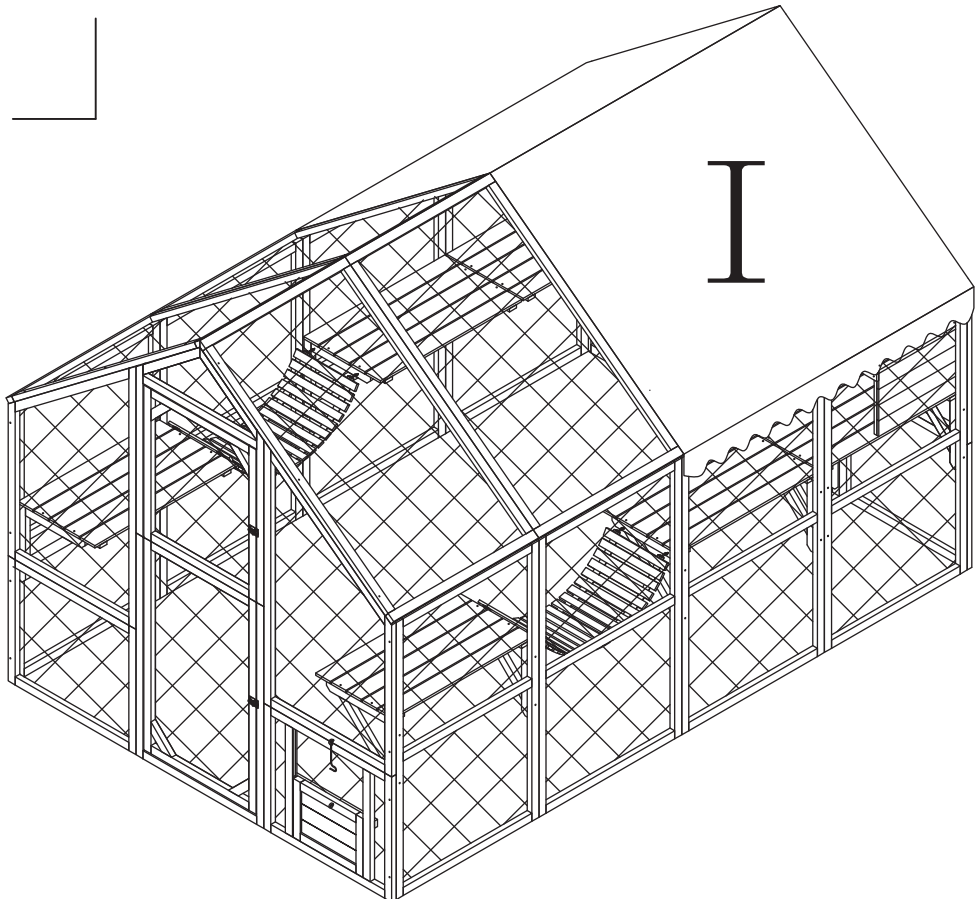

Done

If you have any questions, please contact our customer care center, Our contact details are below:

US

 001-877-644-9366

 customerservice@aosom.com

Imported by Aosom LLC
27150 SW Kinsman Rd Wilsonville, OR 97070 USA
MADE IN CHINA

If you have any questions, please contact our customer care center, Our contact details are below:

CA

 416-792-6088

 customerservice@aosom.ca

Imported by Aosom Canada Inc.
7270 Woodbine Avenue, Unit 307, Markham,
Ontario Canada L3R 4B9
MADE IN CHINA

Si vous avez la moindre question, veuillez contacter notre centre d'assistance à la clientèle, Nos coordonnées sont les suivantes:

 416-792-6088

 customerservice@aosom.ca

Importé par Aosom Canada Inc.
7270 Woodbine Avenue, unité 307,
Markham, Ontario Canada L3R 4B9
FABRIQUÉ EN CHINE

If you have any questions, please contact our customer care center, Our contact details are below:

UK

 0044-800-240-4004

 enquiries@mhstar.co.uk

IMPORTER ADDRESS:
MH STAR UK LTD
Unit 27, Perivale Park,
Horsenden lane South
Perivale, UB6 7RH
MADE IN CHINA

Si vous avez la moindre question, veuillez contacter notre centre d'assistance à la clientèle, Nos coordonnées sont les suivantes:

FR

 0033-1-84166106

 aosom@mhfrance.fr

Importé par/Fabricant/REP:
MH FRANCE
2 Rue Maurice Hartmann
92130 Issy Les Moulineaux
France
FABRIQUÉ EN CHINE

Wenn Sie Fragen haben, wenden Sie sich bitte an unser Kundendienstzentrum, Unsere Kontaktdaten stehen unten:

DE

 0049-0(40)-88307530

 service@aosom.de

ADRESSE DES IMPORTEURE/Hersteller/REP:
MH Handel GmbH
Wendenstraße 309
D-20537 Hamburg
Germany
IN CHINA HERGESTELLT

In caso di dubbio, si prega di contattare il nostro centro assistenza clienti, I nostri dettagli di contatto sono di seguito:

IT

 0039-0249471447

 clienti@aosom.it

IMPORTATO DA/Produttore/REP:
AOSOM Italy srl
Centro Direzionale Milanofiori
Strada 1 Palazzo F1
20057 Assago (MI)
P.I.: 08567220960
FATTO IN CINA

Si tiene alguna pregunta, comuníquese con nuestro Centro de Atención al Cliente, Nuestros datos de contacto son los siguientes:

ES

 0034-931294512

 atencioncliente@aosom.es

IMPORTADOR/Fabricante/REP:
SPANISH AOSOM, S.L.
C/ROC GROS, N°15.08550, ELS HOSTALET DE
BALENYÀ, SPAIN.
B66295775
HECHO EN CHINA

Se tiver alguma dúvida, por favor contacte o nosso Centro de Atendimento ao Cliente, Os nossos dados de contacto são os seguintes:

PT

 0034-931294512

 info@aosom.pt.

IMPORTADOR/Fabricante/REP:
SPANISH AOSOM, S.L.
C.ROC GROS N.15, 08550. ELS HOSTALET DE
BALENYÀ
FEITO NA CHINA



FR

**DONNEZ
OU
RECYCLEZ**



ASSOCIATION

OU



LIVRAISON

OU



DÉCHÈTERIE

Adresses sur quefairedemesdechets.fr