

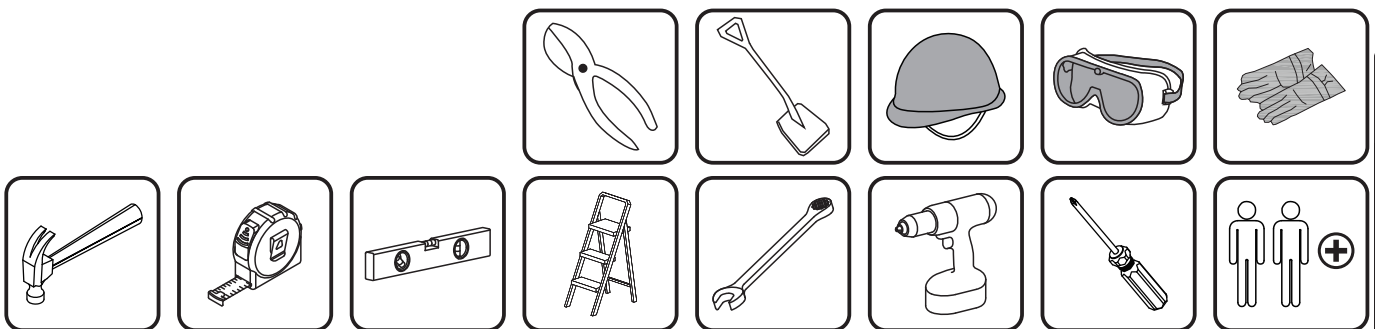

IN230900338V01_GL

845-946V00

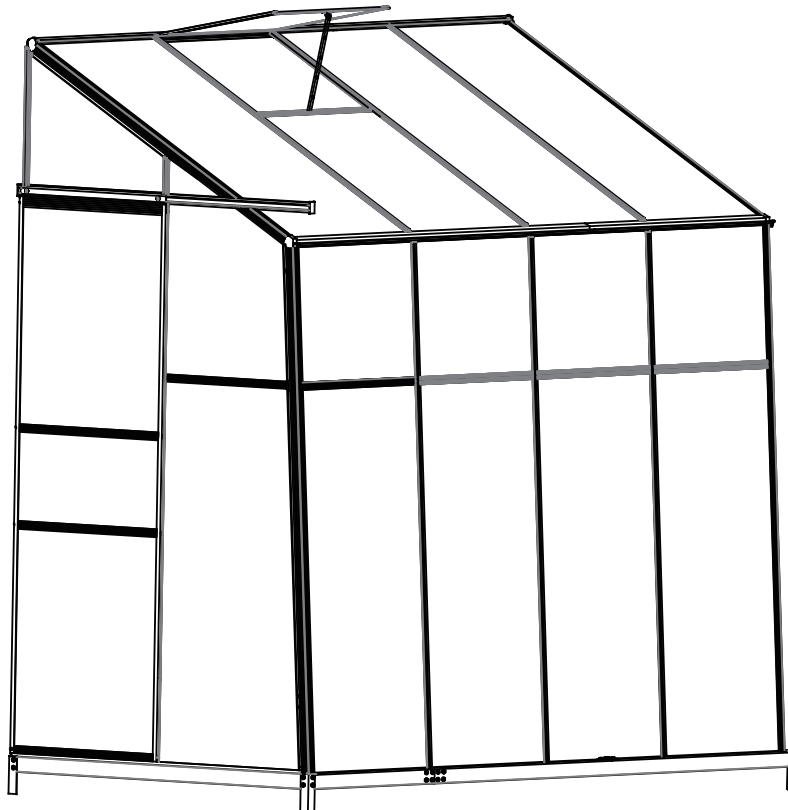

Tools Recommended

EN_IMPORTANT, RETAIN FOR FUTURE REFERENCE: READ CAREFULLY.

FR_IMPORTANT: A LIRE ATTENTIVEMENT ET À CONSERVER POUR CONSULTATION ULTÉRIEURE.

ES_IMPORTANTE, LEA Y GUARDE PARA FUTURAS REFERENCIAS.

PT_IMPORTANTE, RETER PARA REFERÊNCIA FUTURA: LEIA ATENTAMENTE.

DE_WICHTIG! SORGFÄLTIG LESEN UND FÜR SPÄTER NACHSCHLAGEN AUFBEWAHREN.

IT_IMPORTANTE! CONSERVARE IL PRESENTE MANUALE PER FUTURO RIFERIMENTO E LEGGERLO ATTENTAMENTE.

EN

TO PREVENT INJURY, READ AND UNDERSTAND THE GREENHOUSE ASSEMBLY INSTRUCTIONS BEFORE USE.

GENERAL SAFETY, WARNINGS AND PRECAUTIONS

KEEP WORK AREA CLEAN AND DRY.

Cluttered, damp or wet work areas invite injuries.

STAY ALERT. Watch what you are doing at all times. Use common sense. Do not use the greenhouse when you are tired or distracted from the job at hand. It is recommended to use gloves for assembling the greenhouse.

MAINTAIN THIS PRODUCT WITH CARE.

Keep the greenhouse clean and dry for better performance: maintenance should be performed regularly.

USE THE RIGHT PRODUCT FOR THE JOB.

Do not attempt to force a small product to do the work of a larger industrial product. There are certain applications for which the greenhouse was designed. It will do the job better and more safely in the manner for which it was intended. Do not modify the greenhouse and do not use the greenhouse for a purpose for which it was not intended.

MAINTAIN A SAFE WORKING ENVIRONMENT.

Keep the work area tidy. Make sure there is adequate surrounding workspace. Avoid high traffic areas. Always keep the work area free of obstructions, grease, oil, trash and other debris.

PROPER GREENHOUSE LOCATION.

Make sure the greenhouse is located on a flat level surface.

FR

POUR ÉVITER LES RISQUES DE BLESSURES, VEILLEZ LIRE ET COMPRENDRE LES INSTRUCTIONS DE MONTAGE DE LA SERRE AVANT DE L'UTILISER.

SÉCURITÉ GÉNÉRALE, AVERTISSEMENTS ET PRÉCAUTIONS

GARDER LA ZONE DE TRAVAIL PROPRE ET SÈCHE.

Les zones de travail encombrées, humides ou mouillées sont propices aux blessures.

RESTEZ VIGILANT. Surveillez ce que vous faites à tout moment. Faites preuve de bon sens. N'utilisez pas la serre lorsque vous êtes fatigué ou distrait du travail en cours. Il est recommandé d'utiliser des gants pour le montage de la serre.

ENTRETIENEZ CE PRODUIT AVEC SOIN.

Gardez la serre propre et sèche pour un meilleur rendement : l'entretien doit être effectué régulièrement.

UTILISEZ LE PRODUIT APPROPRIÉ POUR LE TRAVAIL À EFFECTUER.

N'essayez pas de forcer un petit produit à faire le travail d'un produit industriel plus important. La serre a été conçue pour certaines applications. Elle fera mieux le travail pour lequel elle a été conçue et de manière plus sûre. Ne modifiez pas la serre et n'utilisez pas la serre à des fins pour lesquelles elle n'a pas été conçue.

MAINTENIR UN ENVIRONNEMENT DE TRAVAIL SÛR.

Maintenez l'espace de travail en ordre. Assurez-vous que l'espace de travail environnant est adéquat. Évitez les zones à forte circulation. Maintenez la zone de travail toujours libre de tout obstacle, graisse, huile, déchets et autres débris.

EMPLACEMENT ADÉQUAT DE LA SERRE.

Veillez à ce que la serre soit située sur une surface plane et de niveau.

ES

PARA PREVENIR LESIONES, LEA Y COMPRENDA LAS INSTRUCCIONES DE MONTAJE DEL INVERNADERO ANTES DE USARLO.

SEGURIDAD GENERAL, ADVERTENCIAS Y PRECAUCIONES

MANTENGA EL ÁREA DE TRABAJO LIMPIA Y SECA.

Las áreas de trabajo desordenadas, húmedas o mojadas pueden provocar lesiones. **MANTÉNGASE ALERTA.** Vigile lo que está haciendo en todo momento con el conocimiento común. No use el invernadero cuando esté cansado o distraído del trabajo en cuestión. Se recomienda utilizar guantes para montar el invernadero.

MANTENGA ESTE PRODUCTO CON CUIDADO.

Mantenga el invernadero limpio y seco para un mejor rendimiento: el mantenimiento debe realizarse con regularidad.

USE EL PRODUCTO ADECUADO PARA EL TRABAJO.

No intente forzar a un producto pequeño a hacer el trabajo que debe hacerse por un producto industrial más grande. Existen determinadas aplicaciones para las que se ha diseñado el invernadero. Puede hacer el trabajo mejor y con más seguridad si se usa en la manera para la que fue diseñado. No modifique el invernadero y no lo utilice para fines para los que no fue diseñado.

MANTENGA UN AMBIENTE DE TRABAJO SEGURO.

Mantenga el área de trabajo ordenada. Asegúrese de que haya un espacio de trabajo circundante adecuado. No lo use en las áreas de mucho tráfico. Mantenga siempre el área de trabajo libre de obstrucciones, grasa, aceite, basura y otros desechos.

UBICACIÓN APROPIADA DEL INVERNADERO.

Asegúrese de que el invernadero esté ubicado en una superficie plana y nivelada.

PT

SEGURANÇA GERAL, AVISOS E PRECAUÇÕES

MANTER A ÁREA DE TRABALHO LIMPA E SECA.

As áreas de trabalho desorganizadas, húmidas ou molhadas provocam lesões. **ATENÇÃO:** Esteja sempre atento ao que está a fazer. Use comum sentido. Não utilizar a estufa quando estiver esgotado ou distraído do trabalho em questão. Recomenda-se o uso de luvas para montar a estufa.

MANTENHA ESTE PRODUTO COM PRUDÊNCIA.

Mantenha a estufa limpa e seca para um melhor desempenho: a manutenção deve ser feita regularmente.

UTILIZAR O PRODUTO CERTO PARA O FUNCIONAMENTO.

Não tentar forçar um produto pequeno a fazer o funcionamento de um produto industrial maior. Existem certas aplicações para as quais o estufa foi concebida. Fará o trabalho de forma melhor e mais segura da forma a que foi concebido. Não modificar a estufa e não utilizar a estufa para um fim para o qual não foi concebida.

MANTER UM AMBIENTE DE TRABALHO SEGURO.

Manter a área de trabalho arrumada. Certificar-se de que existe um ambiente de trabalho adequado espaço o suficiente. Manter sempre a área de trabalho livre de obstruções, gorduras, óleo, lixo e outros detritos.

LOCALIZAÇÃO ADEQUADA DA ESTUFA.

Certifique-se de que a estufa está localizada numa superfície de nivelada.

DE

Um Verletzungen zu vermeiden, lesen und verstehen Sie bitte vor dem Gebrauch die Anweisungen zur Montage des Gewächshauses.

Allgemeine Sicherheit, Warnhinweise und Vorsichtsmaßnahmen

Halten Sie Arbeitsbereich sauber und trocken .

Überfüllte, feuchte oder nasse Arbeitsbereiche können zu Verletzungen führen. **WACHSAM BLEIBEN.** Beobachten Sie jederzeit, was Sie tun. Verwenden Sie gesunden Menschenverstand. Verwenden Sie das Gewächshaus nicht, wenn Sie müde oder von der anstehenden Aufgabe abgelenkt sind. Es wird empfohlen, für die Montage des Gewächshauses Handschuhe zu tragen.

Behalten Sie dieses Produkt mit Pflege

Halten Sie das Gewächshaus sauber und trocken, um eine bessere Leistung zu erzielen: Regelmäßige Wartungsarbeiten sollten durchgeführt werden.

Verwenden Sie das richtige Produkt für den Job

Versuchen Sie nicht, ein kleines Produkt zu zwingen, die Arbeit eines größeren Industrieprodukts zu erledigen. Es gibt bestimmte Anwendungen, für die das Gewächshaus konzipiert wurde. Es wird die Arbeit besser und sicherer in der Weise erledigen, für die es bestimmt war. Ändern Sie das Gewächshaus nicht und verwenden Sie es nicht für Zwecke, für die es nicht vorgesehen war.

Sorgen Sie für ein sicheres Arbeitsumfeld.

Halten Sie den Arbeitsbereich sauber und ordentlich. Stellen Sie sicher, dass Sie genügend Arbeitsfläche um sich haben. Vermeiden Sie stark frequentierte Bereiche. Halten Sie den Arbeitsbereich immer frei von Hindernissen, Fett, Öl, Müll und anderen Fremdkörpern.

Richtige Gewächshauslage.

Stellen Sie sicher, dass sich das Gewächshaus auf einer ebenen Fläche befindet.

IT

PER PREVENIRE LESIONI, LEGGETE E COMPRENDETE LE ISTRUZIONI DI ASSEMBLAGGIO DELLA SERRA PRIMA DELL'USO.

SICUREZZA GENERALE, AVVERTENZE E PRECAUZIONI

MANTENETE L'AREA DI LAVORO PULITA E ASCIUTTA.

Le aree di lavoro disordinate, umide o bagnate potrebbero provocare lesioni. **STAI ATTENTO.** Stai attento su cosa stai facendo in ogni momento. Usa il senso comune e non usare la serra quando sei stanco o distratto nel lavoro da svolgere. Si consiglia di utilizzare i guanti per l'assemblaggio della serra.

MANTENETE QUESTO PRODOTTO CON CURA.

Mantieni la serra pulita e asciutta per prestazioni migliori: la manutenzione deve essere eseguita regolarmente.

UTILIZZATE IL PRODOTTO GIUSTO PER IL LAVORO.

Non tentare di forzare un prodotto piccolo a svolgere un lavoro di un prodotto industriale più grande. Ci sono alcune applicazioni per le quali il prodotto è stato progettato. Il prodotto funzionerà meglio e più sicuro nel modo per cui è stato progettato. Non modificare la serra e non utilizzare la serra per scopi per i quali non è stata concepita.

MANTENETE UN AMBIENTE DI LAVORO SICURO.

Tieni in ordine l'area di lavoro. Assicurati che ci sia uno spazio di lavoro circostante adeguato. Evita le zone di molto traffico. Mantieni sempre l'area di lavoro libera da ostruzioni, grasso, olio, rifiuti e altri detriti.

POSIZIONE ADEGUATA DELLA SERRA.

Assicurati che la serra si trovi su una superficie piana e livellata.

EN_ ABOUT THIS MANUAL LEGENDS
FR_ À PROPOS DE CE MANUEL LÉGENDES
ES_ SOBRE ESTE MANUAL LEYENDAS
PT_ SOBRE ESTE MANUAL LEGENDAS
DE_ ÜBER DIESES HANDBUCH LEGENDEN
IT_ SULLE LEGGENDE DI QUESTO MANUALE



EN_ Steps. Follow the steps in alphabetic order, from Step A to Step B, etc.
FR_ Les étapes. Suivez les étapes dans l'ordre alphabétique, de l'étape A à l'étape B, etc.
ES_ Pasos. Siga los pasos en orden alfabético, del Paso A al Paso B, etc.
PT_ Passos. Siga os passos por ordem alfabética, do passo A ao passo B, etc.
DE_ Schritte. Befolgen Sie die Schritte in alphabetischer Reihenfolge, von Schritt A zu Schritt B usw.
IT_ Passi. Seguire le fasi in ordine alfabetico, dalla fase A alla fase B, ecc.



EN_ Part No. Each part is labeled with its Part No.
FR_ Numéro de pièce Chaque pièce est étiquetée avec son numéro de pièce.
ES_ N° de pieza Cada pieza está etiquetada con su N° de pieza.
PT_ N.º de peça Cada peça está identificada com o seu N.º de peça.
DE_ Teile-Nr. Jedes Teil ist mit seiner Teile-Nr. beschriftet.
IT_ Ogni pezzo è etichettato con il suo codice articolo.



EN_ If you meet some difficult during the assembly, please loosen the relevant screws for adjustment first, and then tighten the screws again.
FR_ Si vous rencontrez des difficultés lors du montage, veuillez d'abord desserrer les vis correspondantes pour les ajustements, puis les resserrer.
ES_ Si encuentra alguna dificultad durante el montaje, primero afloje los tornillos correspondientes para ajustar, y luego vuelva a apretarlos.
PT_ Se encontrar alguma dificuldade durante a montagem, por favor solte os parafusos relevantes para ajuste primeiro, e depois aperte novamente os parafusos.
DE_ Wenn Sie während der Montage auf Schwierigkeiten stoßen, lösen Sie bitte zuerst die entsprechenden Schrauben zur Einstellung und ziehen Sie die Schrauben dann wieder fest.
IT_ In caso di difficoltà durante il montaggio, allentare innanzitutto le viti prima della regolazione, quindi stringere nuovamente le viti.

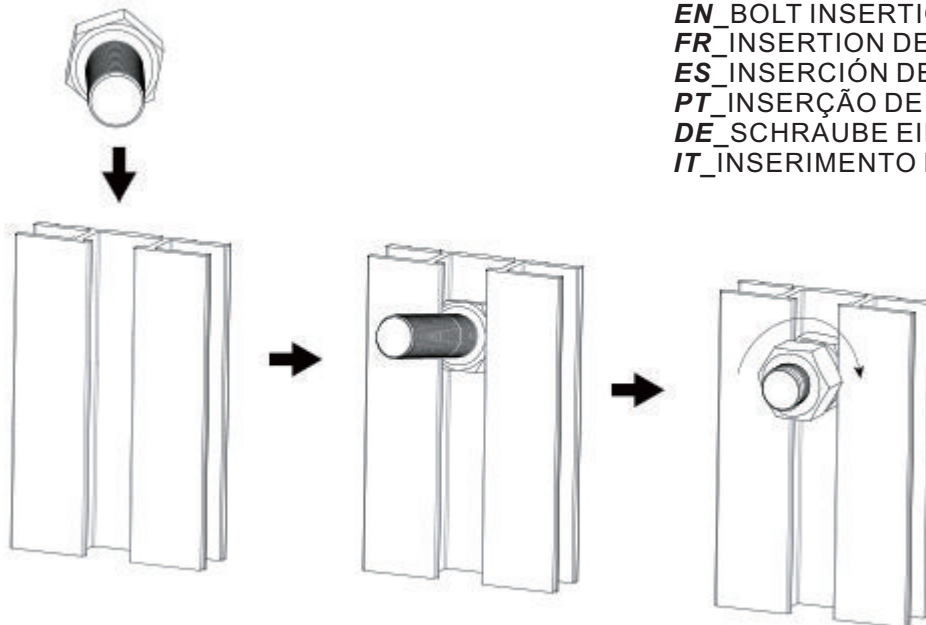

EN_BOLT INSERTION
FR_INSERTION DES BOULONS
ES_INSERCIÓN DE PERNOS
PT_INSERÇÃO DE PARAFUSOS
DE_SCHRAUBE EINSETZEN
IT_INSERIMENTO DEI BULLONI

EN Several steps in this manual involve inserting F4 Bolts into the groove of Aluminum profiles as a preparation for further installation. Dia-grams above illustrate how to use such inserted bolts.

F4 BOLTS AND NUTS

Part No. F4 refers to both the bolt and the nut. In some steps only the bolt or the nut will be used and in other steps the whole set will be used. Check the specific Part List in each step.

FR Plusieurs étapes de ce manuel impliquent l'insertion de boulons F4 dans la rainure des profilés en aluminium afin de préparer l'installation ultérieure. Les diagrammes ci-dessus illustrent l'utilisation de ces boulons insérés.

BOULONS ET ÉCROUS F4

La référence F4 désigne à la fois le boulon et l'écrou. Dans certaines étapes, seul le boulon ou l'écrou sera utilisé, alors que dans d'autres étapes, l'ensemble sera utilisé. Consultez la liste des pièces spécifiques à chaque étape.

ES Varios pasos de este manual implican la inserción de pernos F4 en la ranura de los perfiles de aluminio como preparación para su posterior instalación. Los dia-gramas anteriores ilustran cómo utilizar dichos pernos insertados.

TORNILLOS Y TUERCAS F4

La referencia F4 se refiere tanto al tornillo como a la tuerca. En algunos pasos sólo se utilizará el tornillo o la tuerca y en otros pasos se utilizará todo el conjunto. Compruebe la lista de piezas específica de cada paso.

PT Vários passos deste manual envolvem a inserção de parafusos F4 na ranhura dos perfis de alumínio como preparação para a instalação posterior. Os diagramas acima ilustram como utilizar esses parafusos inseridos.

PARAFUSOS E PORCAS F4

O número de peça F4 refere-se tanto ao parafuso como à porca. Em alguns passos, apenas o parafuso ou a porca serão utilizados e, noutros passos, será utilizado o conjunto completo. Verifique a lista de peças específica de cada passo.

DE Mehrere Schritte in diesem Handbuch beinhalten das Einsetzen von F4-Schrauben in die Nuten von Aluminiumprofilen als Vorbereitung für die weitere Montage. Die obigen Diagramme veranschaulichen die Verwendung solcher eingefügter Bolzen.

F4 SCHRAUBEN UND MUTTERN











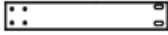











Die Teile-Nr. F4 bezieht sich sowohl auf die Schraube als auch auf die Mutter. In einigen Schritten wird nur die Schraube oder die Mutter verwendet, in anderen Schritten wird der gesamte Satz verwendet. Überprüfen Sie die spezifische Teileliste in jedem Schritt.



























IT Diverse fasi di questo manuale prevedono l'inserimento di bulloni F4 nella scanalatura dei profili di alluminio come preparazione per la successiva installazione. I diagrammi qui sopra illustrano come utilizzare i bulloni inseriti.























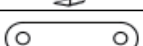

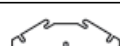





BULLONI E DADI F4

Il codice F4 si riferisce sia al bullone che al dado. In alcune fasi si utilizzerà solo il bullone o il dado, mentre in altre fasi si utilizzerà l'intero set. Controllare l'elenco dei componenti specifico di ogni fase.

PARTS LIST

Part No.	Part	Qty.
1E		2
2RE		1
2LE		1
3		4
B11		1
F3		24
Part No.	Part	Qty.
D1		1
D2		1
D3		3
D4		1
P1		2
P13		1
F1		10
Part No.	Part	Qty.
W1		1
W2		2
W3		1
W4		1
P2		1
S8		1
S9		1
F2		4
F8		1
F9		1

Part No.	Part	Qty.
4L		1
4R		1
5		1
6		1
7		2
8L		1
8R		1
9E		1
9		1
10E		1
10R		1
20-282		2
20-603		2
12-1		1
12		5
13		1
15L		1
15R		1
16		2
17L		1
17R		1
18		1
19		3
20		3
22		10
25L		1
25R		1

Part No.	Part	Qty.
P3L		1
P3R		1
P4L		1
P4R		1
P5		1
P6		1
P7E		1
P8		4
P8-1		4
P9E		3
P10		1
B2		5
B3		2
B4		2
B5		2
B7		1
B8		1
B9		1
B10		1
B15		10
B15-1		2
B16		2
B22		4
S6L		1
S6R		1
S5		2
S7		2
F6		2
F4		126
F5		24

Assembling of Pre-fabricated Base

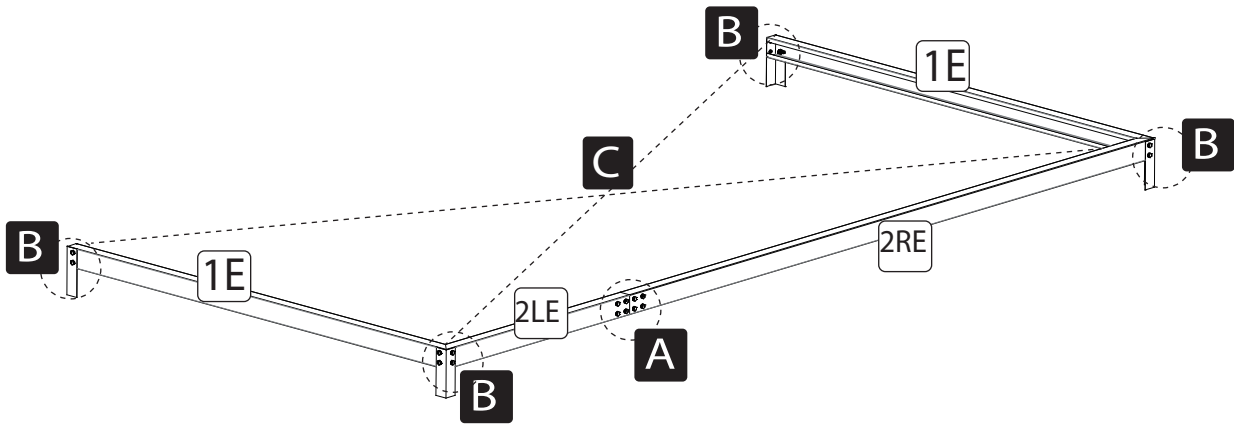

OUTSIDE VIEW

Part No.	Part	Qty.
1E		2
2RE		1
2LE		1
3		4
B11		1
F3		24

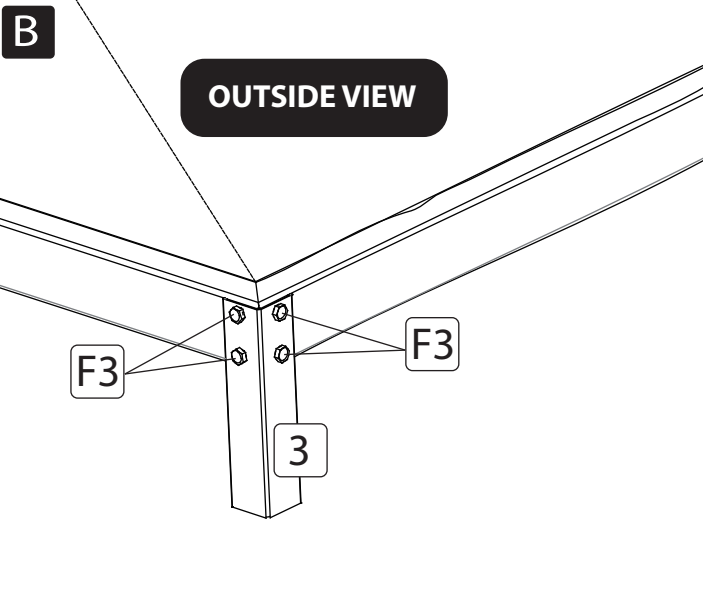
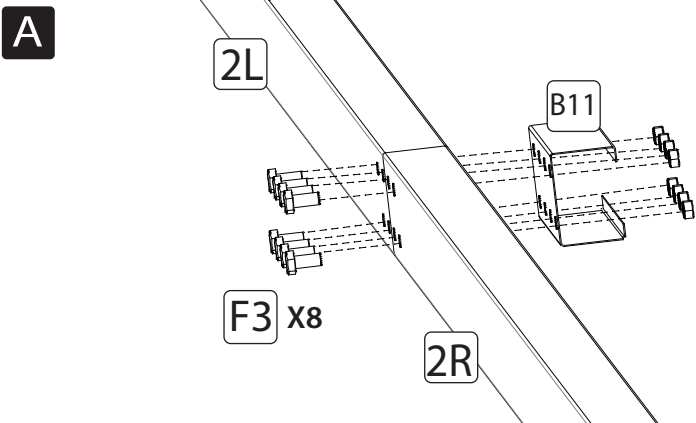

OUTSIDE VIEW



EN_ Take the fully assembled base to the chosen site and secure the base to the ground.

TIP: measure the length of the two diagonal of the base to make sure that the base is in a square shape.

Use a level to make sure the secured base is at.

FR_ Apportez la base entièrement assemblée sur le site choisi et fixez-la au sol.

CONSEIL : mesurez la longueur des deux diagonales de la base pour vous assurer qu'elle est bien carrée.

Utilisez un niveau pour vous assurer que la base fixée est à l'équerre.

ES_ Lleva la base completamente montada al lugar elegido y fijala al suelo.

CONSEJO: mide la longitud de las dos diagonales de la base para asegurarte de que la base tiene forma cuadrada.

Utilice un nivel para asegurarse de que la base fijada está a.

PT_ Leve a base completamente montada para o local escolhido e fixe-a ao solo.

SUGESTÃO: meça o comprimento das duas diagonais da base para se certificar de que a base tem uma forma quadrada.

Utilize um nível para se certificar de que a base fixada está no ponto.

DE_ Bringen Sie den fertig montierten Sockel an den gewählten Standort und befestigen Sie ihn auf dem Boden.

TIPP: Messen Sie die Länge der beiden Diagonalen des Sockels, um sicherzustellen, dass der Sockel eine quadratische Form hat.

Verwenden Sie eine Wasserwaage, um sicherzustellen, dass der befestigte Sockel waagrecht steht.

IT_ Portare la base completamente assemblata nel luogo prescelto e fissarla al terreno.

CONSIGLIO: misurate la lunghezza delle due diagonali della base per assicurarvi che la base sia di forma quadrata.

Utilizzare una livella per assicurarsi che la base fissata sia a livello.

EN Two foundation options with pre-fabricated Base
FR Deux options de fondation avec base préfabriquée
ES Dos opciones de cimentación con base prefabricada
PT Duas opções de fundação com base pré-fabricada
DE Zwei Fundamentoptionen mit vorgefertigtem Sockel
IT Due opzioni di fondazione con base prefabbricata

EN Option 1: Corner Stakes mounted into the soil
FR Option 1: Piquets d'angle montés dans le sol
ES Opción 1: Estacas de esquina instaladas en el suelo
PT Opção 1: Estacas de canto montadas no solo
DE Möglichkeit 1: In den Boden eingelassene Eckpfähle
IT Opzione 1: Paletti angolari montati nel terreno

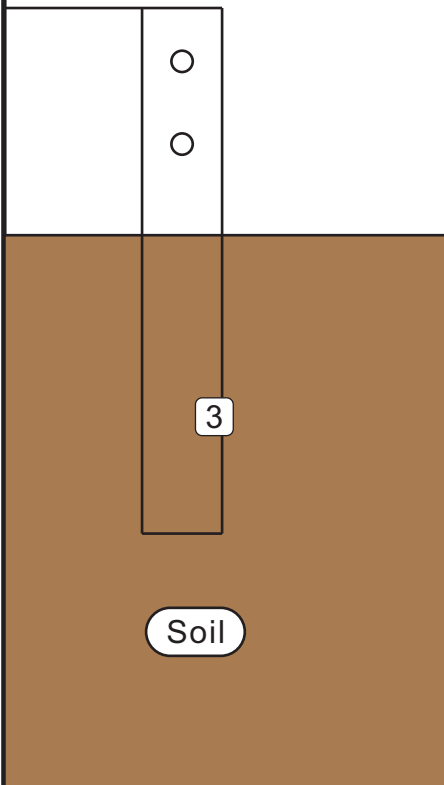

EN Easy and quick to install. Suitable to use in areas with less extreme weather
FR Facile et rapide à installer. Convient aux régions où les conditions météorologiques sont moins extrêmes.
ES Fácil y rápido de instalar. Adecuado para su uso en zonas con climas menos extremos
PT Fácil e rápido de instalar. Adequado para utilização em zonas com condições climatéricas menos extremas
DE Einfach und schnell zu installieren. Geeignet für den Einsatz in Gebieten mit weniger extremen Wetterbedingungen
IT Facile e veloce da installare. Adatto all'uso in aree con clima meno estremo

EN Option 2: Corner Stakes mounted into concrete
FR Option 2: Piquets d'angle montés dans le béton
ES Opción 2: Estacas de esquina montadas en hormigón
PT Opção 2: Estacas de canto montadas em betão
DE Möglichkeit 2: In Beton montierte Eckpfähle
IT Opzione 2: Paletti d'angolo montati nel calcestruzzo

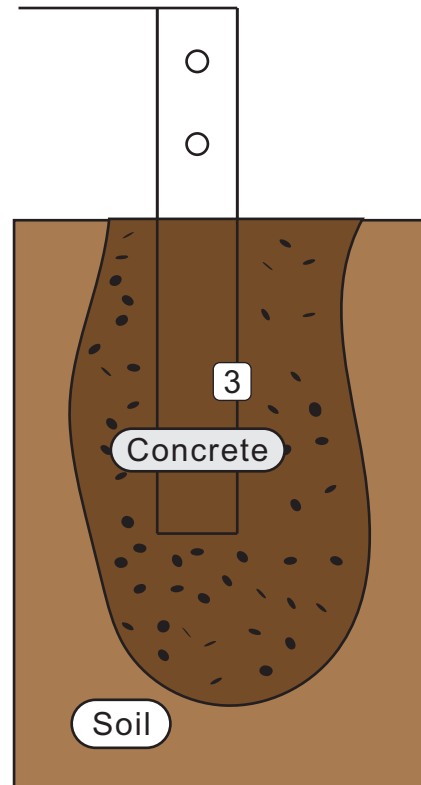

EN Best option if you want your greenhouse fully secured.
FR La meilleure option si vous souhaitez que votre serre soit entièrement sécurisée.
ES La mejor opción si desea que su invernadero esté totalmente protegido.
PT A melhor opção se quiser que a sua estufa fique totalmente protegida.
DE Die beste Option, wenn Sie Ihr Gewächshaus vollständig sichern wollen.
IT L'opzione migliore se volete che la vostra serra sia completamente protetta.

Assembling of Door

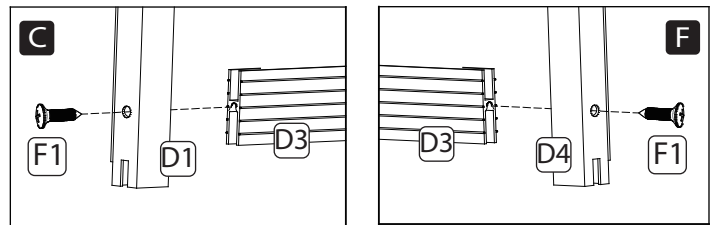
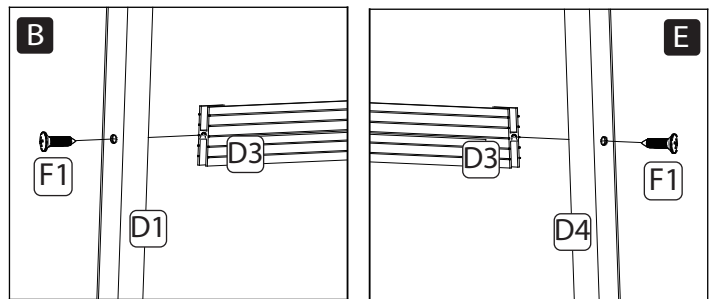
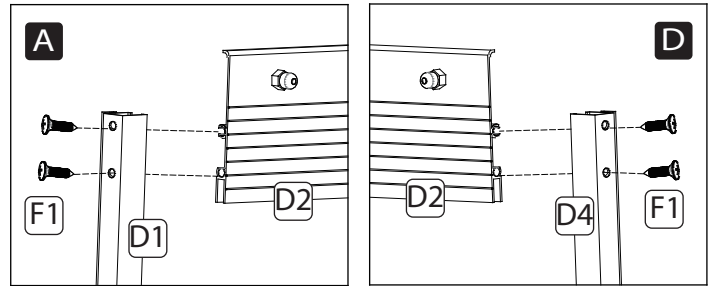
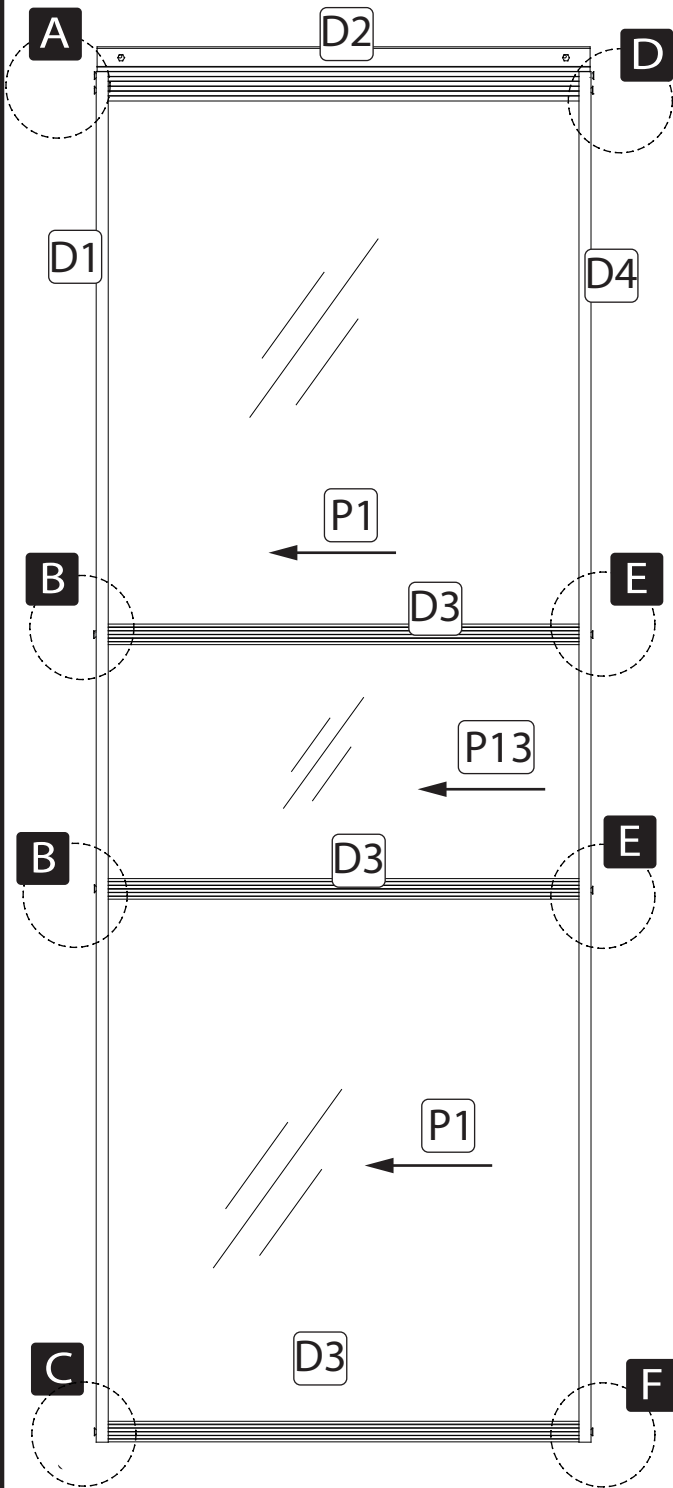



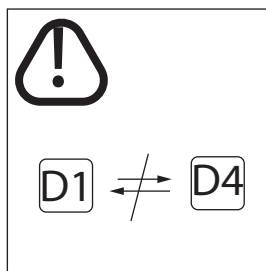
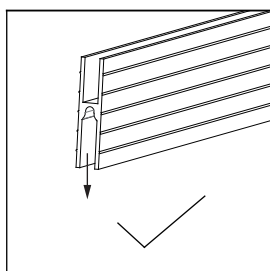
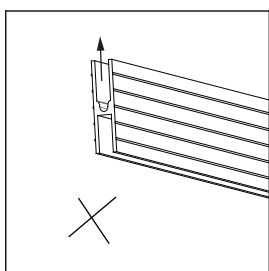



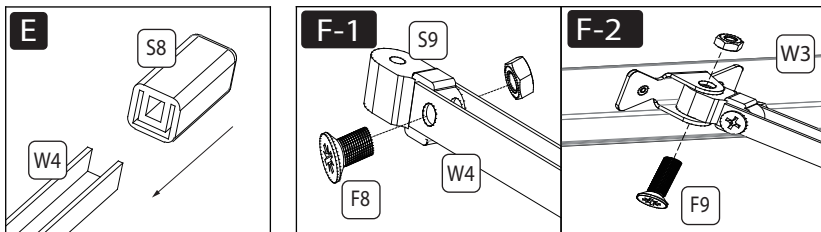
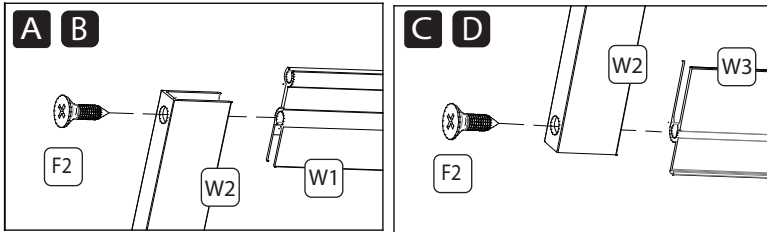
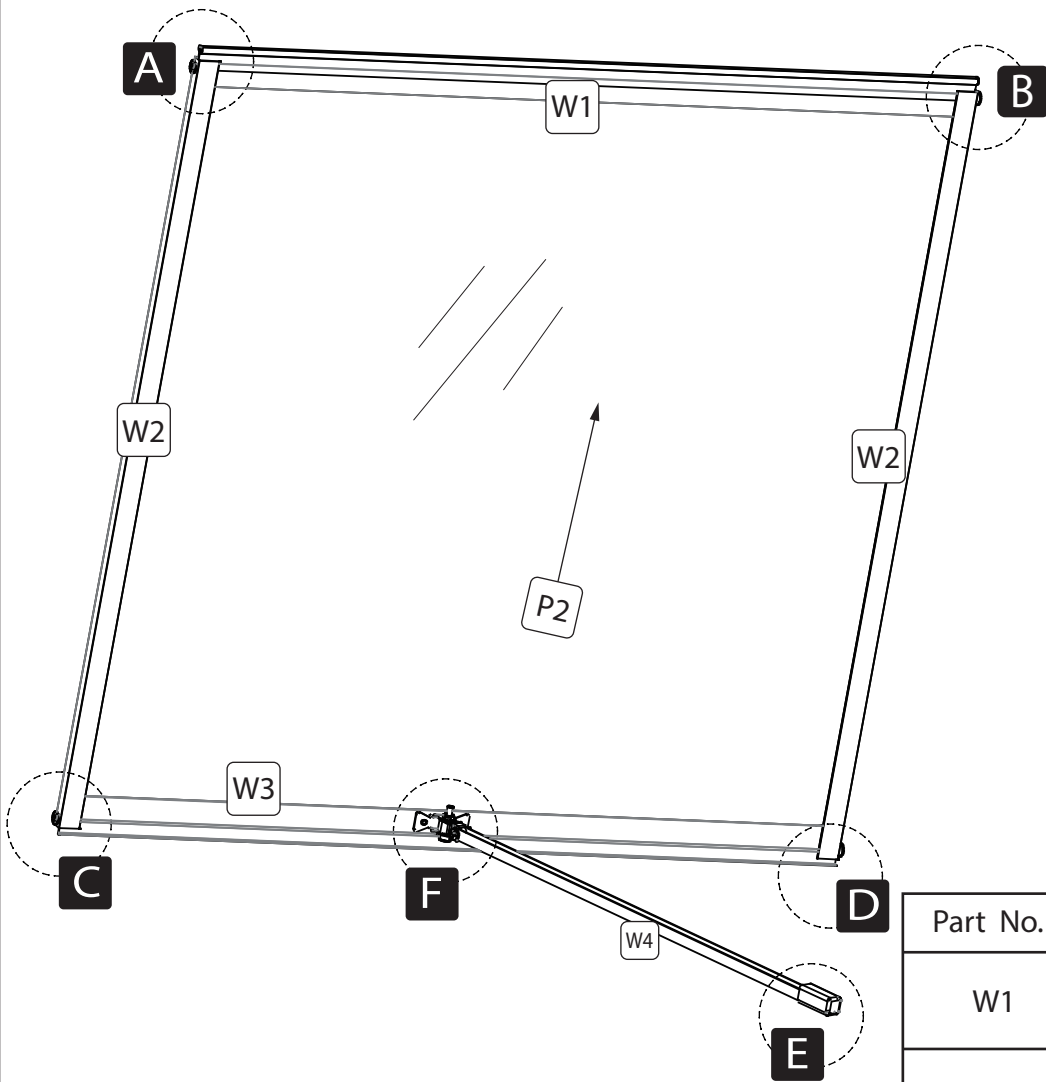

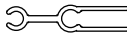
Part No.	Part	Qty.
D1		1
D2		1
D3		3
D4		1
F1		10
P1		2
P13		1

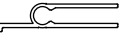

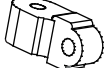
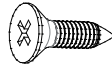
Assembling of window



Part No.	Part	Qty.
W1		1
W2		2
W3		1
W4		1
S8		1
S9		1
F2		4
F8		1
F9		1
P2		1

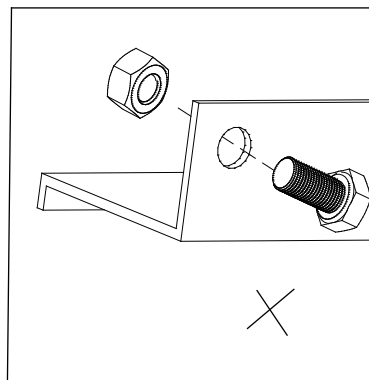
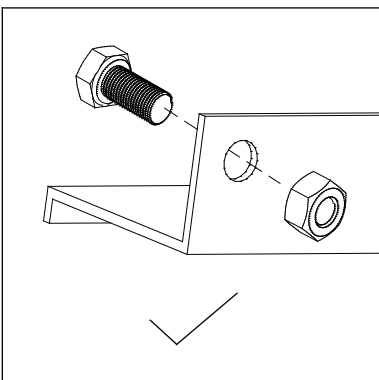
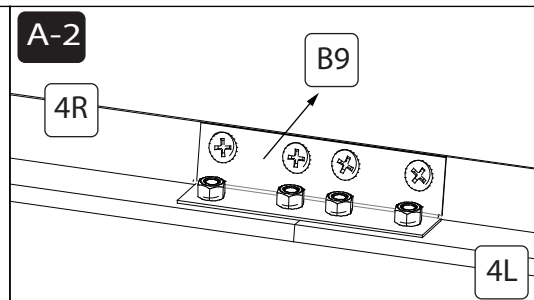
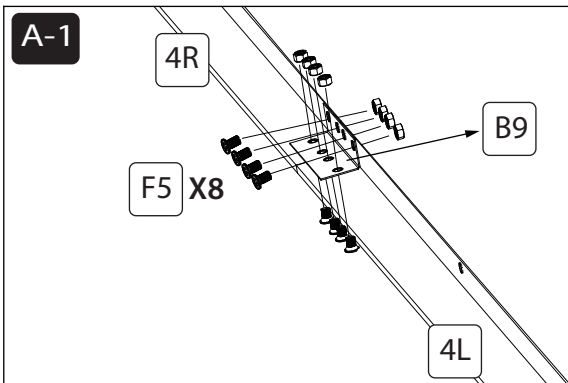
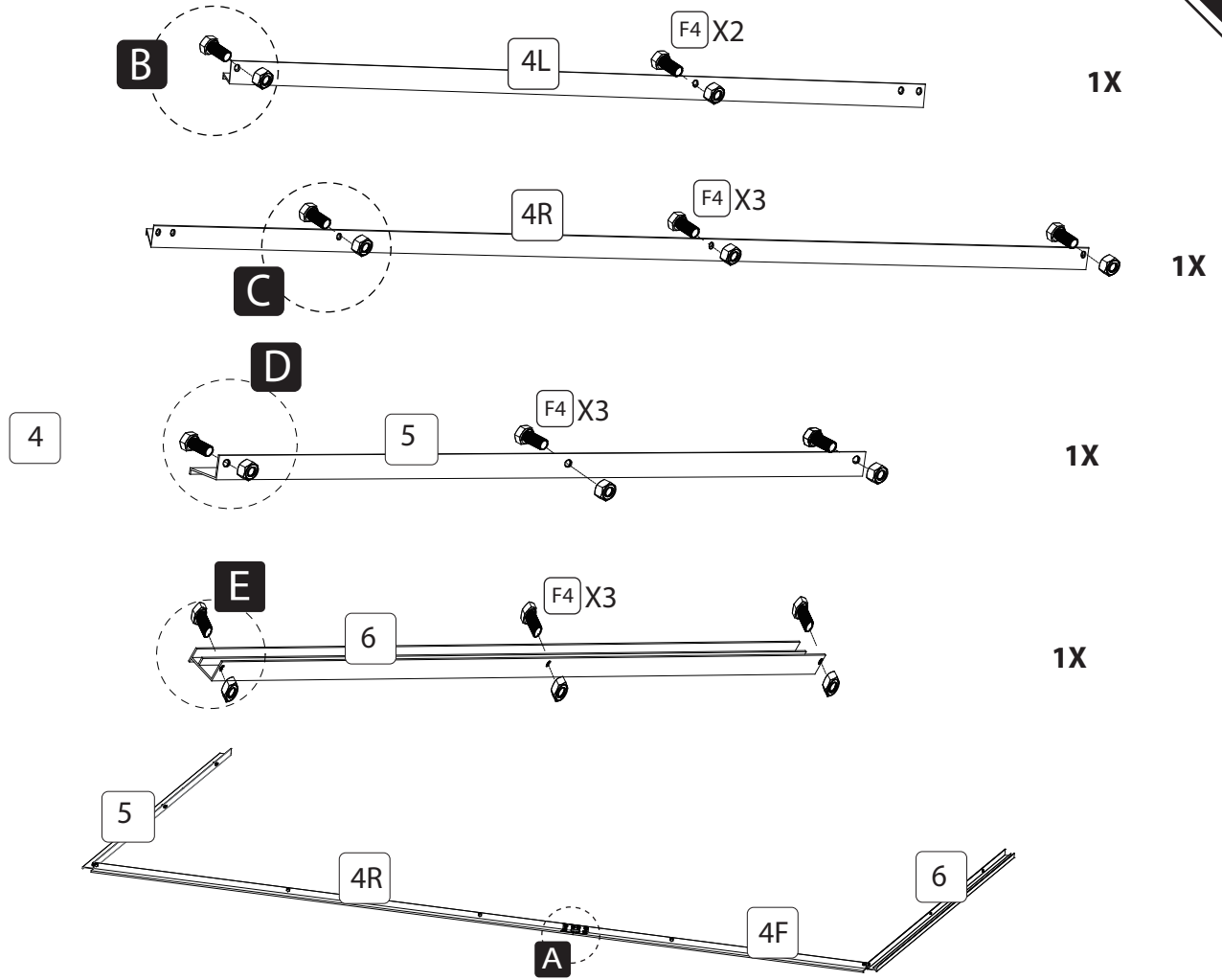

Part No.	Part	Qty.
4R		1
4L		1
5		1
6		1
B9		1
F4		11
F5		8

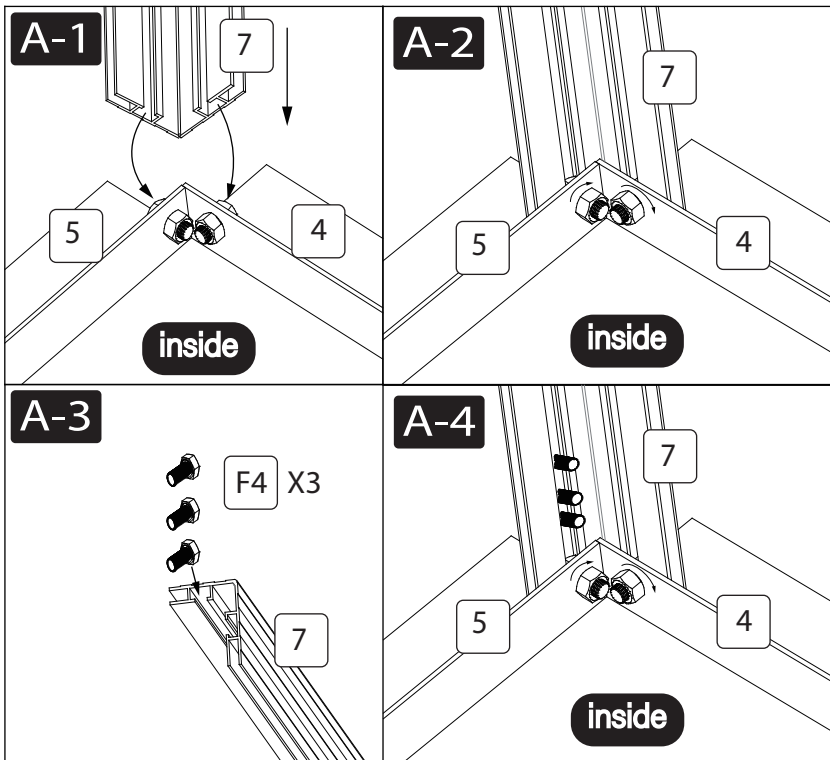
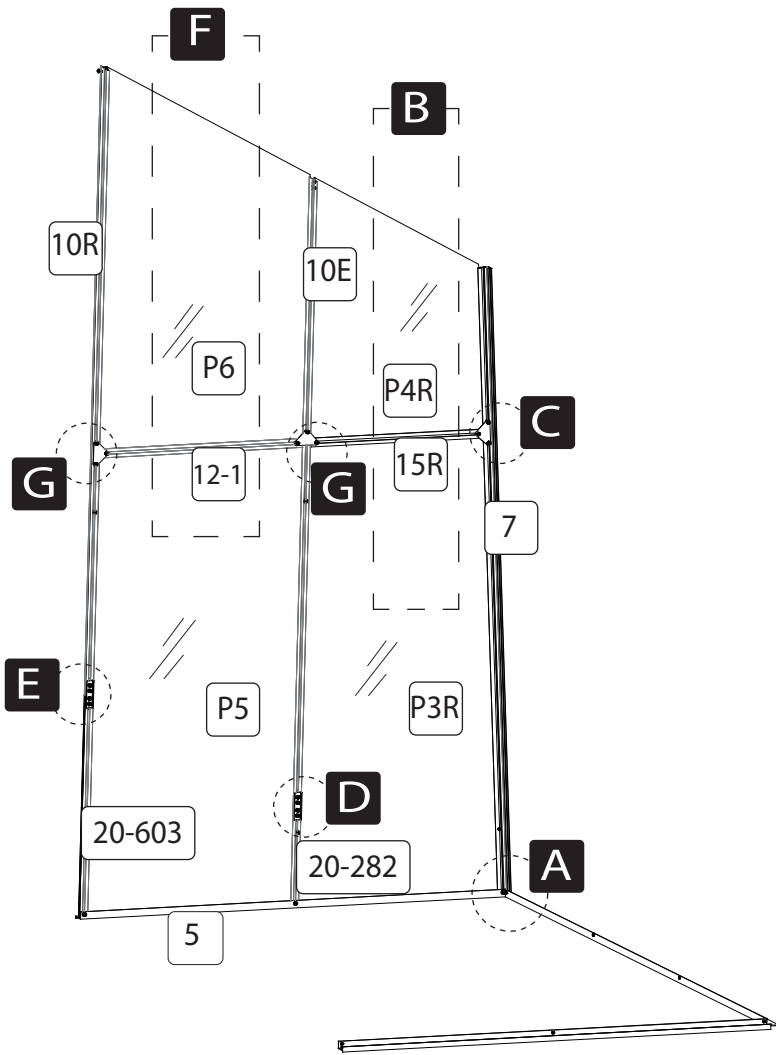

Part No.	Part	Qty.
7		1
10E		1
20-282		1
10R		1
20-603		1
15R		1
12-1		1
P4R		1
P3R		1
P6		1
P5		1
F4		21
B22		2
B15		3

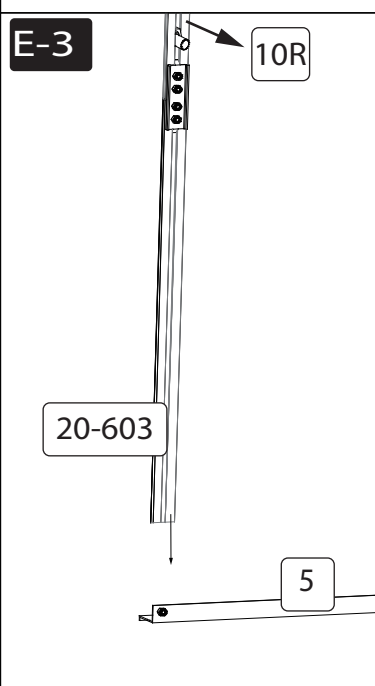
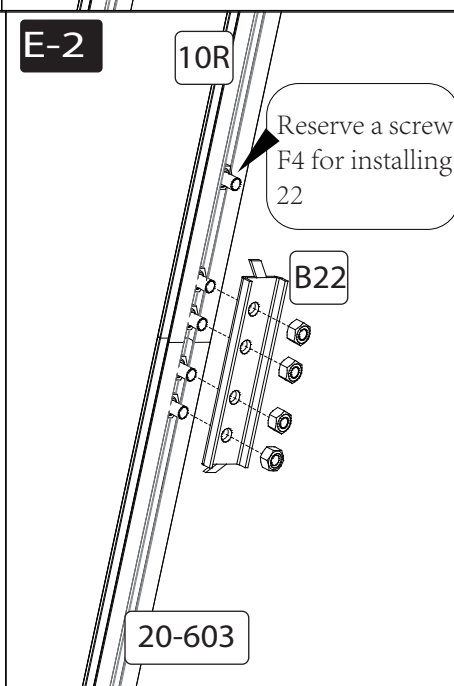
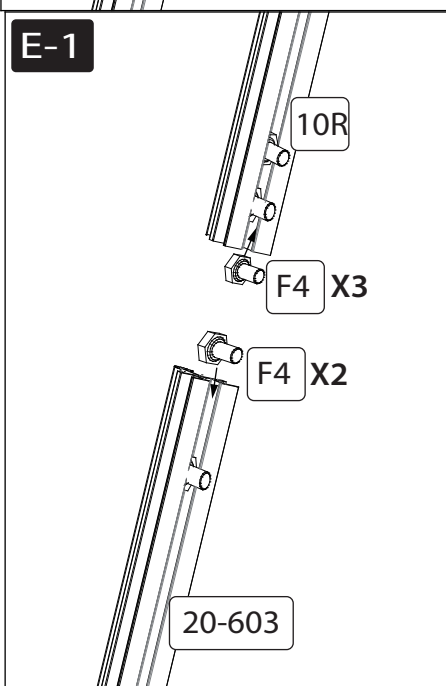
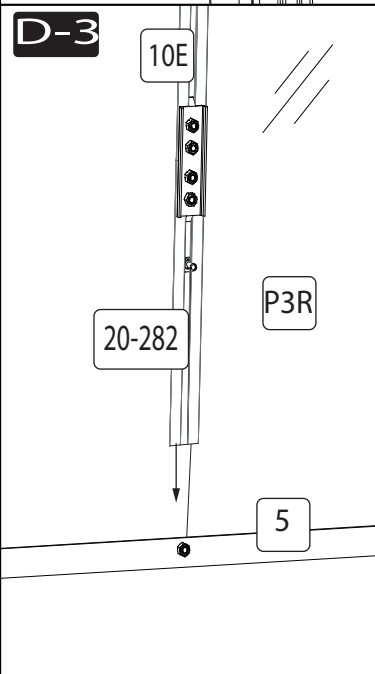
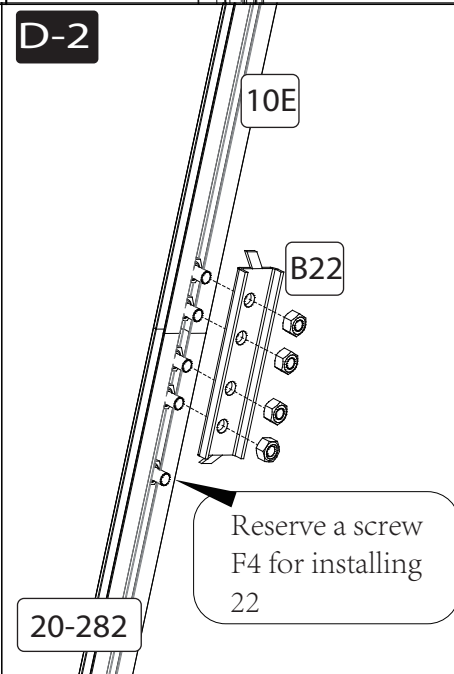
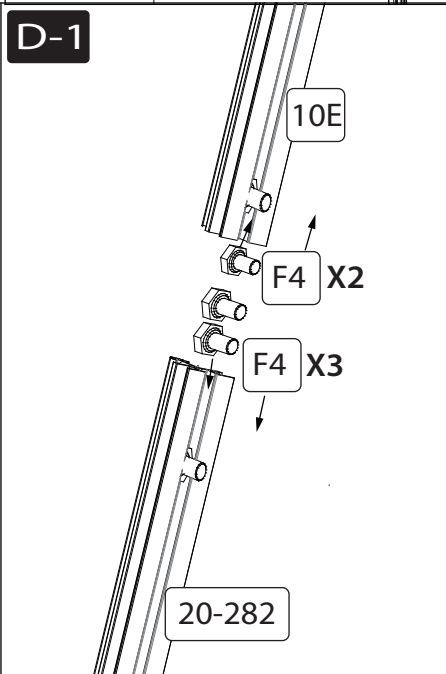
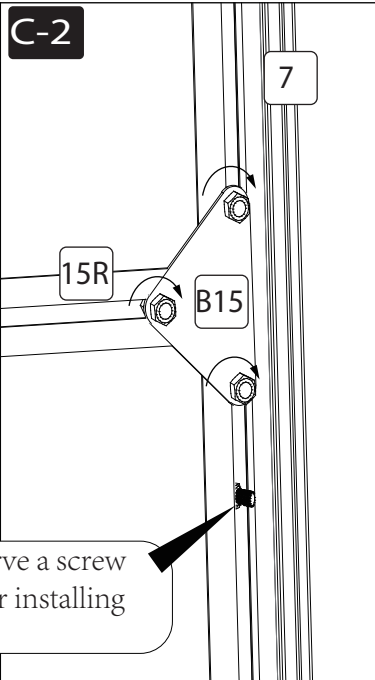
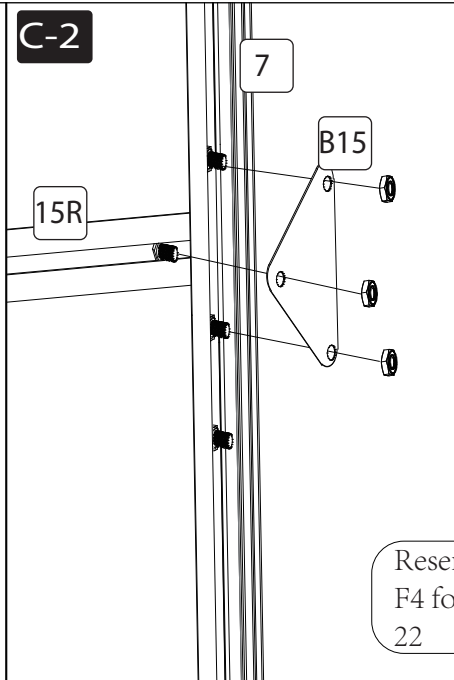
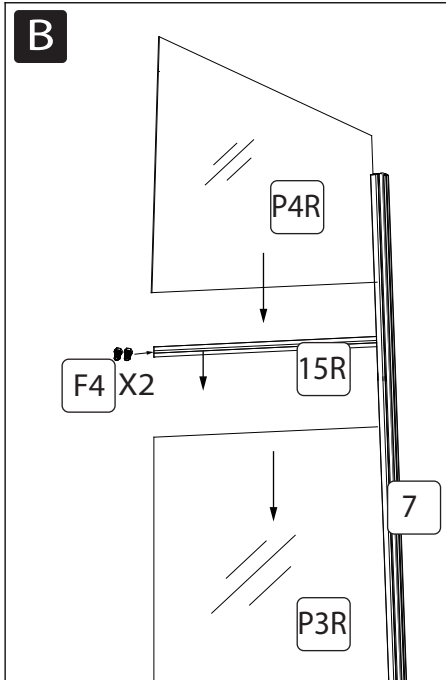

inside

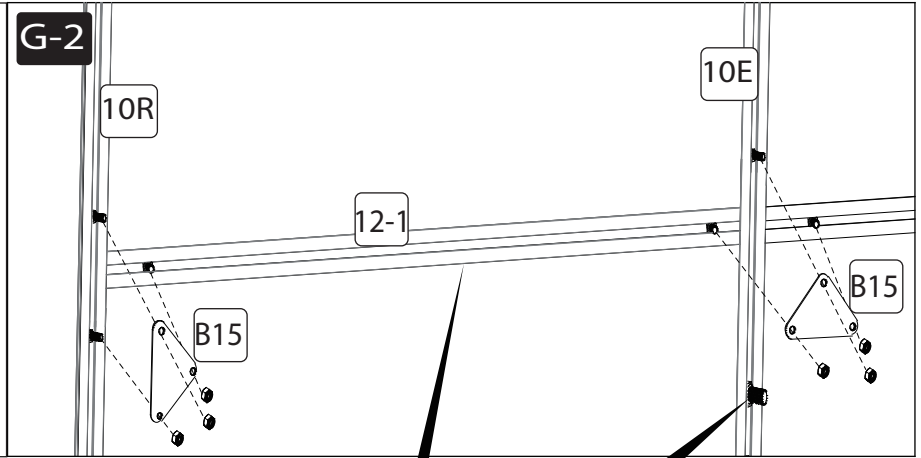
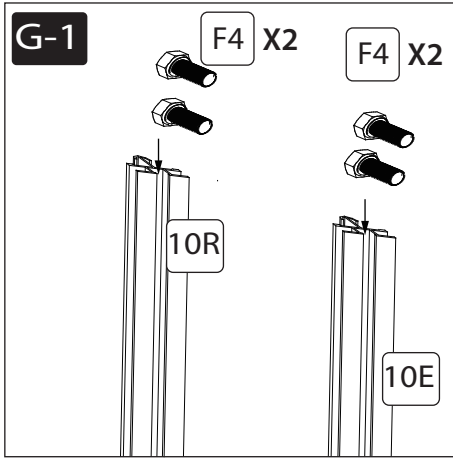
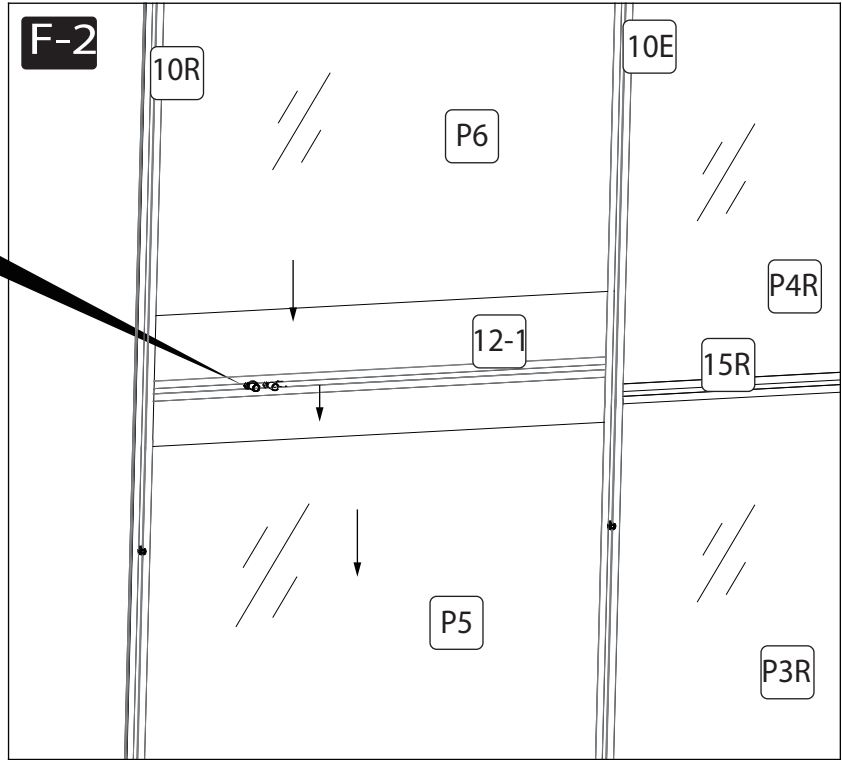
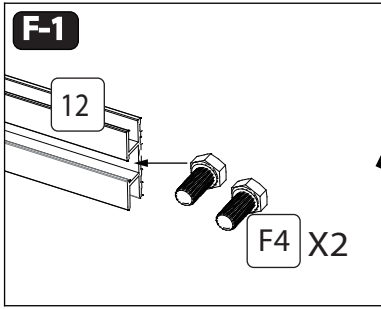

Reserve a screw
F4 for installing
22

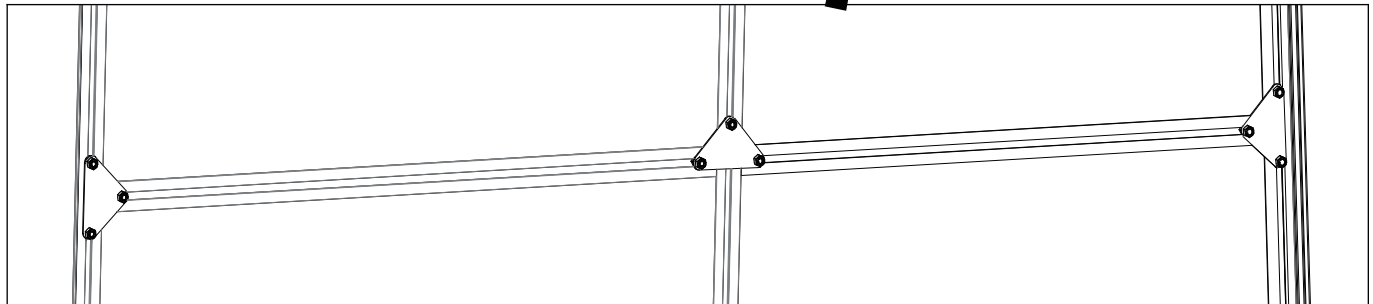

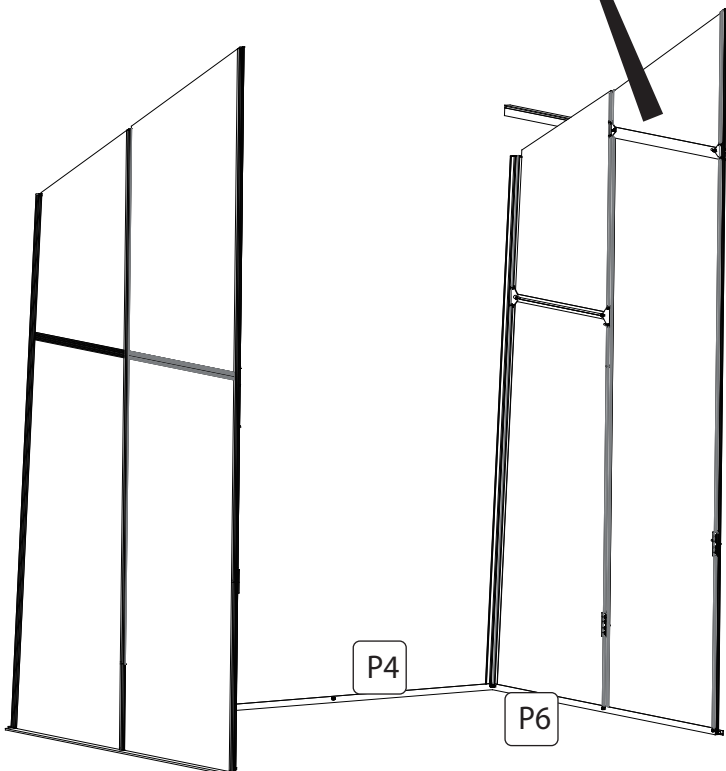
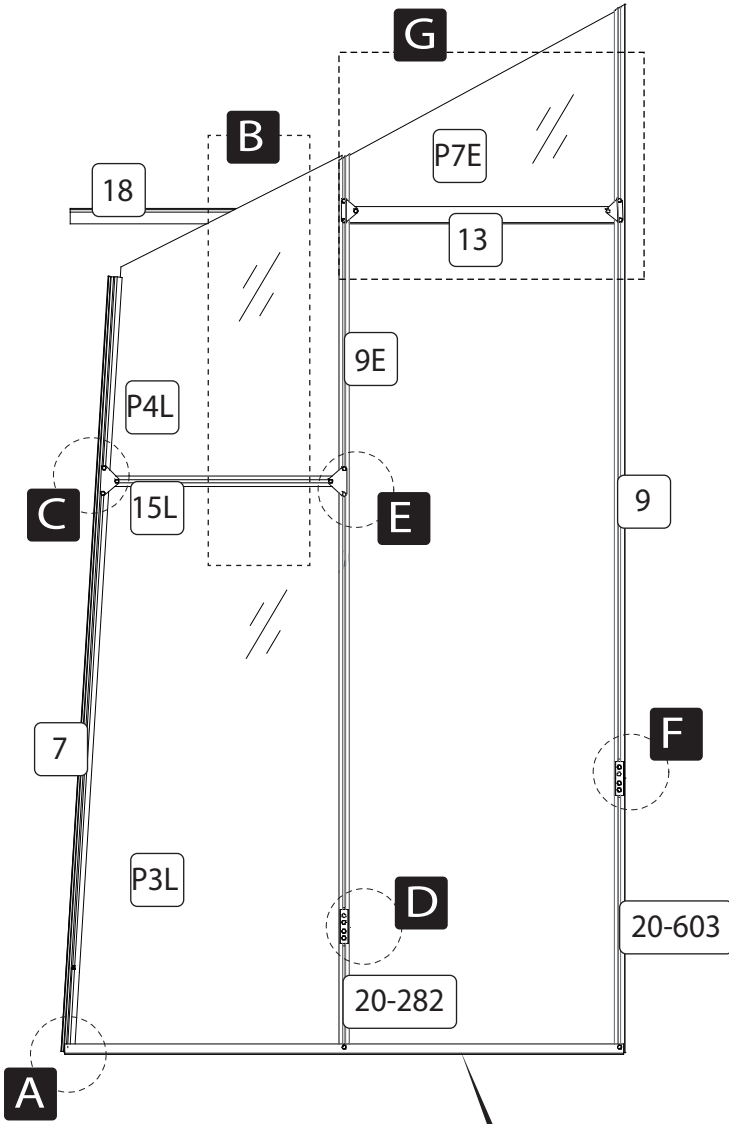

Part No.	Part	Qty.
7		1
9E		1
20-282		1
9		1
20-603		1
15L		1
13		1
18		1
P4L		1
P3L		1
P7E		1
B22		2
B15-1		2
B15		2
F4		20
F6		2

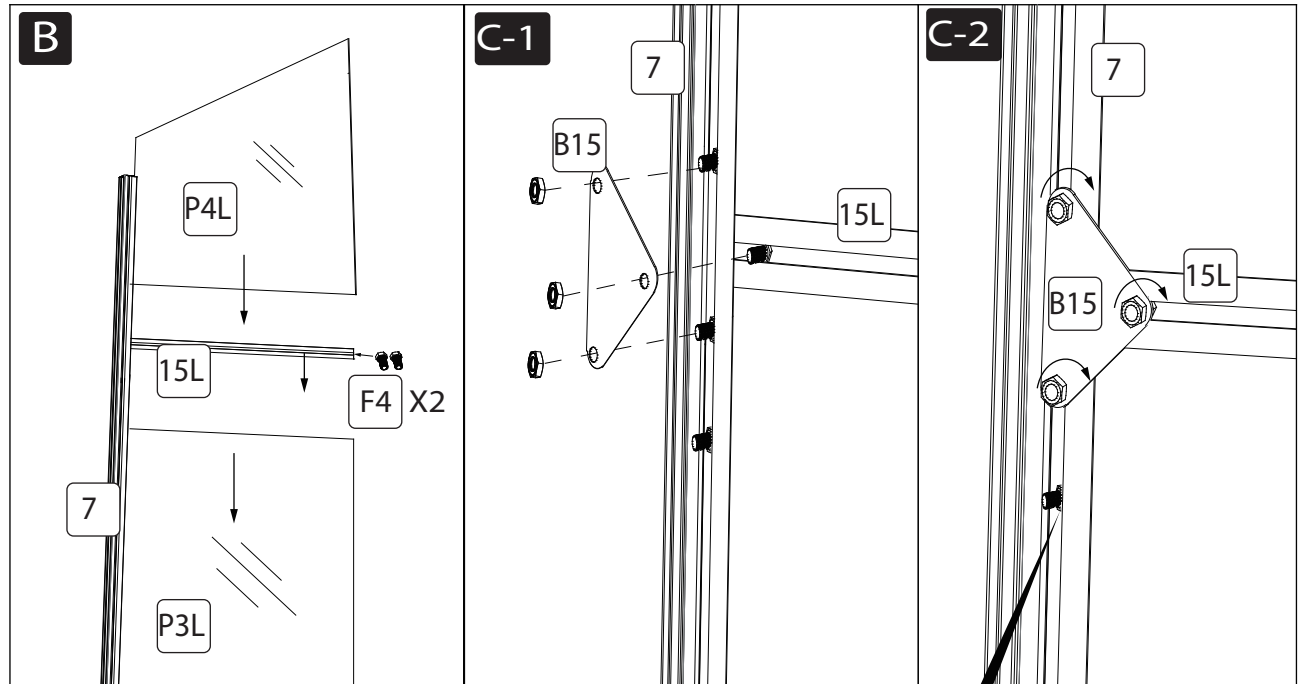
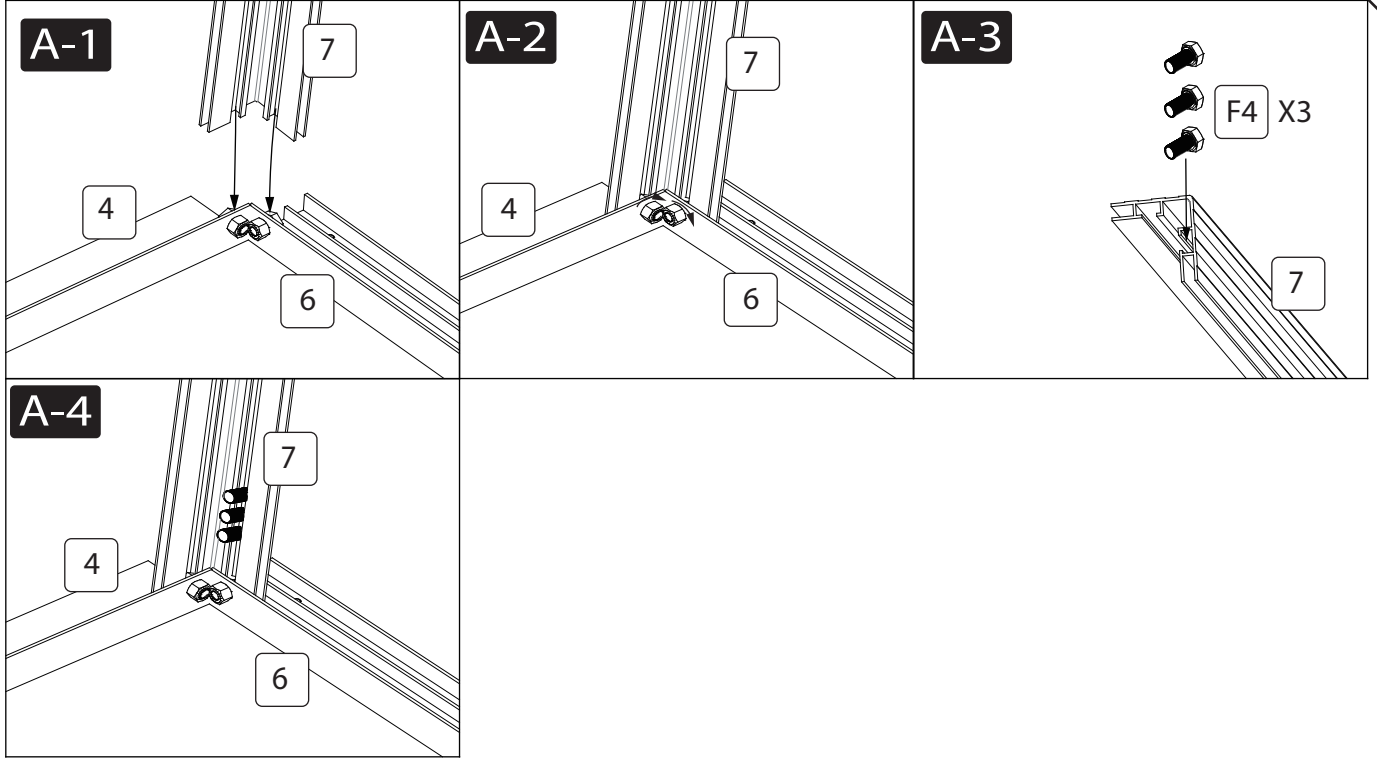

Reserve a screw
F4 for installing
22

inside

Reserve a screw
F4 for installing
22

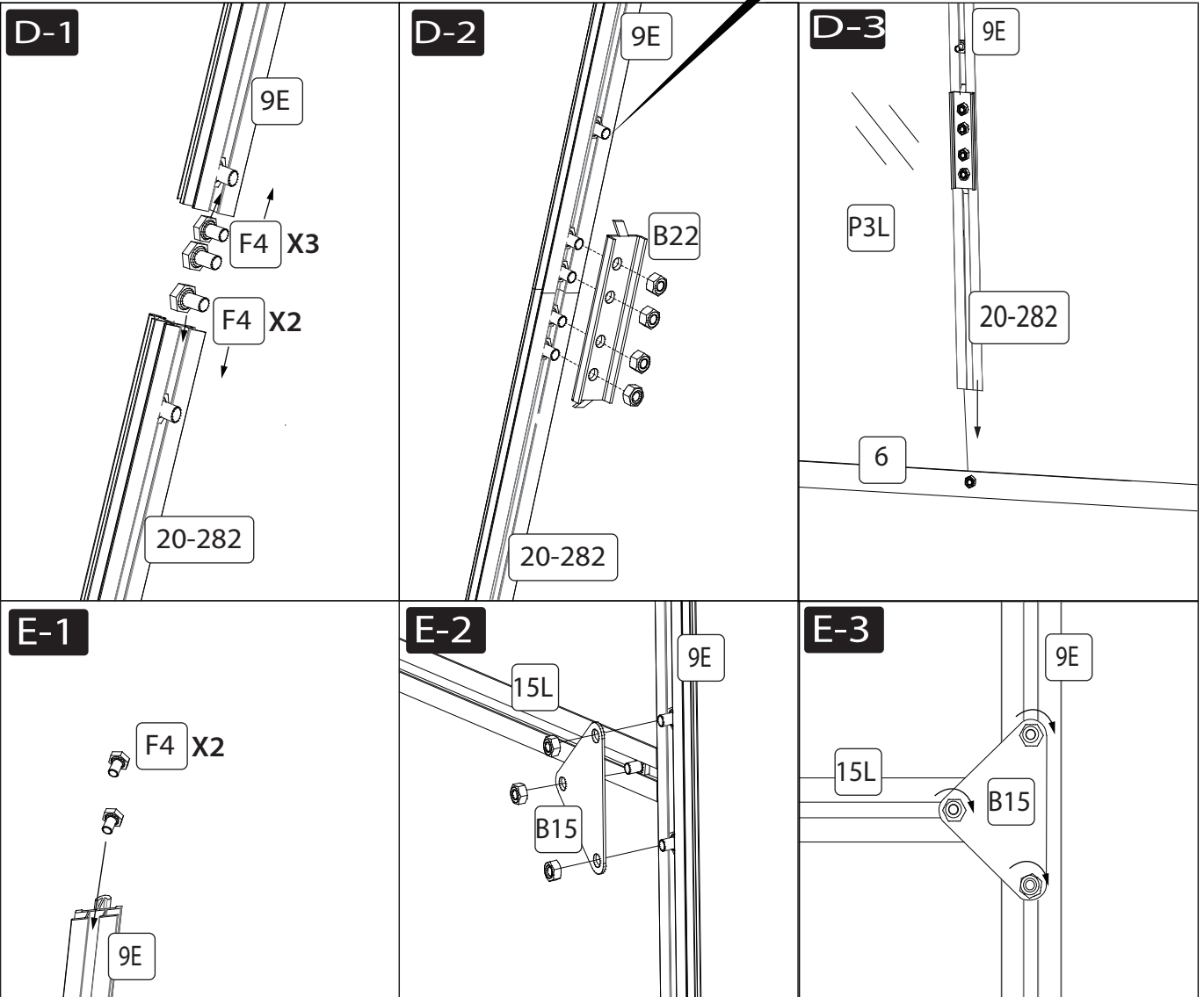

inside

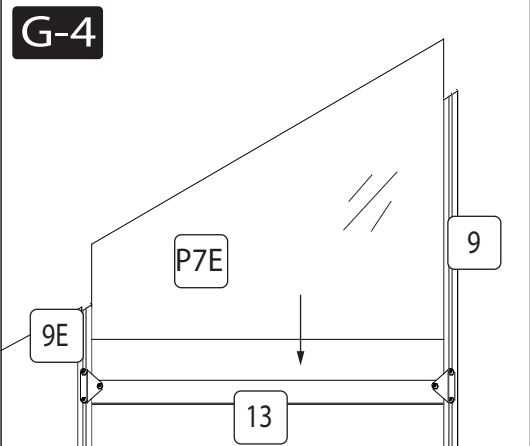
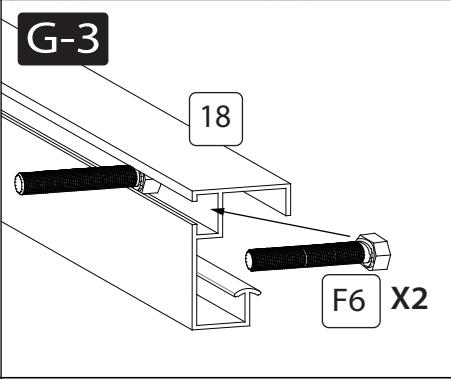
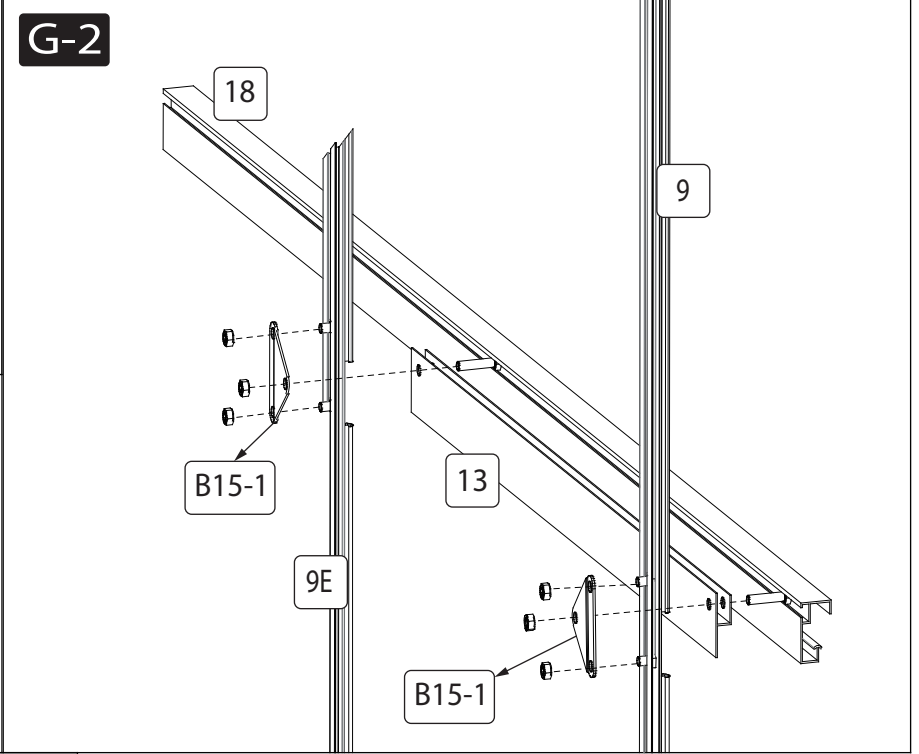
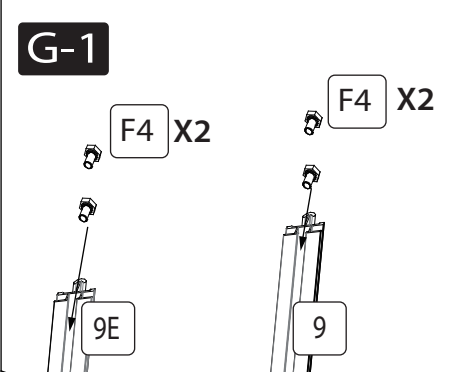
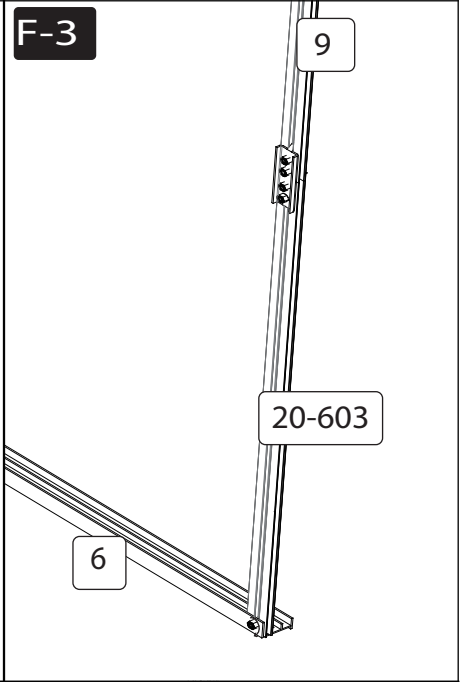
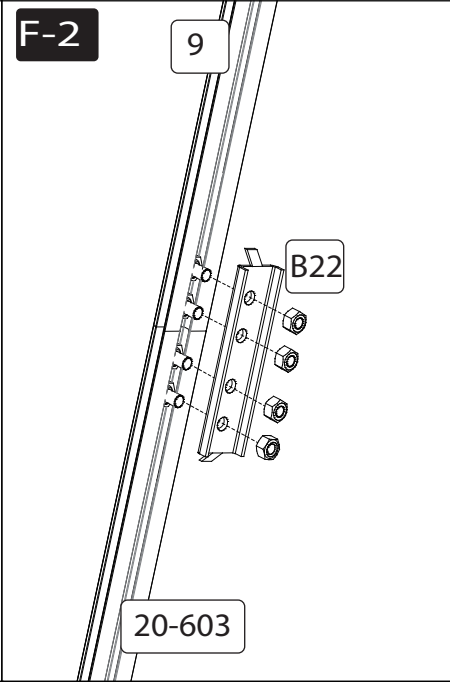
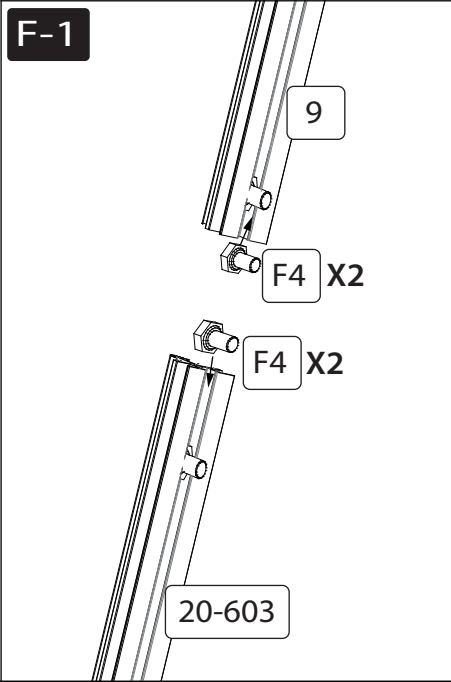

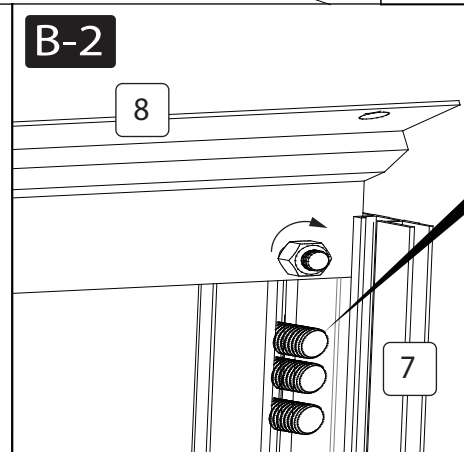
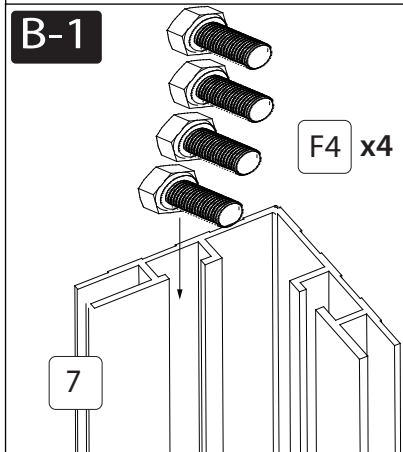
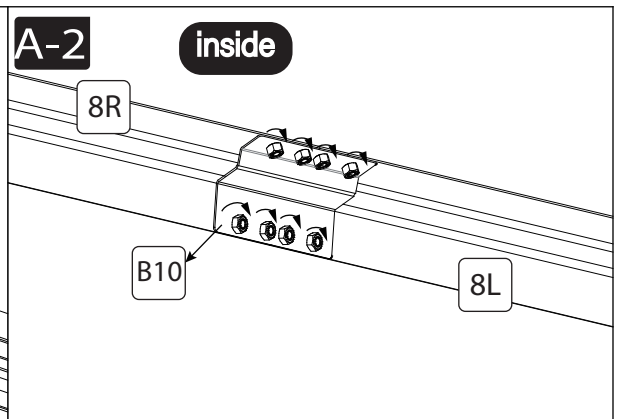
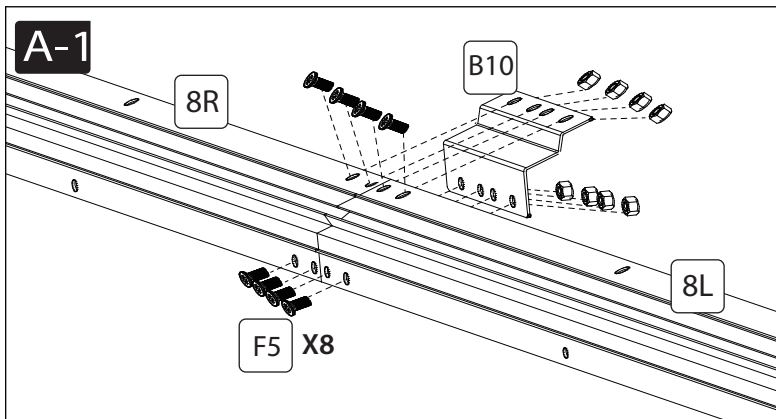
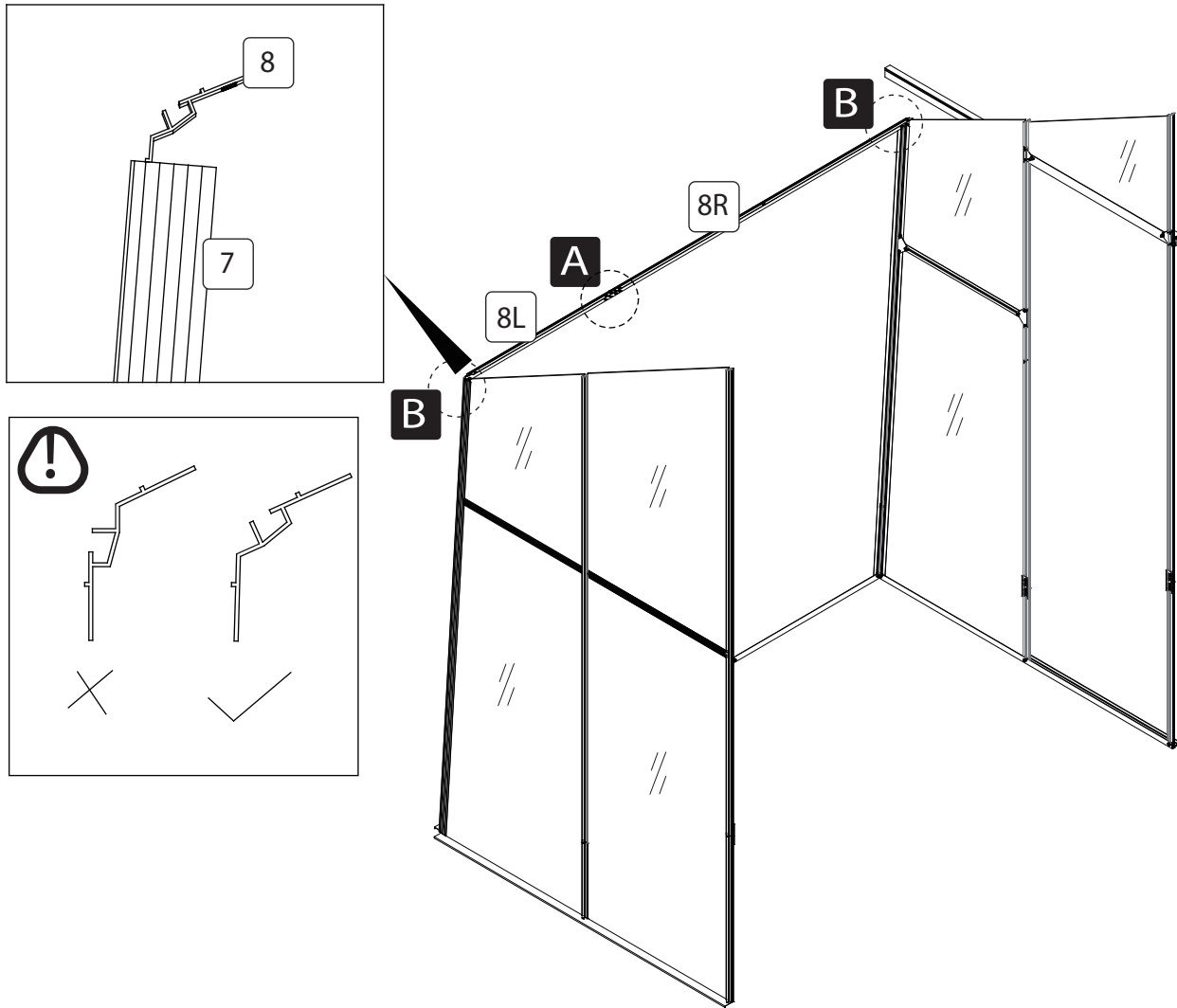





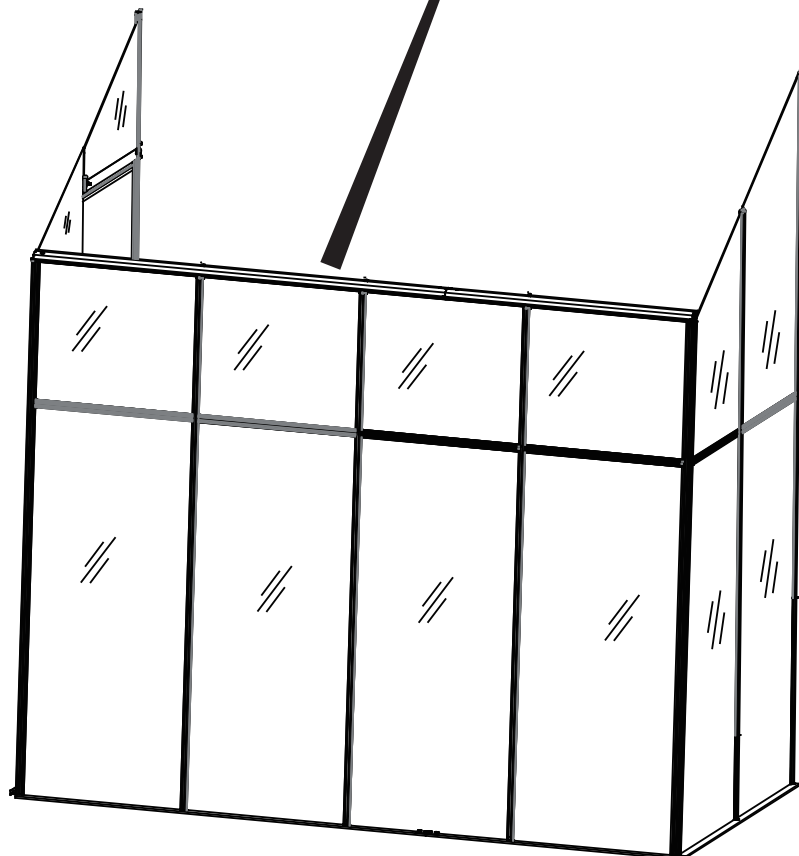
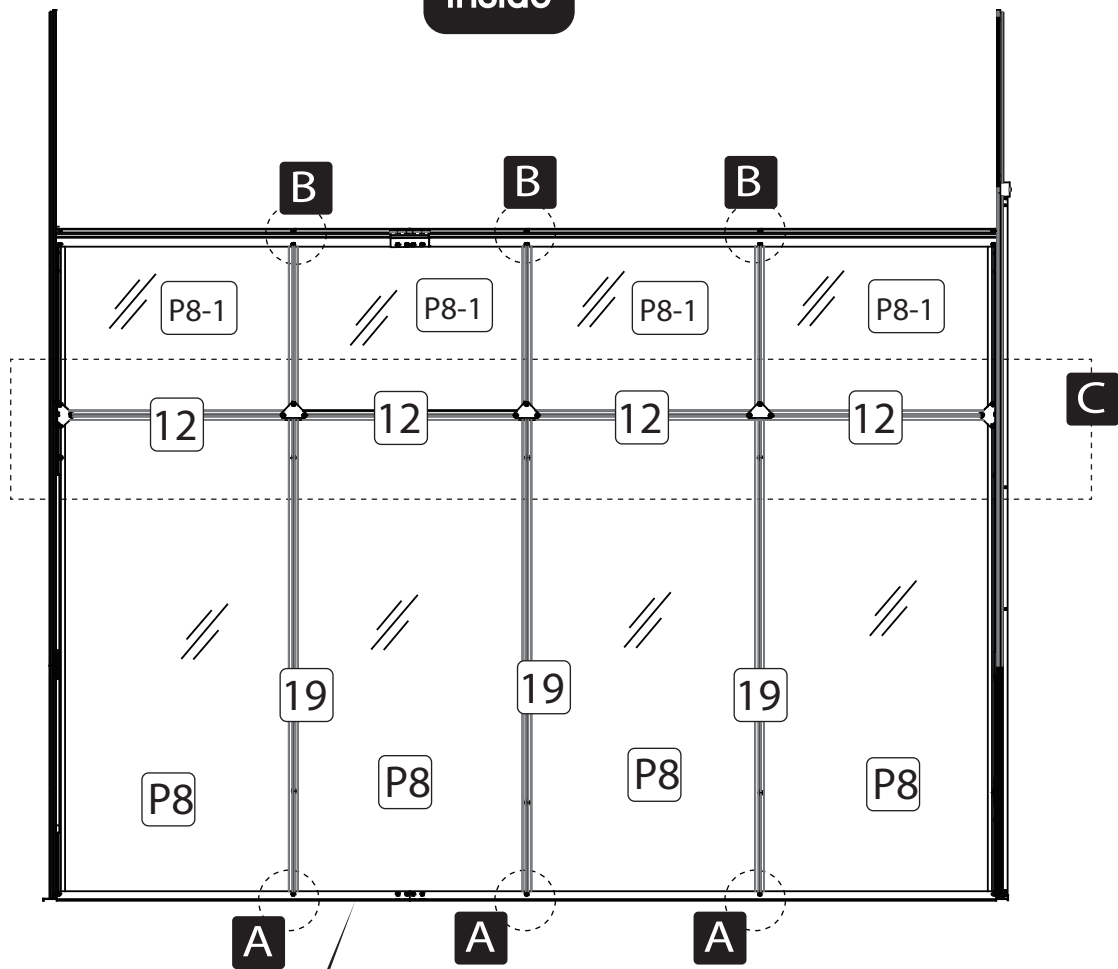

Part No.	Part	Qty.
8R		1
8L		1
B10		1
F4		8
F5		8

inside





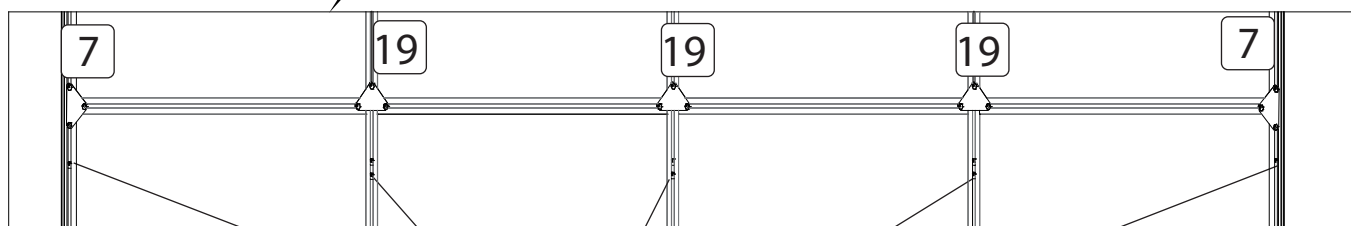
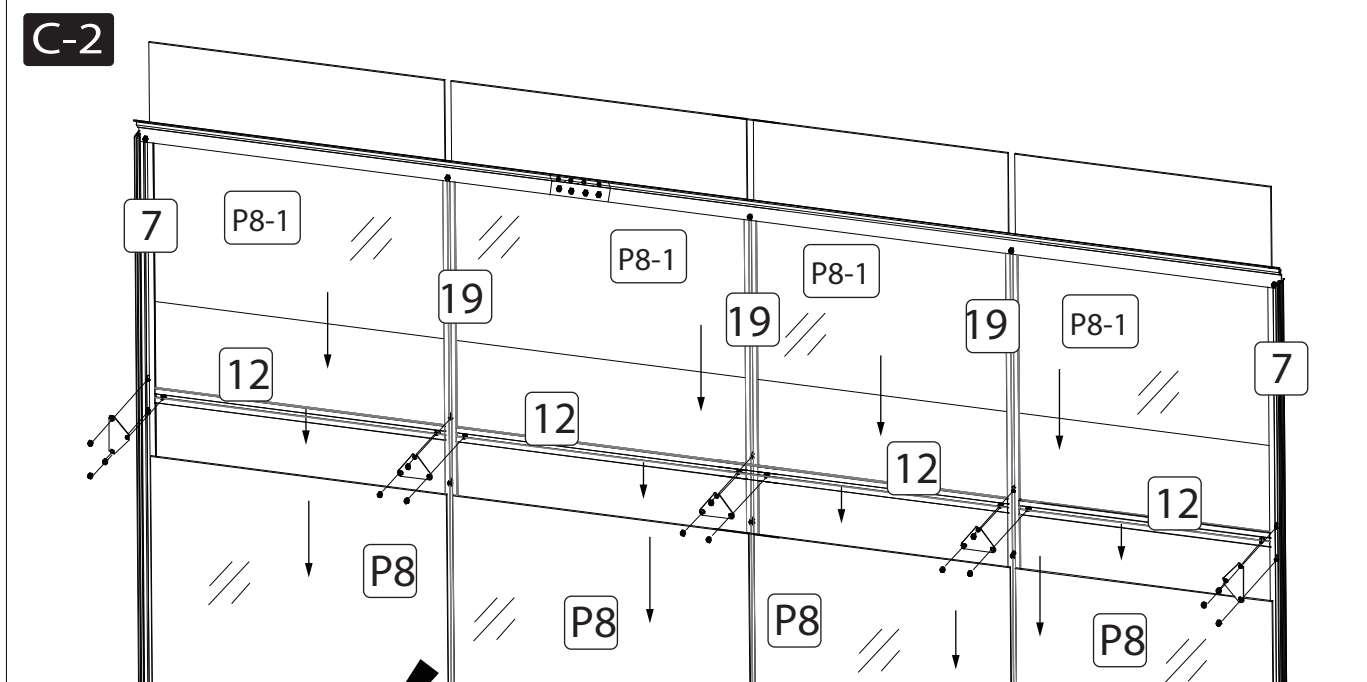
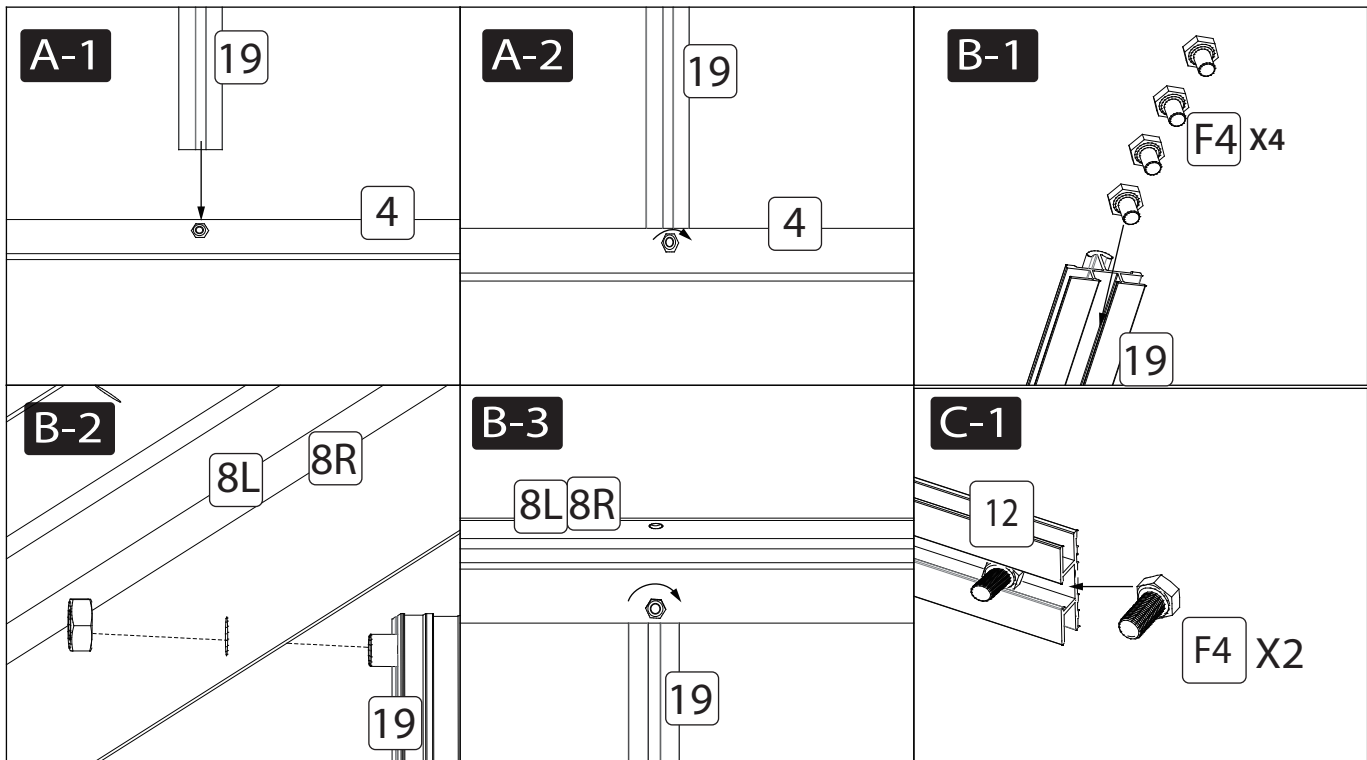

Part No.	Part	Qty.
19		3
12		4
P8		4
P8-1		4
B15		5
F4		20

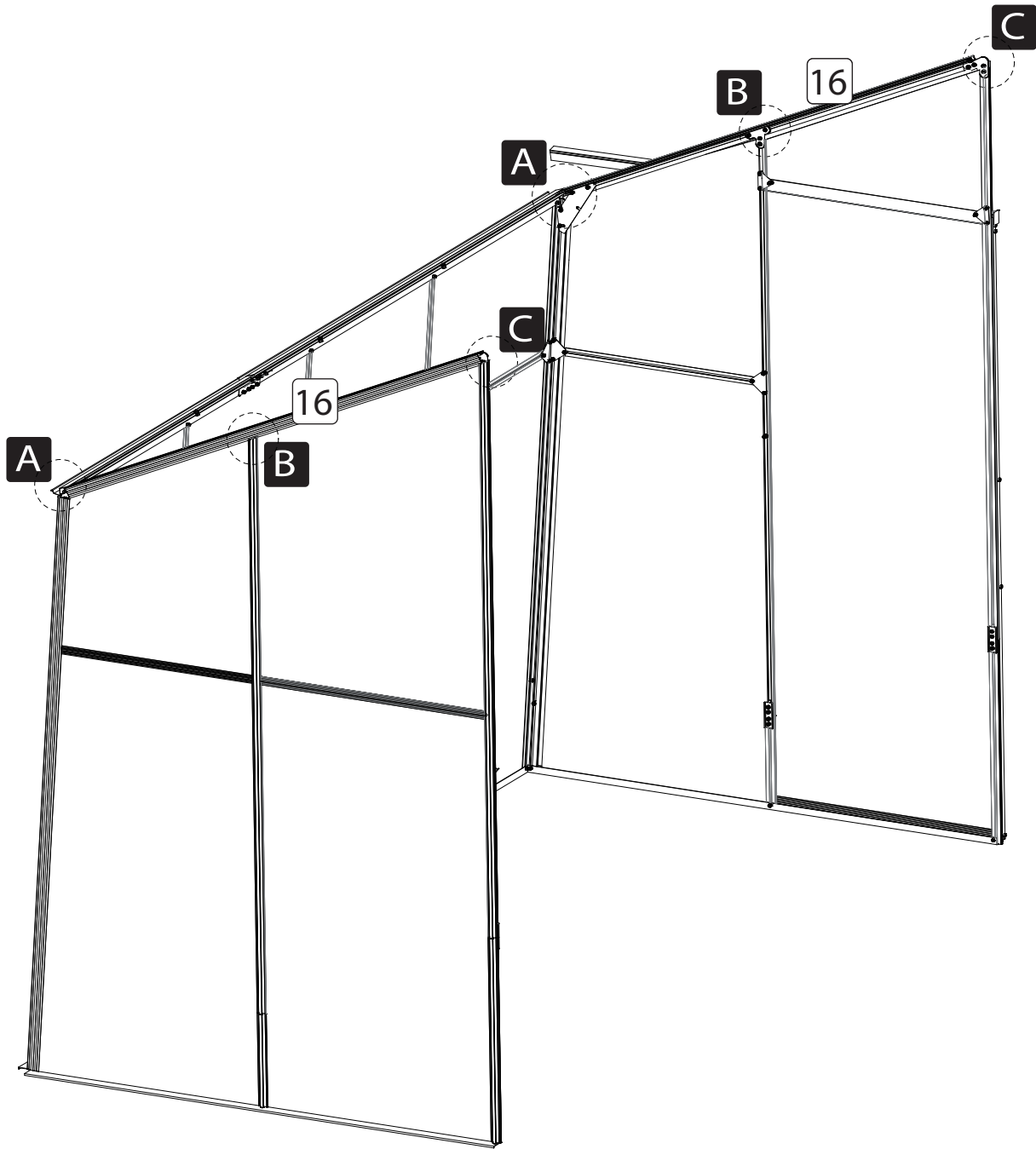

Profile No. 7 reserves 1 pieces of F4 for 22
 Profile No. 19 reserves 2 pieces of F4 for 22

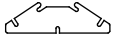



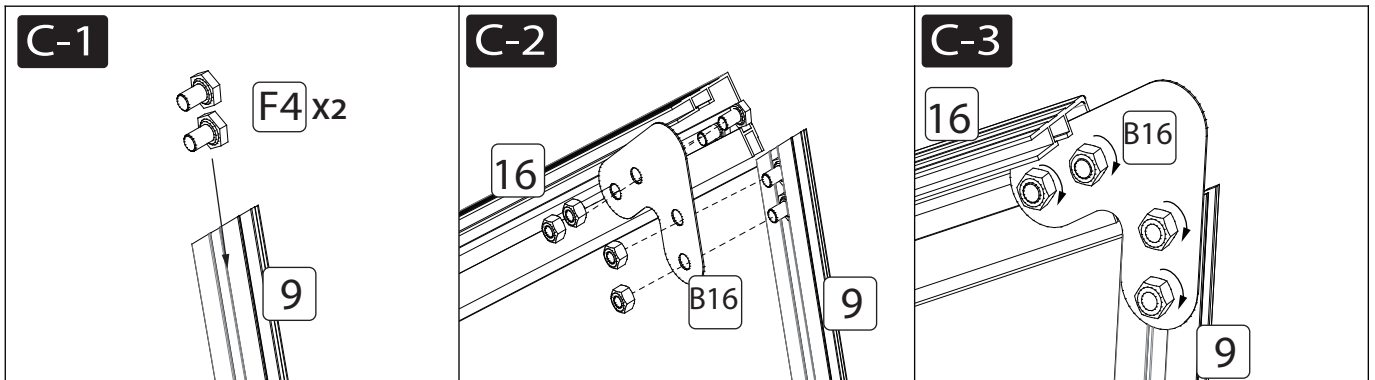
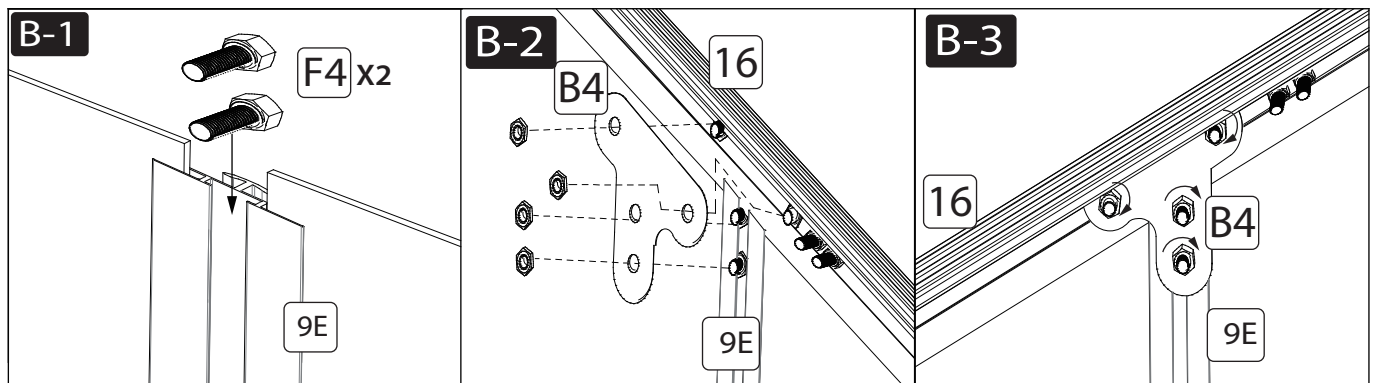
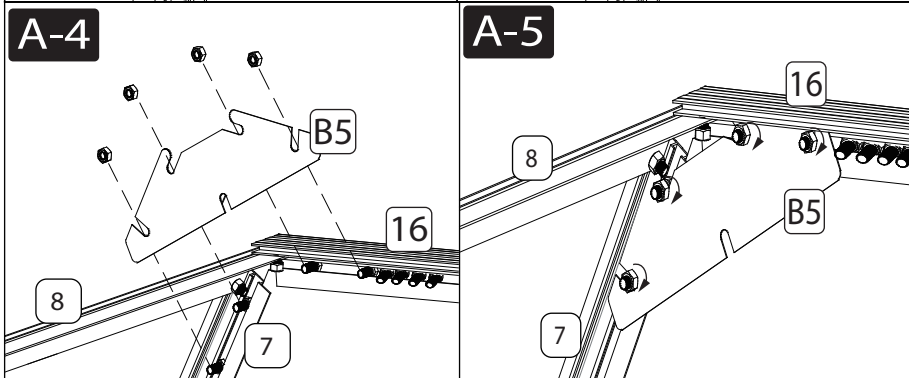
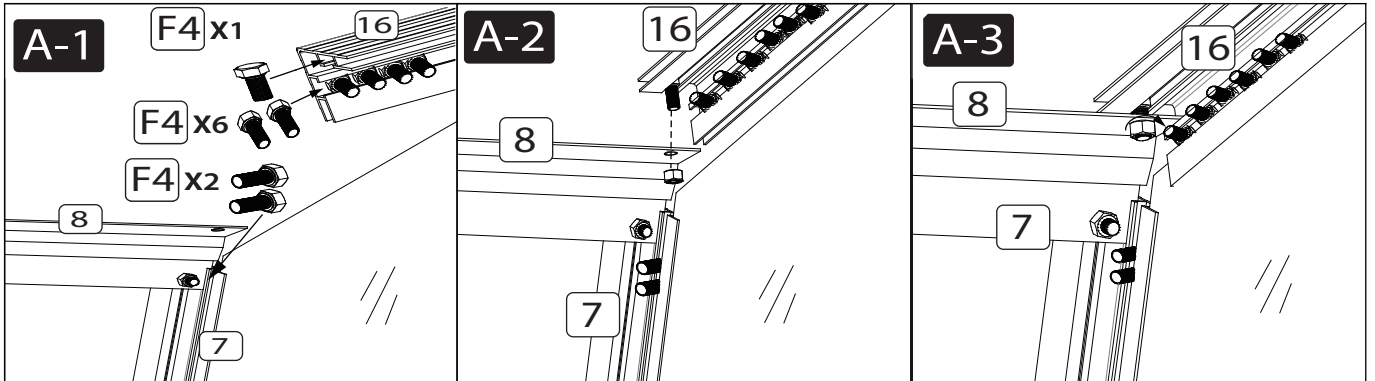

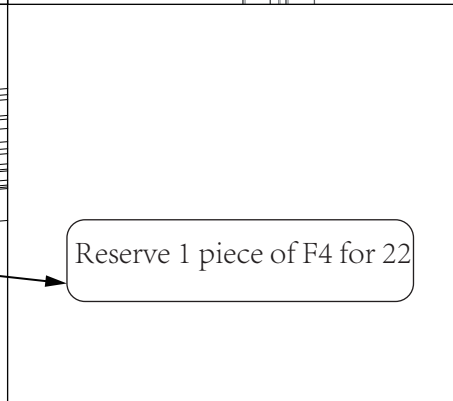
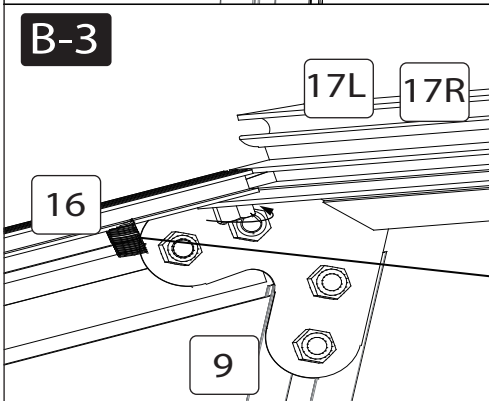
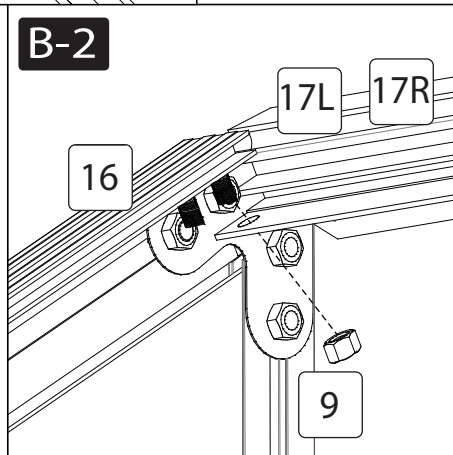
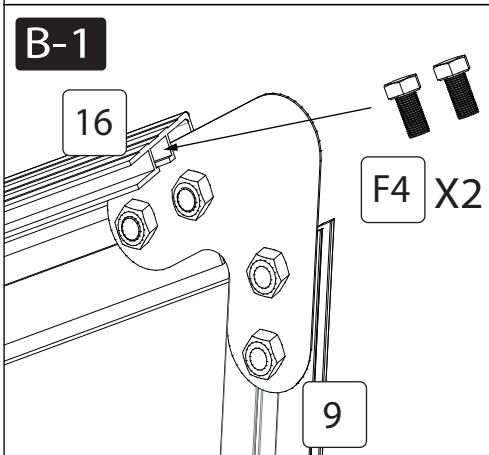
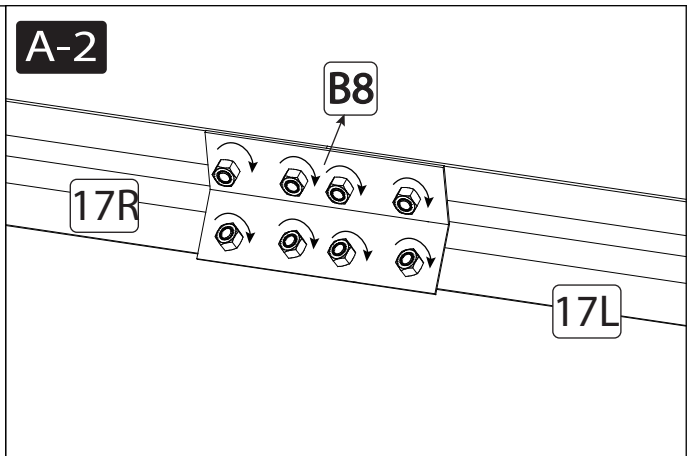
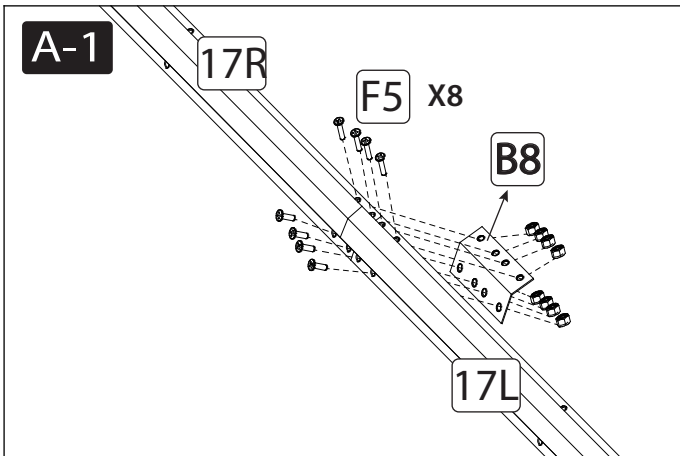
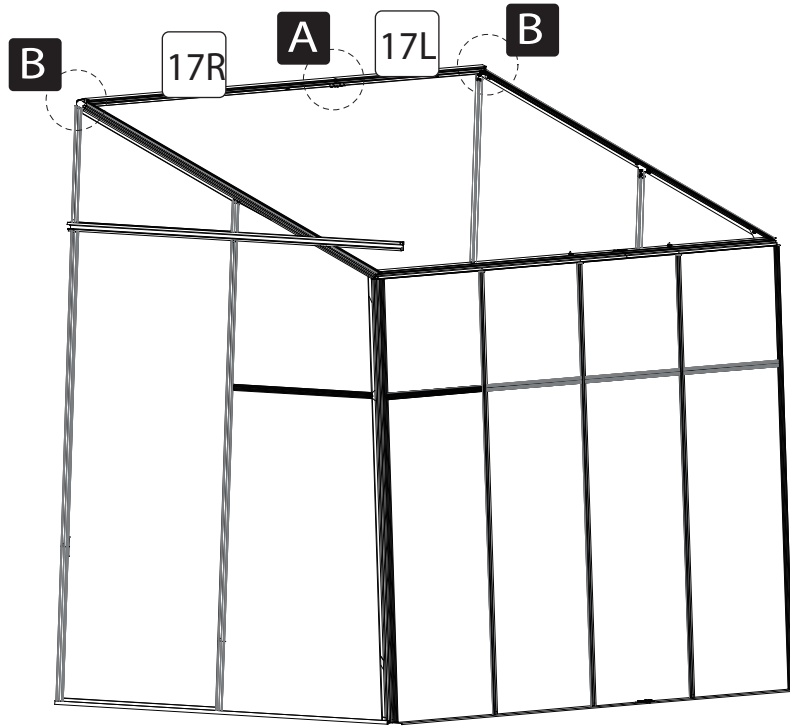

Part No.	Part	Qty.
16		2
B4		2
B5		2
B16		2
F4		26

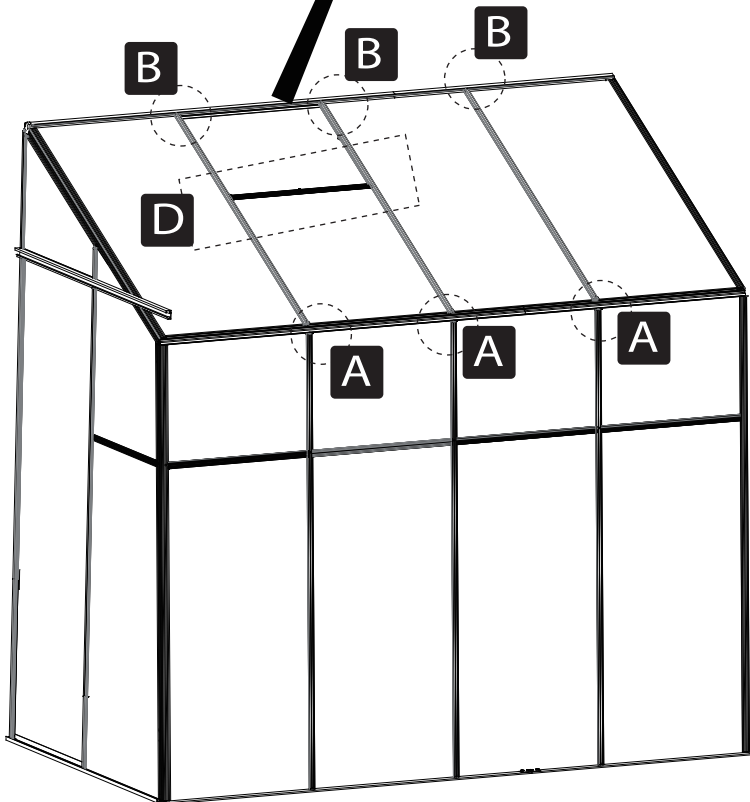
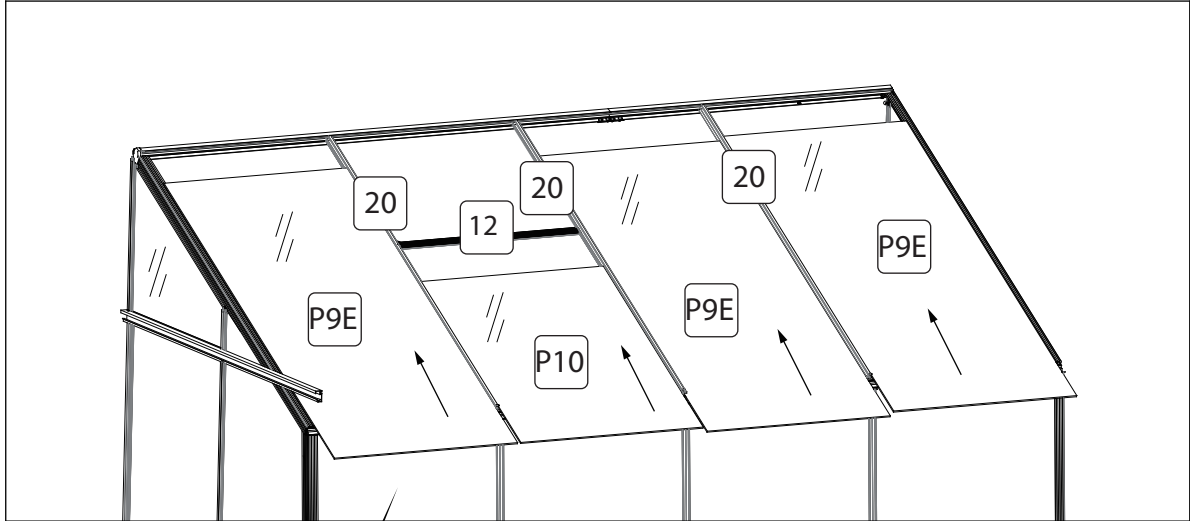



Part No.	Part	Qty.
17R		1
17L		1
B8		1
F5		8
F4		4

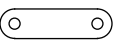

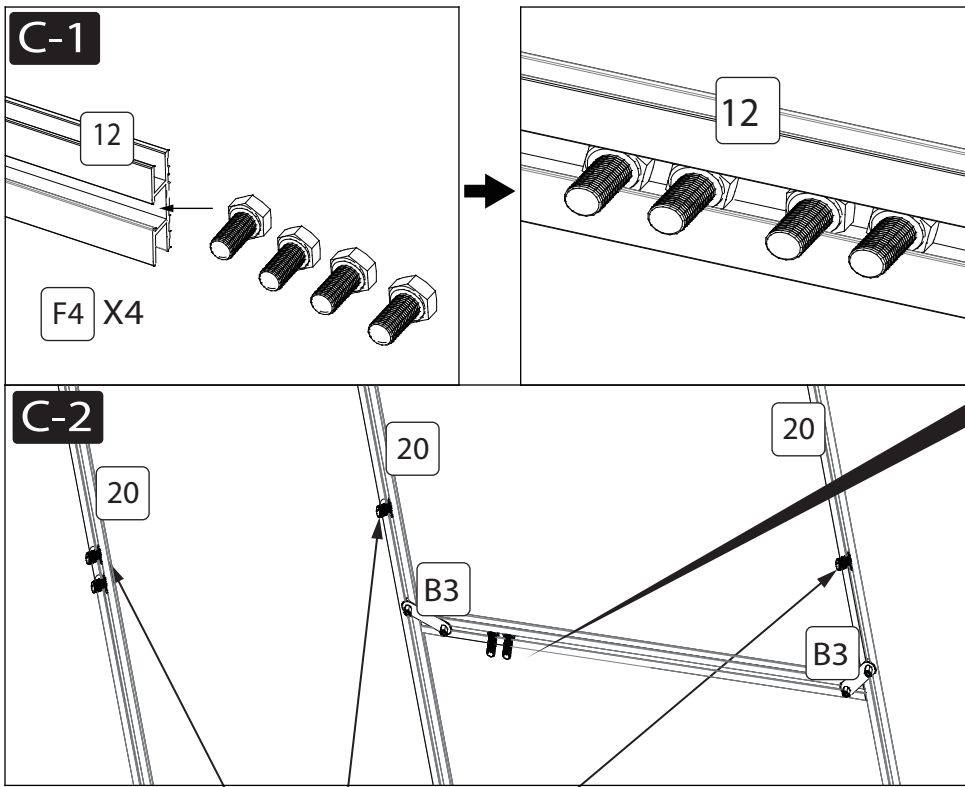
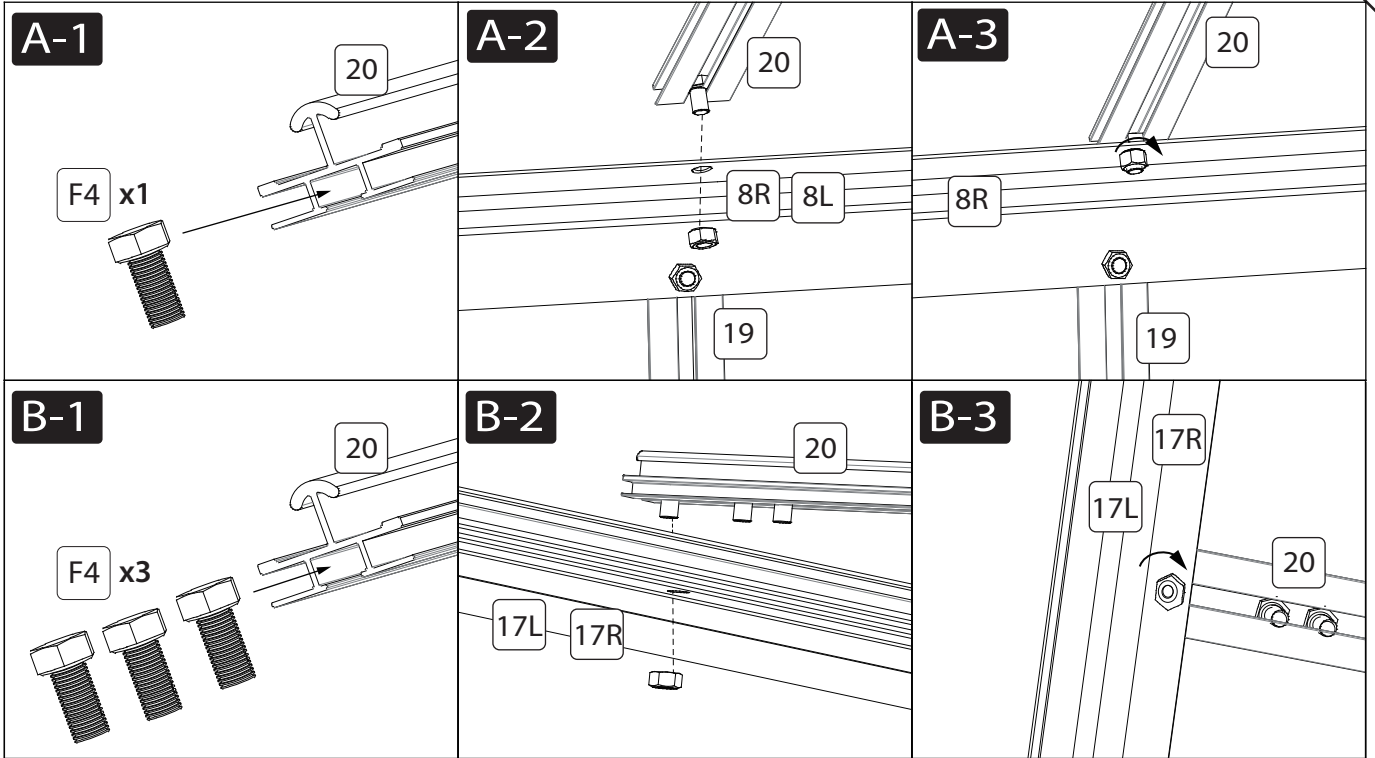

Part No.	Part	Qty.
20		3
12		1
P9E		3
P10		1
B3		2
F4		16



Reserve 2 pieces of F4 for B7

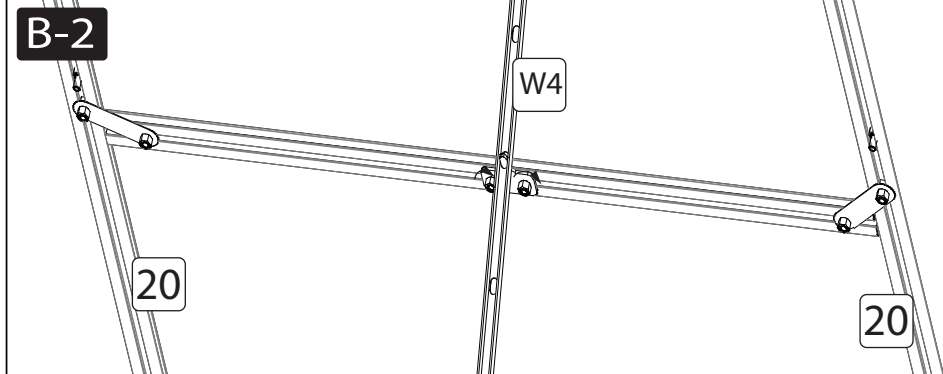
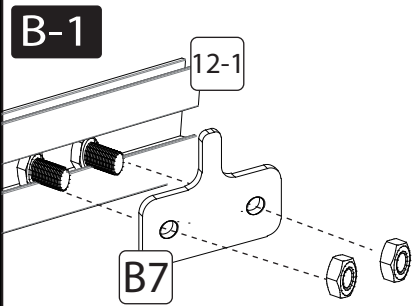
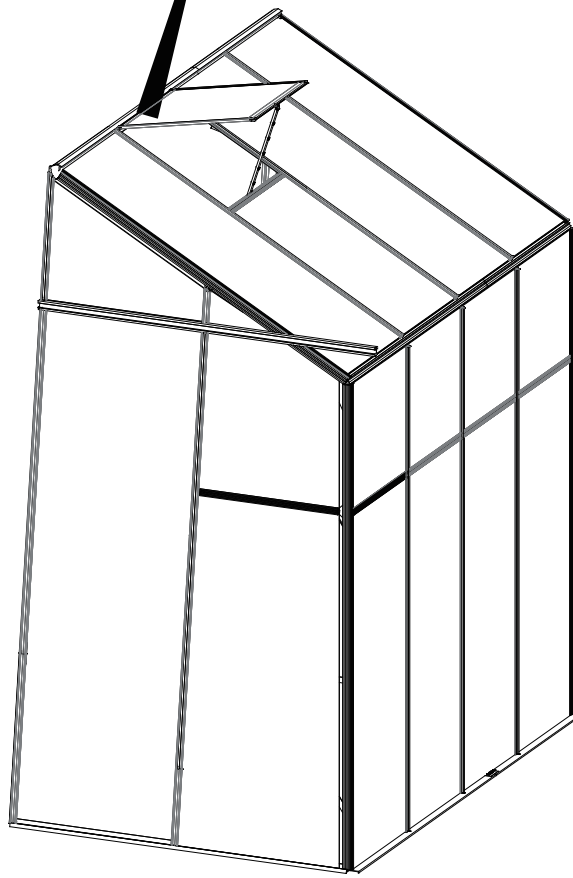
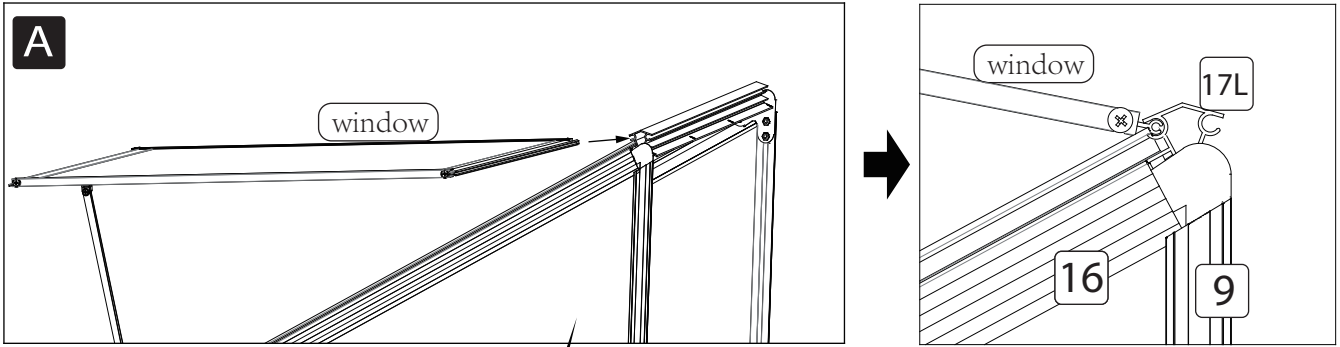

Reserve 4 piece of F4 for 22

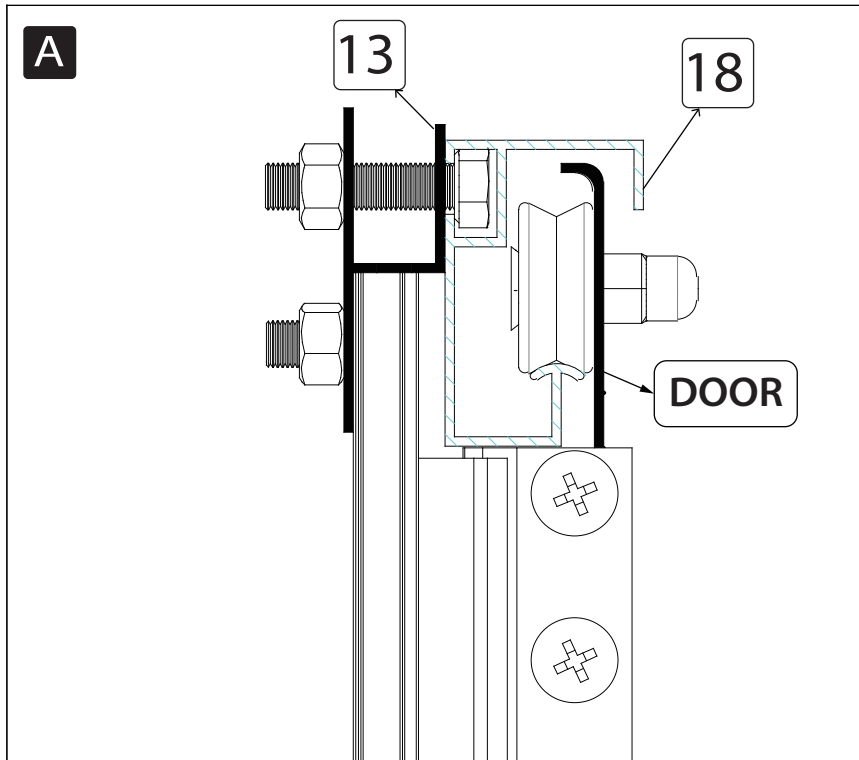
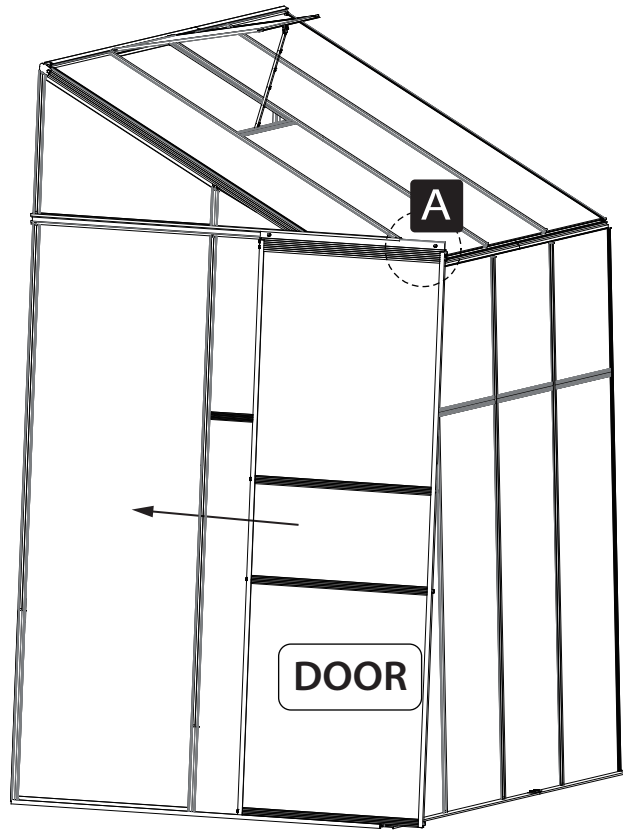

Part No.	Part	Qty.
B7		1

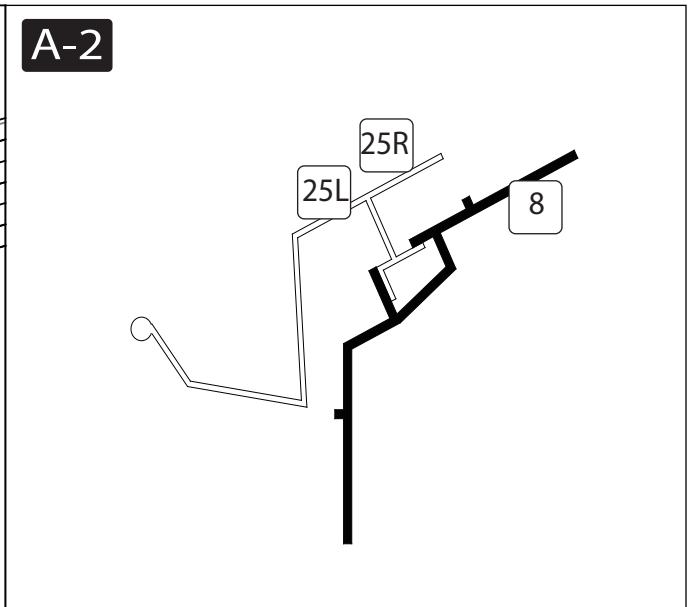
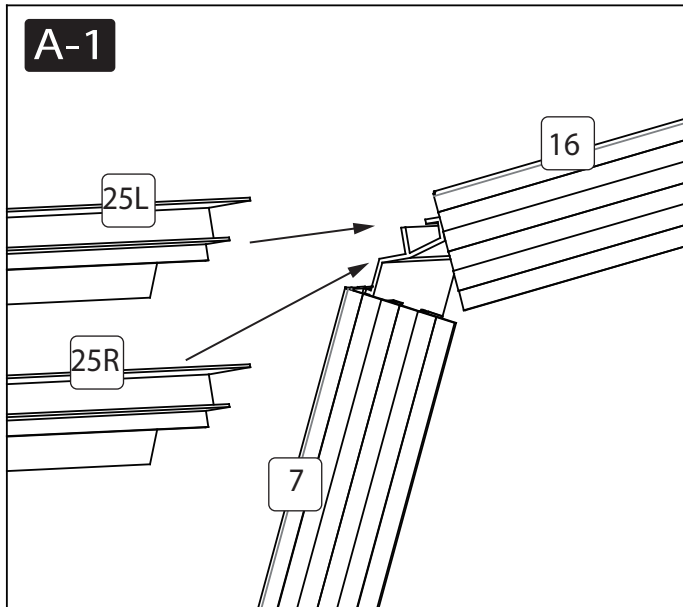
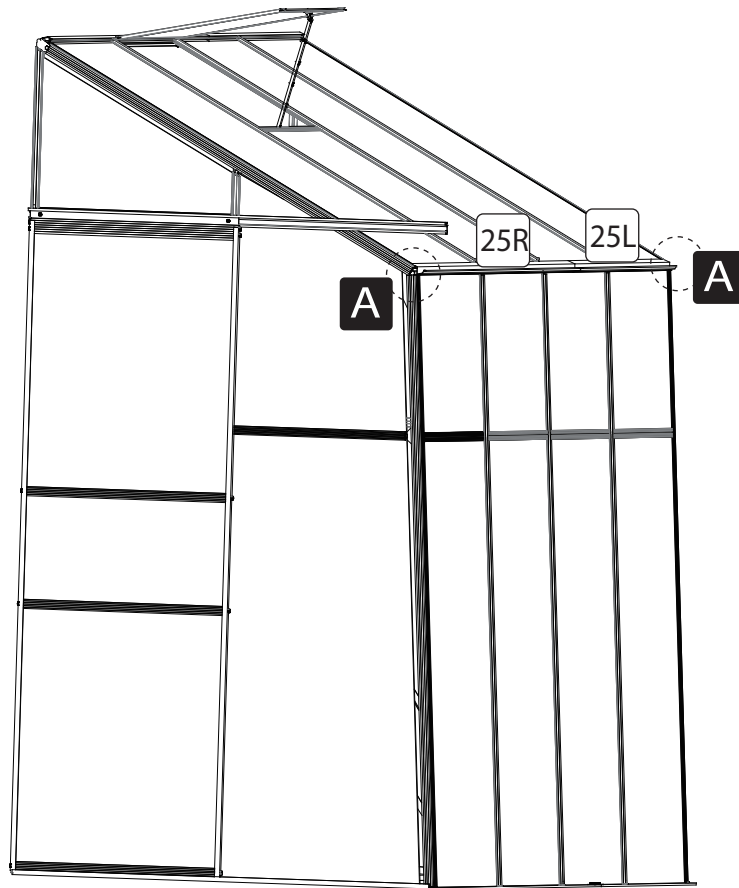

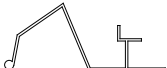

Part No.	Part	Qty.
25L		1
25R		1

inside

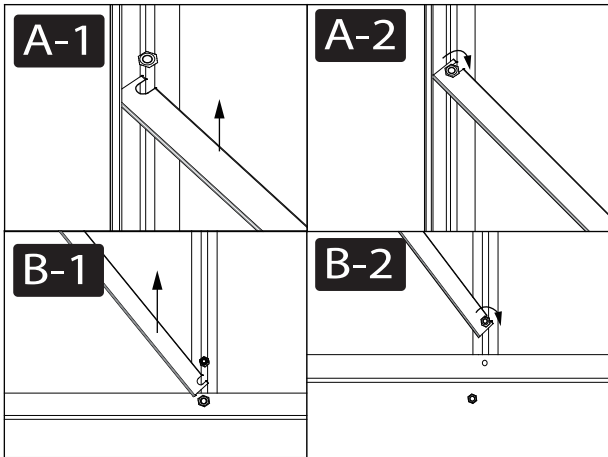
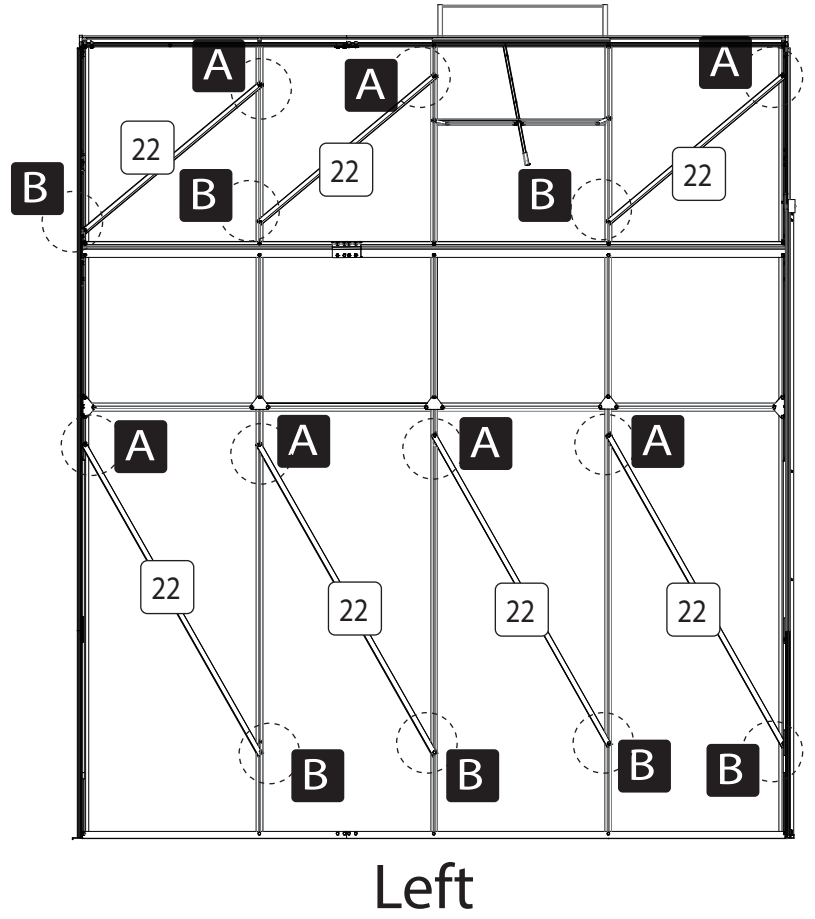
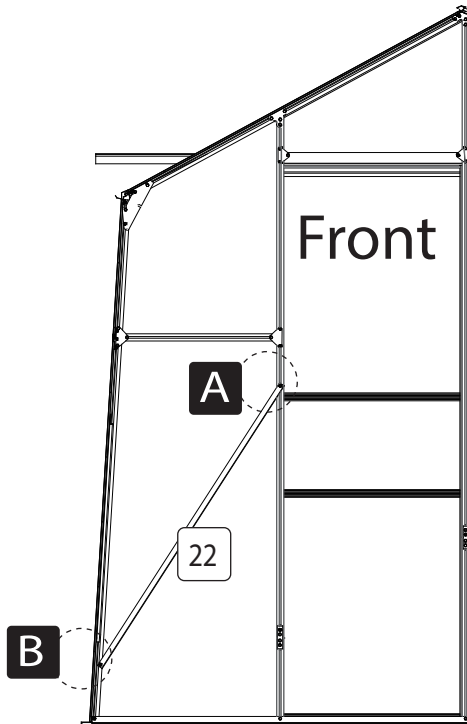
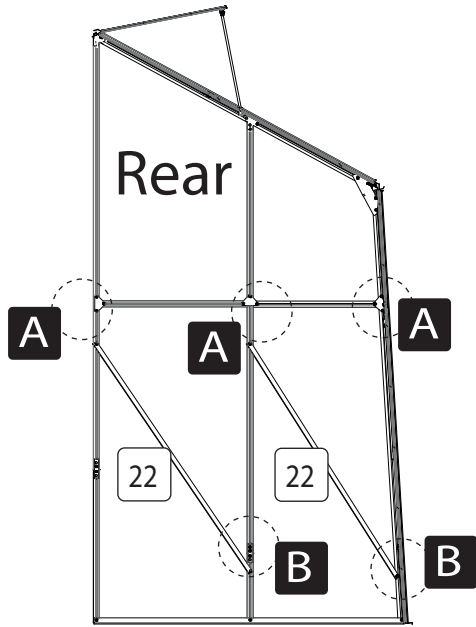

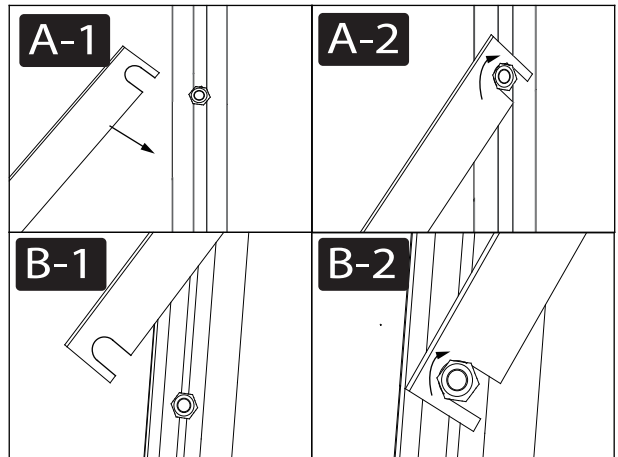

or

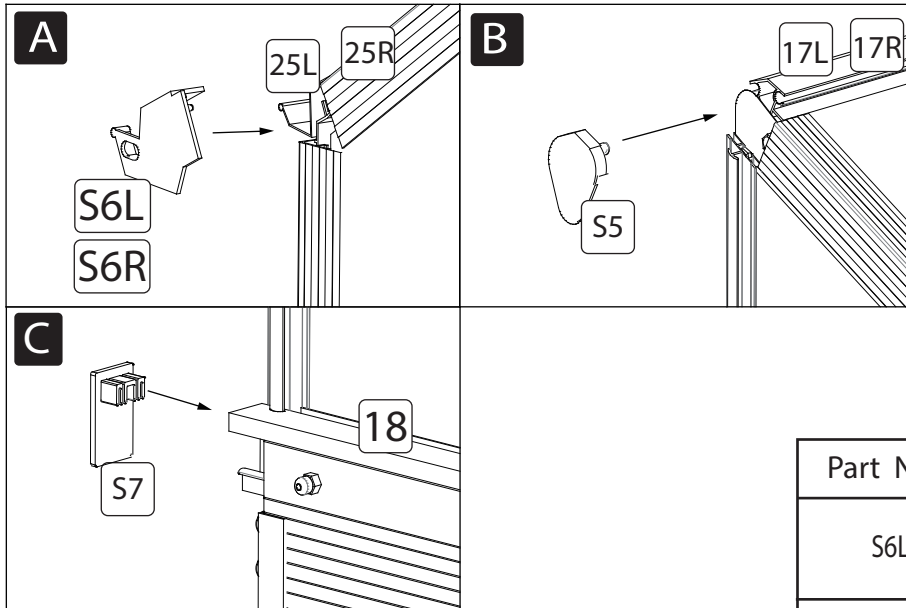
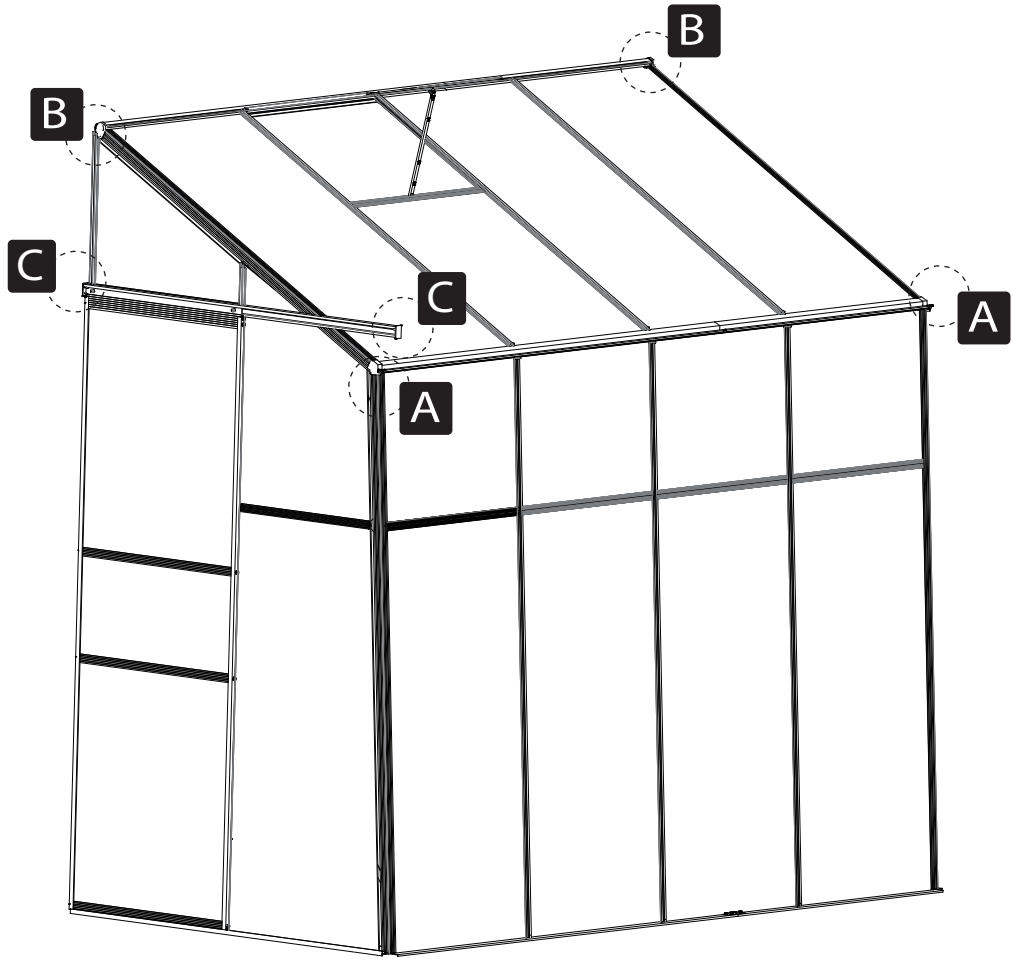

Part No.	Part	Qty.
22		10

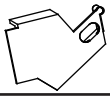

Part No.	Part	Qty.
S6L		1
S6R		1
S5		2
S7		2

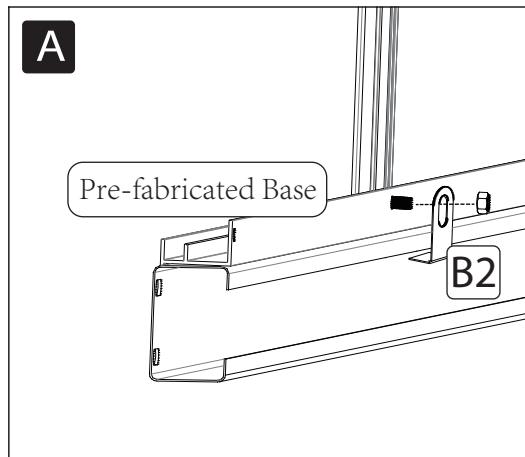
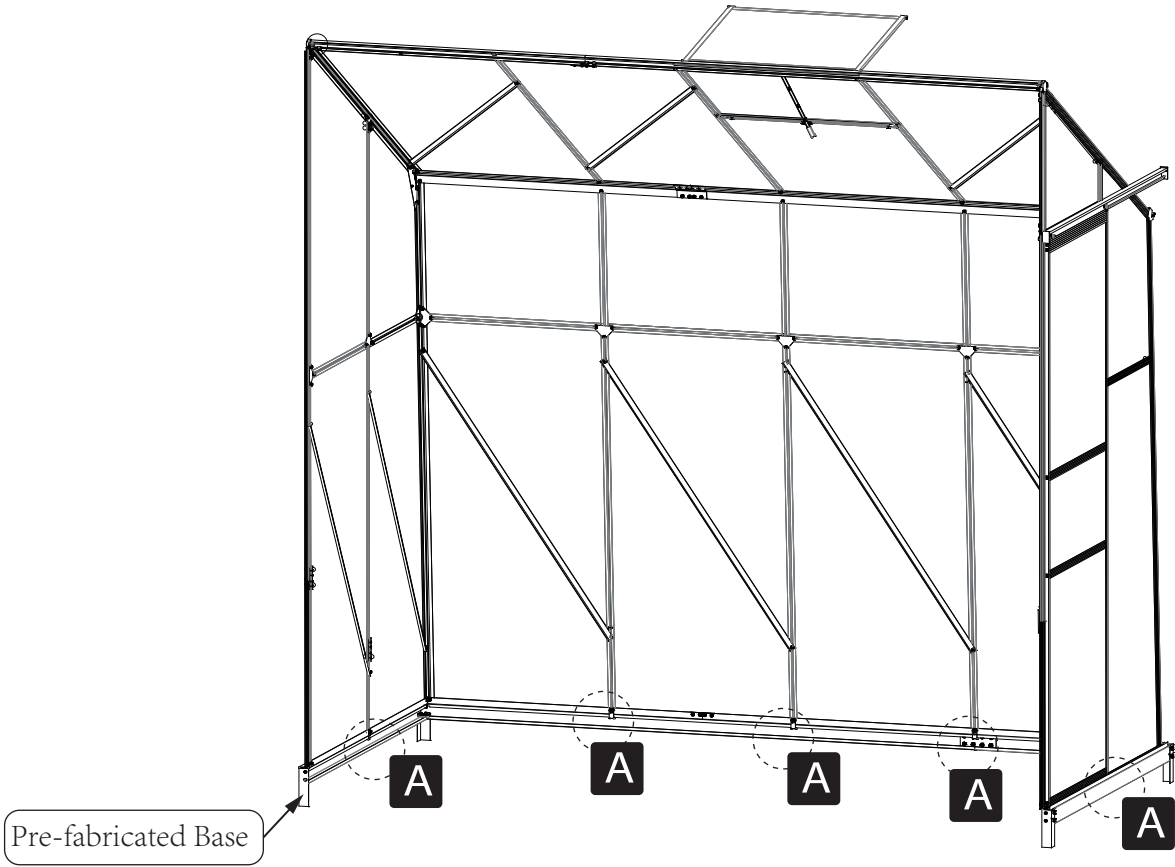

Part No.	Part	Qty.
B2		5

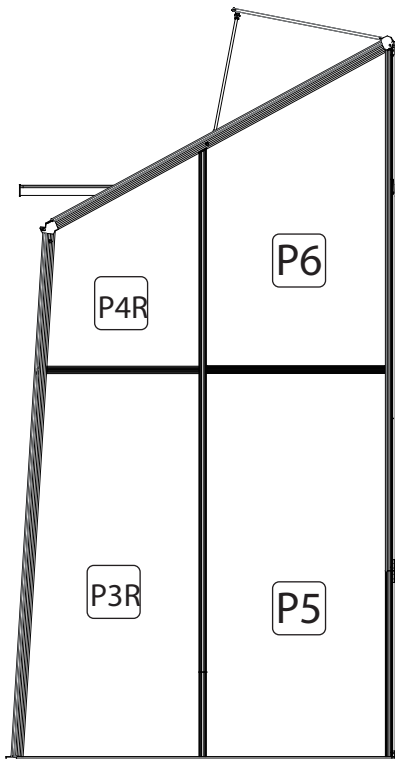

Rear

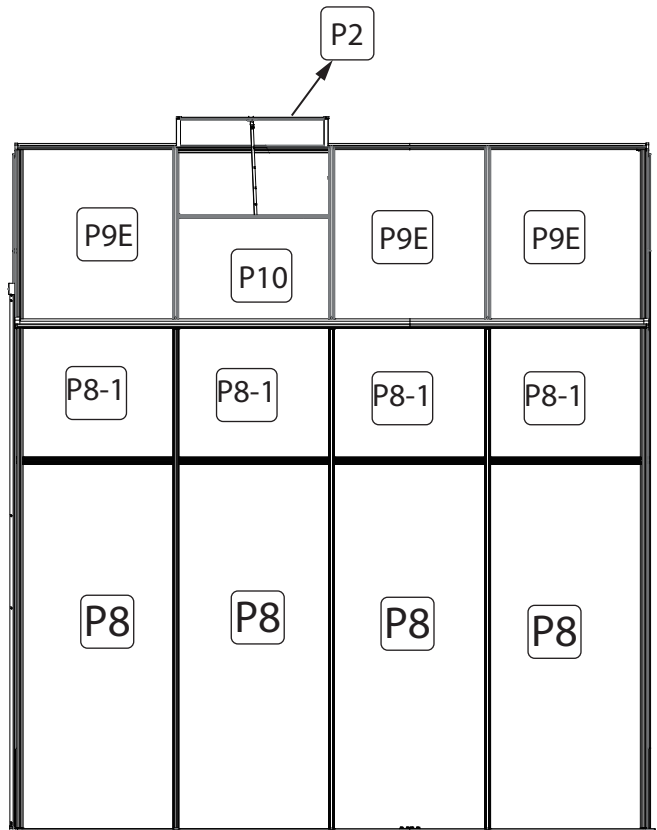

Left

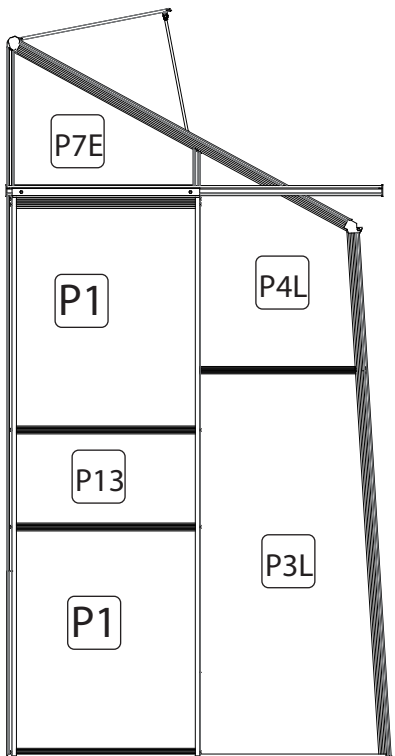

Front

If you have any questions, please contact our customer care center.

Our contact details are below:

 001-877-644-9366

 customerservice@aosom.com

Imported by Aosom LLC

27150 SW Kinsman Rd Wilsonville, OR 97070 USA

MADE IN CHINA

US

Si tiene alguna pregunta, comuníquese con nuestro Centro de Atención al Cliente.

Nuestros datos de contacto son los siguientes:

 0034-931294512

 atencioncliente@aosom.es

IMPORTADOR:

SPANISH AOSOM, S.L.

C/ ROC GROS, Nº 15. 08550, ELS HOSTALETES DE BALENYÀ, SPAIN.

B66295775

WWW.AOSOM.ES

HECHO EN CHINA

ES

If you have any questions, please contact our customer care center.

Our contact details are below:

 416-792-6088

 customerservice@aosom.ca

Imported by Aosom Canada Inc.

7270 Woodbine Avenue, Unit 307, Markham,

Ontario Canada L3R 4B9

MADE IN CHINA

CA

Se tiver alguma dúvida, por favor contacte o nosso Centro de Atendimento ao Cliente.

Os nossos dados de contacto são os seguintes:

 0034-931294512 (SEG-SEX DAS 7:30H ÀS 16:30H)

 info@aosom.pt.

IMPORTADOR:

SPANISH AOSOM, S.L

C.ROC GROS N.15, 08550. ELS HOSTALETES DE BALENYÀ

WWW.AOSOM.PT

PT

Si vous avez la moindre question, veuillez contacter notre centre d'assistance à la clientèle.

Nos coordonnées sont les suivantes:

 416-792-6088

 customerservice@aosom.ca

Importé par Aosom Canada Inc.

7270 Woodbine Avenue, unité 307,

Markham, Ontario Canada L3R 4B9

Fabriqué en Chine

DE

Wenn Sie Fragen haben, wenden Sie sich bitte an unser Kundendienstzentrum.

Unsere Kontaktdaten stehen unten:

 0049-0(40)-88307530  service@aosom.de

ADRESSE DES IMPORTEURS:

MH Handel GmbH

Wendenstraße 309

D-20537 Hamburg

Germany

IN CHINA HERGESTELLT

IT

In caso di dubbio, si prega di contattare il nostro centro assistenza clienti.

I nostri dettagli di contatto sono di seguito:

 0039-0249471447

 clienti@aosom.it

IMPORTATO DA:

AOSOM Italy srl

Centro Direzionale Milanofiori

Strada 1 Palazzo F1

20057 Assago (MI)

P.I.: 08567220960

FATTO IN CINA

UK

If you have any questions, please contact our customer care center.

Our contact details are below:

 0044-800-240-4004

 enquiries@mhstar.co.uk

IMPORTER ADDRESS:

MH STAR UK LTD

Unit 27, Perivale Park,

Horsenden lane South

Perivale, UB6 7RH

MADE IN CHINA

FR

Si vous avez la moindre question, veuillez contacter notre centre d'assistance à la clientèle.

Nos coordonnées sont les suivantes:  0033-1-84166106  aosom@mhfrance.fr

Importé par: MH France 2, rue Maurice Hartmann 92130 Issy-les-Moulineaux

Fabriqué en Chine

France



FR

**DONNEZ
OU
RECYCLEZ**



OU



OU



ASSOCIATION LIVRAISON DÉCHÈTERIE

Adresses sur quefairedemesdechets.fr