



IN231000267V02_GL

844-775V00



EN_IMPORTANT, RETAIN FOR FUTURE REFERENCE: READ CAREFULLY.

FR_IMPORTANT: A LIRE ATTENTIVEMENT ET À CONSERVER POUR CONSULTATION ULTÉRIEURE.

ES_IMPORTANTE, LEA Y GUARDE PARA FUTURAS REFERENCIAS.

PT_IMPORTANTE, RETER PARA REFERÊNCIA FUTURA: LEIA ATENTAMENTE.

DE_WICHTIG! SORGFÄLTIG LESEN UND FÜR SPÄTER NACHSCHLAGEN AUFBEWAHREN.

IT_IMPORTANTE! CONSERVARE IL PRESENTE MANUALE PER FUTURO RIFERIMENTO E LEGGERLO ATTENTAMENTE.

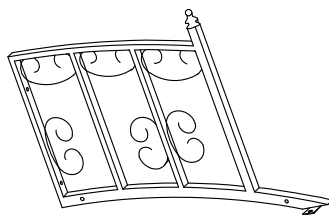
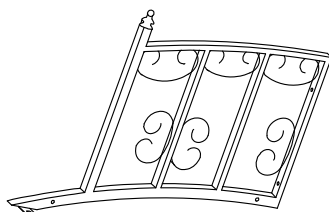
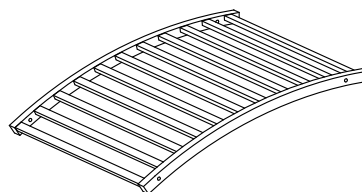
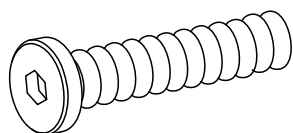
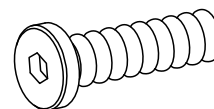
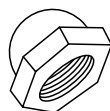
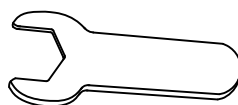
A x02**B** x02**C** x02**D** x08
+1(spare)**E** x04**F** x12
+1(spare)**G** x01**H** x01

EN_Do not confuse similar screws.Do not tighten bolts fully until all parts are connected!

FR_Ne pas confondre des vis similaires.Ne serrez pas les boulons à fond tant que toutes les pièces ne sont pas connectées!

ES_No confunda tornillos similares.No apriete los tornillos completamente hasta que todas las partes están conectadas!

PT_Não confundir parafusos semelhantes. Não apertar completamente os parafusos até que todas as peças estejam encaixadas!

DE_Verwechseln Sie ähnliche Schrauben nicht.Ziehen Sie die Schrauben erst fest an, wenn alle Teile verbunden sind!

IT_Non confondere le viti simili.non serrare completamente i bulloni fino a tutte le parti non sono ancora collegate!

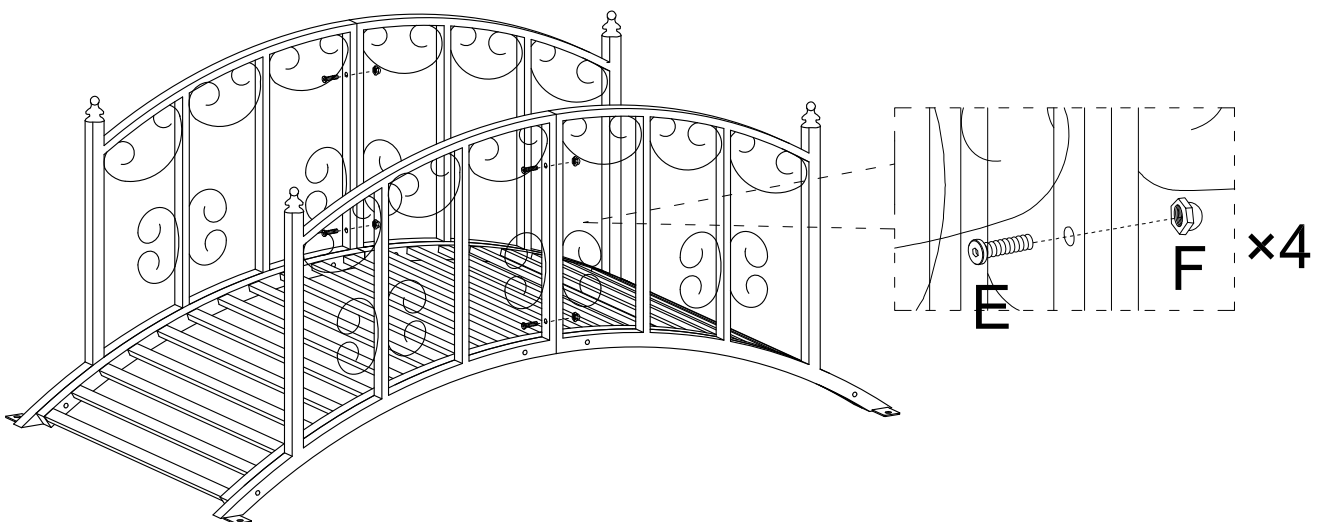
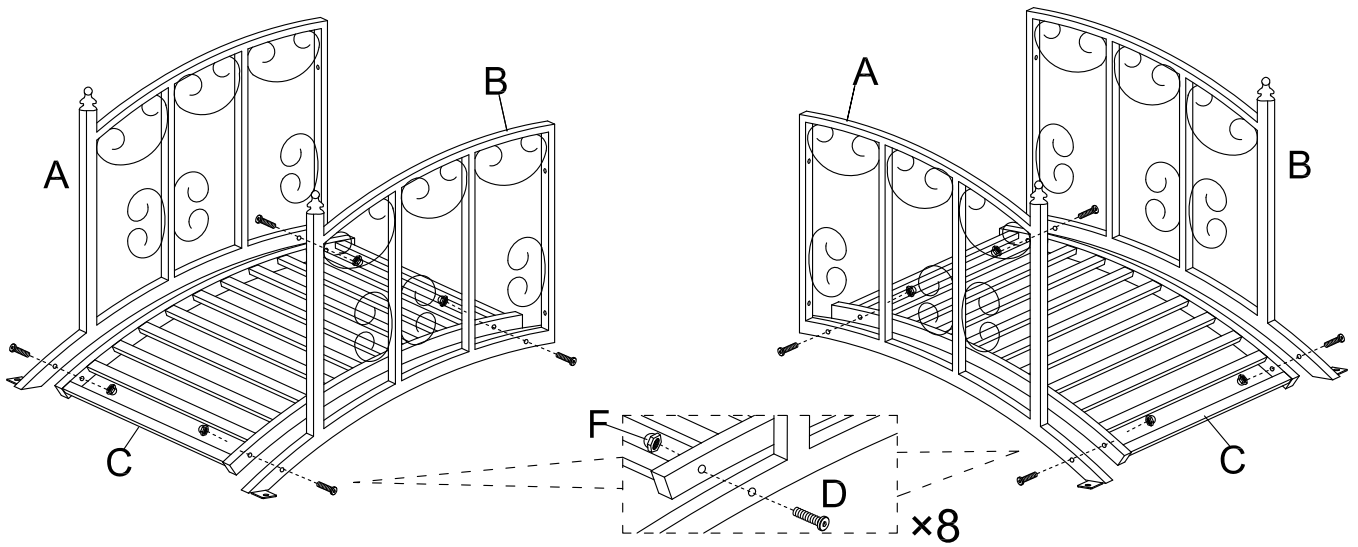

EN After installation, be sure to reinforce the product with expansion screws/ground nails.



FR Après l'installation, veillez à renforcer le produit à l'aide de vis d'expansion/clous de sol.



ES Tras la instalación, asegúrese de reforzar el producto con tornillos de expansión/clavos de tierra.

PT Após a instalação, certifique-se de que reforça o produto com parafusos de expansão/pregos de solo.



DE Nach der Verlegung muss das Produkt mit Dehnschrauben/Bodennägeln verstärkt werden.

IT Dopo l'installazione, assicurarsi di rinforzare il prodotto con viti a espansione/chiodi a terra.

If you have any questions, please contact our customer care center. **US**
Our contact details are below:
 001-877-644-9366
 customerservice@aosom.com
Imported by Aosom LLC
27150 SW Kinsman Rd Wilsonville, OR 97070 USA
MADE IN CHINA

Si tiene alguna pregunta, comuníquese con nuestro Centro de Atención al Cliente. **ES**
Nuestros datos de contacto son los siguientes:
 0034-931294512
 atencioncliente@aosom.es
IMPORTADOR:
SPANISH AOSOM, S.L.
C/ ROC GROS, Nº 15. 08550, ELS HOSTALETES DE BALENYÀ, SPAIN.
B66295775
WWW.AOSOM.ES
HECHO EN CHINA



If you have any questions, please contact our customer care center. **CA**
Our contact details are below:
 416-792-6088
 customerservice@aosom.ca
Imported by Aosom Canada Inc.
7270 Woodbine Avenue, Unit 307, Markham, Ontario Canada L3R 4B9
MADE IN CHINA

Se tiver alguma dúvida, por favor contacte o nosso Centro de Atendimento ao Cliente. **PT**
Os nossos dados de contacto são os seguintes:
 0034-931294512 (SEG-SEX DAS 7:30H ÀS 16:30H)
 info@aosom.pt.
IMPORTADOR:
SPANISH AOSOM, S.L
C.ROC GROS N.15, 08550. ELS HOSTALETES DE BALENYÀ
WWW.AOSOM.PT

Si vous avez la moindre question, veuillez contacter notre centre d'assistance à la clientèle. **FR**
Nos coordonnées sont les suivantes:
 416-792-6088
 customerservice@aosom.ca
Importé par Aosom Canada Inc.
7270 Woodbine Avenue, unité 307, Markham, Ontario Canada L3R 4B9
Fabriqué en Chine

Wenn Sie Fragen haben, wenden Sie sich bitte an unser Kundendienstzentrum. **DE**
Unsere Kontaktdaten stehen unten:
 0049-0(40)-88307530  service@aosom.de
ADRESSE DES IMPORTEUR:
MH Handel GmbH
Wendenstraße 309
D-20537 Hamburg
Germany
IN CHINA HERGESTELLT

If you have any questions, please contact our customer care center. **UK**
Our contact details are below:
 0044-800-240-4004
 enquiries@mhstar.co.uk
IMPORTER ADDRESS:
MH STAR UK LTD
Unit 27, Perivale Park,
Horsenden lane South
Perivale, UB6 7RH
MADE IN CHINA

In caso di dubbio, si prega di contattare il nostro centro assistenza clienti. **IT**
I nostri dettagli di contatto sono di seguito:
 0039-0249471447  clienti@aosom.it
IMPORTATO DA:
AOSOM Italy srl
Centro Direzionale Milanofiori
Strada 1 Palazzo F1
20057 Assago (MI)
P.I.: 08567220960
FATTO IN CINA

Si vous avez la moindre question, veuillez contacter notre centre d'assistance à la clientèle. **FR**
Nos coordonnées sont les suivantes:  0033-1-84166106  aosom@mhfrance.fr
Importé par: MH France 2, rue Maurice Hartmann 92130 Issy-les-Moulineaux
Fabriqué en Chine
France



Adresses sur quefairedemesdechets.fr