

Local air conditioners

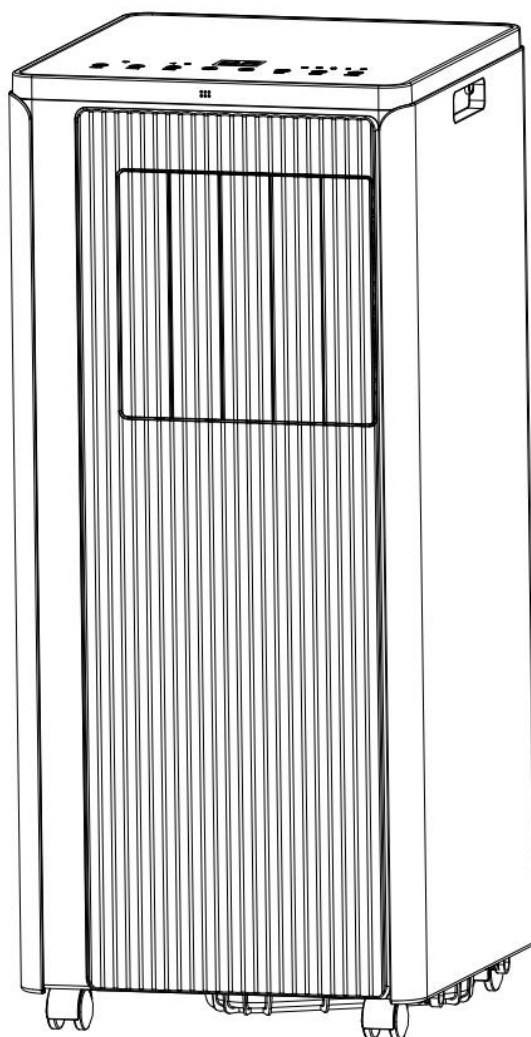

IMPORTANT, RETAIN FOR FUTURE REFERENCE: READ CAREFULLY

Instruction manual

Content

I. Attention Matters.....	3
II. Features and Components.....	4
III. Control Setting.....	6
IV. Protection function.....	8
V. Installation and adjustment.....	9
VI. Drainage Instructions.....	11
VII. Maintenance.....	12
VIII. Unit Storage.....	12
IX. Troubleshooting.....	18
X. Addendum.....	19

The refrigerant used in mobile air conditioners is the environmentally friendly hydrocarbon R290. This refrigerant is odorless, and compared to the alternative refrigerant, the R290 is an ozone-free refrigerant, and its effect is very low.

Please read the instructions before use and repair.

The drawings provided in this manual may not be the same as the physical objects. Please refer to the physical objects.

I. Attention Matters

Warning matters:

1. Do not use means to accelerate the defrosting process or to clean, other than those recommended by the manufacturer.
2. The appliance shall be stored in a room without continuously operating ignition sources (for example: open flames, an operating gas appliance or an operating electric heater.)
3. Do not pierce or burn.
4. Be aware that refrigerants may not contain an odour.
5. Keep any required ventilation openings clear of obstruction;
6. Servicing shall be performed only as recommended by the manufacturer.
7. The appliance shall be stored in a well-ventilated area where the room size corresponds to the room area as specified for operation.
8. Any person who is involved with working on or breaking into a refrigerant circuit should hold a current valid certificate from an industry-accredited assessment authority, which authorizes their competence to handle refrigerants safely in accordance with an industry recognized assessment specification.
9. Servicing shall only be performed as recommended by the equipment manufacturer. Maintenance and repair requiring the assistance of other skilled personnel shall be carried out under the supervision of the person competent in the use of flammable refrigerants.
10. All working procedure that affects safety means shall only be carried by competent persons.



Notes:

- * The air conditioning is only suitable for indoor use, and is not suitable for other applications.
- * Follow local grid interconnection rules while installing the air conditioning and ensure that it is properly grounded. If you have any question on electrical installation, follow the instructions of the manufacturer, and if necessary, ask a professional electrician to install it.
- * Place the machine in a flat and dry place and keep a distance of above 50cm between the machine and the surrounding objects or walls.
- * After the air conditioning is installed, ensure that the power plug is intact and firmly plugged into the power outlet, and place the power cord orderly to prevent someone from being tripped or pulling out the plug.
- * Do not put any object into the air inlet and outlet of the air conditioning. Keep the air inlet and outlet free from obstructions.
- * When drainage pipes are installed, ensure that the drainage pipes are properly connected, and are not distorted or bended.
- * While adjusting the upper and lower wind-guide strips of the air outlet, pluck it with hands gently to avoid damaging wind-guide strips.
- * When moving the machine, make sure that it is in an upright position.
- * The machine should stay away from gasoline, flammable gas, stoves and other heat sources.

- * Don't disassemble, overhaul and modify the machine arbitrarily, otherwise it will cause a machine malfunction or even bring harm to persons and properties. To avoid danger, if a machine failure occurs, ask the manufacturer or professionals to repair it.
- * Do not install and use the air conditioning in the bathroom or other humid environments.
- * Do not pull the plug to turn off the machine.
- * Do not place cups or other objects on the body to prevent water or other liquids from spilling into the air conditioning.
- * Do not use insecticide sprays or other flammable substances near the air conditioning.
- * Do not wipe or wash the air conditioning with chemical solvents such as gasoline and alcohol. When you need to clean the air conditioning, you must disconnect the power supply, and clean it with a half-wet soft cloth. If the machine is really dirty, scrub with a mild detergent.
- * The appliance can be used by children aged from 8 years and above and persons with reduced physical, sensory or mental capabilities if they have been given supervision or instruction concerning use of the appliance in a safe way and understand the hazards involved. Children shall not play with the appliance. Cleaning and maintenance shall not be made by children without supervision.
- * If the supply cord is damaged, it must be replaced by the manufacturer, its service agent or similarly qualified persons in order to avoid a hazard.
- * The appliance shall be installed in accordance with national wiring regulations.
- * Do not operate your air conditioner in a wet room such as a bathroom or laundry room.

Transportation, marking and storage for units

1. Transport of equipment containing flammable refrigerants, Compliance with the transport regulations.
2. Marking of equipment using signs, Compliance with local regulations
3. Disposal of equipment using flammable refrigerants, Compliance with national regulations
4. Storage of equipment/appliances
 - * The storage of equipment should be in accordance with the manufacturer's instructions.
5. Storage of packed (unsold) equipment
 - * Storage package protection should be constructed such that mechanical damage to the equipment inside the package will not cause a leak of the refrigerant charge.
 - * The maximum number of pieces of equipment permitted to be stored together will be determined by local regulations.

II. Features and Components

1. Features

- * Brand new appearance, compact structure, smooth line, simple and generous shape.
- * Functions of refrigeration, dehumidification, air supply and continuous drainage
- * Outdoor interface is set high to facility assembly and keep the smooth flow of the heat pipe.
- * LED displays the control panel, beautiful and fashionable, with high-quality remote control. It adopts a user-friendly remote control design.
- * Air filtration capability.
- * Timing switch function.
- * Protection function of automatically restarting the compressor after three minutes, a variety of other protection functions.
- * The Max operation temperature for the air conditioner Cooling: 35/24°C; heating:20/12°C; Temperature operation range: 7-35°C.

2. Components:

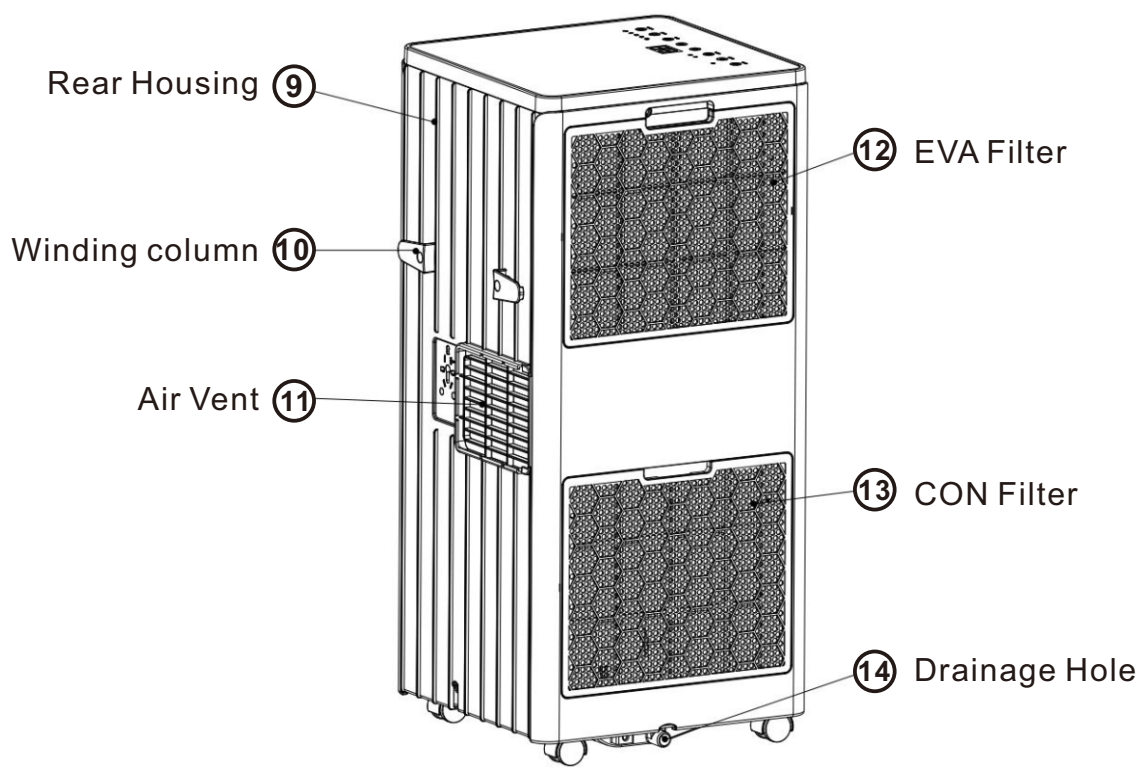
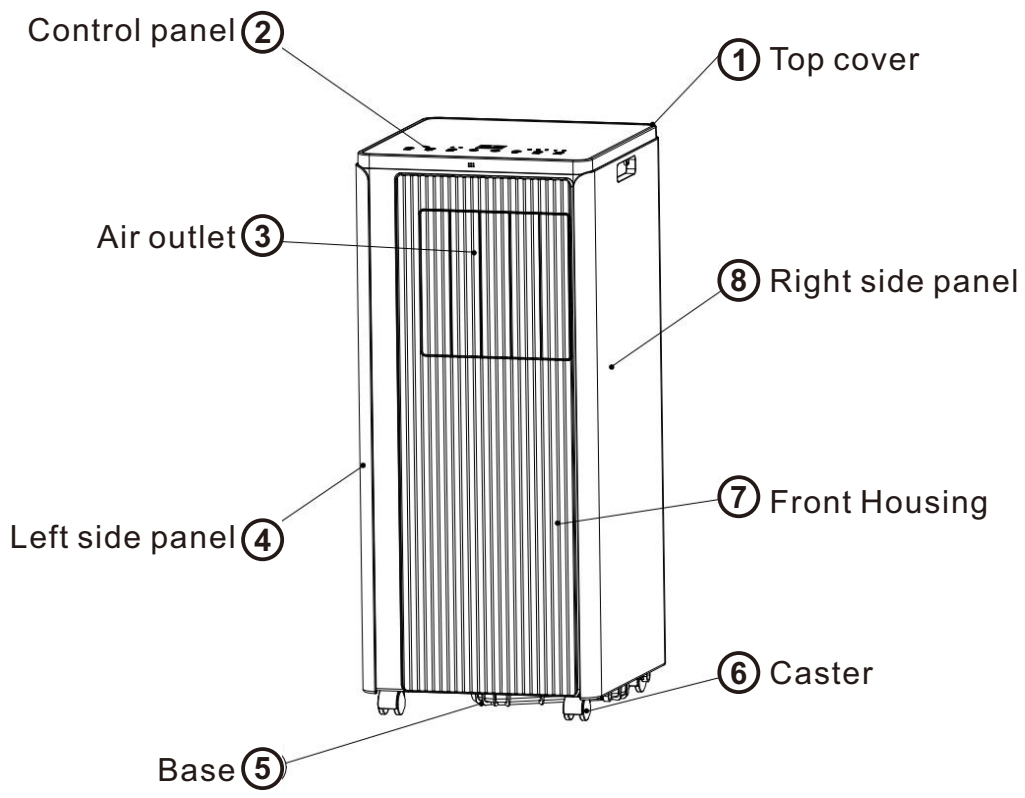

Window Sealing Plate Assembly



Exhaust Pipe Assembly

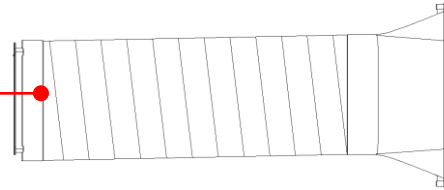

III. Control Setting

1. Control panel operation instructions

1) Operation interface:

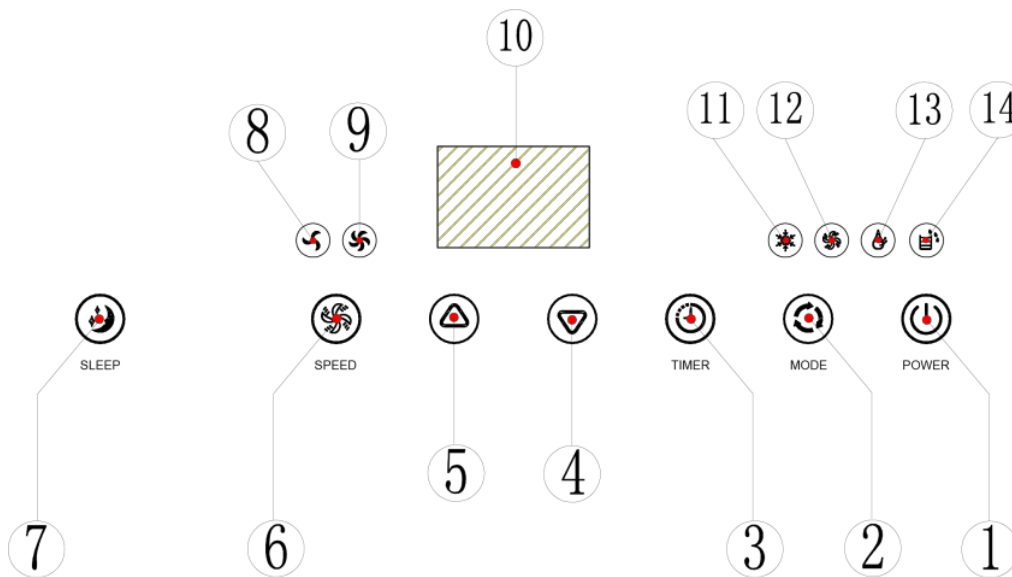

- | | | | |
|--------------|--------------|--------------|------------------|
| 1. Power Key | 4. Down Key | 7. Sleep | 11. Cool |
| 2. Mode Key | 5. Up Key | 8. Low wind | 12. Fan |
| 3. Timer Key | 6. Speed Key | 9. High wind | 13. Dehumidifier |
| | | 10. Display | 14. Water Full |

1: When the machine is powered on for the first time, The machine sounded, and then the machine will get into standby status.

2: Power Key: press the key to turn on and turn off the machine. In the case of power on, press the key to turn off the machine; in the case of power off, press the key to turn on the machine.

3: Mode Selection Key: In the case of power on, press the key to switch between cooling → fan → dehumidifying mode.

4: Up Key and Down Key: press the two keys to change the setting temperature or setting time, operate as follows:

While setting temperature, press up key or down key to select the required temperature (not available in fan or dehumidifying mode).

While setting time, press up key or down key to select the required time.

5: Wind Speed Selection Key:

1) In cooling and fan mode, press the key to select high, low wind speed operation. But limited by anti-cold conditions, under certain conditions, it may not run according to the set wind speed.

2) In dehumidifying mode, pressing the key is invalid, and the fan will forcibly choose low wind speed operation.

6: Timer Key:

In the case of power on, press the key to close timing; in the case of power off, press the key to open timing.

Press the key, when the timing symbol flashes, press up and down key to select the required timing value.

Timing values can be set in 1-24 hours and the timing value is adjusted up or down by one hour.

7: Sleep Mode:

In the cooling Mode, Press the Sleep Key to turn on the sleep mode, then the unit will work on Energy-Saving and quiet type.

8: Information on the WIFI App “Smart Life - Smart Living”

The Smart Life - Smart Living app is available for android and iOS. Scan the corresponding QR code to get directly to the download.

NOTE:

Depending on the provider, there may be costs involved in downloading the app.



Google Play



App Store

Information on How to Use the App

This appliance allows you to operate the appliance via your home net-work.

A prerequisite is a permanent Wi-Fi connection to your router and the free app “Smart Life - Smart Living”.

You can easily access all functions of the appliance via the app. Since the app constantly improved, we cannot provide a more detailed description here.

We recommend disconnecting the appliance from the power supply when you are away from home to prevent unintentional switching on while you are on the road!

System Requirement for Use of the App

- iOS 8.0 or higher
- Android 4.4 or higher

Commissioning via the App

1. Install the “Smart Life - Smart Living” app. Create a user account.
2. Activate the Wi-Fi function in the settings of your appliance.
3. Place the air-conditioning appliance within a distance of around 5 meters of your router.
4. The device can be added when the air conditioner is in standby mode, the indicator WIFI on the control panel will blink quickly. To do so, press and hold down the SPEED button for approx 5 seconds. If the indicator blinks slowly, repeat the operation.
5. Launch the app and select “+”.
6. Select the “air conditioner” menu and follow the instructions on the display.

7. The correct connection of the air conditioner to the app is signaled by the constant illumination of the indicator power. Now you can operate the appliance using the app.

NOTE:





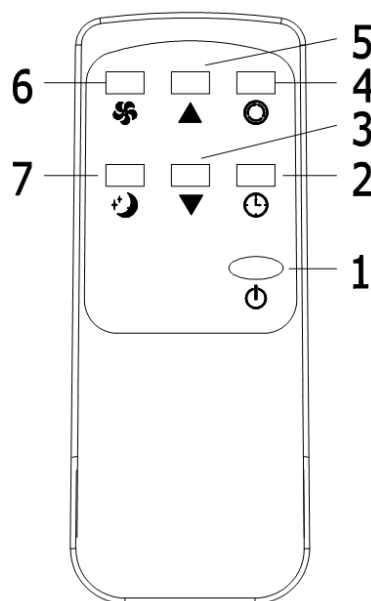

- The appliance can only be operated with 2.4 GHz routers. 5 GHz routers are not supported.
- The appliance is equipped with only one network connection. It can not be turned off.

1. Operation instructions of remote control

1) The remote control Panel is as follows:



Instructions of key operation of the high-quality remote control are as follows:

1. Power: Press  the key to turn on or turn off the machine.
2. Timer: press  the key to set timing.
3. Down: press  the key to reduce temperature and timing set value.
4. Mode: press  the key to switch between cooling, fan, dehumidifying mode.
5. Up: press  the key to increase temperature and timing set value.
6. Fan: press  the key to select high, low wind speed.
7. Sleep Mode: Press  the key to turn on the sleep mode.

IV. Protection function

3.1 Frost Protection Function:

In cooling, dehumidifying or economic power saving mode, if the temperature of the exhaust pipe is too low, the machine will automatically enter protection status; if the temperature of the exhaust pipe rises to a certain temperature, it can automatically revert to normal operation.

3.2 Overflow Protection Function:

When water in the water pan exceeds the warning level, the machine will automatically sound an alarm, and the "FULL" indicator light will flash. At this point, you need to

move the drainage pipe connecting the machine or the water outlet to sewer or other drainage area to empty the water (details see Drainage Instructions at the end of this chapter). After the water is emptied, the machine will automatically return to the original state.

3.3 Protection Function of the Compressor

To increase the service life of the compressor, it has a 3-minute delay booting protection function after the compressor is turned off.

V. Installation and adjustment

1.Installation:

Warning: before using the mobile air conditioning, keep it upright for at least two hours.

The air conditioning can be easily moved in the room. In the moving process, ensure that the air conditioning is in the upright position and the air conditioning should be placed on a flat surface. Do not install and use the air conditioning in the bathroom or other humid environments.

1.1 Install the heat pipe assembly (as shown in Fig.1)

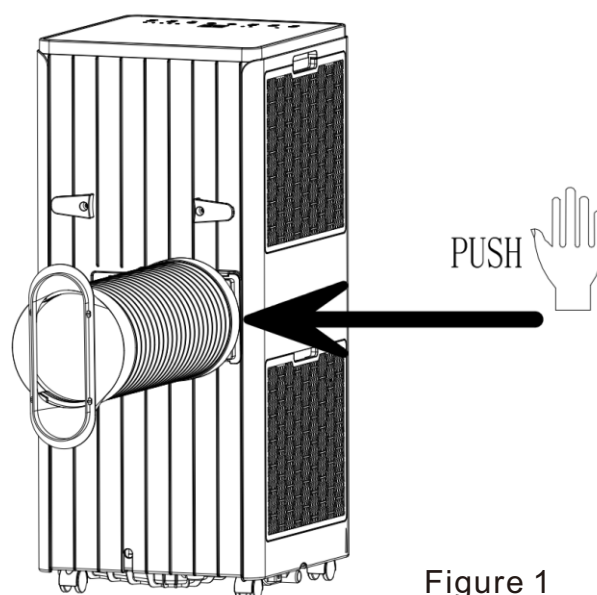

Figure 1

- 1) Take out the outer connector assembly and the exhaust pipe assembly, and remove the plastic bags;
- 2) Insert the heat pipe assembly (the end of the exhaust joint) into the back panel vent slot (push to the left) and complete the assembly (as shown in figure 1).

1.2 Installation of window sealing plate components

- 1) Half open the window, and mount the window sealing plate assembly to the window (as shown in Fig.2 and Fig.3). Components can be placed in horizontal and vertical direction.
- 2) Pull various components of the window sealing plate assembly open, adjust their opening distance to bring both ends of the assembly into contact with the window frame, and fix various components of the assembly.

Notes:

- 1) The flat end of the exhaust pipe joints must be snapped into place.
- 2) The pipe cannot be distorted nor has substantial turning (greater than 45 °). Keep the ventilation of the exhaust pipe not blocked.

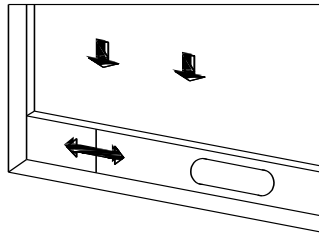

Figure 2

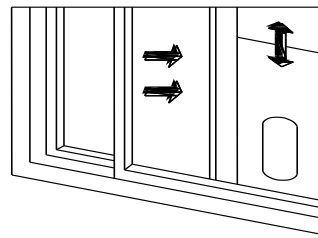

Figure 3

1.3 Install the body

- 1) Move the machine with installed heat pipe and fittings before the window, and the distance between the body and walls or other objects shall be least 50 cm (as shown in Fig.4).

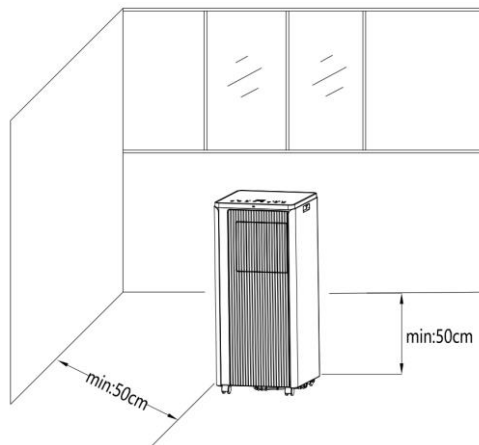

Figure 4

- 3) Elongate the exhaust pipe and snap the flat end of the exhaust pipe joints into the hole of the window sealing plate assembly (as shown in Fig.5 and Fig.6).

Notes:

1. The flat end of the exhaust pipe joints must be snapped into place.
2. The pipe cannot be distorted nor has substantial turning (greater than 45 °). Keep the ventilation of the exhaust pipe not blocked.

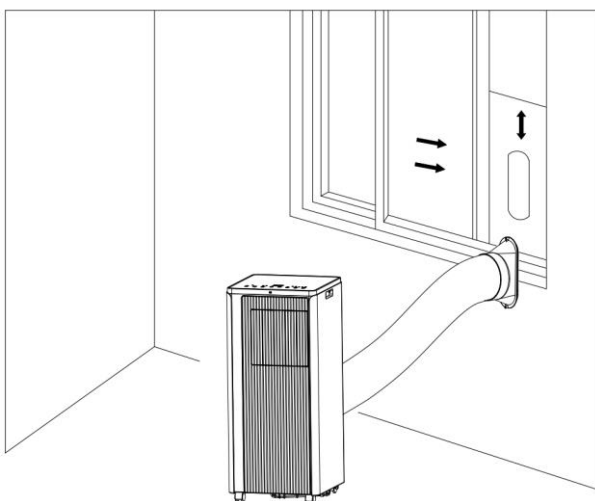

Figure 5

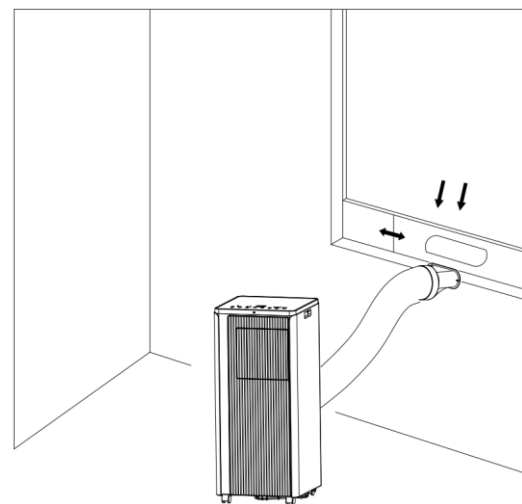

Figure 6

Important Notice:

The length of the exhaust hose shall be 280~1,500mm, and this length is based on the specifications of the air conditioning. Do not use extension tubes or replace it with other different hoses, or this may cause a malfunction. Exhaust host must be not blocked; otherwise it may cause overheating.

VI. Drainage Instructions

This machine has two drainage methods: manual drainage and continuous drainage.

1. Manual drainage:

- 1) When the machine stops after the water is full, turn off the machine power and unplug the power plug.

Notes: Please move the machine carefully, so as not to spill the water in the water pan at the bottom of the body.

- 2) Place the water container below the side water outlet behind the body.
- 3) Unscrew the drainage cover and unplug the water plug, the water will automatically flow into the water container.

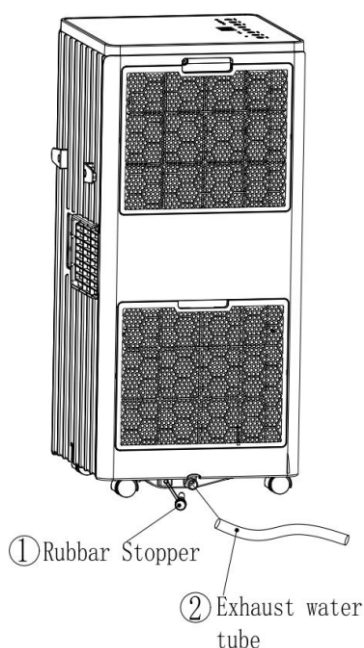

Notes:

- 1) Keep the drainage cover and the water plug properly.
- 2) During drainage, the body can be tilted slightly backwards.
- 3) If the water container cannot hold all the water, before the water container is full, stuff the water outlet with the water plug as soon as possible to prevent water from flowing to the floor or the carpet.
- 4) When the water is discharged, stuff the water plug, and tighten the drainage cover.

2. Continuous drainage (Optional) (only applicable to dehumidifying mode), as shown in figure:

- 1) Unscrew the drainage cover, and unplug the water plug.
- 2) Set the drainage pipe into the water outlet.
- 3) Connect the drainage pipe to the bucket.

VII. Maintenance

Cleaning: before cleaning and maintenance, turn off the machine and unplug the plug.

1. Clean the surface

Clean with surface of machine with a wet soft cloth. Don't use chemicals, such as benzene, alcohol, gasoline, etc; otherwise, the surface of the air conditioning will be damaged or even the whole machine will be damaged.

2. Clean the filter screen

If the filter screen is clogged with dust, and the effectiveness of the air conditioning is reduced, be sure to clean the filter screen once every two weeks.

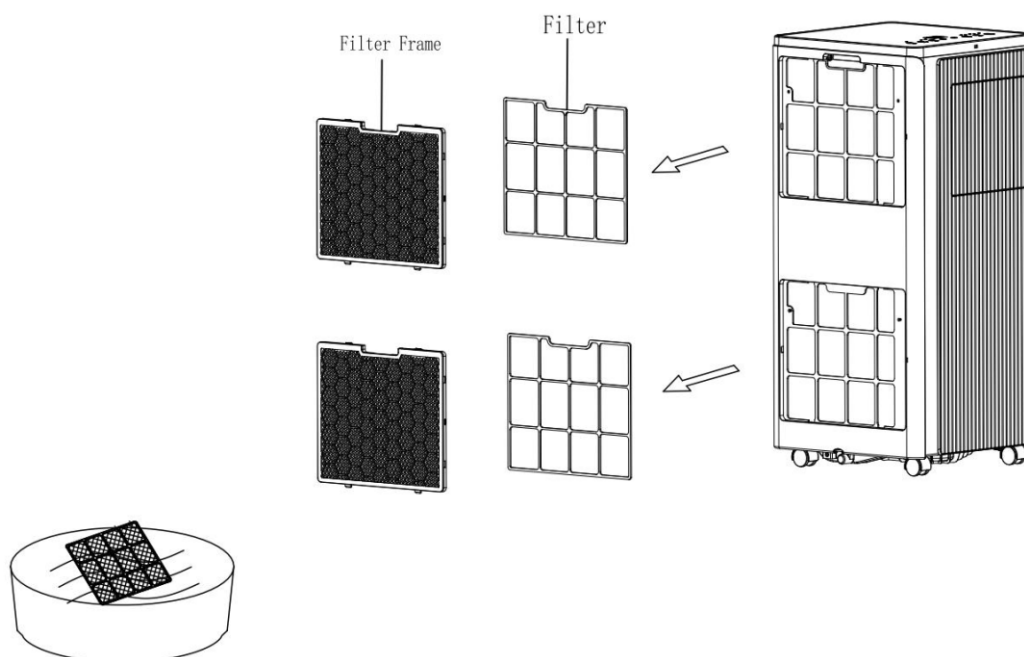

3. Clean the upper filter screen frame

- 1) Unscrew one screw fixed by EVA filter net and back shell with screwdriver, and take out EVA filter net.
- 2) Put the EVA filter screen into warm water with neutral detergent (about 40°C / 104°F) and dry it in the shade after rinsing clean.

VIII. Unit Storage:

- 1: Unscrew the drainage cover, unplug the water plug, and discharge the water in the water pan into other water containers or directly tilt the body to discharge the water into other containers.
- 2: Turn on the machine, adjust it to low-wind ventilation mode, and maintain this state until the drainage pipe becomes dry, so as to keep the inside of the body in a dry state and prevent it from mildewing.
- 3: Turn off the machine, unplug the power plug, and wrap the power cord around the wrapping post; install the water plug and the drainage cover.
- 4: Remove the exhaust pipe and keep it properly.
- 5: Cover the air conditioning with a plastic bag. Put the air conditioning in a dry place, keep it out of the reach of children, and take dust control measures.
- 6: Remove batteries of the remote control and keep them properly.

Note: ensure that the body is placed in a dry place and keep all machine components properly.

IX. Troubleshooting

1. Information on servicing

1) Checks to the area

Prior to beginning work on systems containing flammable refrigerants, safety checks are necessary to ensure that the risk of ignition is minimized. For repair to the refrigerating system, the following precautions shall be complied with prior to conducting work on the system.

2) Work procedure

Work shall be undertaken under a controlled procedure so as to minimize the risk of a flammable gas or vapour being present while the work is being performed.

3) General work area

All maintenance staff and others working in the local area shall be instructed on the nature of work being carried out. Work in confined spaces shall be avoided. The area around the workspace shall be sectioned off. Ensure that the conditions within the area have been made safe by control of flammable material.

4) Checking for presence of refrigerant

The area shall be checked with an appropriate refrigerant detector prior to and during work, to ensure the technician is aware of potentially flammable atmospheres. Ensure that the leak detection equipment being used is suitable for use with flammable refrigerants, i.e. non-sparking, adequately sealed or intrinsically safe.

5) Presence of fire extinguisher

If any hot work is to be conducted on the refrigeration equipment or any associated parts, appropriate fire extinguishing equipment shall be available to hand. Have a dry powder or CO₂ fire extinguisher adjacent to the charging area.

6) No ignition sources

No person carrying out work in relation to a refrigeration system which involves exposing any pipe work that contains or has contained flammable refrigerant shall use any sources of ignition in such a manner that it may lead to the risk of fire or explosion. All possible ignition sources, including cigarette smoking, should be kept sufficiently far away from the site of installation, repairing, removing and disposal, during which flammable refrigerant can possibly be released to the surrounding space. Prior to work taking place, the area around the equipment is to be surveyed to make sure that there are no flammable hazards or ignition risks. "No Smoking" signs shall be displayed.

7) Ventilated area

Ensure that the area is in the open or that it is adequately ventilated before breaking into the system or conducting any hot work. A degree of ventilation shall continue during the period that the work is carried out. The ventilation should safely disperse any released refrigerant and preferably expel it externally into the atmosphere.

8) Checks to the refrigeration equipment

Where electrical components are being changed, they shall be fit for the purpose and to the correct specification. At all times the manufacturer's maintenance and service guidelines shall be followed. If in doubt consult the manufacturer's technical department for assistance.

The following checks shall be applied to installations using flammable refrigerants:

- The charge size is in accordance with the room size within which the refrigerant containing parts are installed;
- The ventilation machinery and outlets are operating adequately and are not obstructed;
- If an indirect refrigerating circuit is being used, the secondary circuit shall be checked for the presence of refrigerant;
- Marking to the equipment continues to be visible and legible. Markings and signs that are illegible shall be corrected;

– Refrigeration pipe or components are installed in a position where they are unlikely to be exposed to any substance which may corrode refrigerant containing components, unless the components are constructed of materials which are inherently resistant to being corroded or are suitably protected against being so corroded.

9) Checks to electrical devices

Repair and maintenance to electrical components shall include initial safety checks and component inspection procedures. If a fault exists that could compromise safety, then no electrical supply shall be connected to the circuit until it is satisfactorily dealt with. If the fault cannot be corrected immediately but it is necessary to continue operation, an adequate temporary solution shall be used. This shall be reported to the owner of the equipment so all parties are advised.

Initial safety checks shall include:

- That capacitors are discharged: this shall be done in a safe manner to avoid possibility of sparking;
- That there no live electrical components and wiring are exposed while charging, recovering or purging the system;
- That there is continuity of earth bonding.

2. Repairs to sealed components

1) During repairs to sealed components, all electrical supplies shall be disconnected from the equipment being worked upon prior to any removal of sealed covers, etc. If it is absolutely necessary to have an electrical supply to equipment during servicing, then a permanently operating form of leak detection shall be located at the most critical point to warn of a potentially hazardous situation.

2) Particular attention shall be paid to the following to ensure that by working on electrical components, the casing is not altered in such a way that the level of protection is affected.

This shall include damage to cables, excessive number of connections, terminals not made to original specification, damage to seals, incorrect fitting of glands, etc.

Ensure that apparatus is mounted securely.

Ensure that seals or sealing materials have not degraded such that they no longer serve the purpose of preventing the ingress of flammable atmospheres. Replacement parts shall be in accordance with the manufacturer's specifications.

NOTE: The use of silicon sealant may inhibit the effectiveness of some types of leak detection equipment. Intrinsically safe components do not have to be isolated prior to working on them.

3. Repair to intrinsically safe components

Do not apply any permanent inductive or capacitance loads to the circuit without ensuring that this will not exceed the permissible voltage and current permitted for the equipment in use.

Intrinsically safe components are the only types that can be worked on while live in the presence of a flammable atmosphere. The test apparatus shall be at the correct rating.

Replace components only with parts specified by the manufacturer. Other parts may result in the ignition of refrigerant in the atmosphere from a leak.

4. Cabling

Check that cabling will not be subject to wear, corrosion, excessive pressure, vibration, sharp edges or any other adverse environmental effects. The check shall also take into account the effects of aging or continual vibration from sources such as compressors or fans.

5. Detection of flammable refrigerants

Under no circumstances shall potential sources of ignition be used in the searching for or detection of refrigerant leaks. A halide torch (or any other detector using a naked flame) shall not be used.

6. Leak detection methods

The following leak detection methods are deemed acceptable for systems containing flammable refrigerants.

Electronic leak detectors shall be used to detect flammable refrigerants, but the sensitivity may not be adequate, or may need re-calibration. (Detection equipment shall be calibrated in a refrigerant-free area.) Ensure that the detector is not a potential source of ignition and is suitable for the refrigerant used. Leak detection equipment shall be set at a percentage of the LFL of the refrigerant and shall be calibrated to the refrigerant employed and the appropriate percentage of gas (25 % maximum) is confirmed.

Leak detection fluids are suitable for use with most refrigerants but the use of detergents containing chlorine shall be avoided as the chlorine may react with the refrigerant and corrode the copper pipe-work.

If a leak is suspected, all naked flames shall be removed/ extinguished.

If a leakage of refrigerant is found which requires brazing, all of the refrigerant shall be recovered from the system, or isolated (by means of shut off valves) in a part of the system remote from the leak. Oxygen free nitrogen (OFN) shall then be purged through the system both before and during the brazing process.

7. Removal and evacuation

When breaking into the refrigerant circuit to make repairs – or for any other purpose conventional procedures shall be used. However, it is important that best practice is followed since flammability is a consideration. The following procedure shall be adhered to:

- Remove refrigerant;
- Purge the circuit with inert gas;
- Evacuate;
- Purge again with inert gas;
- Open the circuit by cutting or brazing.

The refrigerant charge shall be recovered into the correct recovery cylinders. The system shall be “flushed” with OFN to render the unit safe. This process may need to be repeated several times. Compressed air or oxygen shall not be used for this task.

Flushing shall be achieved by breaking the vacuum in the system with OFN and continuing to fill until the working pressure is achieved, then venting to atmosphere, and finally pulling down to a vacuum. This process shall be repeated until no refrigerant is within the system. When the final OFN charge is used, the system shall be vented down to atmospheric pressure to enable work to take place. This operation is absolutely vital if brazing operations on the pipe-work are to take place.

Ensure that the outlet for the vacuum pump is not close to any ignition sources and there is ventilation available.

8. Charging procedures

In addition to conventional charging procedures, the following requirements shall be followed.

- Ensure that contamination of different refrigerants does not occur when using charging equipment. Hoses or lines shall be as short as possible to minimize the amount of refrigerant contained in them.

- Cylinders shall be kept upright.
- Ensure that the refrigeration system is earthed prior to charging the system with refrigerant.
- Label the system when charging is complete (if not already).
- Extreme care shall be taken not to overfill the refrigeration system.

Prior to recharging the system it shall be pressure tested with OFN. The system shall be leak tested on completion of charging but prior to commissioning. A follow up leak test shall be carried out prior to leaving the site.

9. Decommissioning

Before carrying out this procedure, it is essential that the technician is completely familiar with the equipment and all its detail. It is recommended good practice that all refrigerants are recovered safely. Prior to the task being carried out, an oil and refrigerant sample shall be taken in case analysis is required prior to re-use of reclaimed refrigerant. It is essential that electrical power is available before the task is commenced.

- a) Become familiar with the equipment and its operation.
- b) Isolate system electrically.
- c) Before attempting the procedure ensure that:
 - Mechanical handling equipment is available, if required, for handling refrigerant cylinders;
 - All personal protective equipment is available and being used correctly;
 - The recovery process is supervised at all times by a competent person;
 - Recovery equipment and cylinders conform to the appropriate standards.
- d) Pump down refrigerant system, if possible.
- e) If a vacuum is not possible, make a manifold so that refrigerant can be removed from various parts of the system.
- f) Make sure that cylinder is situated on the scales before recovery takes place.
- g) Start the recovery machine and operate in accordance with manufacturer's instructions.
- h) Do not overfill cylinders. (No more than 80 % volume liquid charge).
- i) Do not exceed the maximum working pressure of the cylinder, even temporarily.
- j) When the cylinders have been filled correctly and the process completed, make sure that the cylinders and the equipment are removed from site promptly and all isolation valves on the equipment are closed off.
- k) Recovered refrigerant shall not be charged into another refrigeration system unless it has been cleaned and checked.

10. Labeling

Equipment shall be labelled stating that it has been de-commissioned and emptied of refrigerant. The label shall be dated and signed. Ensure that there are labels on the equipment stating the equipment contains flammable refrigerant.

11. Recovery

When removing refrigerant from a system, either for servicing or decommissioning, it is recommended good practice that all refrigerants are removed safely.

When transferring refrigerant into cylinders, ensure that only appropriate refrigerant recovery cylinders are employed. Ensure that the correct number of cylinders for holding the total system charge is available. All cylinders to be used are designated for the

recovered refrigerant and labelled for that refrigerant (i.e. special cylinders for the recovery of refrigerant). Cylinders shall be complete with pressure relief valve and associated shut-off valves in good working order. Empty recovery cylinders are evacuated and, if possible, cooled before recovery occurs.

The recovery equipment shall be in good working order with a set of instructions concerning the equipment that is at hand and shall be suitable for the recovery of flammable refrigerants. In addition, a set of calibrated weighing scales shall be available and in good working order. Hoses shall be complete with leak-free disconnect couplings and in good condition. Before using the recovery machine, check that it is in satisfactory working order, has been properly maintained and that any associated electrical components are sealed to prevent ignition in the event of a refrigerant release. Consult manufacturer if in doubt.

The recovered refrigerant shall be returned to the refrigerant supplier in the correct recovery cylinder, and the relevant Waste Transfer Note arranged. Do not mix refrigerants in recovery units and especially not in cylinders.

If compressors or compressor oils are to be removed, ensure that they have been evacuated to an acceptable level to make certain that flammable refrigerant does not remain within the lubricant. The evacuation process shall be carried out prior to returning the compressor to the suppliers. Only electric heating to the compressor body shall be employed to accelerate this process. When oil is drained from a system, it shall be carried out safely.

Fuse parameters of the machine

Type: 5H,5N,5ET or 932

Voltage: 250V

Current: 3.15 A

A. Unit Storage:

- 1: Unscrew the drainage cover, unplug the water plug, and discharge the water in the water pan into other water containers or directly tilt the body to discharge the water into other containers.
- 2: Turn on the machine, adjust it to low-wind ventilation mode, and maintain this state until the drainage pipe becomes dry, so as to keep the inside of the body in a dry state and prevent it from mildewing.
- 3: Turn off the machine, unplug the power plug, and wrap the power cord around the wrapping post; install the water plug and the drainage cover.
- 4: Remove the exhaust pipe and keep it properly.
- 5: Cover the air conditioning with a plastic bag. Put the air conditioning in a dry place, keep it out of the reach of children, and take dust control measures.
- 6: Remove batteries of the remote control and keep them properly.

Note: Ensure that the body is placed in a dry place and keep all machine components properly.

IX. Troubleshooting

Do not repair or disassemble the air conditioning by yourself. Unqualified repair will lead to failure of the warranty card, and may cause damage to users or their properties.

Problems	Reasons	Solutions
The air conditioning does not work.	There is no electricity.	Turn it on after connecting it to a socket with electricity.
	The overflow indicator displays "FL".	Discharge the water inside.
	The ambient temperature is too low or too high	Recommend to use the machine in at the temperature of 7-35°C (44-95°F).
	In cooling mode, the room temperature is lower than the set temperature; in heating mode, the room temperature is higher than the set temperature.	Change the set temperature.
	In dehumidification mode, the ambient temperature is low.	The machine is placed in a room with an ambient temperature of greater than 17 °C (62°F).
The cooling effect is not good	There is direct sunlight.	Pull the Curtain.
	Doors or windows are open; there are a lot of people; or in cooling mode, there are other sources of heat.	Close doors and windows, and add new air conditioning.
	The filter screen is dirty.	Clean or replace the filter screen.
	The air inlet or outlet is blocked.	Clear obstructions.
Big noise	The air conditioning is not placed on a flat surface.	Put the air conditioning on a flat and hard place (to reduce noise).
Compressor does not work	Overheat protection starts	Wait for 3 minutes until the temperature is lowered, and then restart the machine
The remote control does not work	The distance between the machine and the remote control is too far.	Let the remote control get close to the air conditioning, and make sure that the remote control directly faces to the direction of the remote control receiver.
	The remote control is not aligned with the direction of the remote control receiver.	
	Batteries are dead.	Replace batteries.
Displays 'E1'	The pipe temperature sensor is abnormal.	Check the pipe temperature sensor and related circuitry.
Displays 'E2'	The pipe temperature sensor is abnormal.	Check the pipe temperature sensor and related circuitry.

Note: If problems not listed in the table occur or recommended solutions do not work, please contact the professional service organization.

X. Addendum

Schematic diagram for air conditioning

(The specific technical parameters of the machine shall be subject to the nameplate on the product).

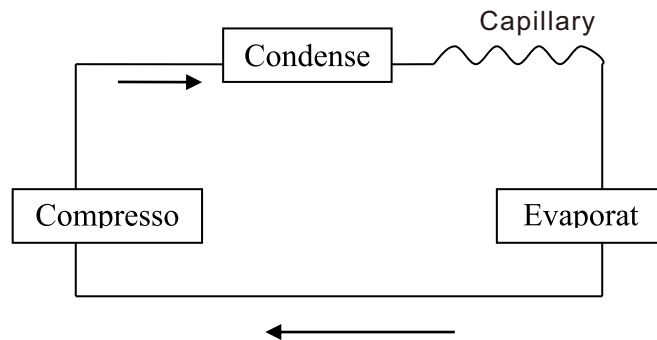

Treatment: Don't put the abandoned machine with other unsorted waste together. Such waste shall be placed separately for other special use.

If you have any questions, please contact our customer care centre.
Our contact details are below:



0044-800-240-4004



enquiries@mhstar.co.uk

IMPORTER ADDRESS:
MH STAR UK LTD
Unit 27, Perivale Park,
Horsenden lane South
Perivale, UB6 7RH
MADE IN CHINA

