

PawHut!

IN231100124V01_GL

D51-130V01

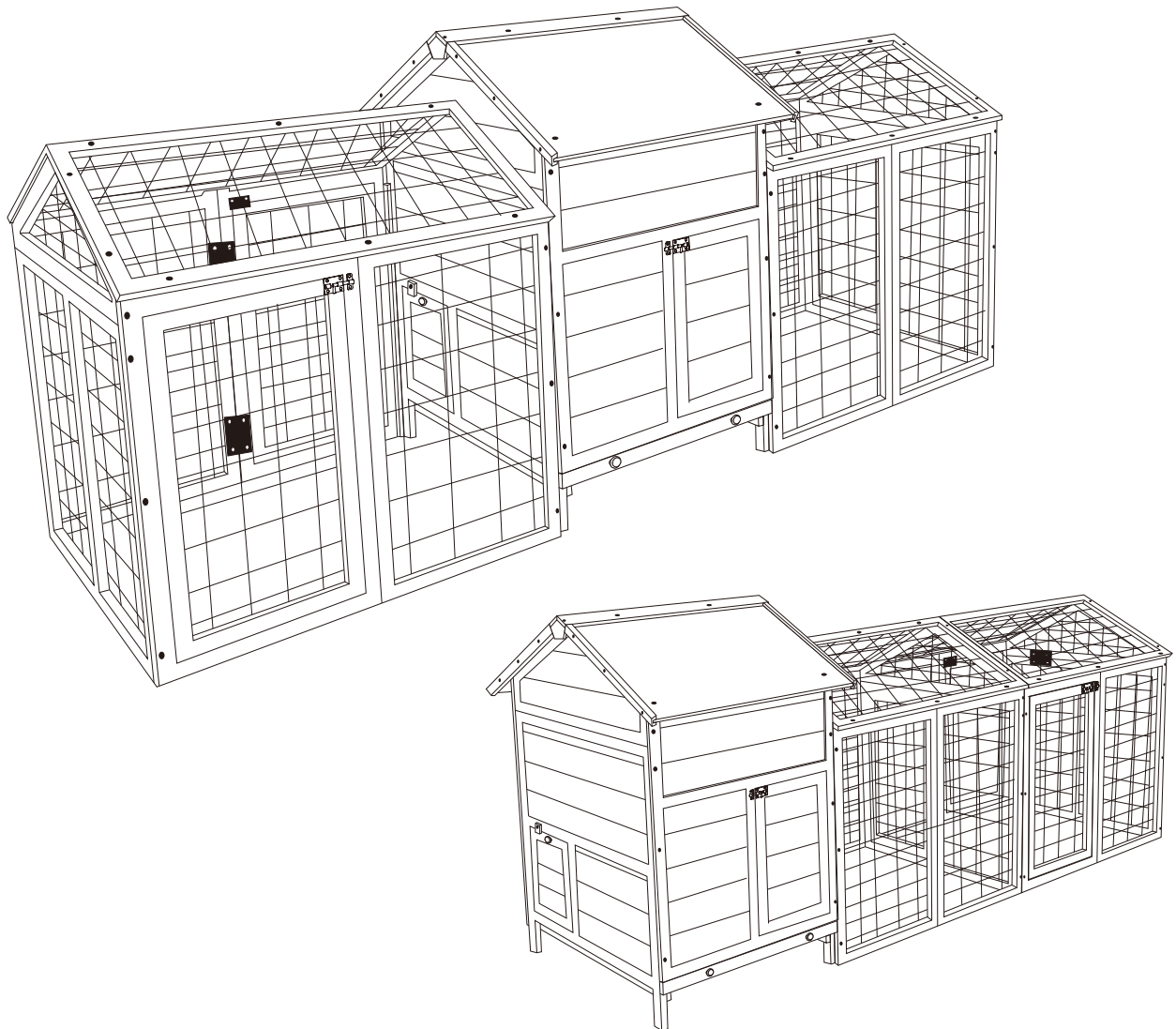

EN_IMPORTANT, RETAIN FOR FUTURE REFERENCE: READ CAREFULLY.



**FR_IMPORTANT: A LIRE ATTENTIVEMENT ET À CONSERVER POUR CONSULTATION
ULTÉRIEURE.**







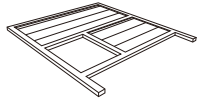
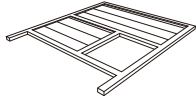
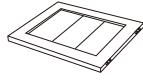
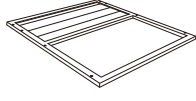
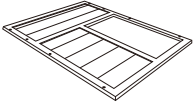
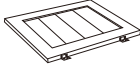

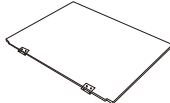
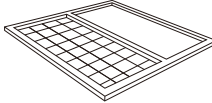
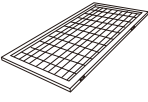
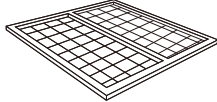
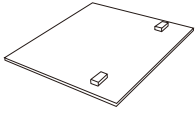

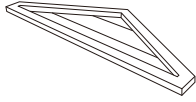

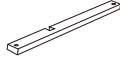

ES_IMPORTANTE, LEA Y GUARDE PARA FUTURAS REFERENCIAS.

PT_IMPORTANTE, RETER PARA REFERÊNCIA FUTURA: LEIA ATENTAMENTE.

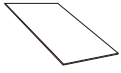
DE_WICHTIG! SORFGFÄLTIG LESEN UND FÜR SPÄTERES NACHSCHLAGEN AUFBEWAHREN.

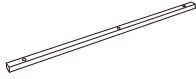
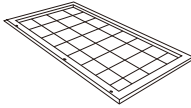
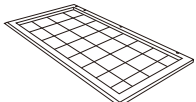
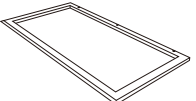
**IT_IMPORTANTE! CONSERVARE IL PRESENTE MANUALE PER FUTURO RIFERIMENTO E
LEggerlo ATTENTAMENTE.**

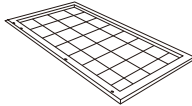
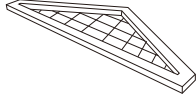
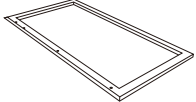
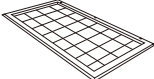
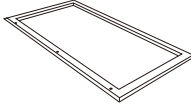
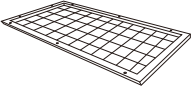
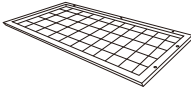
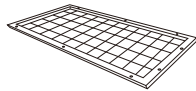
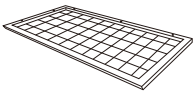
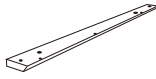
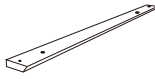
<p>BOX 1-2</p>	 A	 B	 C*2	 H
 I	 J	 L	 R	 AA
 AB	 AF	 AK*2		

<p>BOX 2-2</p>	 D*2	 E	 F	 G*2
 K	 M	 N	 O	 P
 Q	 S*2	 T*4	 U	 V*2
 W	 X*3	 Y	 Z*2	 AC
 AD	 AE	 AG	 AH	 AI
 AJ	 AL	 AM	 AN*2	 AO*4



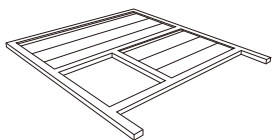

A

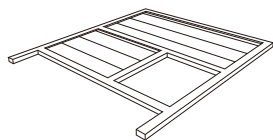

B

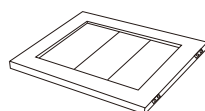

C*2

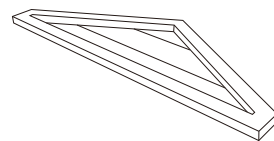

D*2

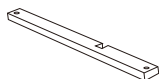

E

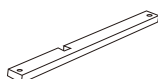

F

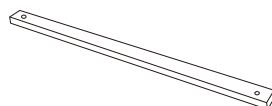

G*2

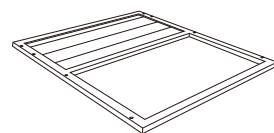

H

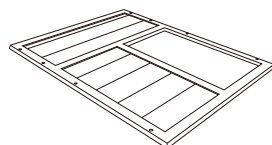

I

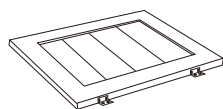

J



K



L

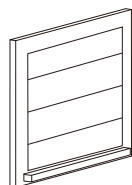

M

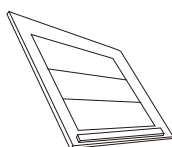

N

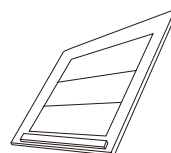

O

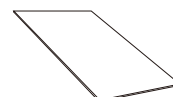

P



Q

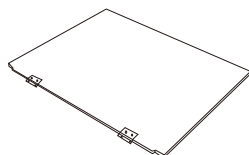

R

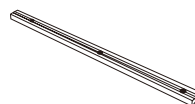

S*2

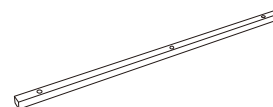

T*4

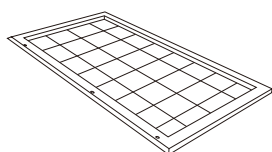

U

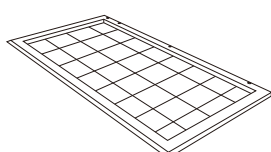

V*2

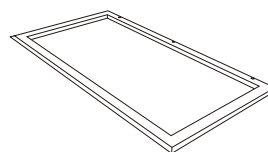

W

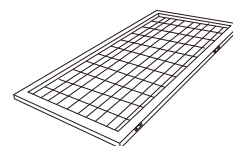

X*3

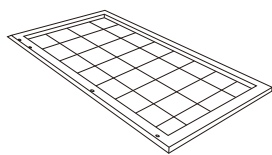

Y

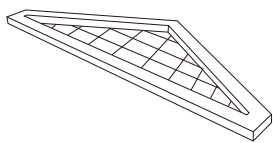

Z*2

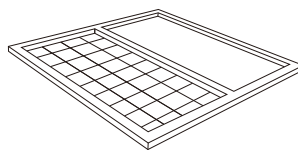

AA

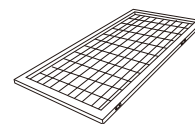

AB

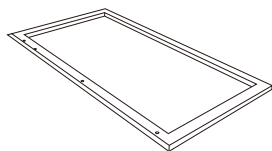

AC

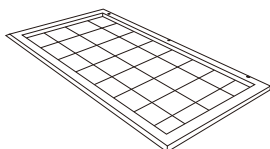

AD

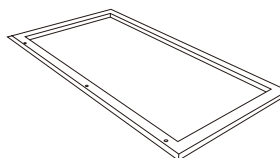

AE

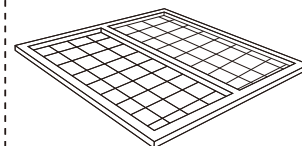

AF

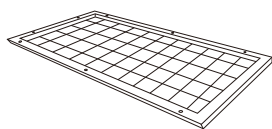

AG

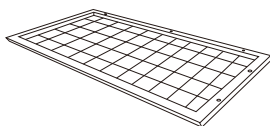

AH

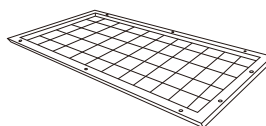

AI

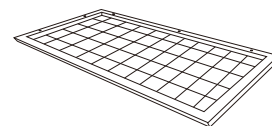

AJ

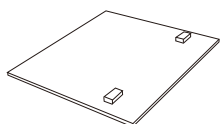

AK*2

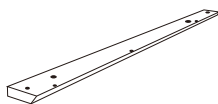

AL

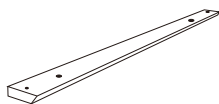

AM



AN*2

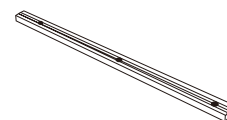

AO*4



3.5*30mm 102+10pcs

S1



3.5*25mm 5pcs

S2



3.5*20 mm 6pcs

S3



3.0*18 mm 25+2pcs

S4



3.0*15 mm 64+6pcs

S5



3.0*8 mm 4pcs

S6



2.5*10 mm 72+7pcs

S7



7pcs

S8



2pcs

S9



4pcs

S10



16pcs

S11



5pcs

S12

- A** x01
- C** x01
- S8** x01
- S9** x01
- S10** x01
- S3** x01
- 3.5*20mm
- S7** x06
- 2.5*10mm

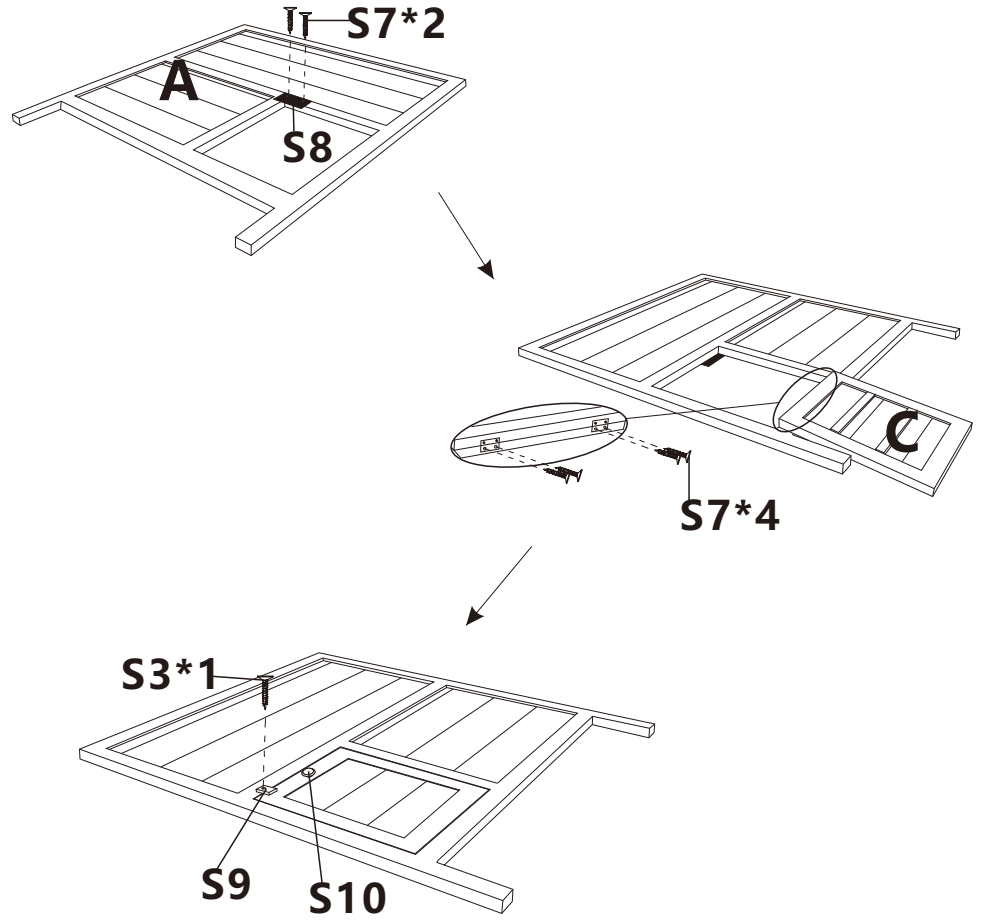

- 01**
- D** x01
- E** x01
- G** x01
- S11** x02
- S1** x04
- 3.5*30mm
- S5** x08
- 3.0*15mm

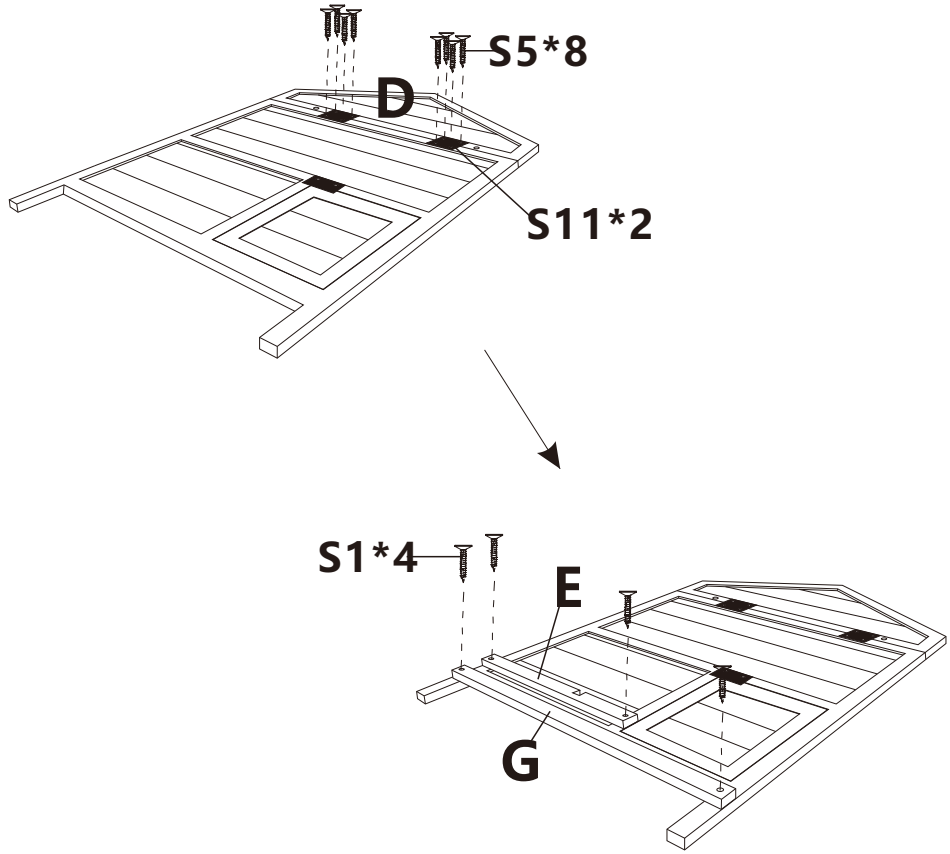

- B** x01
- C** x01
- S8** x01
- S9** x01
- S10** x01
- S3** x01
- 3.5*20mm
- S7** x06
- 2.5*10mm

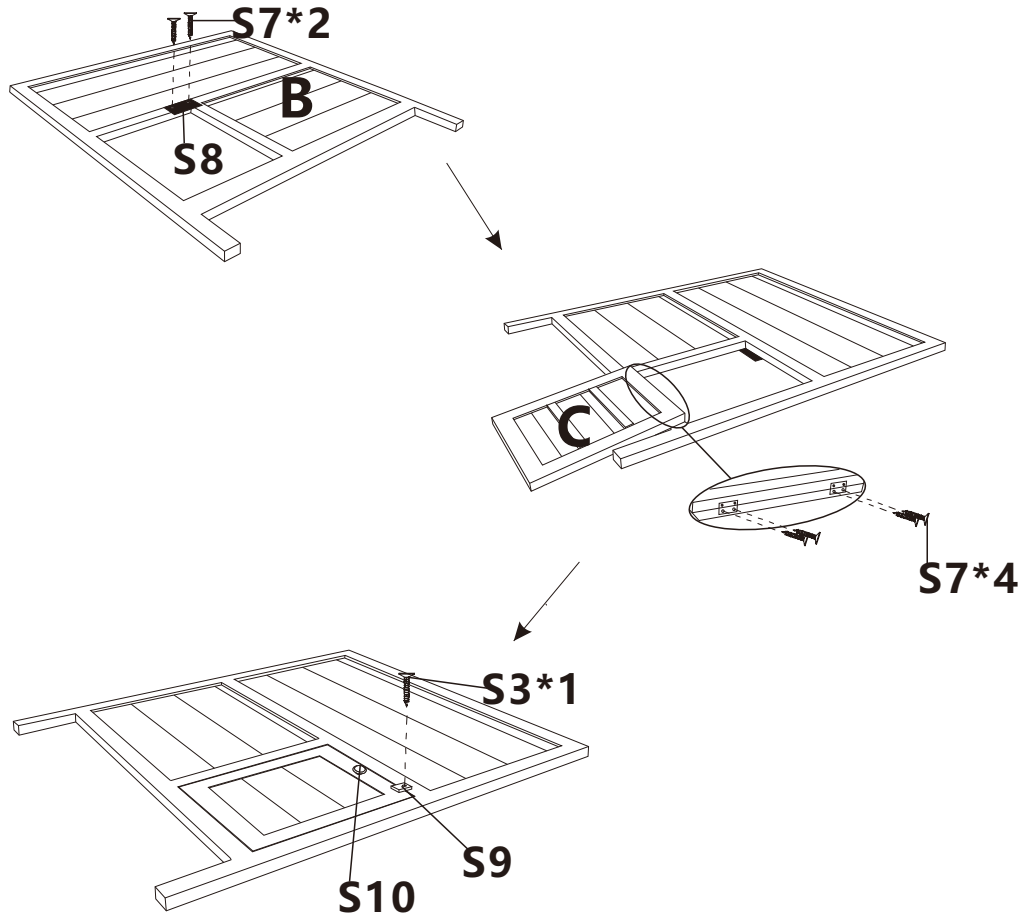

- 03**
- D** x01
- F** x01
- G** x01
- S11** x02
- S1** x04
- 3.5*30mm
- S5** x08
- 3.0*15mm

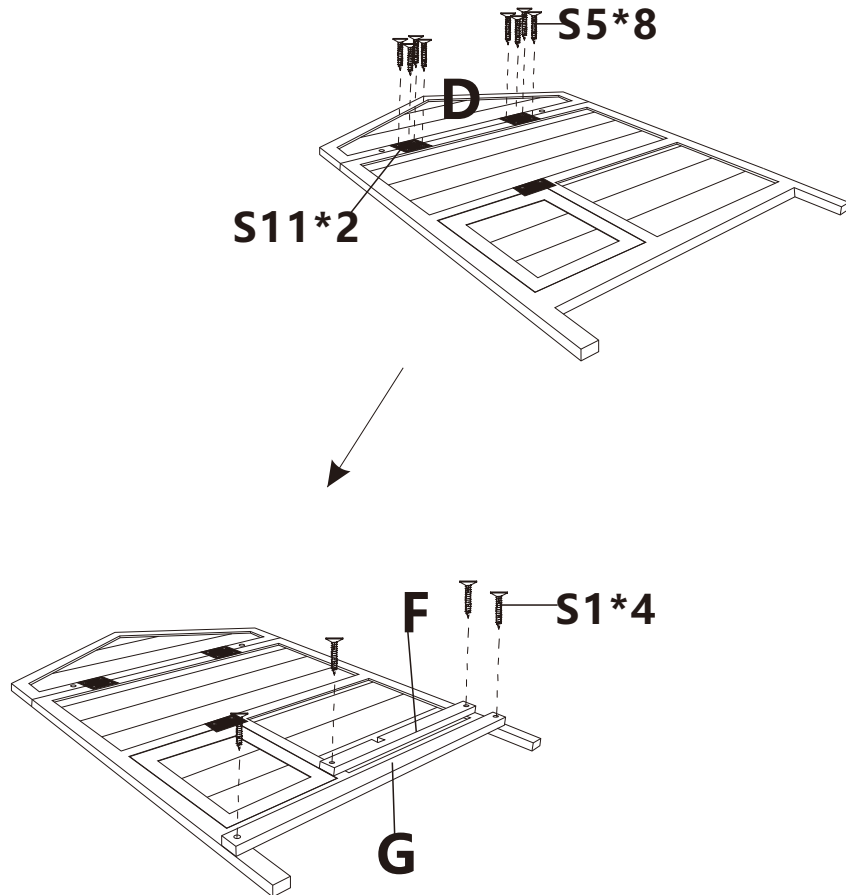

02

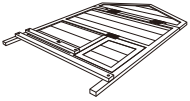

04

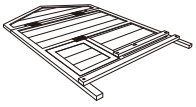

H x01

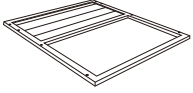

S1 x08



3.5*30mm

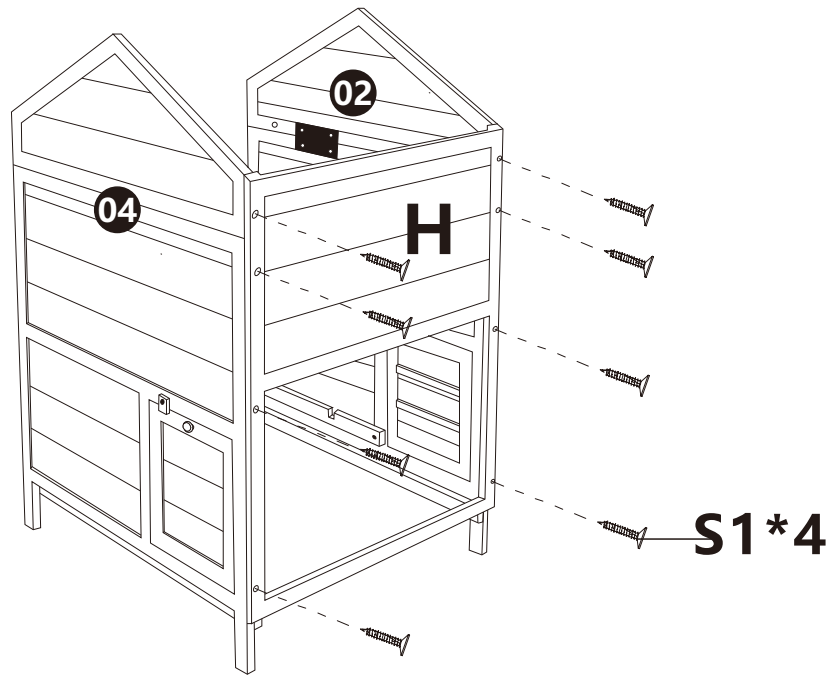

05



K x01

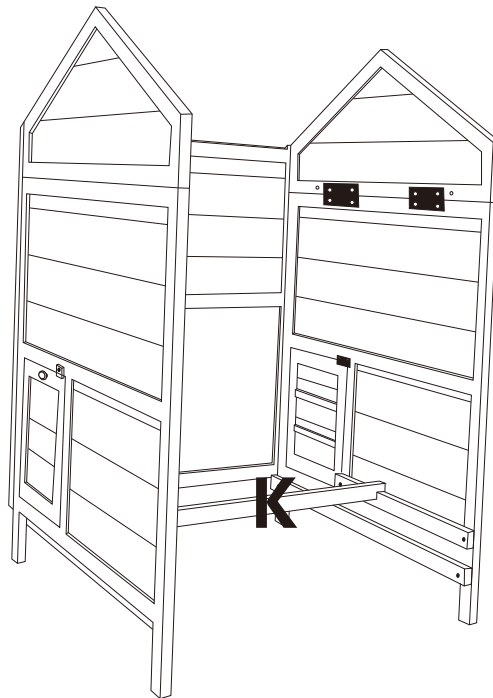

- I** x01
- J** x01
- S8** x01
- S12** x01
- S7** x12
- 2.5*10mm

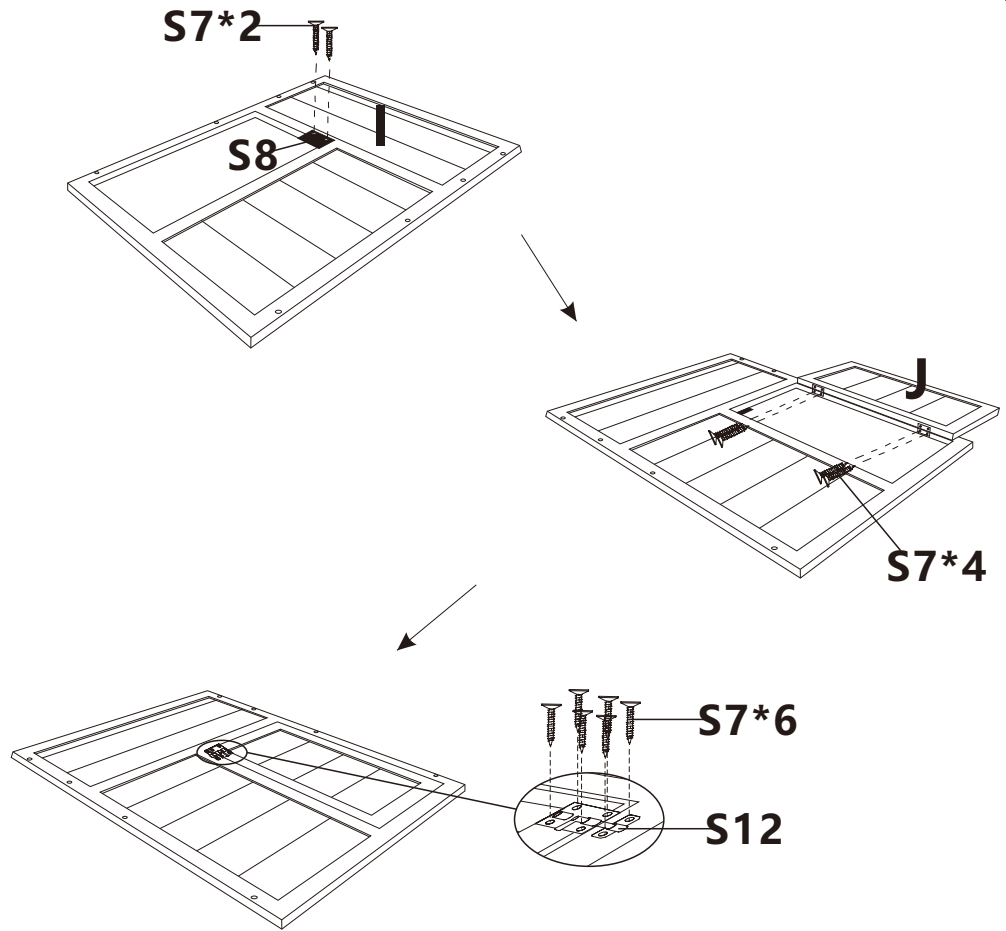

- 06**
- 07**
- S1** x08
- 3.5*30mm

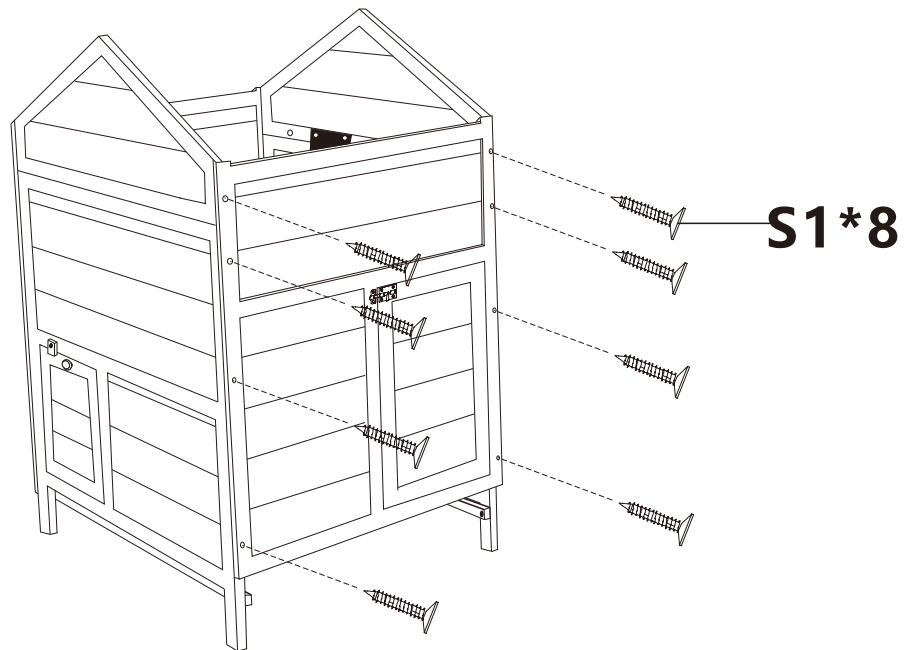

08



L x01



S10 x02

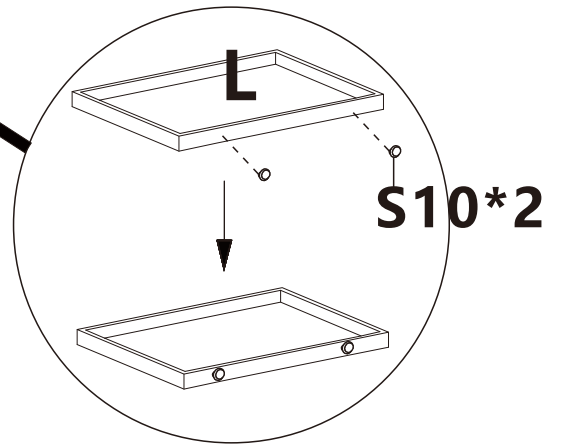
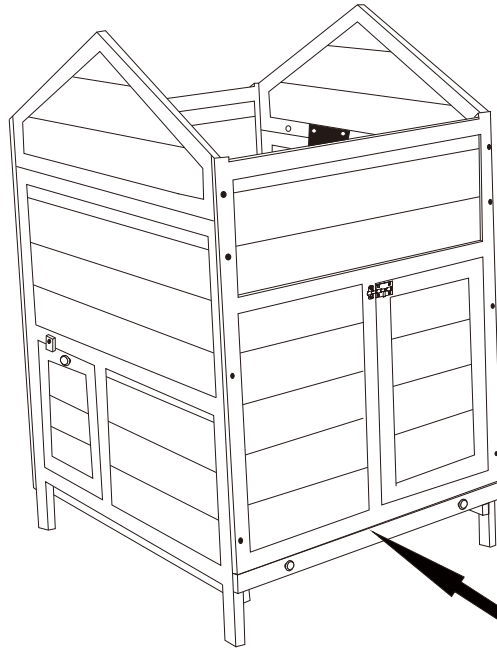

M x01



N x01



O x01



P x01



Q x01



S1 x04



3.5*30mm

S2 x01



3.5*25mm

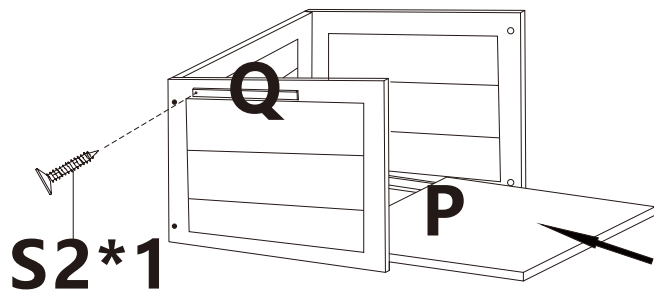
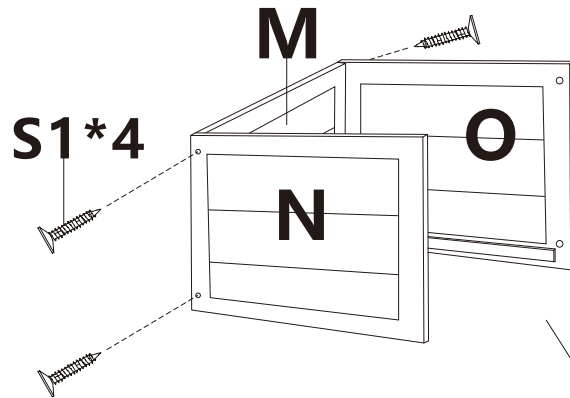

09



10

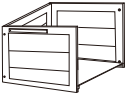

S1 x04



3.5*30mm

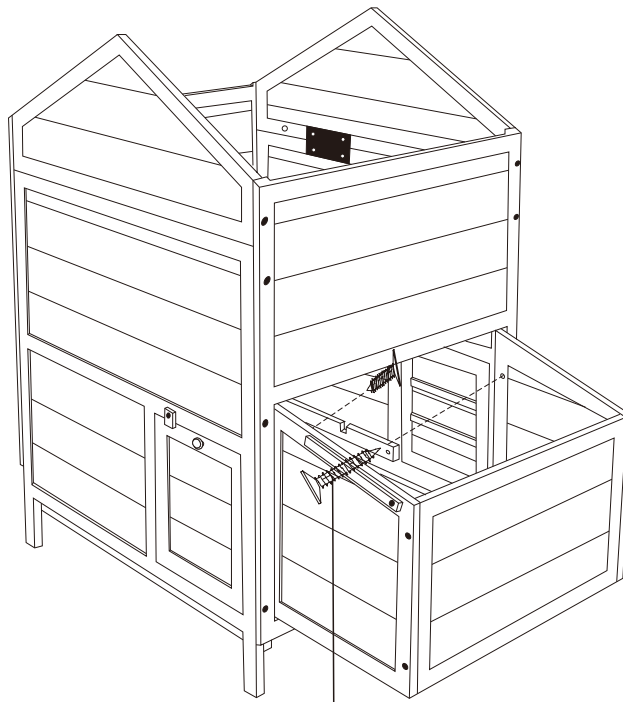

S1*4

11



R x01

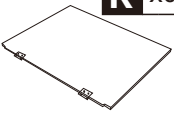

S6 x04



3.0*8mm

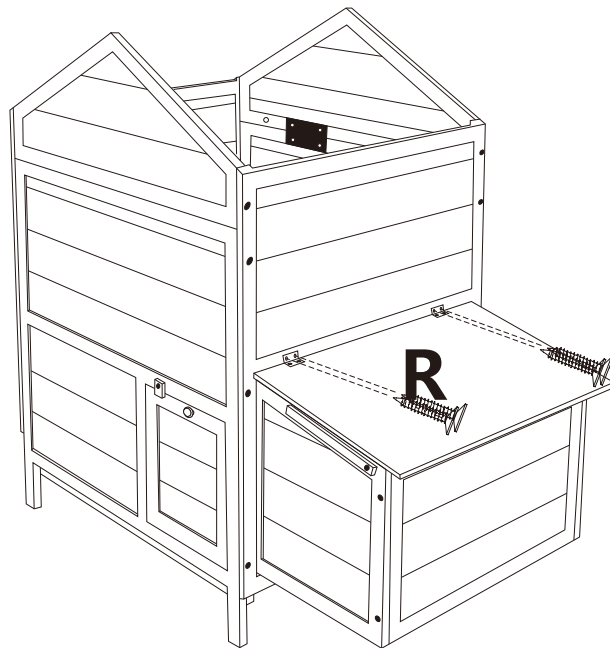

S6*4

12



S x02



S4 x06



3.0*18mm

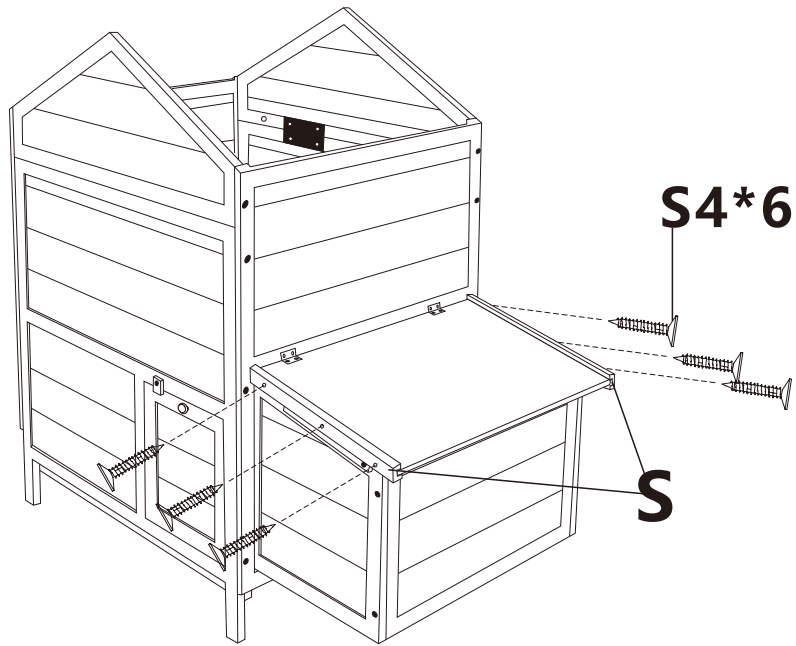

S4*6

S

13



T x02

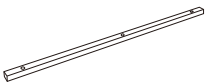

S1 x06



3.5*30mm

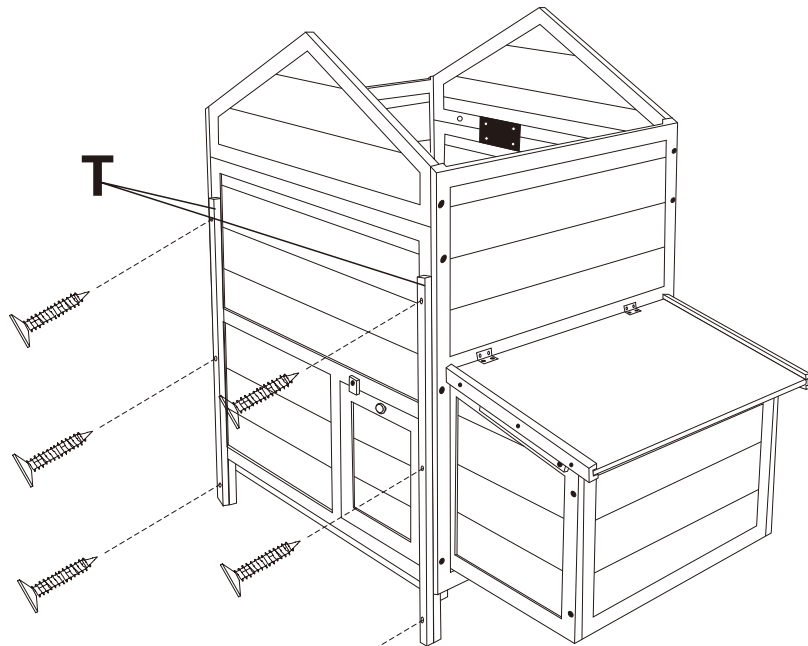

T

S1*6

U x01

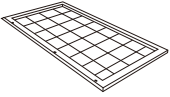

V x01

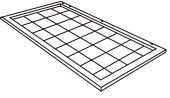

S11 x02



S5 x08



3.0*18mm

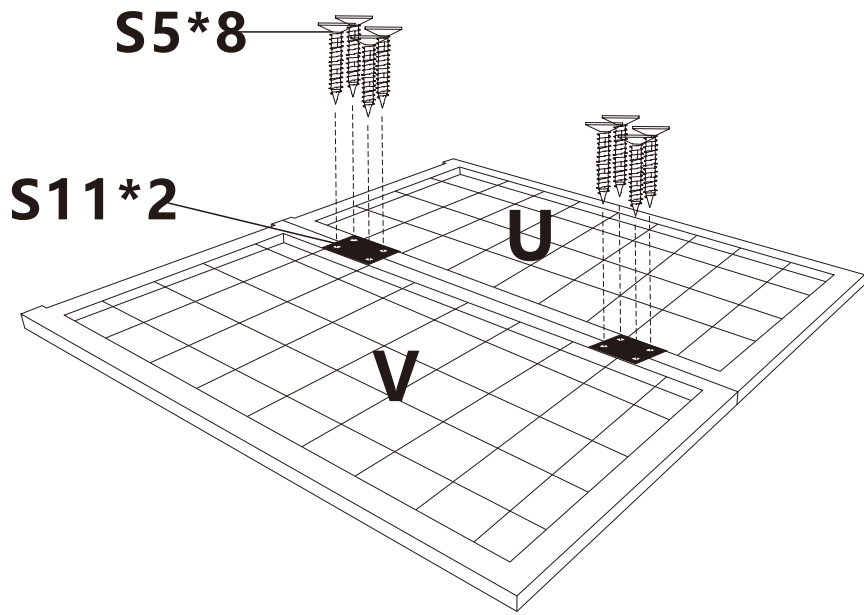

W x01

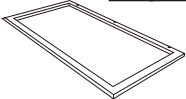

X x01

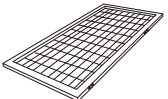

S8 x01



S12 x01



S7 x12



2.5*10mm

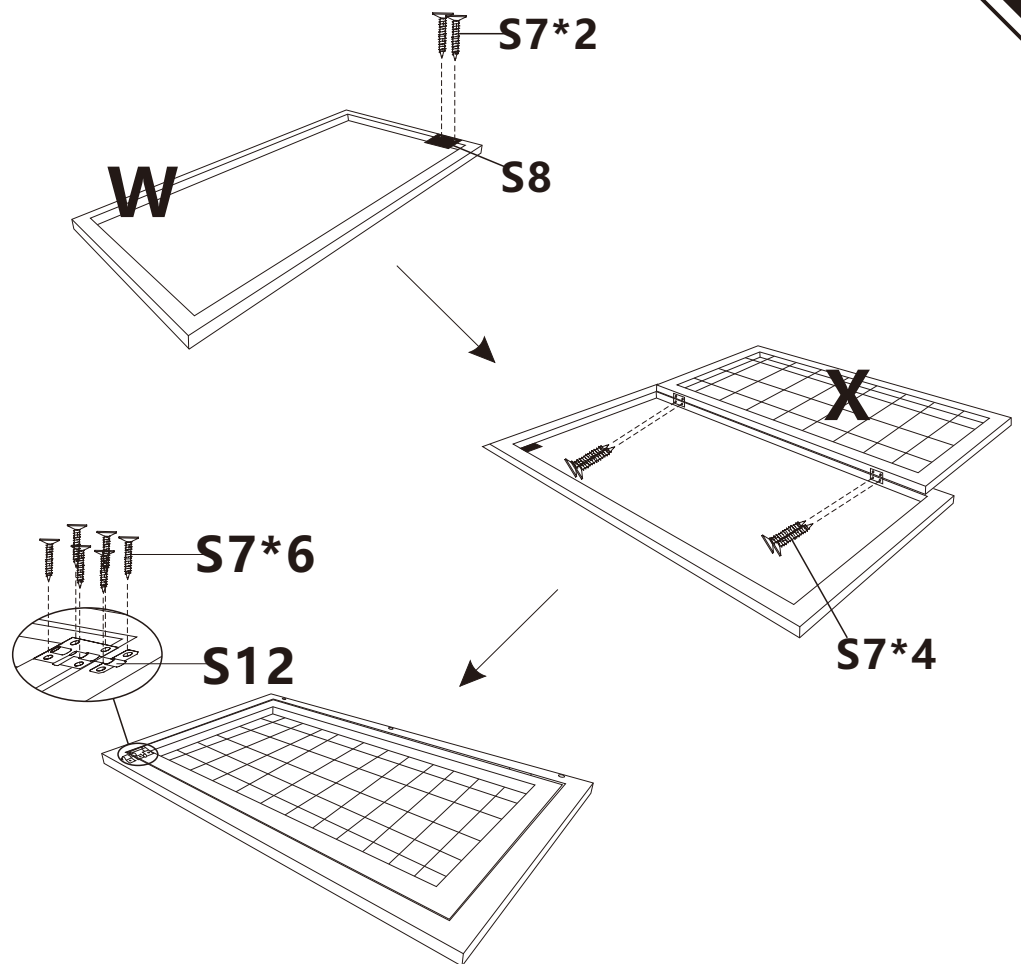

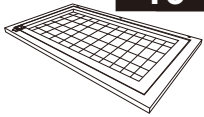

16

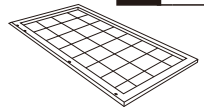

Y x01



S11 x02

S5 x08



3.0*18mm

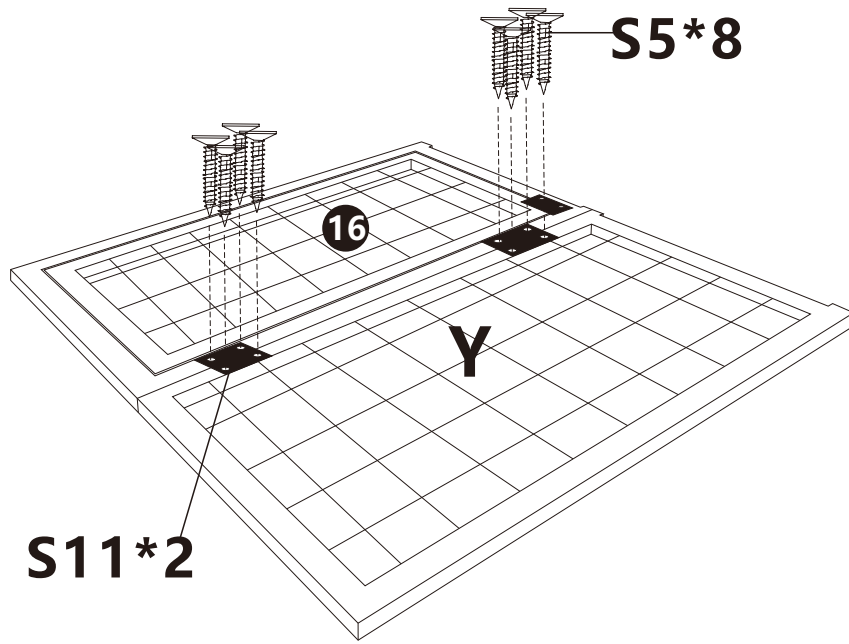

S11*2

S5*8



Z x01

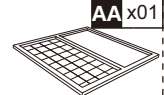

AA x01

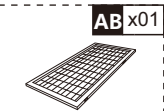

AB x01



S8 x01

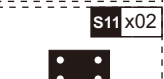

S11 x02

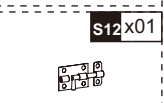

S12 x01



S5 x08

3.0*15mm



S7 x12

2.5*10mm

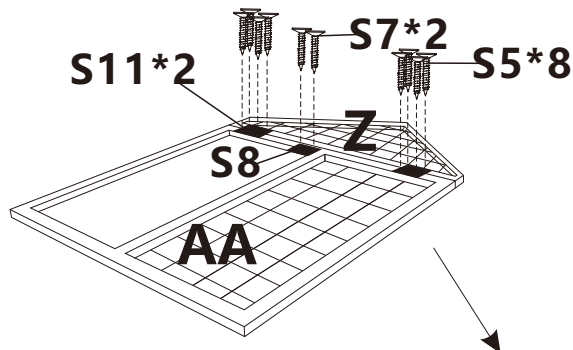

S11*2

S7*2

S5*8

S8

AA

Z

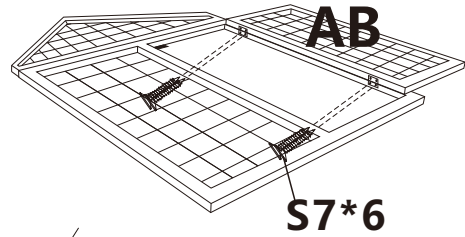

AB

S7*6

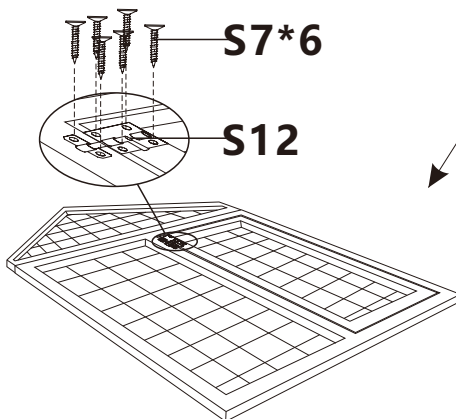

S7*6

S12

15

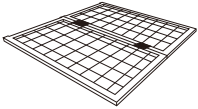

17

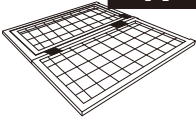

18

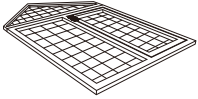

S1x08



3.5*30mm

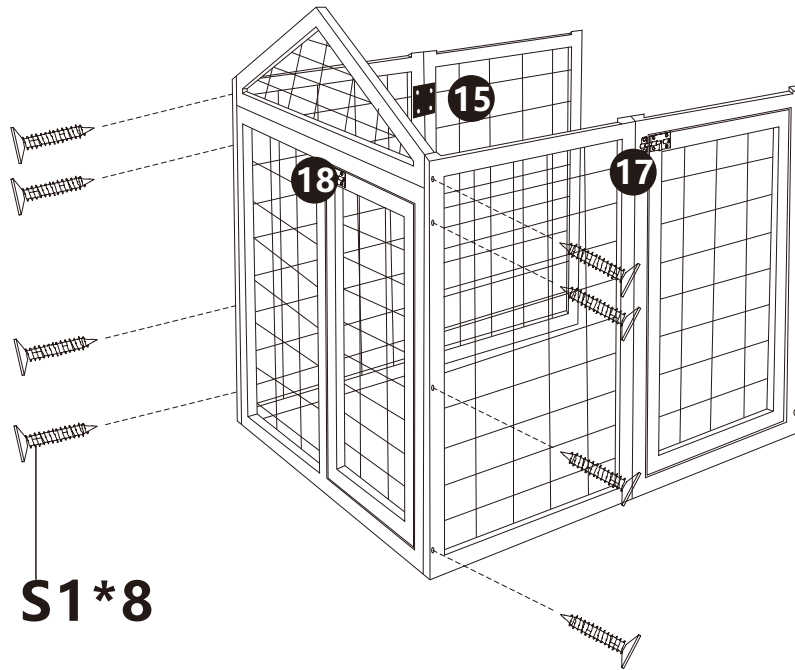

14



19



S1x06



3.5*30mm

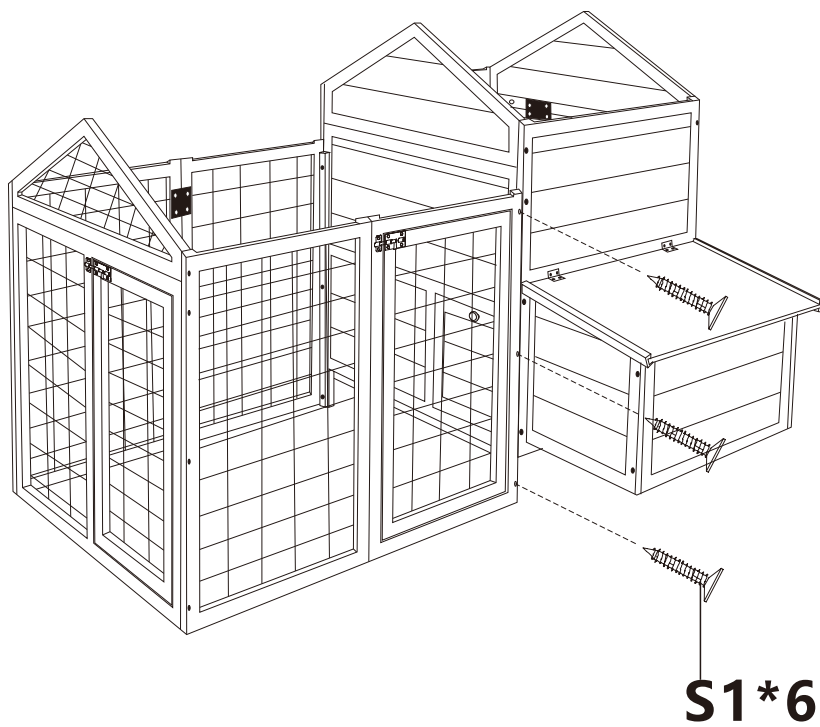

20



AG x01

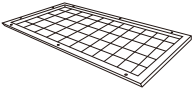

AH x01

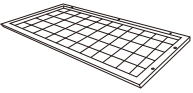

S1 x15



3.5*30mm

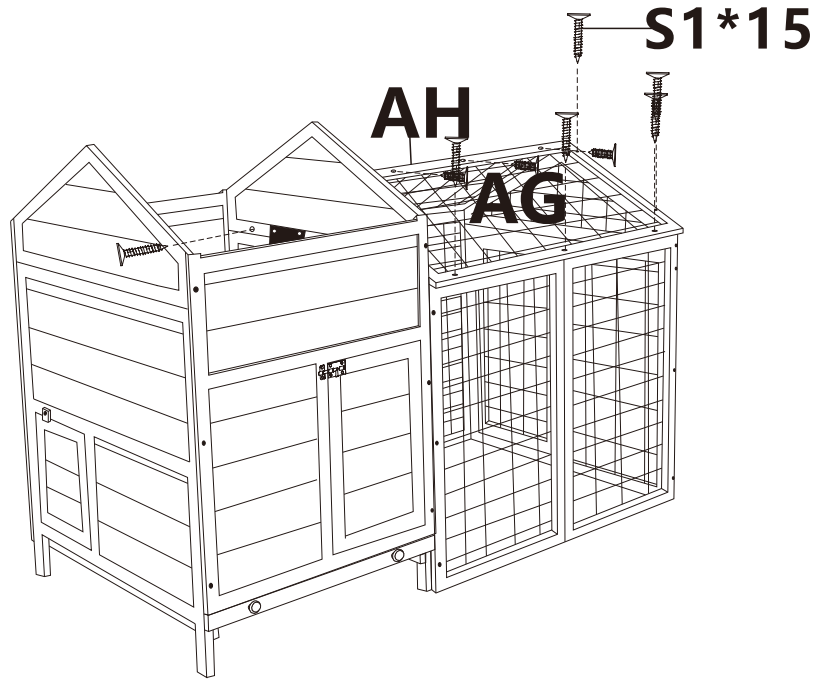

AC x01

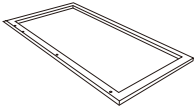

X x01

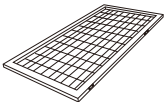

S8 x01



S12 x01



S7 x12



2.5*10mm

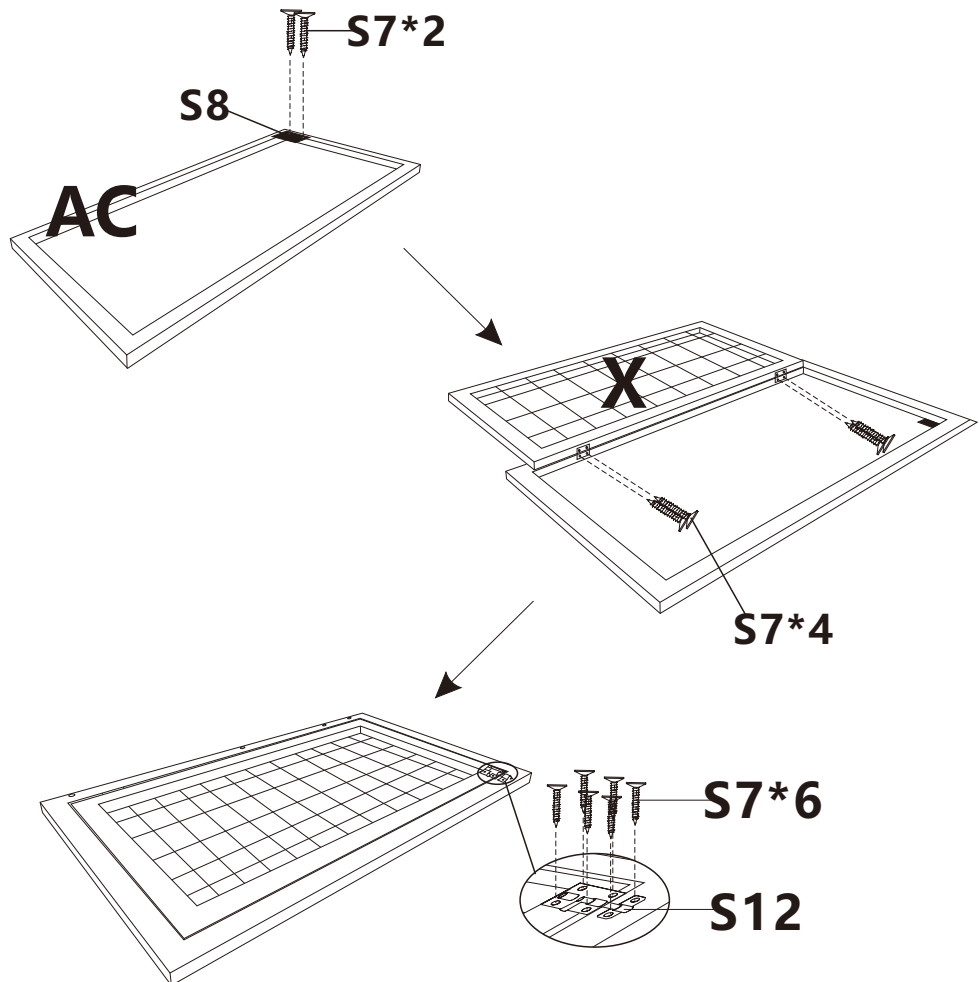

22

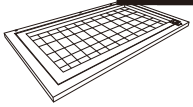

AD x01

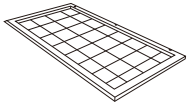

S11 x02



S5 x08



3.0*15mm

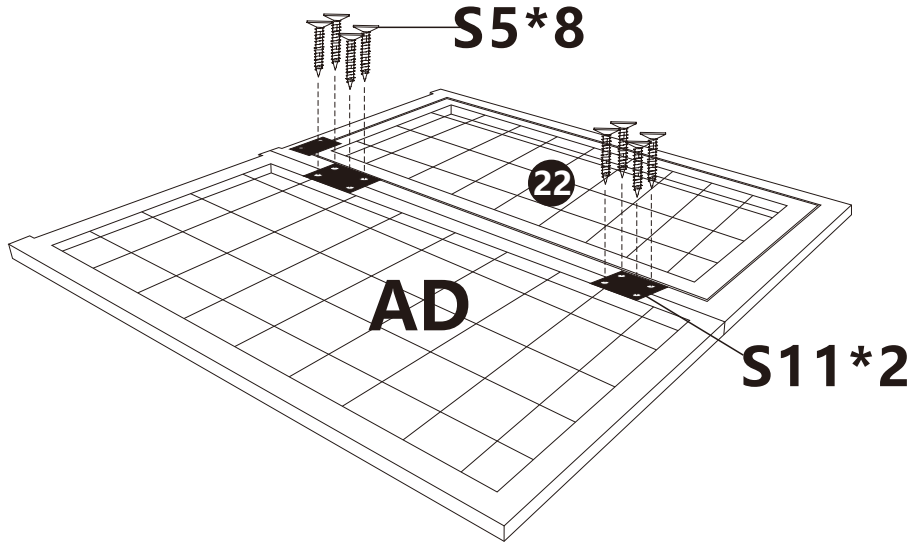

AE x01

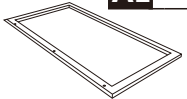

X x01

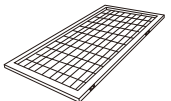

S8 x01



S12 x01



S7 x12



2.5*10mm

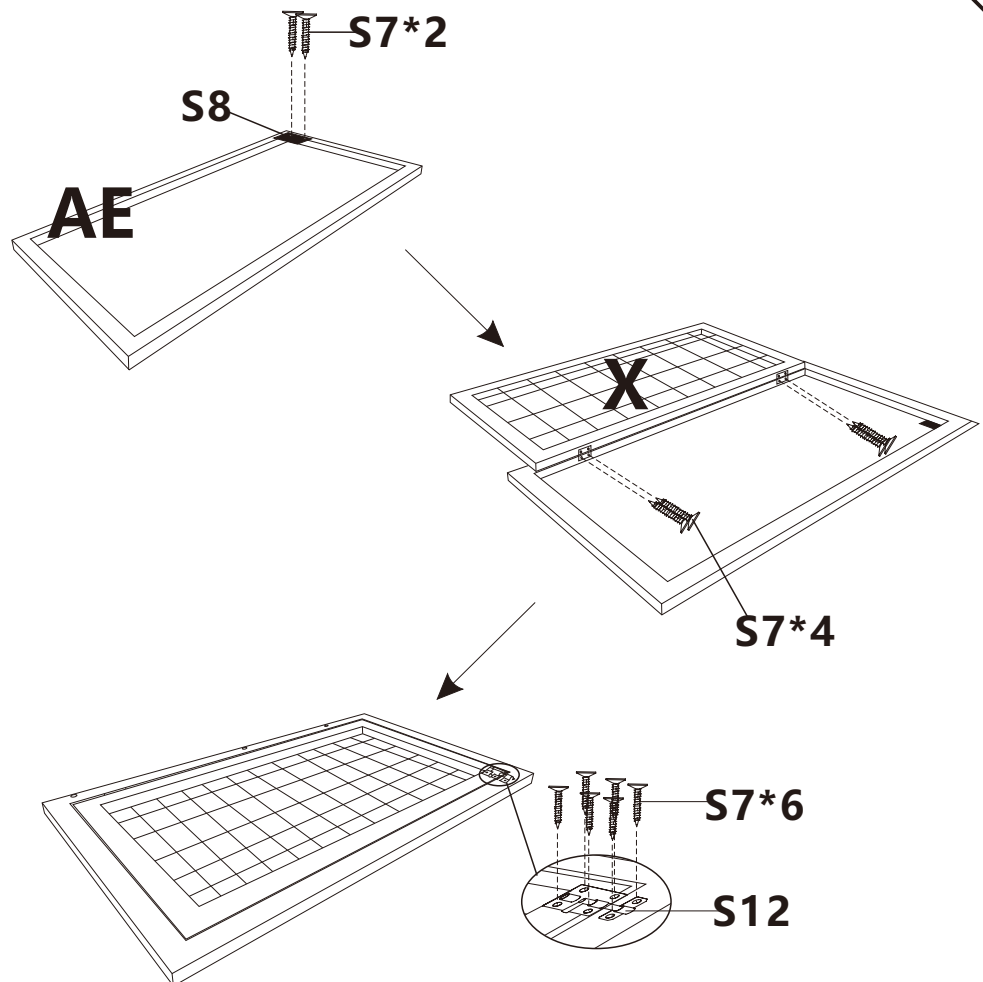

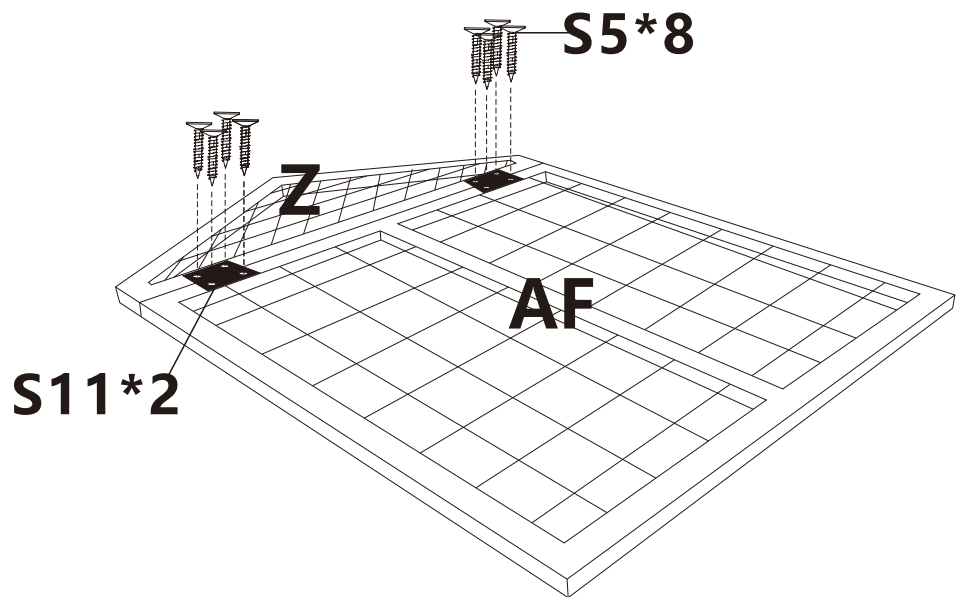
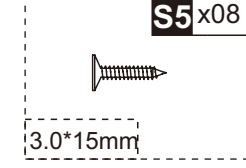
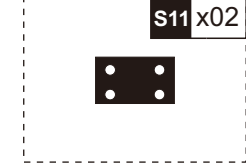
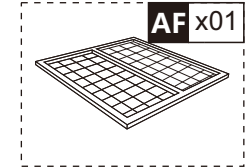
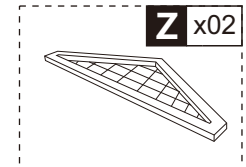
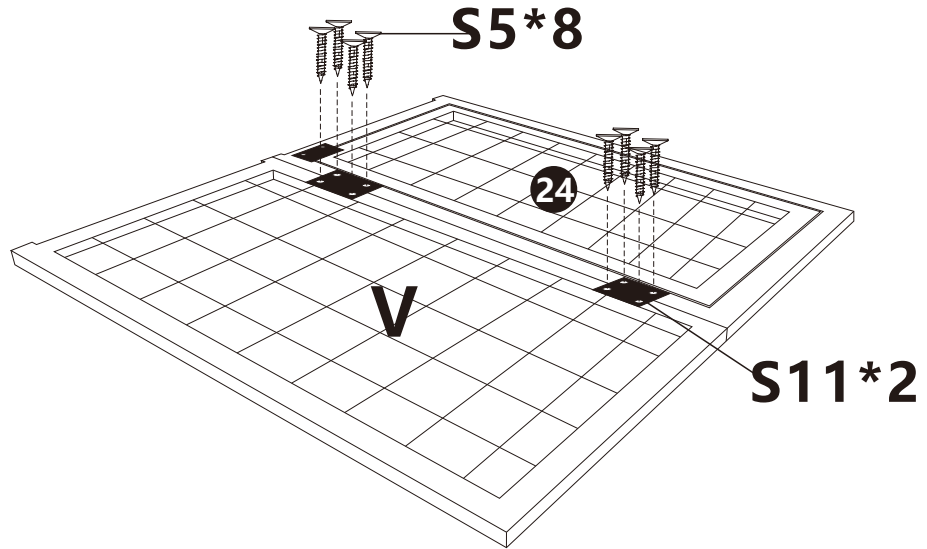
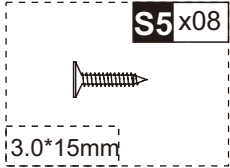
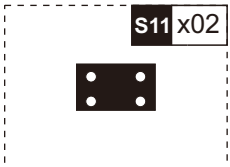
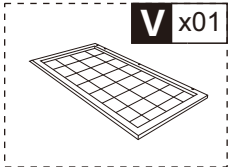
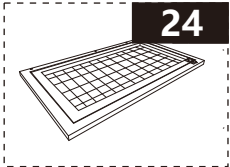

23

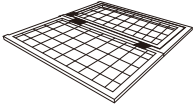

25

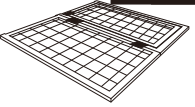

26

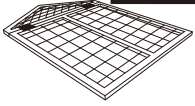

S1x08



3.5*30mm

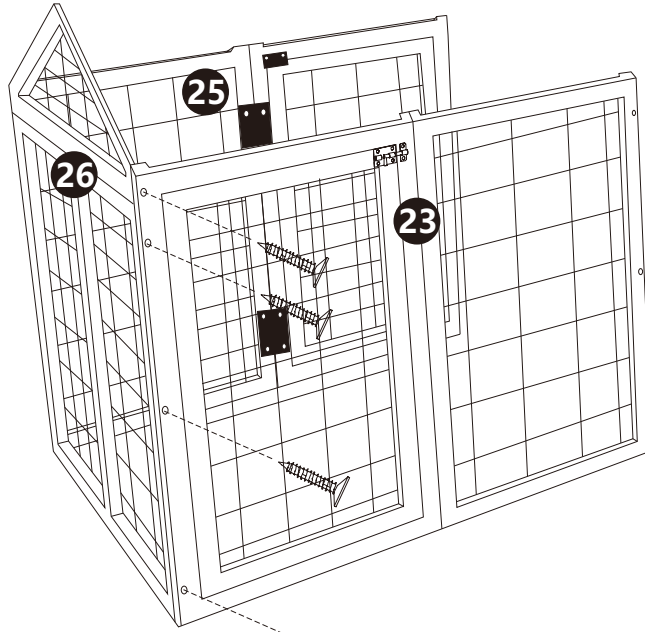

S1*8

21



T x02

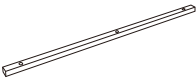

S1x06



3.5*30mm

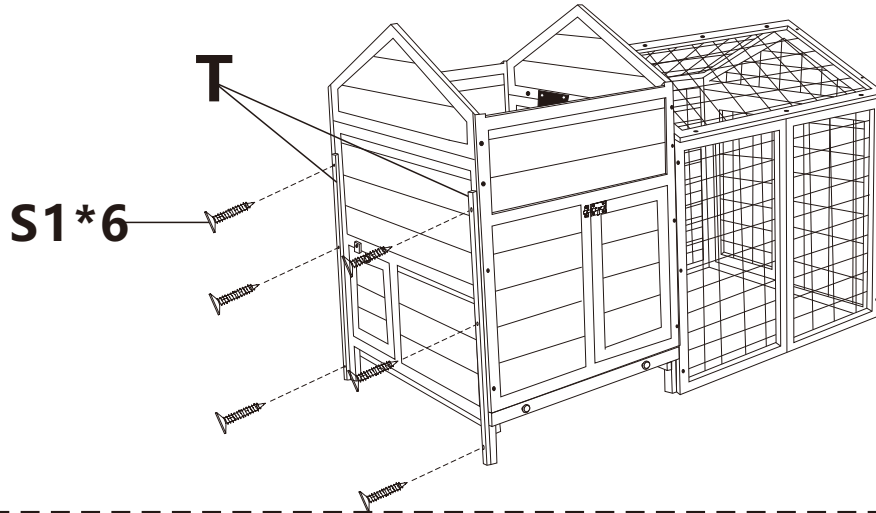

S1*6

T

21



T x02

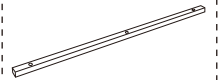

S1x06



3.5*30mm

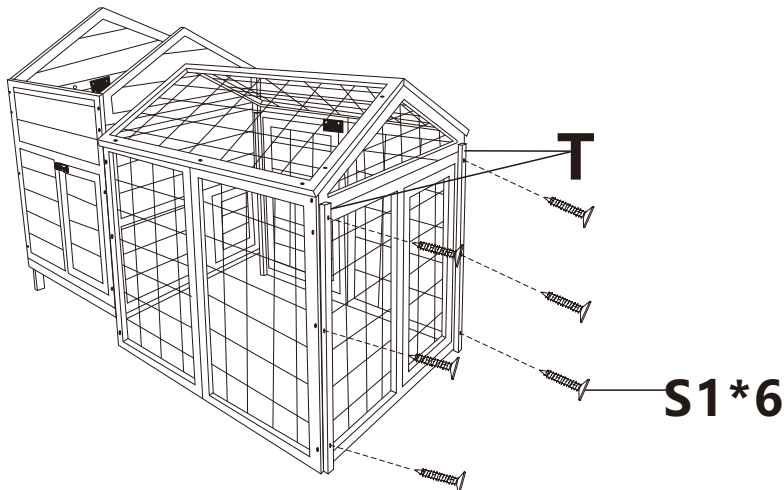

S1*6

T

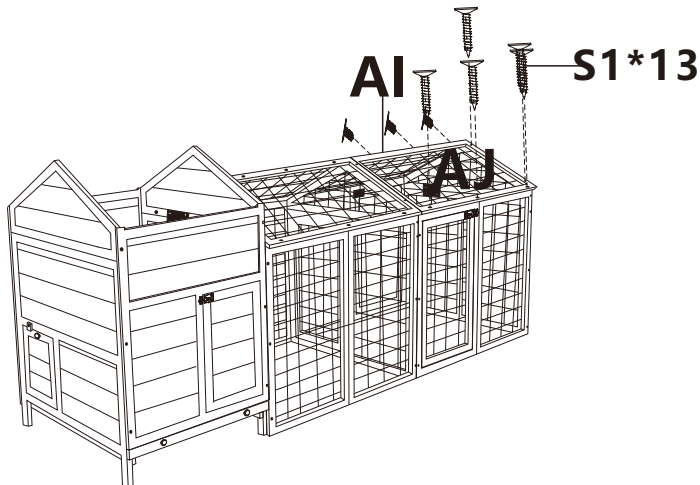
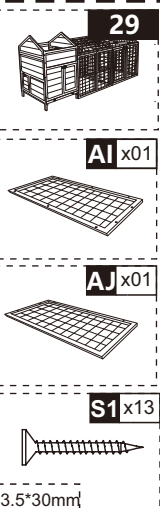
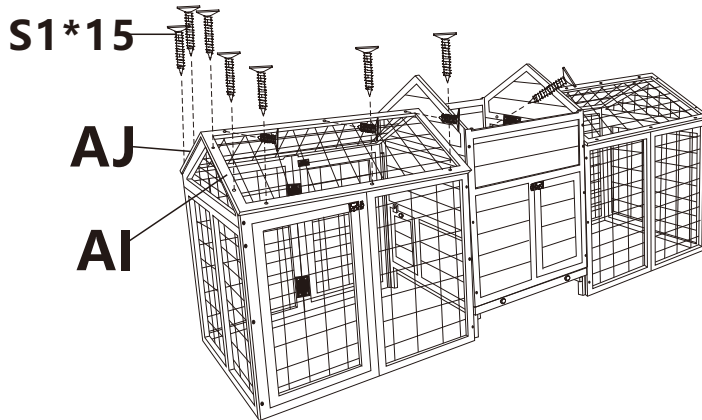
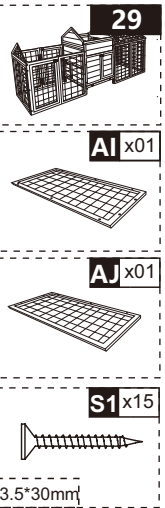
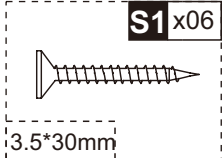
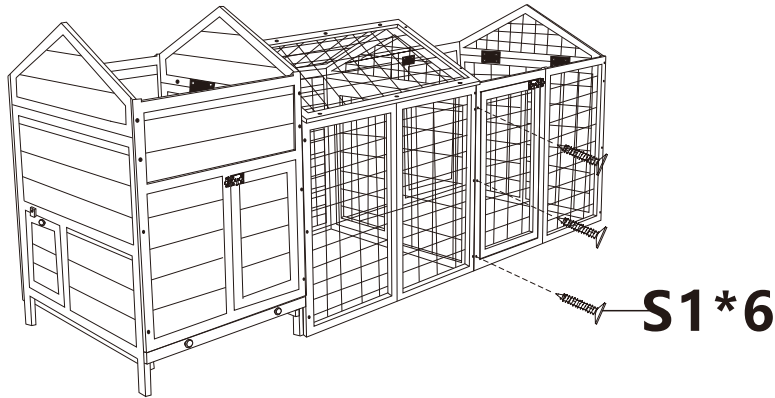
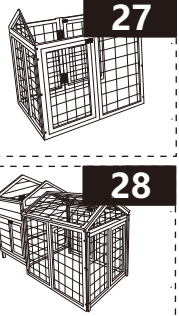
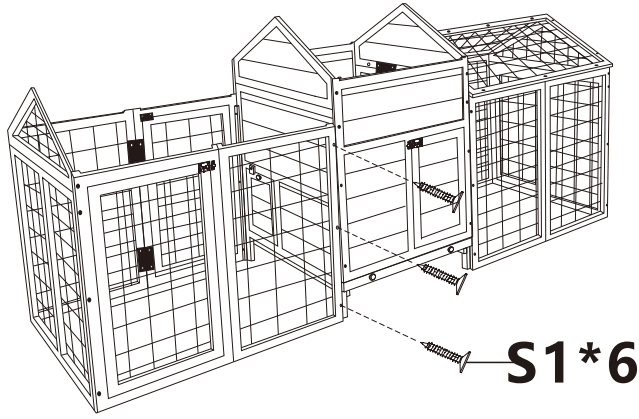
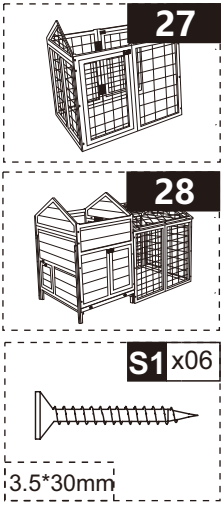

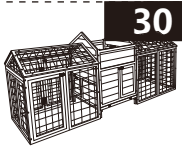

30

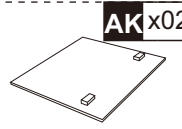

AKx02



S2x04

3.5*25mm

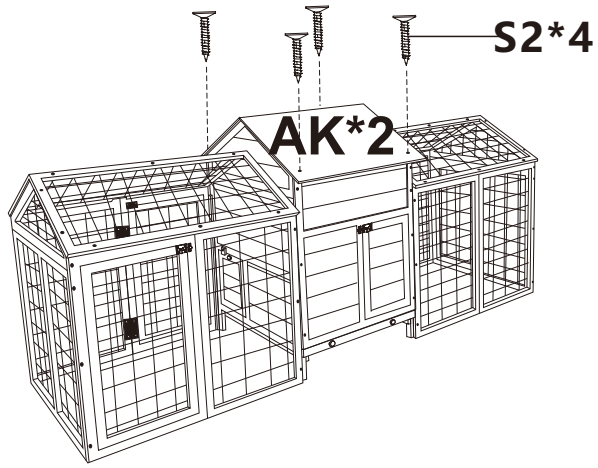

AK*2

S2*4



30

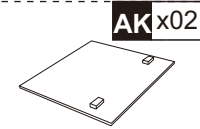

AKx02

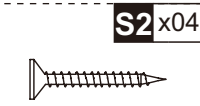

S2x04

3.5*25mm

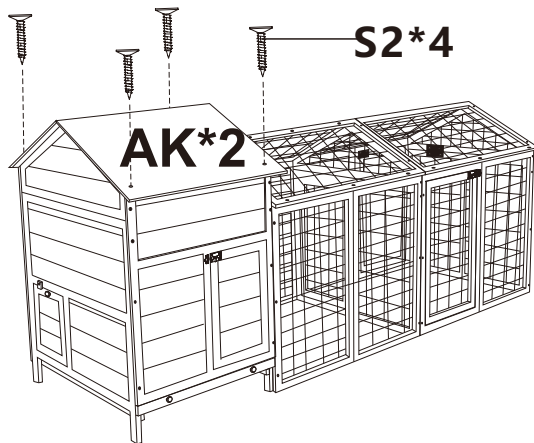

S2*4

AK*2

AL x01



AM x01



AN x02



S4 x07



3.0*18mm

S4*3

AL AM

S4*4

AN*2

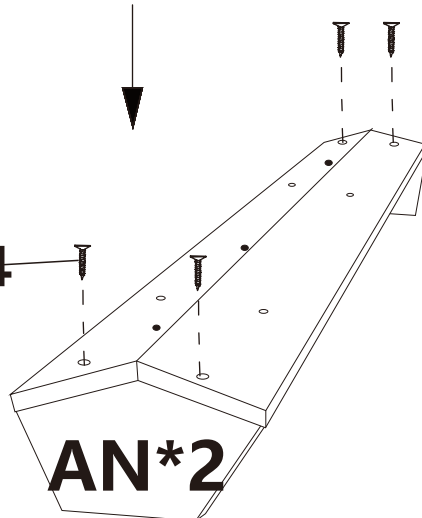
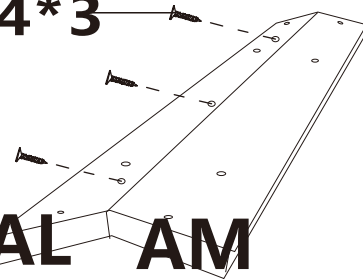

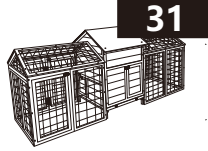

31

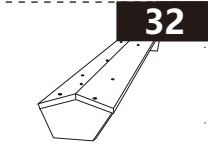

32

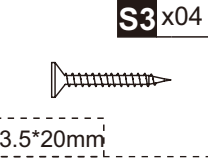

S3x04

3.5*20mm

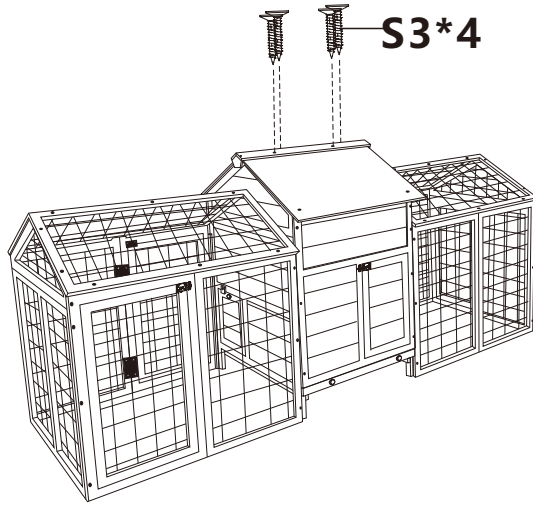

S3*4

31

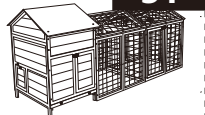

32

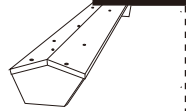

S3x04



3.5*20mm

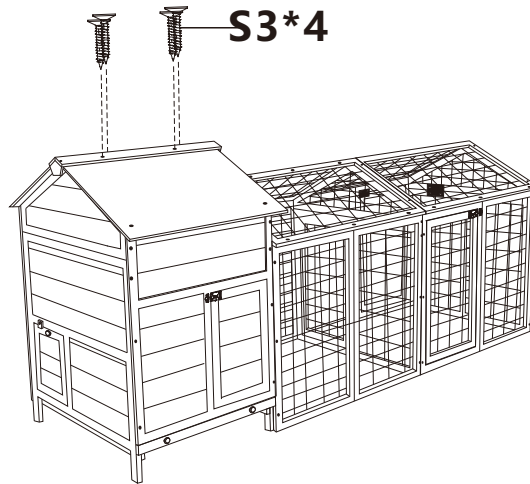

S3*4

33



AO x04



S4x12



3.0*18mm

AO*4

S4*12

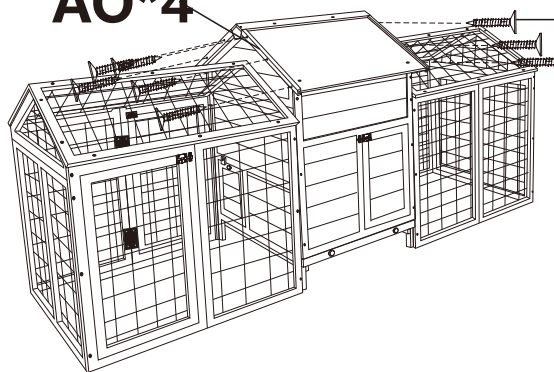

Done

33



AO x04



S4x12



3.0*18mm

AO*4

S4*12

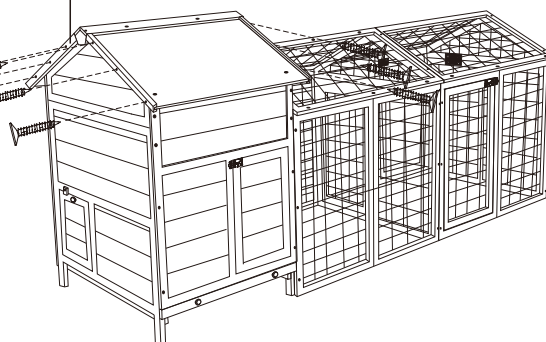

If you have any questions, please contact our customer care center, Our contact details are below:

US

 001-877-644-9366

 customerservice@aosom.com

Imported by Aosom LLC
27150 SW Kinsman Rd Wilsonville, OR 97070 USA
MADE IN CHINA

If you have any questions, please contact our customer care center, Our contact details are below:

CA

 416-792-6088

 customerservice@aosom.ca

Imported by Aosom Canada Inc.
7270 Woodbine Avenue, Unit 307, Markham,
Ontario Canada L3R 4B9
MADE IN CHINA

Si vous avez la moindre question, veuillez contacter notre centre d'assistance à la clientèle, Nos coordonnées sont les suivantes:

 416-792-6088

 customerservice@aosom.ca

Importé par Aosom Canada Inc.
7270 Woodbine Avenue, unité 307,
Markham, Ontario Canada L3R 4B9
FABRIQUÉ EN CHINE

If you have any questions, please contact our customer care center, Our contact details are below:

UK

 0044-800-240-4004

 enquiries@mhstar.co.uk

IMPORTER ADDRESS:
MH STAR UK LTD
Unit 27, Perivale Park,
Horsenden lane South
Perivale, UB6 7RH
MADE IN CHINA

Si vous avez la moindre question, veuillez contacter notre centre d'assistance à la clientèle, Nos coordonnées sont les suivantes:

FR

 0033-1-84166106

 aosom@mhfrance.fr

Importé par/Fabricant/REP:
MH FRANCE
2 Rue Maurice Hartmann
92130 Issy Les Moulineaux
France
FABRIQUÉ EN CHINE

Wenn Sie Fragen haben, wenden Sie sich bitte an unser Kundendienstzentrum, Unsere Kontaktdaten stehen unten:

DE

 0049-0(40)-88307530

 service@aosom.de

ADRESSE DES IMPORTEURE/Hersteller/REP:
MH Handel GmbH
Wendenstraße 309
D-20537 Hamburg
Germany
IN CHINA HERGESTELLT

In caso di dubbio, si prega di contattare il nostro centro assistenza clienti, I nostri dettagli di contatto sono di seguito:

IT

 0039-0249471447

 clienti@aosom.it

IMPORTATO DA/Produttore/REP:
AOSOM Italy srl
Centro Direzionale Milanofiori
Strada 1 Palazzo F1
20057 Assago (MI)
P.I.: 08567220960
FATTO IN CINA

Si tiene alguna pregunta, comuníquese con nuestro Centro de Atención al Cliente, Nuestros datos de contacto son los siguientes:

ES

 0034-931294512

 atencioncliente@aosom.es

IMPORTADOR/Fabricante/REP:
SPANISH AOSOM, S.L.
C/ROC GROS, N°15.08550, ELS HOSTALETS DE
BALENYÀ, SPAIN.
B66295775
HECHO EN CHINA

Se tiver alguma dúvida, por favor contacte o nosso Centro de Atendimento ao Cliente, Os nossos dados de contacto são os seguintes:

PT

 0034-931294512

 info@aosom.pt.

IMPORTADOR/Fabricante/REP:
SPANISH AOSOM, S.L.
C.ROC GROS N.15, 08550. ELS HOSTALETS DE
BALENYÀ
FEITO NA CHINA



FR

**DONNEZ
OU
RECYCLEZ**



ASSOCIATION

OU



LIVRAISON

OU



DÉCHÈTERIE

Adresses sur quefairedemesdechets.fr