

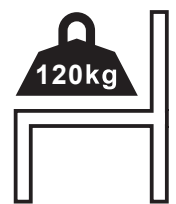

IN231200119V01_UK

860-335V70

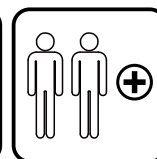
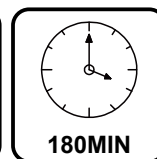
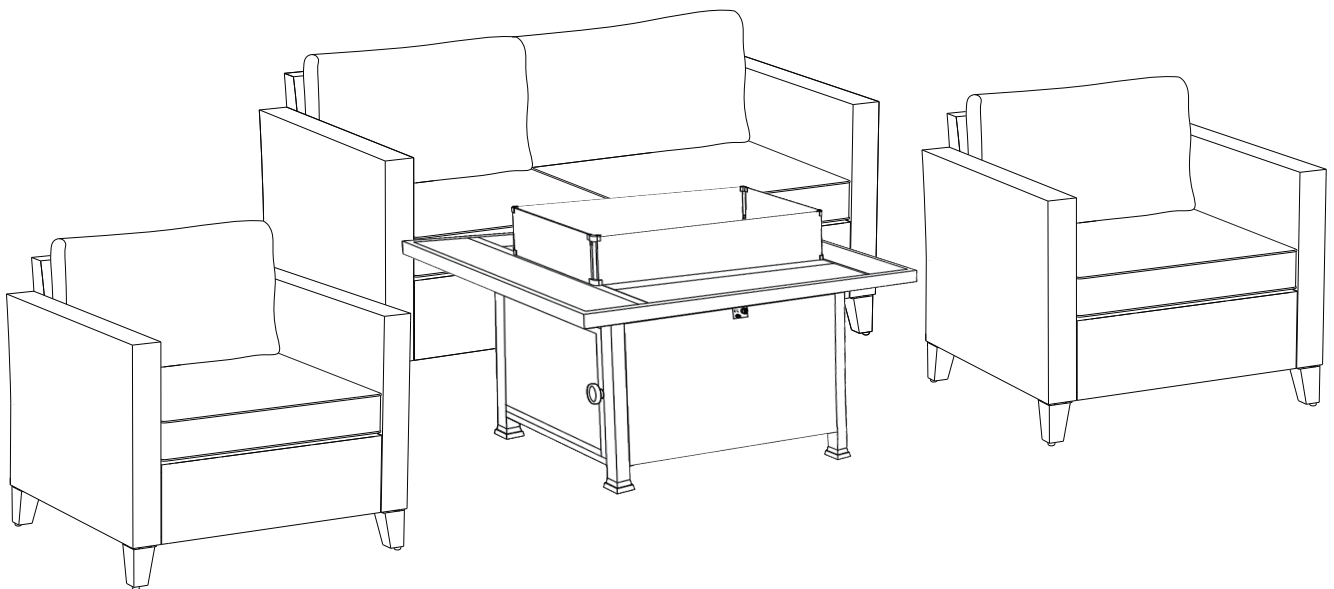

IMPORTANT, RETAIN FOR FUTURE REFERENCE: READ CAREFULLY

ASSEMBLY INSTRUCTIONS

IMPORTANT, RETAIN FOR FUTURE REFERENCE: READ CAREFULLY.

Only for domestic use

Use tips:

- *Put the chair stably on a flat floor.
- *Mount the garden chairs in the shelter of the weather.
- *Stay away from open flames.
- *Don't hang anything in the structure.
- *Avoid the overload at the anchors/structure.
- *It is advised that don't stay on the chairs when there is a storm.
- *Do not use in adverse weather condition and cover furniture when not in use.

Precautions before assembly:

- *Prepare a clean and dry mounting area.
- *Verify that the product is not damaged.
- *Check that none of the pieces are missing.

Maintenance:

- *Clean with a soft fabric.
- *Regularly remove leaves and / or water collected on the canvas.
- *Check the chair regularly.

Storage conditions:

- *The fabric should be stored completely dry, in a clean and dry place to avoid the risks of mold.











Maintenance:

- *Don't use this product if the seat cloths, cloth cushion or tarpaulins are ageing, and contact our customer service.

Caution with the risks of pinching or cuts during assembly.

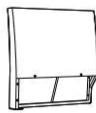





The manufacturer declines all responsibility in case of damages due to a bad installation or due to weather.















PACKING DETAILS: TOTAL 5 BOXES

BOX-1/5			BOX-2/5		
NO.	PARTS	QTY	NO.	PARTS	QTY
3		1	3		1
4		1	4		1
5		1	7		1
6		1	8		1
10		2	10		2

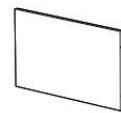

Hardware Kit

BOX-3/5			BOX-4/5		
NO.	PARTS	QTY	NO.	PARTS	QTY
1		3	29		1
2		3	22		2
9		16	23		2
			11		4

BOX-5/5			BOX-5/5		
NO.	PARTS	QTY	NO.	PARTS	QTY
12		1	20		4
13		1	21		1
14		1	24		2
15		1	25		2
16		1	26		4
17		1	27		4
18		1	28		1
19		1			

22005 Patio Wicker Single Sofa

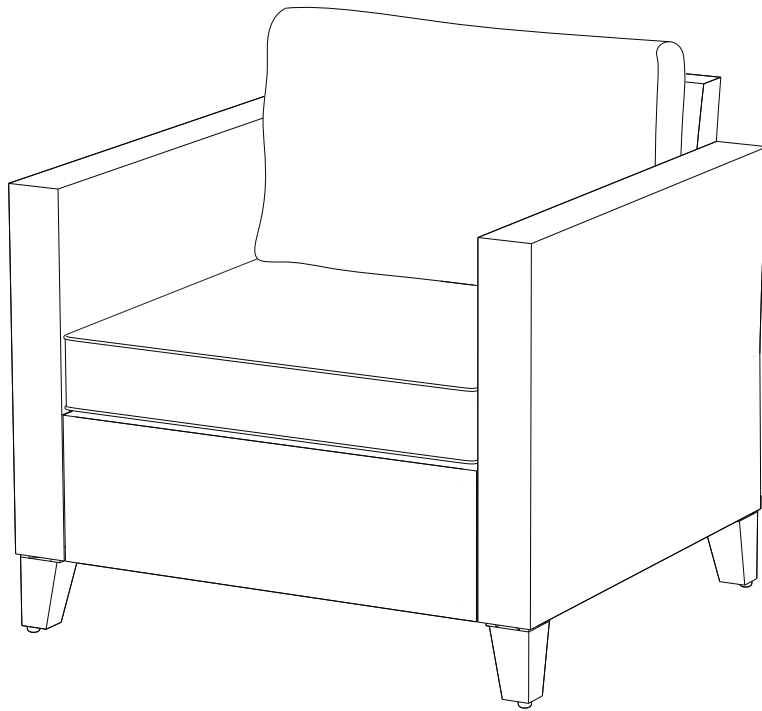

Attention



Thanks for choosing our product.





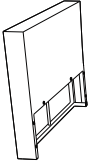
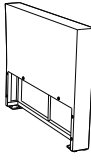
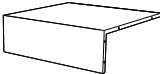
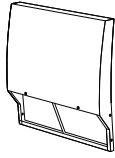

1. We care about each customer's user experience. Please feel free to contact us if you have any questions, such as missing parts, or defective parts in transit. We will offer good solutions to you ASAP.

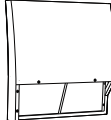
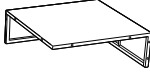

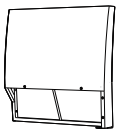
2. Use the correct bolts as indicated. Do not tighten any of the bolts until the unit is completely assembled, then finish tightening all bolts. Must tighten all of bolts before using this item.



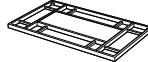

3. Do not discard any of the packaging until you have checked that you have all of the parts and fittings required.

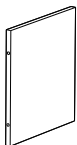
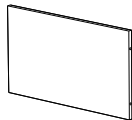
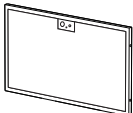
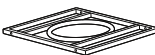
4. We recommend to use a waterproof cover for this patio sofa set when not in use, especially in rainy days, in order to prolong item life.



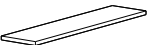
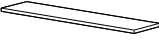
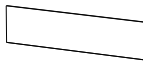



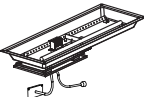

①	②	③	④	⑤	⑥	⑦
						
3 PCS	3 PCS	2 PCS	2 PCS	1 PCS	1 PCS	1 PCS







⑧	⑨	⑩	⑪	⑫	⑬	⑭
						
1 PCS	16 PCS	4 PCS	4 PCS	1 PCS	1 PCS	1 PCS

⑮	⑯	⑰	⑱	⑲	⑳	㉑
						
1 PCS	1 PCS	1 PCS	1 PCS	1 PCS	4 PCS	1 PCS

㉒	㉓	㉔	㉕	㉖	㉗	㉘
						
2 PCS	2 PCS	2 PCS	2 PCS	4 PCS	4 PCS	1 PCS

㉙	
	
1 PCS	

A	B	C	D	E	F	G	H
 M6x35 mm	 M6x40 mm	 M8x60 mm	 ø6 mm	 ø8 mm	 M8		
44 PCS	20 PCS	16 PCS	72 PCS	16 PCS	16 PCS	1 PCS	1 PCS

I	J	K	L	M	N	
 M6x15 mm	 M6x15 mm					
8 PCS	4 PCS	16 PCS	4 PCS	1 PCS	1 PCS	

Assembly Instructions

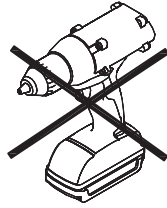

Do not tighten any of the bolts until the unit is completely assembled, then finish tightening all bolts. Must tighten all of bolts before using this item.

①	1
③	1
A	2
B	2
D	4
H	1

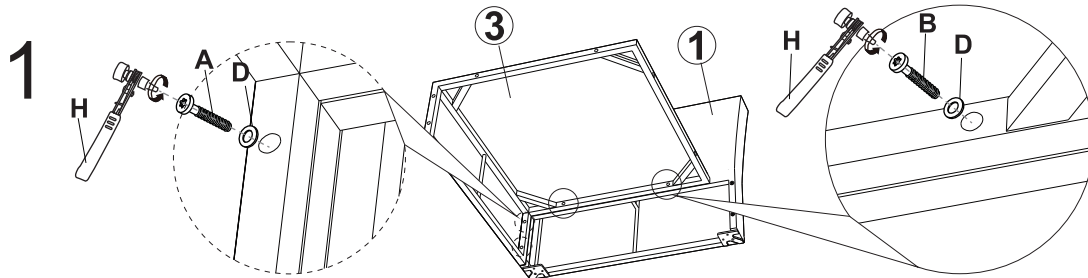

②	1
A	2
B	2
D	4
H	1

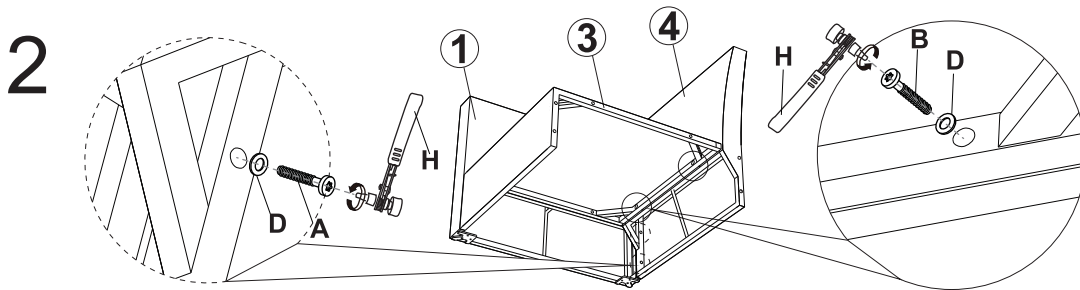

②	1
A	4
B	2
D	6
H	1

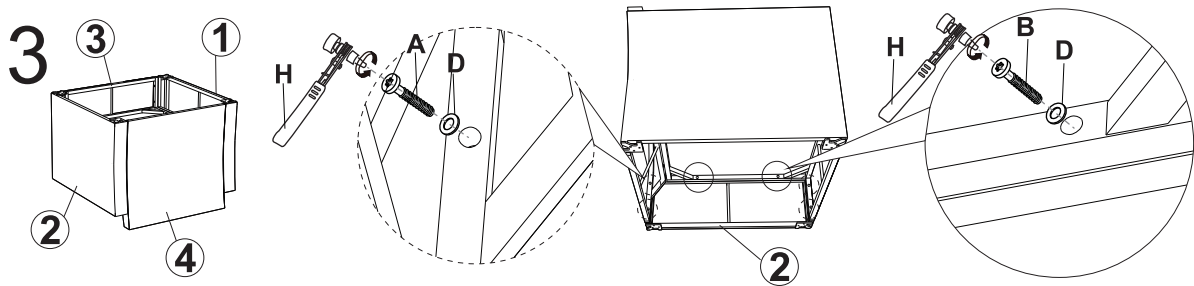

⑨	4
C	4
E	4
F	4
G	1

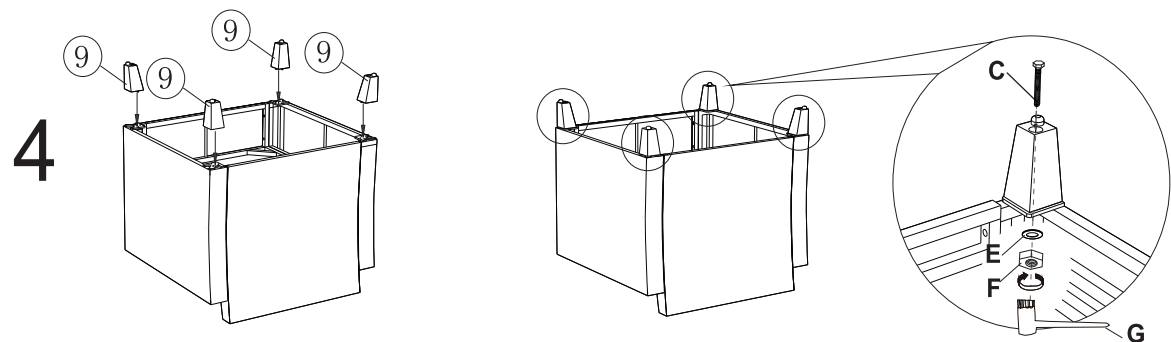

⑩	1
⑪	1

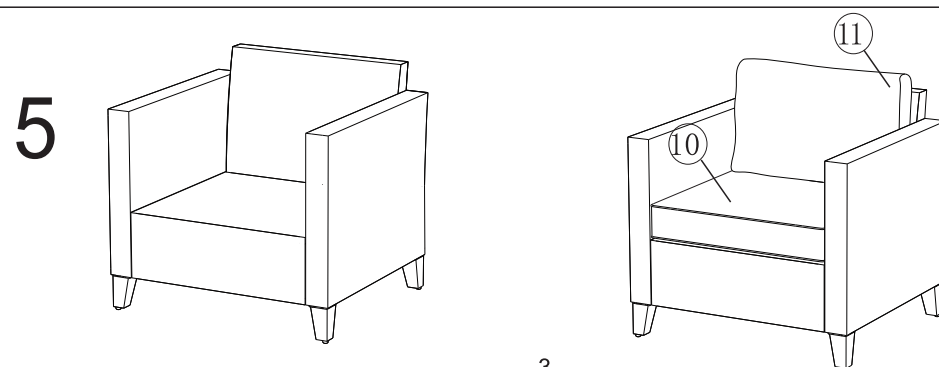

22007 Patio Wicker Right Arm Sofa

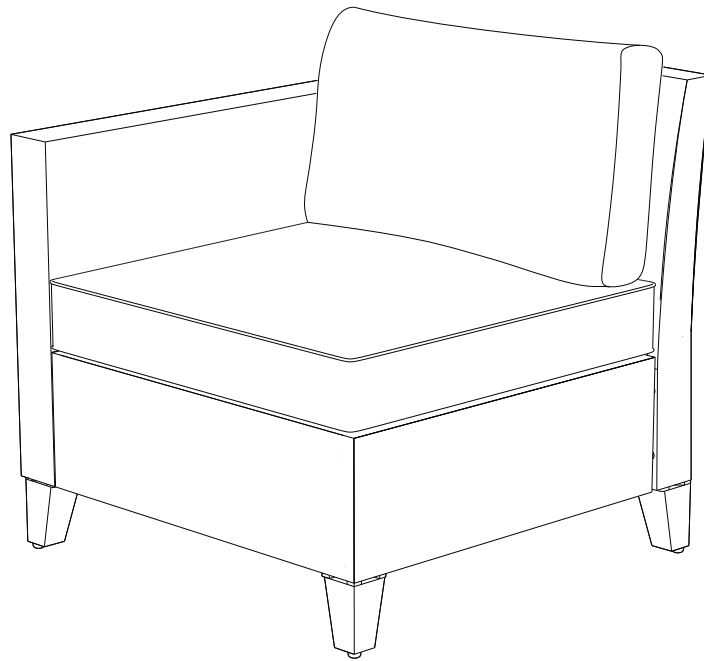

Attention

Thanks for choosing our product.

1. We care about each customer's user experience. Please feel free to contact us if you have any questions, such as missing parts, or defective parts in transit. We will offer good solutions to you ASAP.

2. Use the correct bolts as indicated. Do not tighten any of the bolts until the unit is completely assembled, then finish tightening all bolts. Must tighten all of bolts before using this item.

3. Do not discard any of the packaging until you have checked that you have all of the parts and fittings required.

4. We recommend to use a waterproof cover for this patio sofa set when not in use, especially in rainy days, in order to prolong item life.

Assembly Instructions

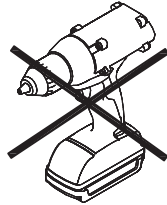

Do not tighten any of the bolts until the unit is completely assembled, then finish tightening all bolts. Must tighten all of bolts before using this item.

①	1
⑦	1
A	2
B	2
D	4
H	1

6

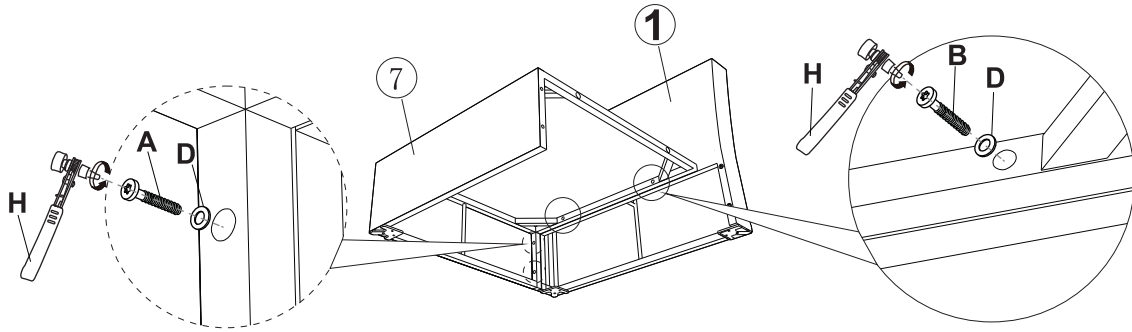

⑧	1
A	2
D	2
H	1

7

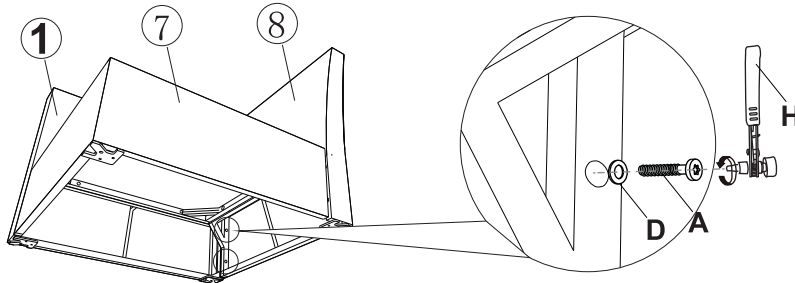

A	2
B	2
D	4
H	1

8

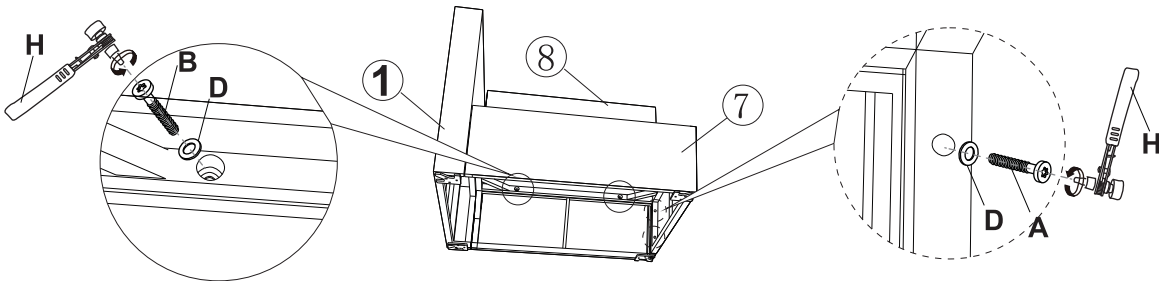

⑨	4
C	4
F	4
E	4
G	1

9

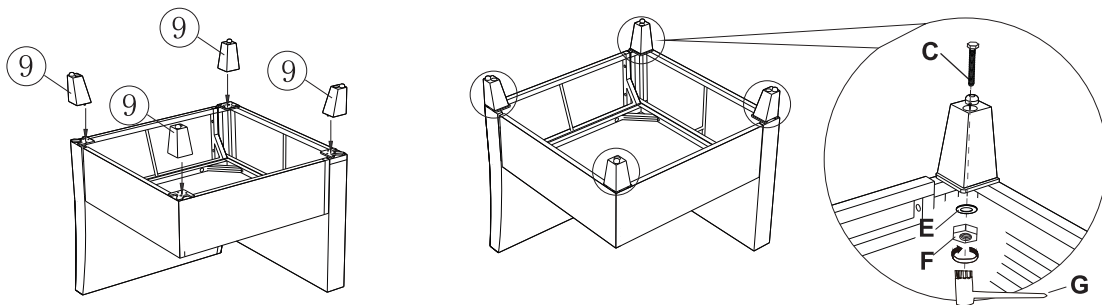

⑩	1
⑪	1

10

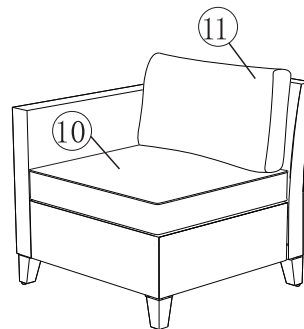
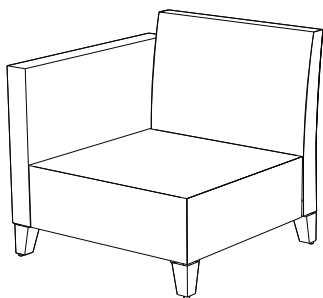

22008 Patio Wicker Left Arm Sofa

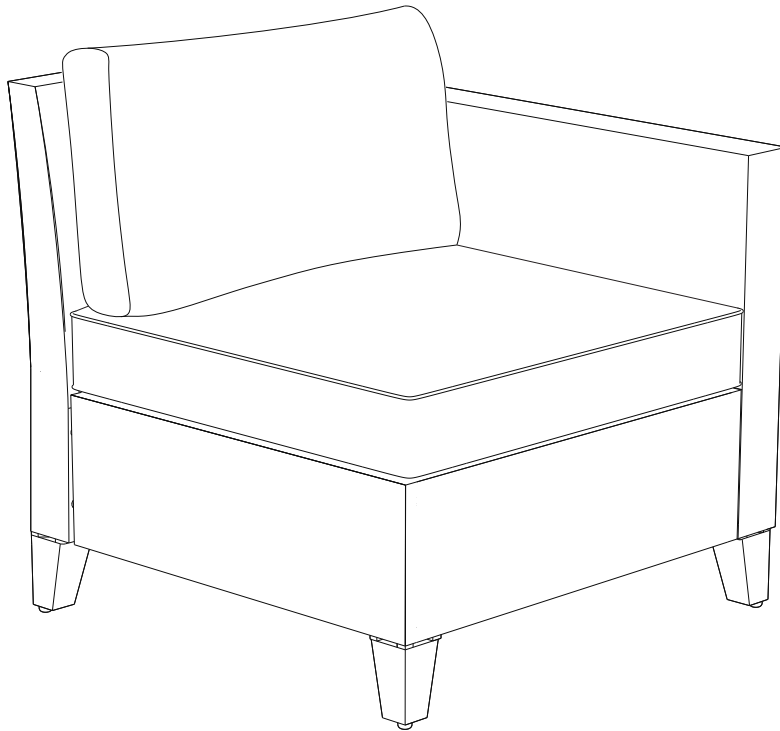

Attention

Thanks for choosing our product.

1. We care about each customer's user experience. Please feel free to contact us if you have any questions, such as missing parts, or defective parts in transit. We will offer good solutions to you ASAP.

2. Use the correct bolts as indicated. Do not tighten any of the bolts until the unit is completely assembled, then finish tightening all bolts. Must tighten all of bolts before using this item.

3. Do not discard any of the packaging until you have checked that you have all of the parts and fittings required.

4. We recommend to use a waterproof cover for this patio sofa set when not in use, especially in rainy days, in order to prolong item life.

Assembly Instructions

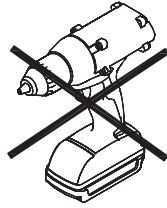

Do not tighten any of the bolts until the unit is completely assembled, then finish tightening all bolts. Must tighten all of bolts before using this item.

②	1
⑤	1
A	2
B	2
D	4
H	1

11

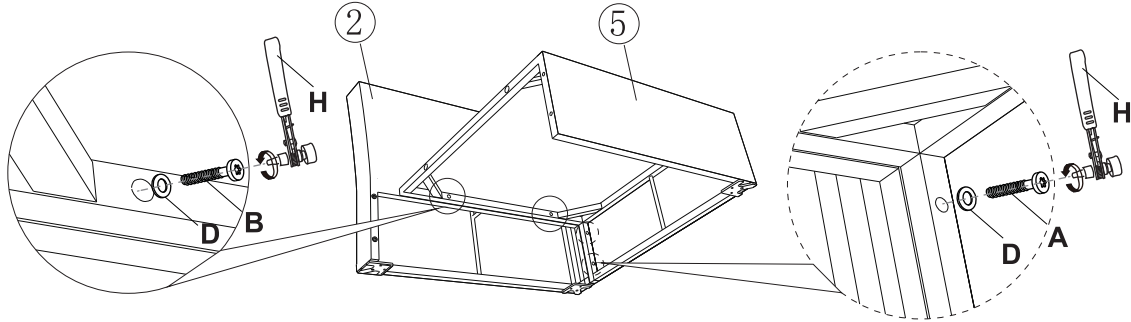

⑥	1
A	2
D	2
H	1

12

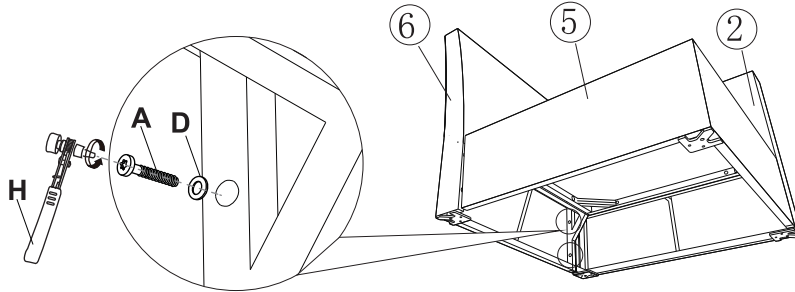

A	2
B	2
D	4
H	1

13

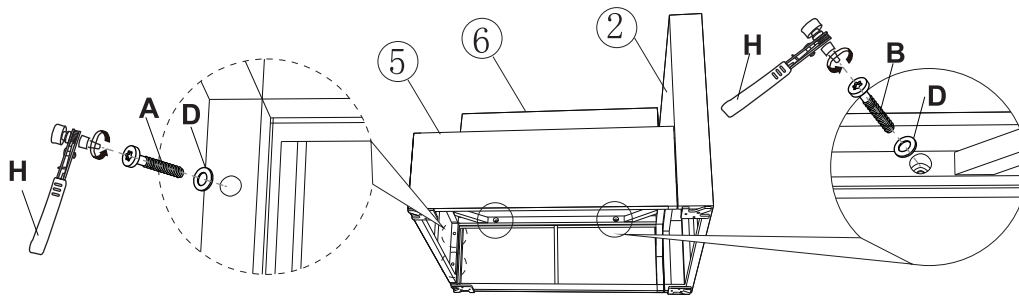

⑨	4
C	4
F	4
E	4
G	1

14

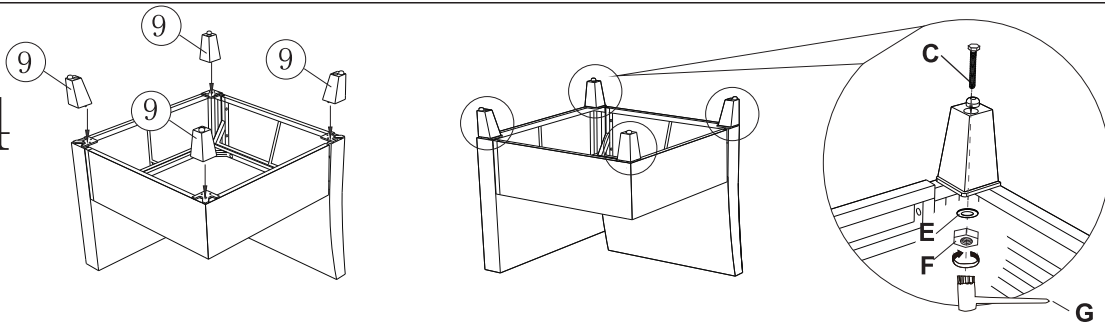

⑩	1
⑪	1

15

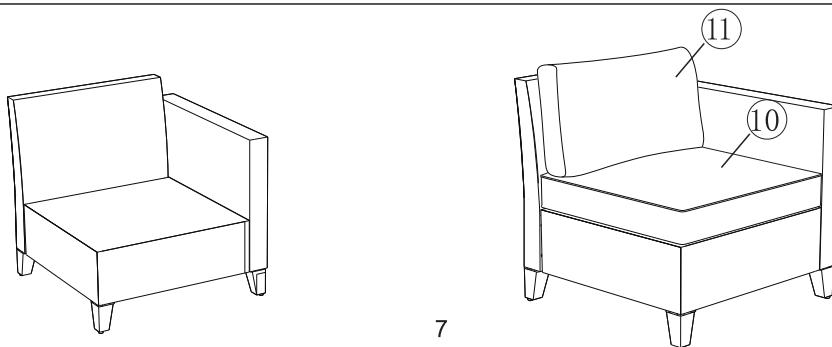

Outdoor use gas firepit.

Model: XYT-015

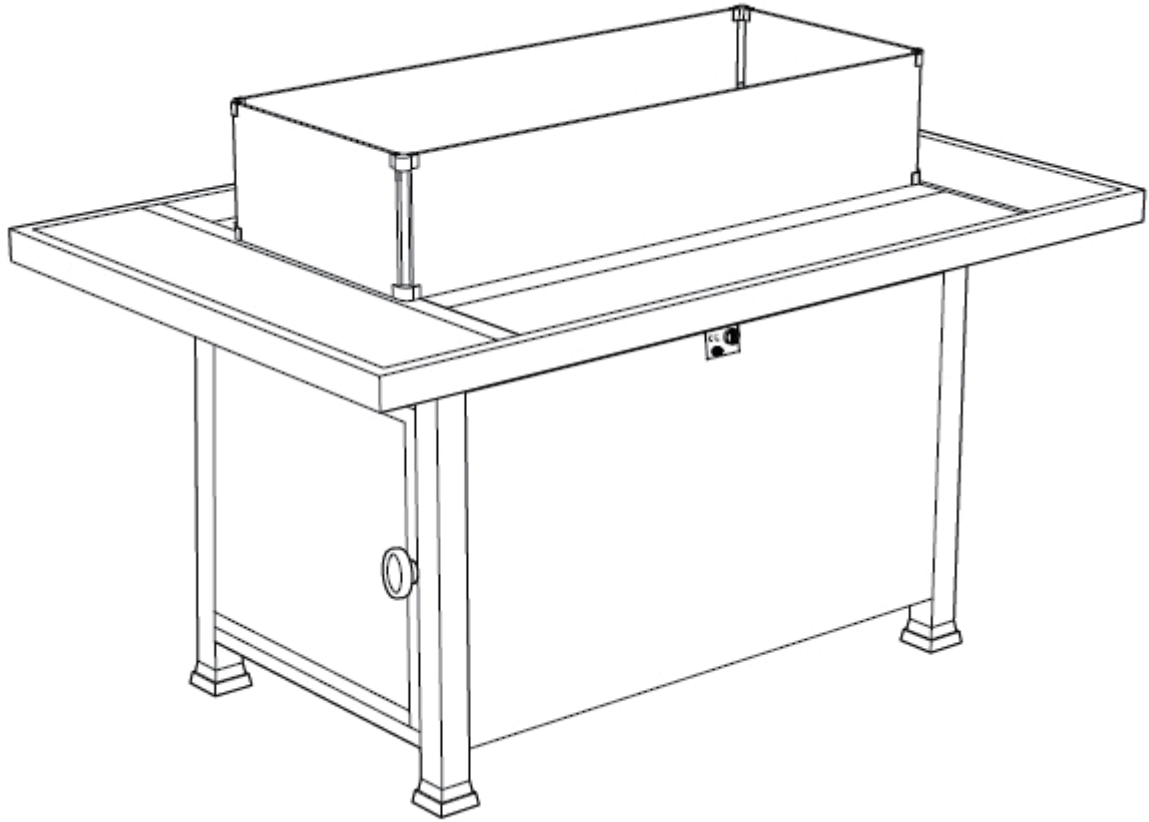

Instruction Manual

Please read the manual BEFORE you unpack or install the fire

CE 1336-23

WARNING

**PLEASE READ CAREFULLY THE FOLLOWING SAFETY GUIDELINES BEFORE OPERATION AND INSTALLATION
REPAIRS SHOULD ONLY BE DONE BY A QUALIFIED TECHNICIAN**

Do not use this appliance for indoors, as it may cause personal injury or property damage. THIS APPLIANCE MUST ONLY BE USED OUTDOORS.

Do not connect the heater to any gas supply until it has been fully assembled.

This outdoor heater is not intended to be installed on recreational vehicles and/or boats.

Appliance should be located on a solid surface.

Maintenance and repair should be carried out by a qualified technician.

Improper installation, adjustment, alteration can cause personal injury or property damage.

Do not attempt to alter the unit in any manner. Any modifications may be dangerous and are not permitted.

Do not store or use petroleum or other flammable vapors or liquids in or near the heater unit.

The whole gas system, hose, regulator, pilot or burner should be inspected for leaks or damage before use, and at least annually by a qualified technician.

All leak tests should be done with a soap solution. Never use an open flame to check for leaks.

Do not use the heater until all connections have been leak tested.

Turn off the gas valve if smell of gas is detected and immediately shut off any gas supply.

Do not move heater while it is operation.

Do not move the heater until temperature has fully cooled after it has been turned off.

Control compartment, burner and circulation air passageways of the heater must be kept clean.

Frequent cleaning may be required as necessary.

All gas cylinders should be turned off when the heater is not in use.

Check the heater immediately if any of the following occurs:

- The heater does not reach temperature.

- The burner makes popping noises during use (a slight noise is normal when the burner is extinguished).

- Smell of gas in conjunction with extreme yellow tipping of the burner flames.

- The burner does not ignite or continues to go out

The gas regulator and hose assembly must be located in the cylinder cabinet where gas cylinder is installed.

Any guard or other protective device removed for servicing the heater must be replaced before further use.

Adults and children should stay away from high temperature surfaces to avoid personal injury or property damage. **WARNING:** Accessible parts may be very hot.

Children should be carefully supervised at all time when they are in the area of the heater.

Clothing or other flammable materials should not be hung on the heater or placed on or near the heater.

Do not use the heater for any form of cooking.

Do not throw anything into the heater.

Do not leave the heater unattended whilst in operation.

Do not use heater in excessively windy conditions.

Do not use heater in excessively rainy conditions, as this could lead to damage to components.

Ensure the gas supply is isolate and shut off when not in use and gas control valve is in the OFF position.

Follow all instructions regarding the use of LPG and Butane bottles. Please contact your local gas supplier for further advice if needed.

WARNING: Flames from the heater are almost invisible in direct sunlight.

Warning

- 1, The regulator shall comply with the standard EN16129;
For category I3+, the appliance shall use the butane 30mabar regulator (reduced pressure:28-30mbar) or the propane 37mbar regulator (reduced pressure: 37mbar).
For category I3B/P(30), the appliance shall use the LPG 30mabar regulator(reduced pressure:28-30mbar).
- 2, The hose shall comply with the standard EN 16436 and the length of the hose should not exceed 1.5m.
- 3, The minimum distance from non protected combustible materials shall be 1m.
- 4, To change the gas cylinder in a amply ventilated area, away from any ignition source (candle, cigarettes, other flame producing appliances, ...).
- 5, To check that the regulator seal is correctly fitted and able to fulfil its function.
- 6, Do not obstruct the ventilation holes of the cylinder housing.
- 7, Close the gas supply at the valve of the gas cylinder or the regulator after use.
- 8, In the event of gas leakage, the appliance shall not be used or if alight, the gas supply shall be shut off and the appliance shall be investigated and rectified before it is used again.
- 9, Check the tubing or the flexible hose (at least once per month and each time the cylinder is changed).
If it shows signs of cracking, splitting or other deterioration it shall be exchanged for new hose of the same length and of the equivalent quality;
- 10, Read the instructions before installation and use.
- 11, This appliance must be installed and the gas cylinder stored in accordance with the regulations in force.
- 12, Do not obstruct the ventilation holes of the cylinder housing.
- 13, Do not move the appliance when in operation.
- 14, Shut off the valve at the gas cylinder or the regulator before moving the appliance.
- 15, The tubing or the flexible hose must be changed within the prescribed intervals.
- 16, Use only the type of gas and the type of cylinder specified by the manufacturer.
- 17, In case of violent wind particular attention must be taken against tilting of the appliance,
- 18, Keep the instructions for future reference.
- 19, Do not connect the gas cylinder directly to the appliance without regulator.
- 20, The tubing or the flexible hose must be changed within the prescribed intervals.
- 21, Use only the type of gas and the type of cylinder specified in these instructions.
- 22, The injector is assembled by manufacturer only.

Specification

The product is designed to work with the following gas types.

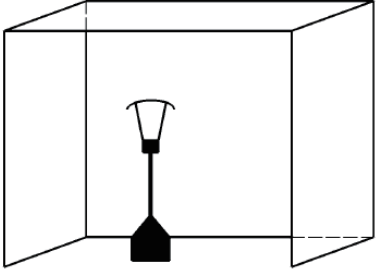
Item	JIANGSU XINYI OUTDOOR FURNITURE CO., LTD.		
Model	XYT-015	Serial number	
Appliance Category	I _{3+(28-30/37)} <input checked="" type="checkbox"/>		I _{3B/P(30)} <input type="checkbox"/>
Country code	BE, CH, CY, CZ, ES, FR, GB, GR, IE, IT, LT, LU, LV, PT, SK, SI	BE, CY, CZ, DK, EE, FI, FR, HU, IT, LT, NL, NO, SE, SI, SK, RO, HR, TR, BG, IS, LU, MT	
Country Destination	IE		
One AAA battery (1.5Vdc)			
Reference gas	Butane	Propane	Butane or propane
Supply pressure(mbar)	28-30	37	30
Injector size (mm)	2.05mm		2.05mm
Nominal heat input(Hs) (kW)	16.80 kW (G30:1222 g/h; G31: 1200 g/h)		16.80 kW (1222 g/h)
 CE 1336-23 PIN : 1336D0060			
<ul style="list-style-type: none"> • Close the valve of the gas cylinder or the regulator after use. • The use of this appliance in enclosed areas can be dangerous and is PROHIBITED. • Read the instructions before using this appliance. • The appliance must be installed in accordance with the instructions and local regulations. • For use outdoors or in amply ventilated areas. • An amply ventilated area must have a minimum of 25 % of the surface area open. • The surface area is the sum of the walls surface. • Be careful, accessible parts may be very hot. Keep away from young children. 			
			
Manufacture: JIANGSU XINYI OUTDOOR FURNITURE CO., LTD Address: Shaodian Industrial Park, XinYi ,Xuzhou City, JiangSu Province, China.			

For use outdoors or in amply ventilated areas.

An amply ventilated area must have a minimum of 25 % of the surface area open.

The surface area is the sum of the walls surface.

GETTING STARTED

Please read instruction thoroughly before using the appliance.



























The gas heater will arrive in one box containing the appliance with burner already installed, castor wheels, glass or lava rock fuel beds . And rain cover(optional) if were ordered.

Remove the appliance from packaging. Carefully place it down on the floor, keeping it upright for ease of assembly.

Extreme care should be taken when handling the heater, to ensure the gas pipes, thermocouple lead, gas valve or burner are not damaged or loosened in anyway.

Please note: ALL heaters have been burn tested and leak tested prior to leaving the factory. Although each unit is cleaned, there may be the odd scorch mark around the pilot and main burner gas jets.

WHAT'S INCLUDED

⑫	⑬	⑭	⑮	⑯	⑰	⑱	
							
1 PCS	1 PCS	1 PCS	1 PCS	1 PCS	1 PCS	1 PCS	
⑲	⑳	㉑	㉒	㉓	㉔	㉕	
							
1 PCS	4 PCS	1 PCS	2 PCS	2 PCS	2 PCS	2 PCS	
㉖	㉗	㉘	㉙				
							
4 PCS	4 PCS	1 PCS	1 PCS				
D	H	I	J	K	L	M	N
 ø6 mm		 M6x15 mm	 M6x15 mm				
24 PCS	1 PCS	8 PCS	4 PCS	16 PCS	4 PCS	1 PCS	1 PCS

Assembly Instructions

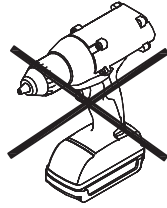

! Do not tighten any of the bolts until the unit is completely assembled, then finish tightening all bolts. Must tighten all of bolts before using this item.

12	1
13	1
14	1
15	1
D	4
H	1
I	4

16

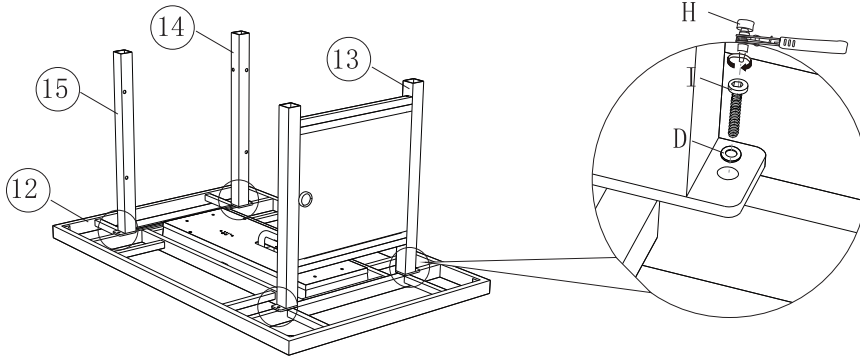

16	1
A	4
H	1
D	4

17

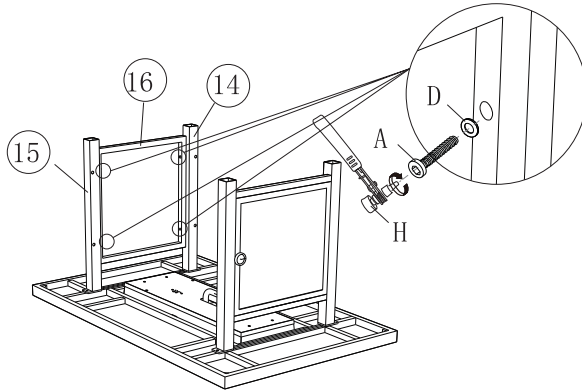

17	1
18	1
A	8
H	1
D	8

18

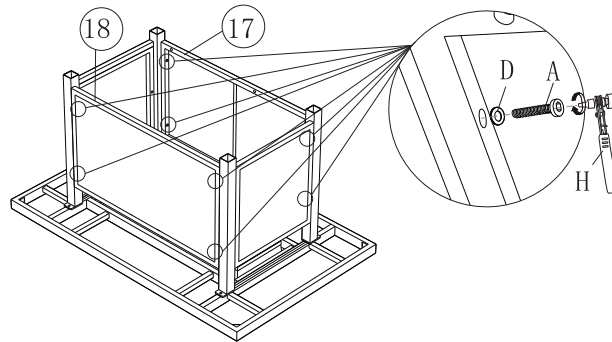

19	1
A	4
H	1
D	4

19

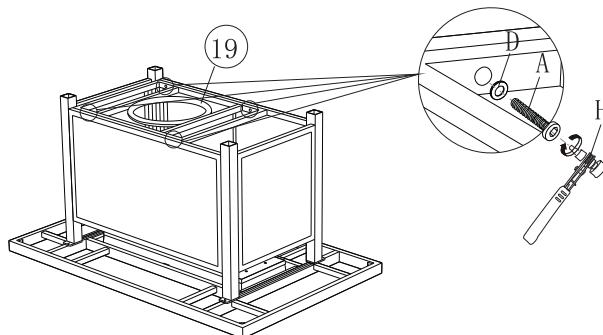

20	4
----	---

20

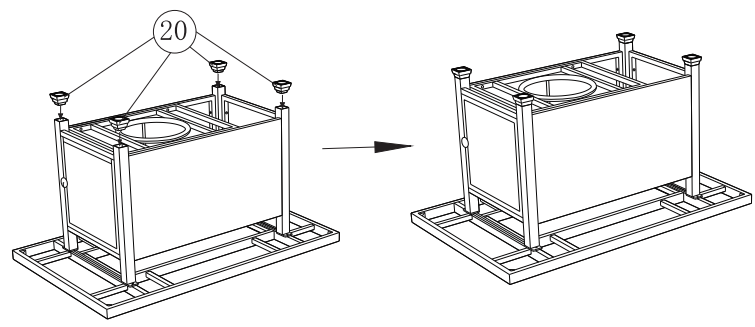

I	4
J	4
D	4
29	1

21

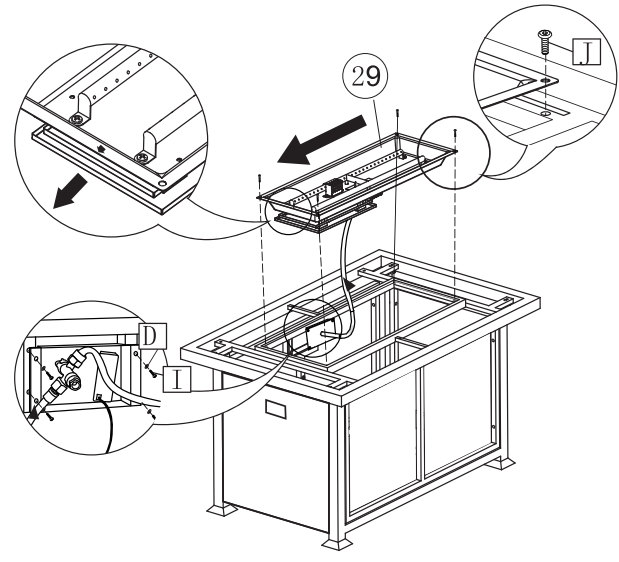

22	2
23	2

22

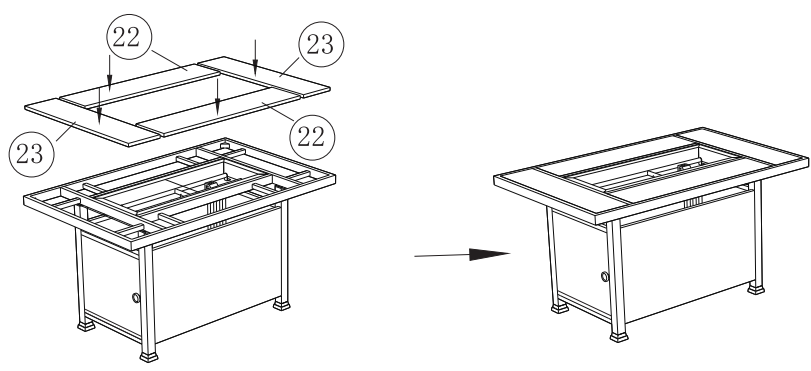

28	1
----	---

23

CAUTION: Do not hang clothing or any other flammable materials from the heater, or place on or near the heater. HOT! DO NOT TOUCH!

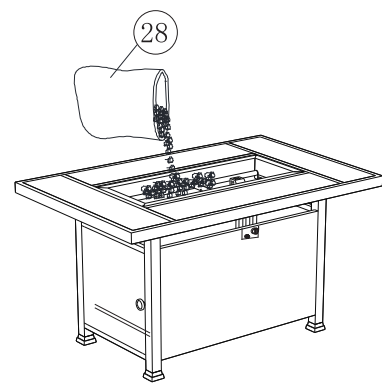

CAUTION-HOT SURFACE

HOT WHILE IN OPERATION
DO NOT TOUCH
KEEP CHILDREN, CLOTHING
FURNITURE AND FLAMMABLES AWAY



24

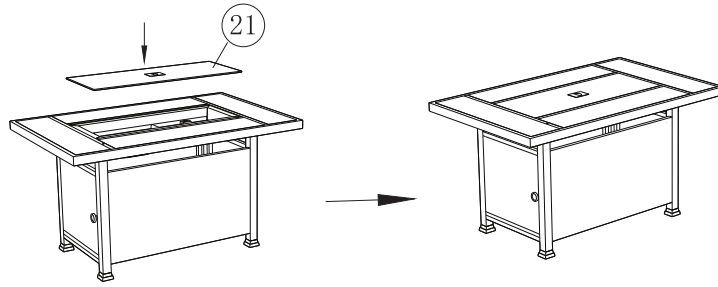

24	2
25	2
26	4
27	4
K	16
L	4
N	1

25

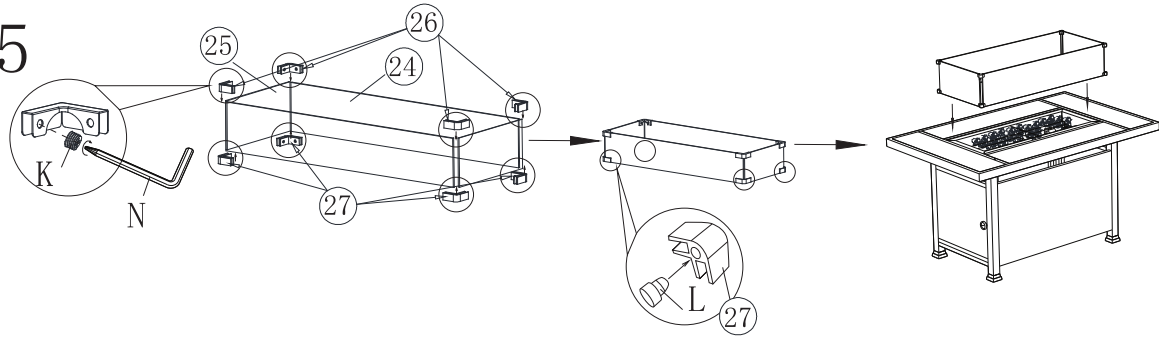

26

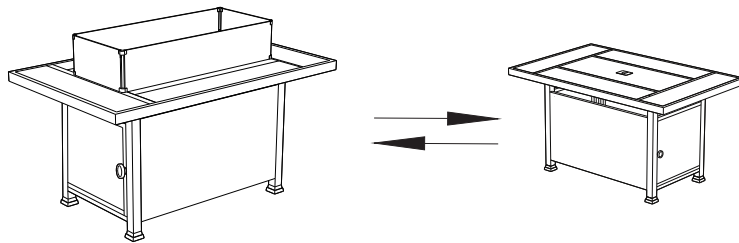

CAUTION: In case the glass surface breaks:
 - Shut immediately off all burners and any electrical heating element and isolate the appliance from the power supply,
 - Do not touch the appliance surface,
 - Do not use the appliance."

27

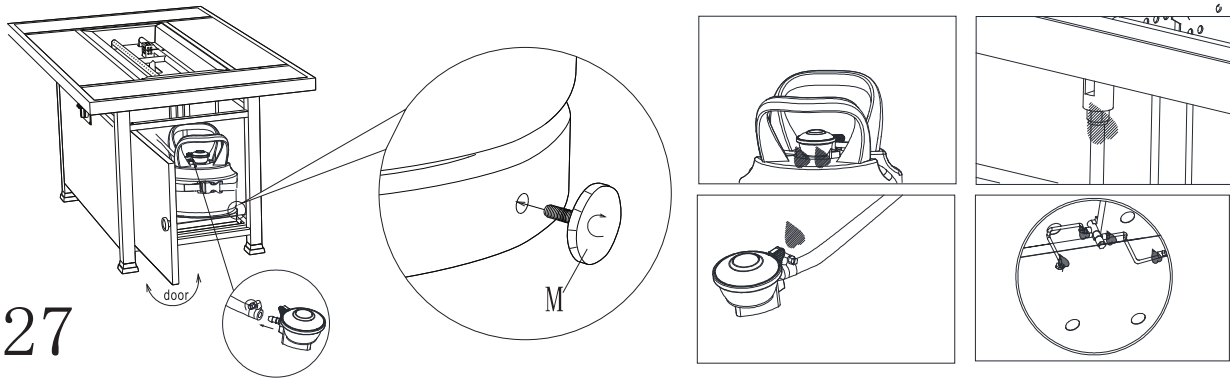

WARNING! Ensure the hose does not come into contact with any high temperature surfaces, or it may melt and leak causing a fire.

After the cylinder is placed inside the heater, secure the cylinder with adjustable belt tightly.

FIRE PIT ASSEMBLY INSTRUCTIONS

NOTE: When the fire pit is NOT in use or after use, when the fire pit has cooled COMPLETELY, cover it with the Burner Cover. Do NOT PUT THE BURNER COVER ON A HOT FIRE PIT.

HEATER STAND AND LOCATION

The heater is for outdoor use only. Always ensure that adequate ventilation is provided.

Always maintain proper clearance to combustibles materials of at least 1 metres.

Do not place near to your house.

Do not place near to shed, garage or fences.

Do not place under roof covering or low overhanging trees

Do not place near to power sources or under overhanging power cables.

Heater must be placed on level firm ground. Ensure that castor wheels are locked into place.

The appliance is fitted 'Overturn Shut Off Device'. If the appliance is tilted or does not stand vertically or was to fall over it will automatically shut off gas supply and appliance would shut down.

Never operate heater in an explosive atmosphere where petroleum or other flammable liquids and gases are stored.

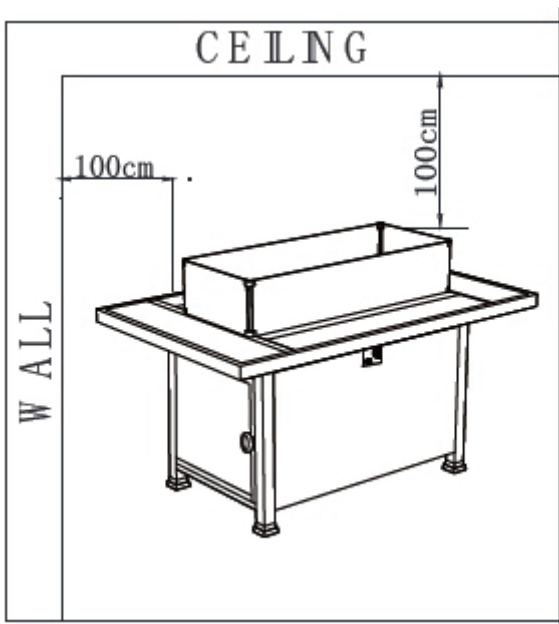

Gas Bottle & Regulator&Hose

The appliance need to work with a regulator with 8-10mm inlet and at least 50cm of gas hose in certain markets. It could be butane, propane or Liquid petroleum gas in certain pressure which is available at garden centres, retailers and gas suppliers.

Please ensure that a suitable regulator with a minimum flow rate capacity of 1.3kg/hr and relevant supply pressure is used. Please contact your local gas supplier for further advice if needed.

The gas hose should be checked regularly to ensure it is in good condition and it is recommended that it is replaced in accordance with standard practices.

Propane or Butane.

Although the heater will work with either propane or butane, there is a difference between the two gasses. Butane cannot be used in temperatures below 5°C, whereas propane can be used all year round. We would recommend propane

Gas cylinder dimension, choose the one which suit the dimension of cylinder cabinet.

1: maximum diameter
2: maximum height



Max diameter: 300mm

Max height: 430mm

Warning!!!

It's extremely important that you DO NOT route the gas hose under the directly under burner. Do not allow the hose to touch any part of the burner or heater. The hose should be located so that it is not subjected to undue strain or placed where it could be damaged.

This appliance must be used, and the gas cylinder stored, in accordance with the regulations in force.

GAS REQUIREMENTS

Use propane or butane gas only.

Always use the correct pressure regulator and hose assembly suitable for the gas cylinder. Contact your local gas supplier for further advice if needed.

Dented, rusted or damaged gas cylinders may be hazardous and should be checked by your gas supplier.

Never use a cylinder with a damaged valve connection.

Never connect an unregulated gas cylinder to the heater.

LEAKAGE TEST

Gas connections on the heater are leak tested at the factory prior to shipment. A complete leakage test should be performed at the installation due to possible mishandling in shipment or excessive pressure being applied to the heater.

Make a soap solution of one part liquid detergent and one part water. The soap solution can be applied with a spray bottle, brush or rag. Soap bubbles will appear in case of a leak.

The heater must be checked with a full cylinder.

Make sure the safety control valve is in the 'OFF' position.

Turn the gas supply from the cylinder ON.

In case of a leak, turn off the gas supply. Tighten any leaking fittings, then turn the gas supply on and recheck.

Never do leak test while smoking.

LIGHTING INSTRUCTIONS

Open the cabinet door and put the gas cylinder into the cabinet.

Make sure to turn the control knob clockwise to "OFF" position.

Connect the regulator to the gas bottle.

Push and turn control knob counterclockwise to "LOW";

Press the igniter button repeatedly to light burner.

If ignition does not occur in 5 seconds, push the burner control knob to "OFF", wait 5 minutes repeat.

Release control knob after 45 seconds,

If igniter does not light burner, use a long match or a long butane lighter;

Adjust flame to desired flame with the control knob

WARNING:

If the burner fails to ignite, turn the control valve knob 'OFF' (clockwise) and turn the gas cylinder valve 'OFF'.

Wait for five minutes before attempting to relight with ignition sequence.

AFTER USE & STORAGE

Turn the control knob on the appliance clockwise to the 'OFF' position.

Turn the gas supply off at the cylinder.

Do not leave the area until flames have fully extinguished.

Children must not be left unattended straight after use as the appliance will still be hot for some time.

Check gas valve for tightness and damage. If damage is suspected this must be changed by a qualified technician.

Always store gas cylinders in well ventilated areas.

Once heater has cooled down it can be moved to alternative location such as garage or shed.

Once heater has cooled down it is safe to use rain cover for protection.

CLEANING & MAINTENANCE

Ensure all cleaning is done whilst heater is turned off and fully cooled down.

Wipe surfaces with a soft, damp cloth.

Do not use any corrosive or combustible cleaning solutions.

Keep the outdoor fire covered when not in use to stop rain from blocking the burner jets.

Make sure burner is kept clean and clear of combustible materials and dirt.

Soot can build up on the glass beads, lava rocks and ceramics logs. This could block burner jets so remove the fuel bed and wipe with damp cloth to clean soot.

Soot can build up on the surrounding safety glass. Carefully remove the glass from glass bracket with relative screwdriver, wipe soot with a soft, damp cloth, then carefully replace. Two people maybe required disassembly and reassembly of the surrounding safety glass.

Ensure the condition of gas hose is suitable and shows no signs of cracking or general wear & tear.

It is advised to get the appliance check by a qualified technician every 3 years.

If the burner jets do get blocked by soot or other dirt then remove the fuel bed and use a pin or paperclip.

Ensure the burner is switched

Follow the above maintenance steps on a regular basis.

TROUBLESHOOTING

Problem:	Condition:	Solution suggested:
Burner won't light	Control knob is not in Maximum position (big flame).	Turn control knob in Maximum position (big flame).
	LPG cylinder valve is closed / Empty.	Open the valve / Replace LPG cylinder with a new one.
	Blockage in the injector.	Clean or replace injector.
	Air in the gas circuit.	Open gas line and bleed it (pressing control knob in) for not over 1 minute or until you smell gas.
	Low gas pressure.	Replace LPG cylinder with a new one.
Burner won't stay lit	Igniter fails.	Use match to light burner; change battery or obtain new igniter and replace it.
	Dirty build up around burner.	Clean dirty around the burner.
	Low flames or not full running around the burner.	Flame spreader holes partially closed; clean the burner.
	Thermocouple is not operating correctly.	Replace thermocouple (FSD).
Burner flame is low Note: Do not operate appliance below 5 °C	Low Gas pressure.	Replace LPG cylinder with a new one.
	Outdoor temperature is greater than 5 °C and LPG cylinder is less than 25 % full.	Replace LPG cylinder with a new one.
	Gas pipe is bent or kinked.	Straighten hose and perform leakage test on gas pipe.
Carbon build-up	Control knob is fully Maximum position (big flame).	Turn control knob to "OFF" position (full disk), let cool to room temperature and check burner and orifices for blockage.
Flash back (flame inside burner)	Dirty or film on burner.	Clean burner.
Thick black smoke	Burner ports are blocked.	Switch OFF the appliance. Close LPG cylinder valve. Wait 2 minutes, following the ignition procedure. Ignite burner. If problem continuous, switch-off. Contact your dealer.
	Blockage in the burner.	Turn control knob to "OFF" position, let the appliance to cool at room temperature and remove blockage and clean burner inside and outside.

Warning:

What to do after glass on heaters broken:

- a. If the heater is not in use, please don't touch splinters with hands, clean all splinters with tools to avoid anybody be injured. And ask a professional man for installation of new glass.
- b. When it happened in use, please turn off the cylinder and control valve immediately, clean all splinters with tools to avoid anybody be injured. And ask a professional man for installation of new glass.

CAUTION: In case the glass surface breaks:

- shut immediately off all burners and any electrical heating element and isolate the appliance from the power supply,
- do not touch the appliance surface,
- do not use the appliance.

CONTACT

If you have any questions, please contact our customer care center.

Our contact details are below:



0044-800-240-4004



enquiries@mhstar.co.uk

IMPORTER ADDRESS:
MH STAR UK LTD
Unit 27, Perivale Park,
Horsenden lane South
Perivale, UB6 7RH
MADE IN CHINA

Manufacture: JIANGSU XINYI OUTDOOR FURNITURE CO., LTD.

Address: Shaodian Industrial Park, XinYi ,Xuzhou City, JiangSu Province, China.

Contact: 0086-516-81603333

Fax: 0086-516-88690999

Mail: xyhw@js-fullcare.com