

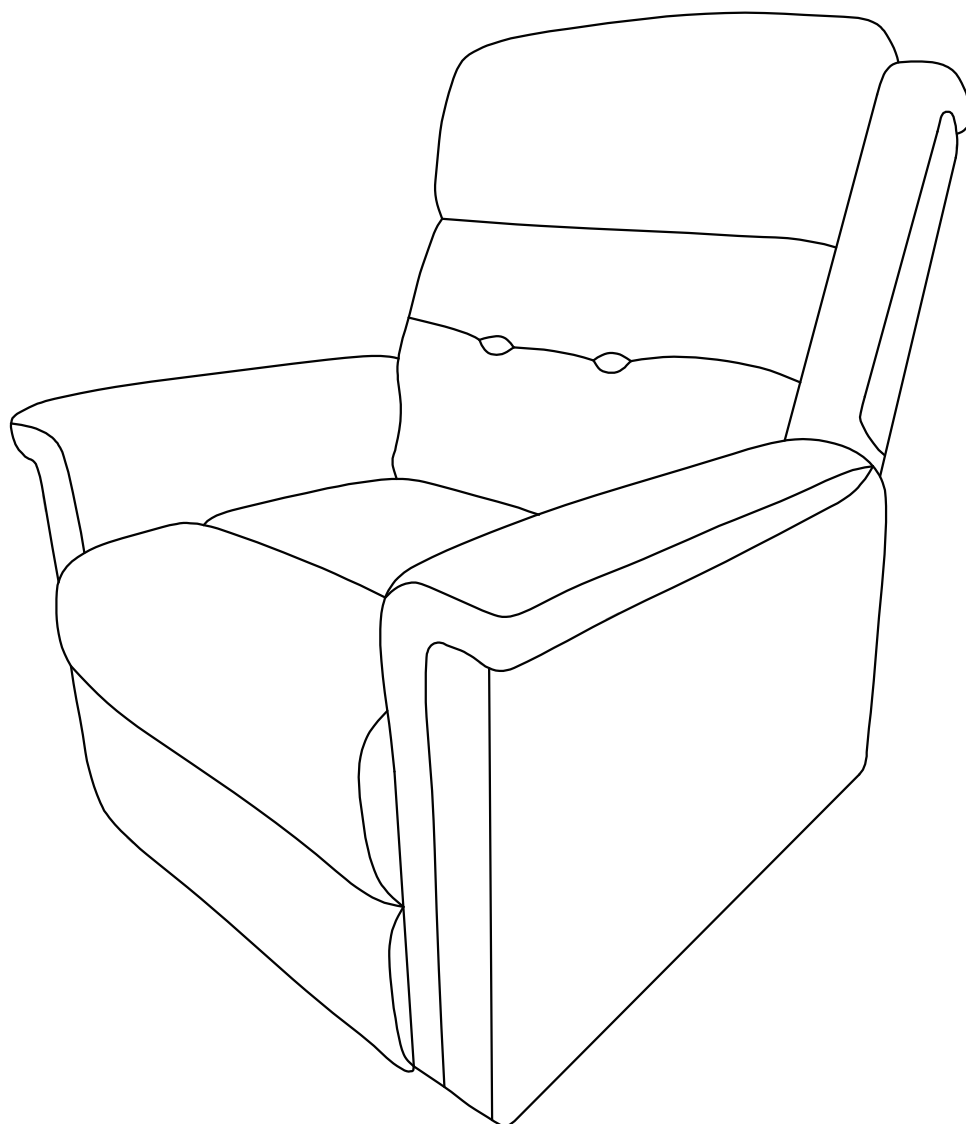

IN231200253V01\_FR\_DE\_IT

**713-133V90\_713-133V91**



**EN\_IMPORTANT, RETAIN FOR FUTURE REFERENCE: READ CAREFULLY.**

**FR\_IMPORTANT: A LIRE ATTENTIVEMENT ET A CONSERVER POUR VOUS Y REFRERER  
ULTERIEUREMENT**

**DE\_WICHTIG! SORFGFÄLTIG LESEN UND FÜR SPÄTERES NACHSCHLAGEN AUFBEWAHREN.**

**IT\_IMPORTANTE, LEGGERE E CONSERVARE QUESTO MANUALE D'ISTRUZIONE PER UN USO  
FUTURO.**

# **IMPORTANT, RETAIN FOR FUTURE REFERENCE: READ CAREFULLY.**

## **Only for domestic use**

### **Instructions for use:**

- \*Put the chair stably on a flat floor.
- \*Stay away from open flames.
- \*Avoid the overload at the chair.

### **Precautions before assembly:**

- \*Prepare a clean and dry mounting area.
- \*Verify that the product is not damaged.
- \*Check that none of the pieces are missing.

### **Maintenance:**

- \*Clean with a soft fabric.
- \*Check the seating regularly.

### **Storage conditions:**

- \*The fabric should be stored completely dry, in a clean and dry place to avoid the risks of mold.

## **Beware of crushing and cutting hazards during assembly.**

**The manufacturer declines all responsibility in case of damages due to a bad installation or withering.**

**If the seating is fitted with powered seat height adjustments, only trained personnel may replace or repair those components.**

# **IMPORTANT: A LIRE ATTENTIVEMENT ET À CONSERVER POUR CONSULTATION ULTÉRIEURE.**

## **Réservé à un usage domestique**

### **Conseils :**

- \*Placez la chaise sur un sol plat et sec afin qu'elle soit stable
- \*Placer à l'écart des flammes ou de sources de chaleur
- \*Ne pas dépasser la charge maximale autorisée

### **Précautions avant l'assemblage :**

- \*Préparez une zone de montage propre et sèche
- \*Vérifiez que le produit n'est pas endommagé
- \*Vérifiez qu'aucune des pièces de ne manque

### **Recommandations d'entretien :**

- \*Veuillez utiliser un chiffon doux pour essuyer la chaise
- \*Vérifiez régulièrement la structure du produit

### **Conditions de stockage:**

- \*Veuillez stocker le produit dans un environnement propre et sec pour éviter tout risque de moisissure.

**Veillez faire attention à ne pas vous blesser lors de l'assemblage du produit.**

**Le fabricant n'est pas responsable des dommages causés par une mauvaise installation.**

**Si le fauteuil est équipé d'un dispositif de hauteur réglable avec moteur, seule une personne qualifiée peut remplacer ou réparer la partie motorisée.**

# **WICHTIG! SORGFÄLTIG LESEN UND ZUM SPÄTEREN NACHSCHLAGEN AUFBEWAHREN.**

## **Ausschließlich für den häuslichen Gebrauch bestimmt Nutzungshinweise:**

- \*Bitte stellen Sie den Stuhl stabil auf eine ebene Fläche.
- \*Von offenen Feuerquellen fernhalten.
- \*Vermeiden Sie eine Überlastung des Stuhls.

## **Vorsichtsmaßnahmen vor der Montage:**

- \*Bitte bereiten Sie einen sauberen und trockenen Montagebereich vor.
- \*Stellen Sie sicher, dass das Produkt nicht beschädigt ist.
- \*Vergewissern Sie sich, dass kein Zubehörteil fehlt.

## **Instandhaltung:**

- \*Bitte reinigen Sie den Stuhl nur mit einem weichen Tuch.
- \*Überprüfen Sie den Stuhl regelmäßig.

## **Lagerung:**

- \*Der Stoff sollte an einem völlig trockenen und sauberen Ort aufbewahrt werden, um Schimmel zu vermeiden.

## **Vorsicht vor Quetsch- und Schnittgefahr bei der Montage.**

**Der Hersteller lehnt jegliche Haftung für Schäden ab, die aufgrund unsachgemäßer Montage oder Witterungseinflüsse verursacht werden. Falls der Stuhl mit einer elektronischen Höhenverstellung geliefert wird, dürfen Reparaturarbeiten nur von qualifiziertem Personal durchgeführt werden.**

# **IMPORTANTE! CONSERVARE IL PRESENTE MANUALE PER FUTURO RIFERIMENTO E LEGGERLO ATTENTAMENTE.**

## **Solo per uso domestico**

### **Istruzioni per l'uso:**

- \*Posizionare la sedia in maniera stabile su un pavimento in piano.
- \*Tenere lontano dalle fiamme vive.
- \*Evitare di sovraccaricare la sedia.

### **Precauzioni prima del montaggio:**

- \*Preparare un'area di montaggio sgombra e asciutta.
- \*Verificare che il prodotto non sia danneggiato.
- \*Verificare che non manchi nessun pezzo.

### **Manutenzione:**

- \*Pulire con un tessuto morbido.
- \*Controllare regolarmente il sedile.

### **Condizioni di stoccaggio:**

- \*Il tessuto deve essere conservato completamente asciutto, in un luogo pulito e asciutto per evitare la formazione di muffa.

### **Fare attenzione al rischio di schiacciamento e di taglio durante le fasi di montaggio.**

**Il produttore declina ogni responsabilità in caso di danni dovuti ad un'installazione incorretta o alle intemperie.**



**Se la sedia è dotata di un'unità di regolazione elettrica dell'altezza del sedile, solo il personale qualificato può sostituire o riparare questi componenti elettrici.**

# PACKING DETAILS: TOTAL 2 BOXES

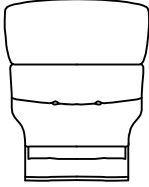
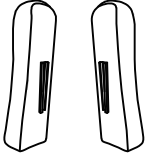
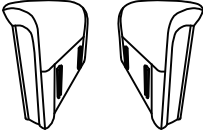
## BOX 1/2

PART NO.	PARTS	QTY
(1)		X1
(2) LR		X2
(3) LR		X2

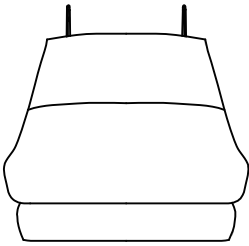
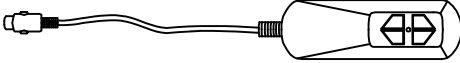
## BOX 2/2

PART NO.	PARTS	QTY
(4)		X1
(5)		X1
(6)		X1
(7)		X1

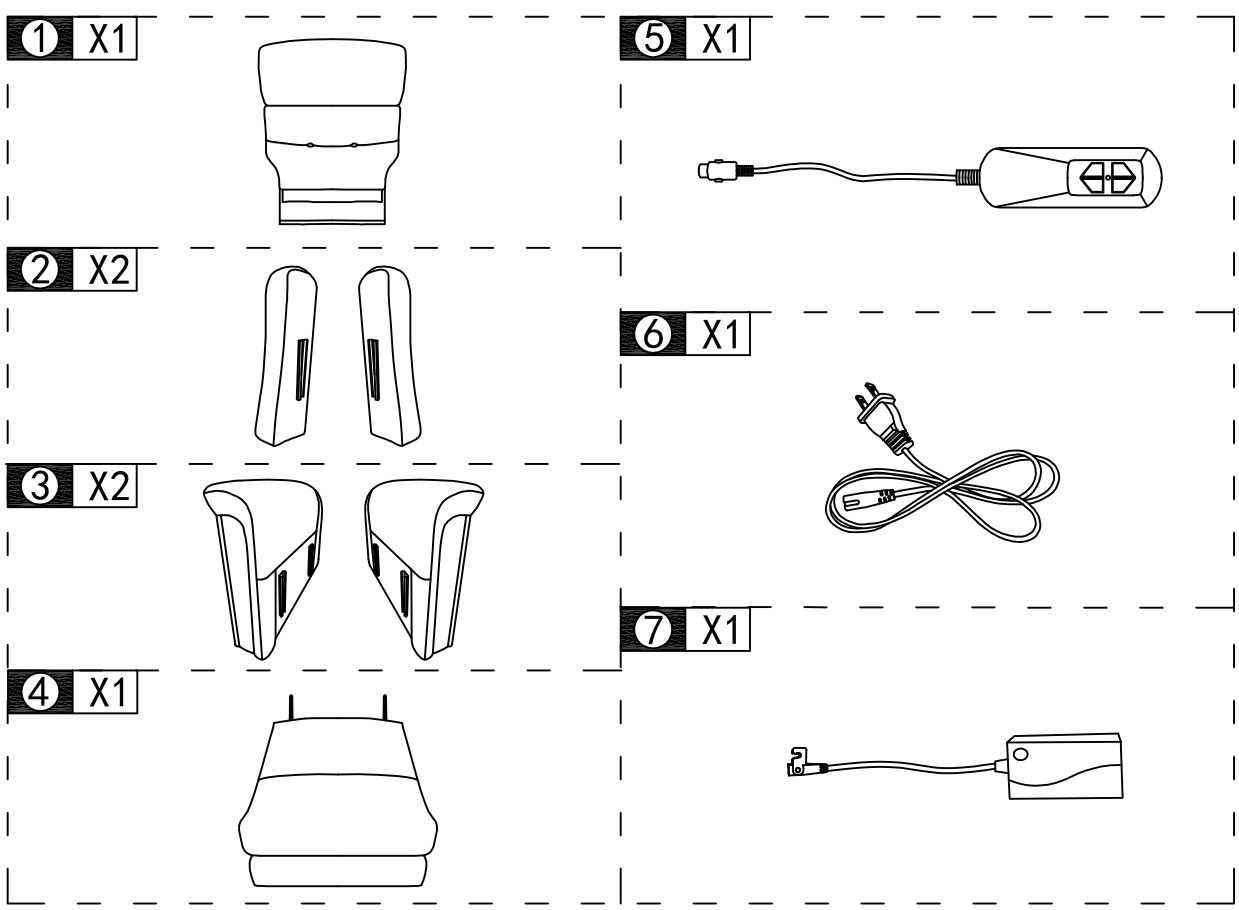

- 3 X2
- 4 X1

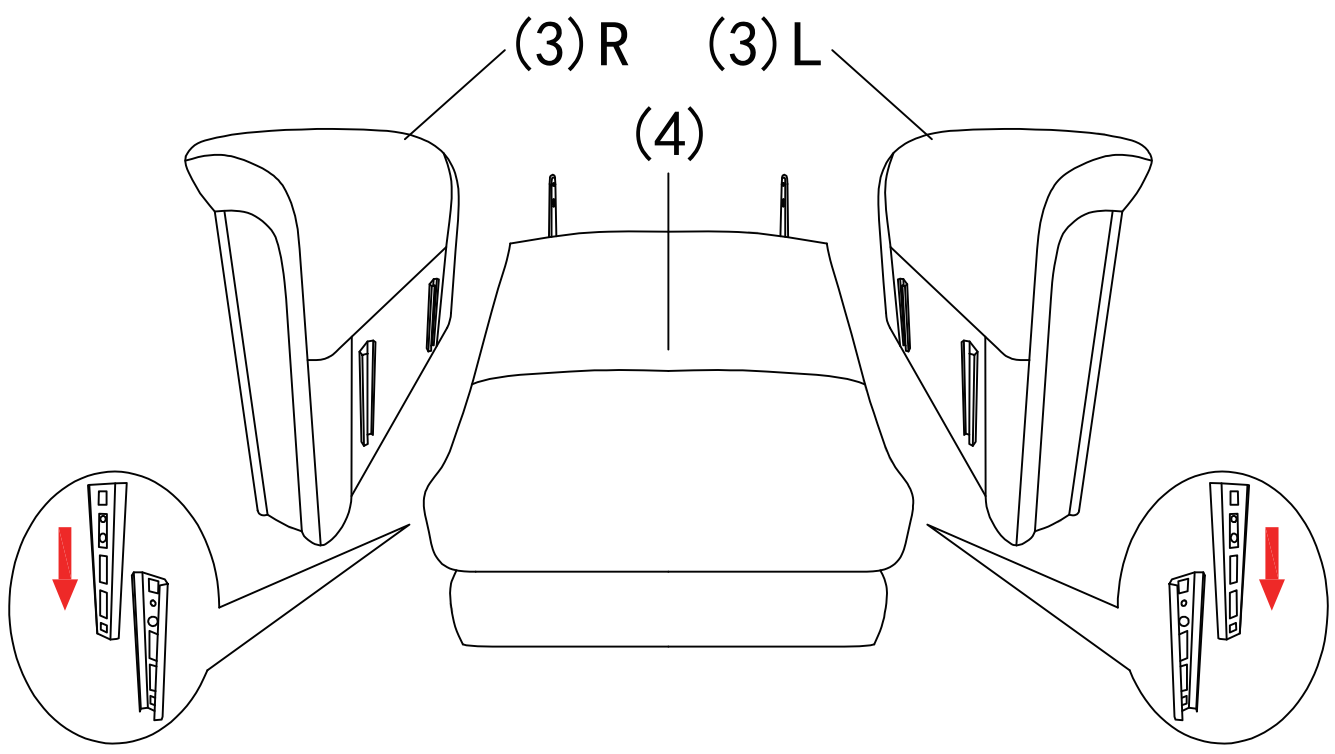

1 X1

(1)

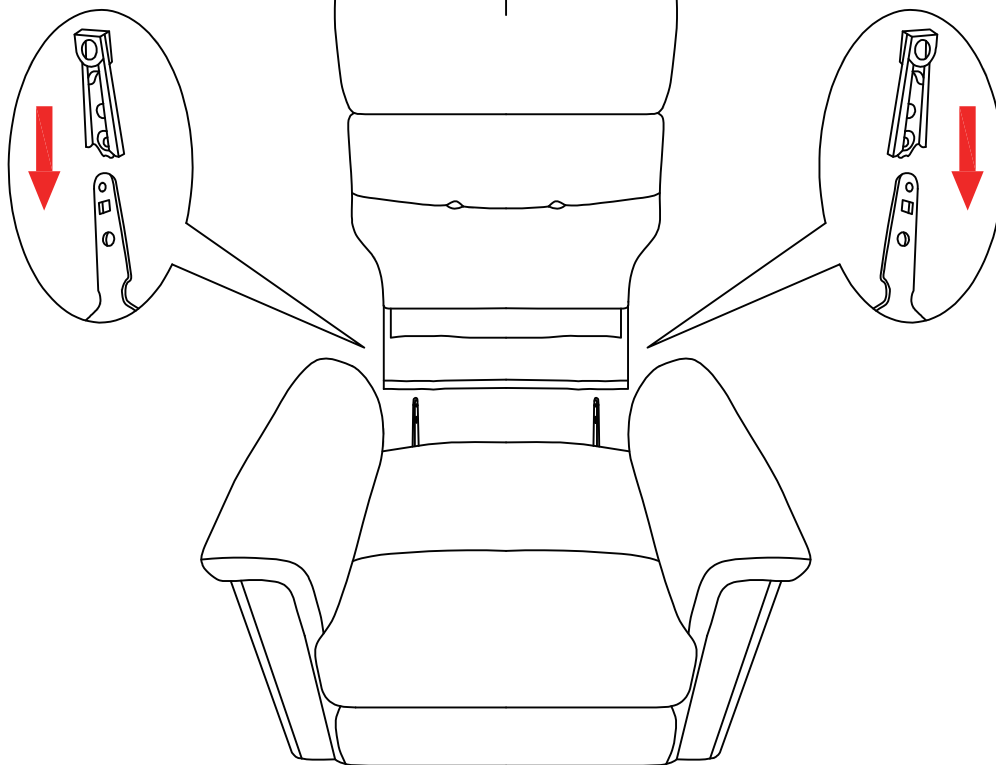

2 X2

(2) R (2) L

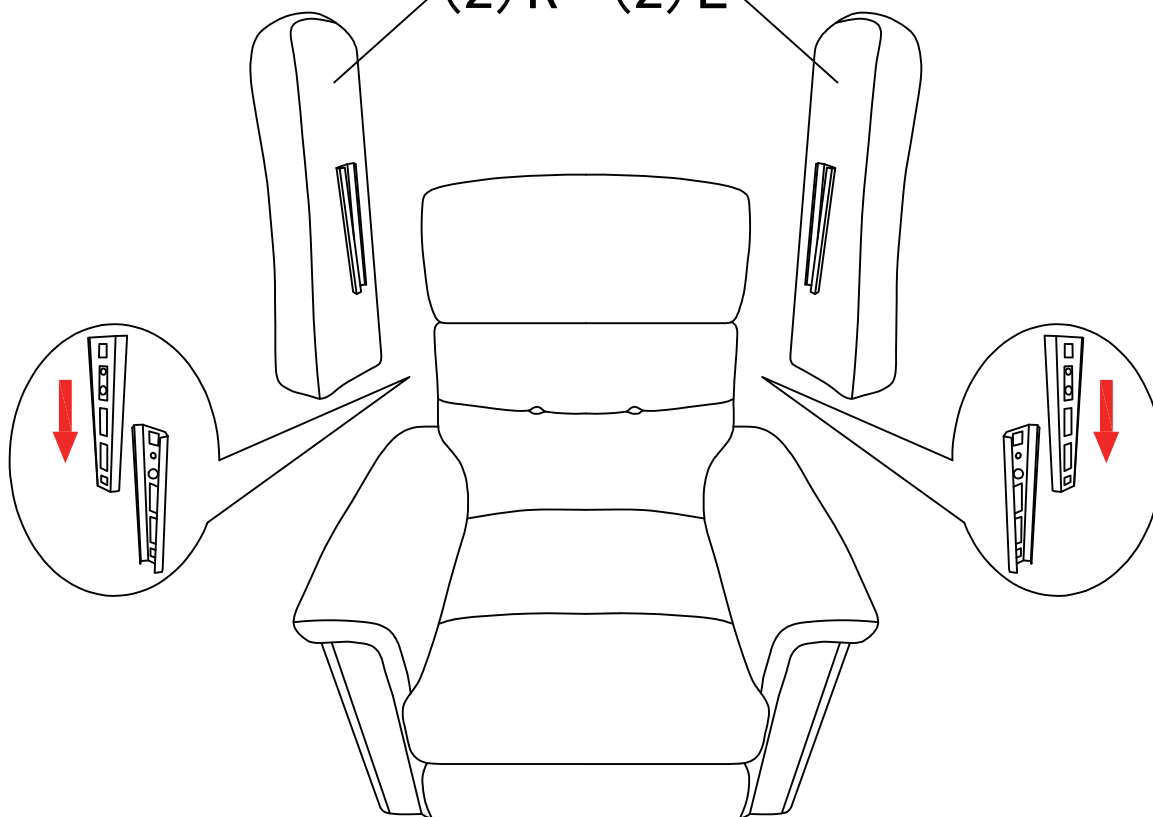



5 X1



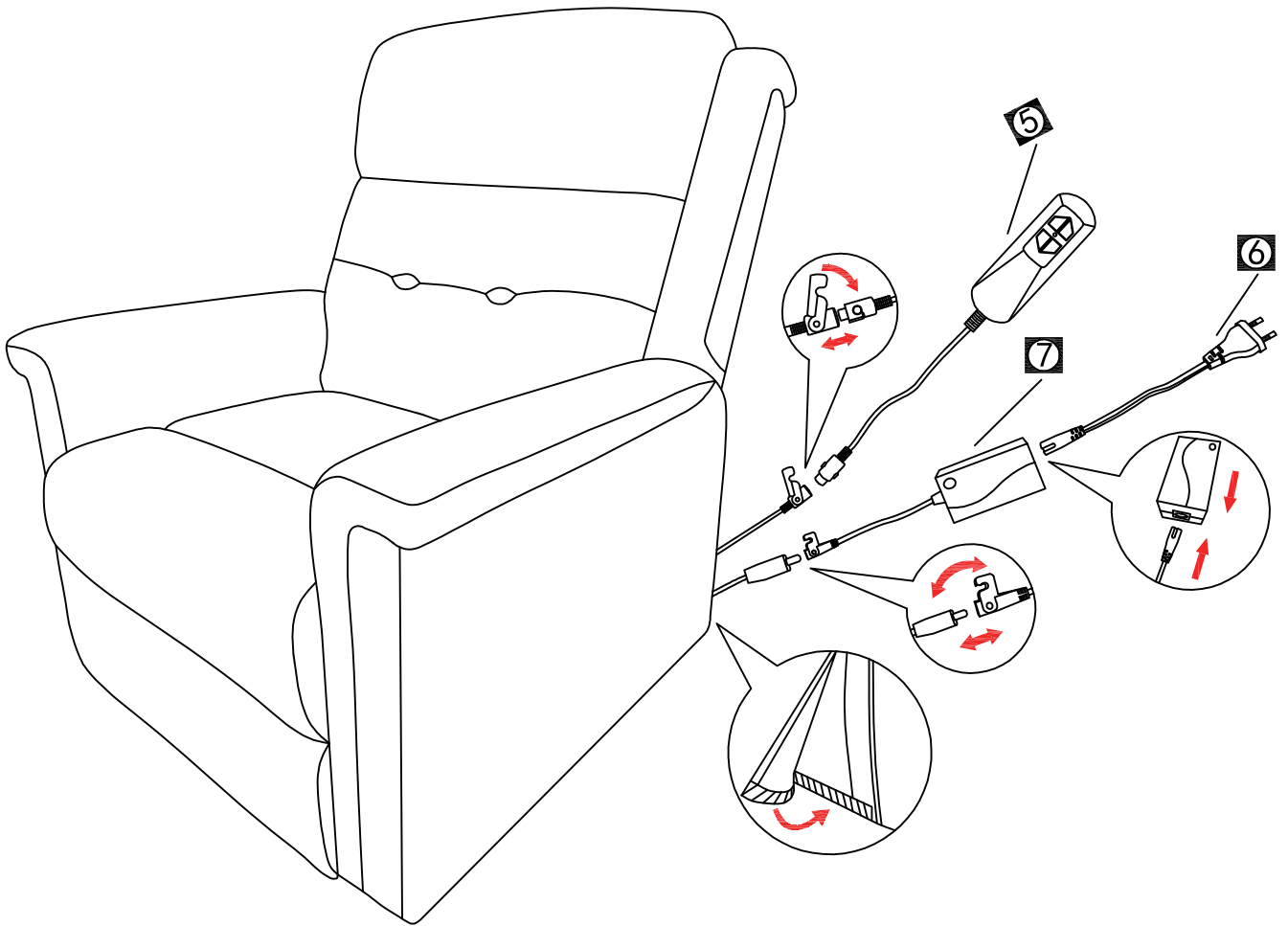

6 X1

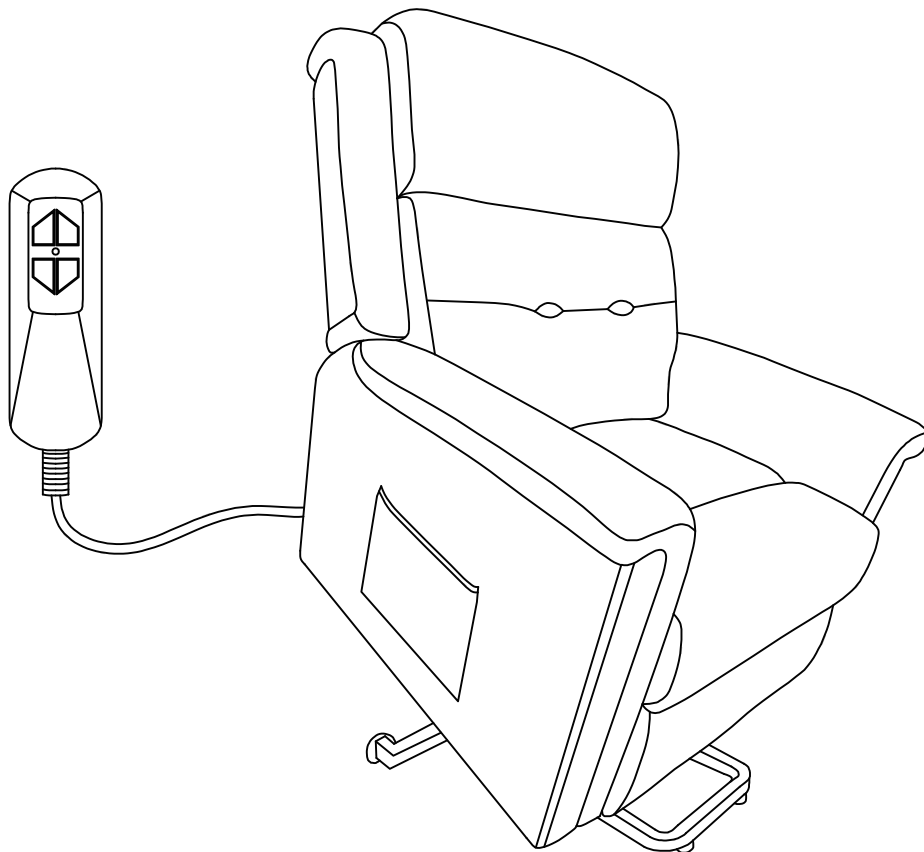
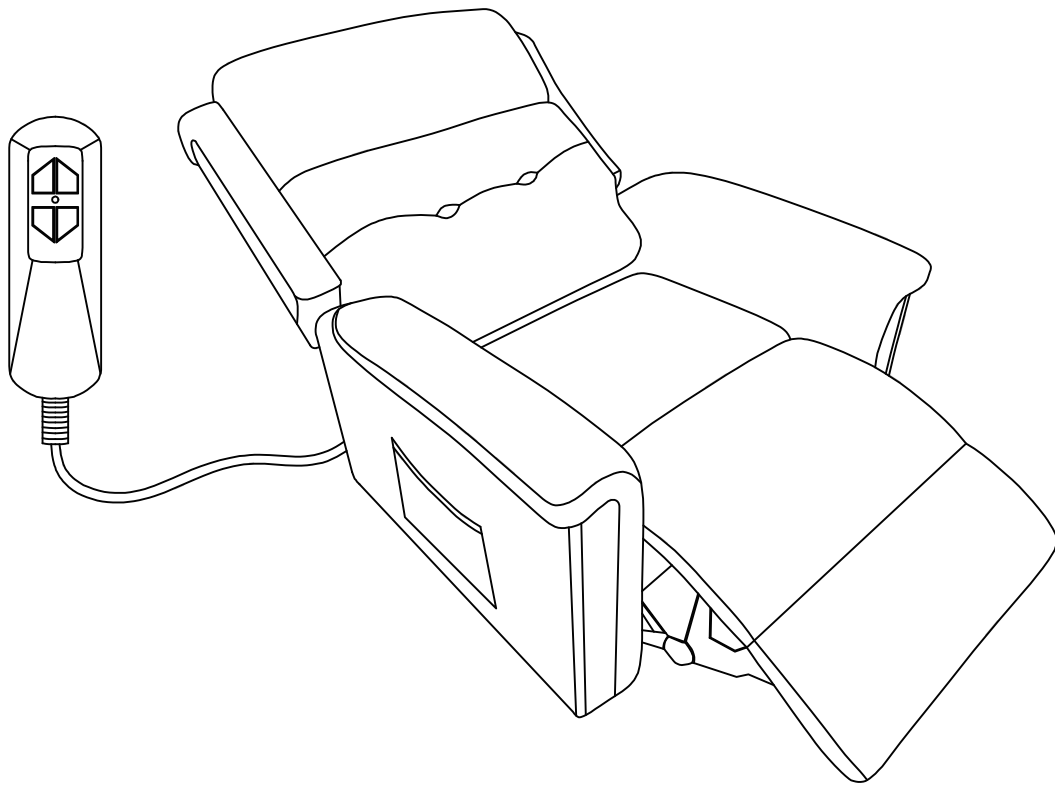
7 X1





# I. Fonction de levage et inclinable

1.  Abaissez le dossier
2.  Soulevez dossier
3.  Ouvrez le repose-pied
4.  Fermez le repose-pied.

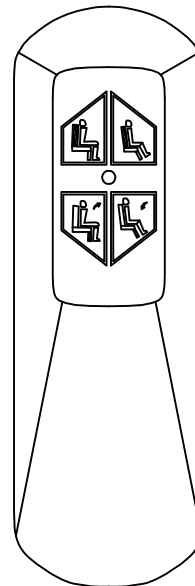





**Avertissement:**

N'appuyez jamais sur les deux boutons ensemble, car cela endommagerait votre fauteuil.

Ne vous levez jamais pendant que le fauteuil fonctionne encore afin d'éviter tout accident.

# I.Hebe- und Liegefunktion

1.  Absenken der Rückenlehne
2.  Hochklappen der Rückenlehne
3.  Öffnet die Fußstütze.
4.  Schließt die Fußstütze.

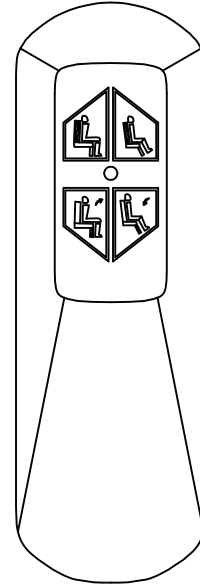





## Achtung:

Drücken Sie niemals beide Tasten gleichzeitig, da dies Ihren Stuhl beschädigen kann.

Stehen Sie niemals auf, wenn der Stuhl noch in Betrieb ist, um einen Unfall zu vermeiden.

# I. Funzioni di sollevamento e reclinamento

1.  Abbassa lo schienale
2.  Solleva lo schienale
3.  Estende il poggiapiedi.
4.  Ripiega il poggiapiedi.

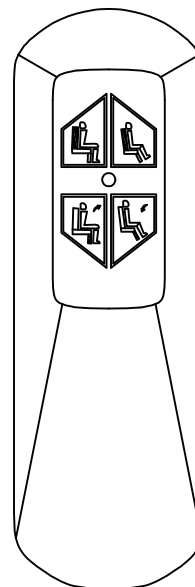





## Avvertenza:

Non premere mai entrambi i pulsanti contemporaneamente in quanto ciò danneggerebbe la poltrona.

Non alzarsi mai in piedi mentre la poltrona è ancora in funzione per evitare incidenti.

# I . Lfit and Recliner Function

1.  Lower the backrest.
2.  Up the backrest.
3.  Opens footrest.
4.  Closes footrest.

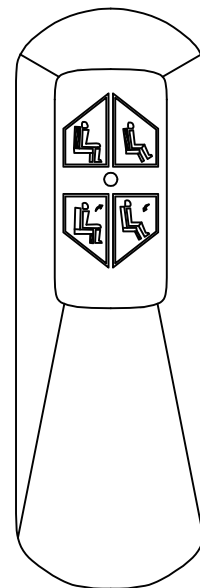

## Warning:

Never press both buttons together as this will damage your chair.

Never stand up while the chair is still working in order to avoid an accident.

115V

230V

	115V	230V	
Model:	YH-A290020-A	YH-A290020-A	
Input voltage	100-240	100-240	V
Input AC frequency	50-60	50-60	Hz
Output voltage	29	29	V
Output current	2.0	2.0	A
Output power	58	58	W
Average active efficiency	88.21%	88.43%	%
Efficiency at low load (10 %)	88.21%	88.43%	%
No-load power consumption	0.041	0.112	W



FR

Pensez à  
donner ou recycler.



Association

ou



Magasin

ou



Déchèterie

<https://quefairedemesdechets.fr>

**UK**

If you have any questions, please contact our customer care center.

Our contact details are below:



0044-800-240-4004



enquiries@mhstar.co.uk

**IMPORTER ADDRESS:**

MH STAR UK LTD

Unit 27, Perivale Park,

Horsenden lane South

Perivale, UB6 7RH

MADE IN CHINA

**ES**

Si tiene alguna pregunta, comuníquese con nuestro Centro de Atención al Cliente. Nuestros datos de contacto son los siguientes:



0034-931294512



atencioncliente@aosom.es

**IMPORTADOR:**

SPANISH AOSOM, S.L.

C/ ROC GROS, N° 15. 08550, ELS HOSTALETS DE

BALENYÀ, SPAIN.

B66295775

WWW.AOSOM.ES

ATENCIONCLIENTE@AOSOM.ES

TEL: 931294512

HECHO EN CHINA

**FR**

Si vous avez la moindre question, veuillez contacter notre centre d'assistance à la clientèle.

Nos coordonnées sont les suivantes:



0033-1-84166106



aosom@mhfrance.fr

**Importé par:**

MH France

2, rue Maurice Hartmann

92130 Issy-les-Moulineaux

France

Fabriqué en Chine

**PT**

Se tiver alguma dúvida, por favor contacte o nosso Centro de Atendimento ao Cliente. Os nossos dados de contacto são os seguintes:



0034-931294512



info@aosom.pt.

**IMPORTADOR:**

SPANISH AOSOM, S.L

C.ROC GROS N.15, 08550. ELS HOSTALETS DE BALENYÀ

TEL: 931294512 (SEG-SEX DAS 7:30H ÀS 16:30H)

INFO@AOSOM.PT

WWW.AOSOM.PT

**DE**

Wenn Sie Fragen haben, wenden Sie sich bitte an unser Kundendienstzentrum.

Unsere Kontaktdaten stehen unten:



0049-0(40)-88307530



service@aosom.de

**ADRESSE DES IMPORTEUR:**

MH Handel GmbH

Wendenstraße 309

D-20537 Hamburg

Germany

IN CHINA HERGESTELLT

**IT**

In caso di dubbio, si prega di contattare il nostro centro assistenza clienti. I nostri dettagli di contatto sono di seguito:



0039-0249471447



clienti@aosom.it

**IMPORTATO DA:**

AOSOM Italy srl

Centro Direzionale Milanofiori

Strada 1 Palazzo F1

20057 Assago (MI)

P.I.: 08567220960

FATTO IN CINA