

AIYAPLAY

IN240200157V01_UK_DE_FR_IT_ES_PT

312-112V80

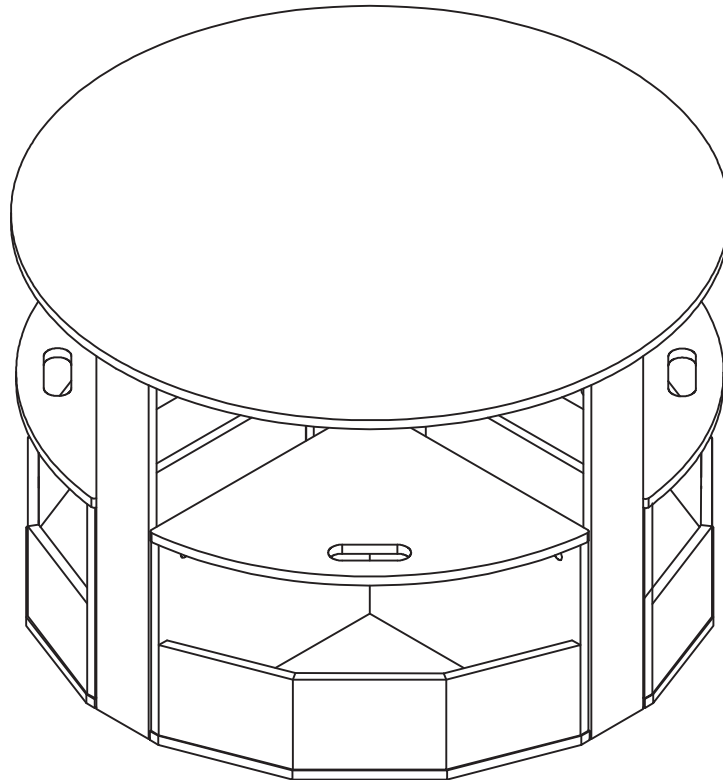

EN: **WARNING:** Suitable for ages 3+ years;
Maximum Weight Capacity of Chair: 20 Kg/seat; Table: 30 Kg.
DE: **WARNUNG:** Geeignet für Kinder im Alter von 3+ Jahren;
Maximale Gewichtskapazität des Stuhls: 20 Kg/Sitzplatz; Tisches: 30 kg.
FR: **ATTENTION:** Convient aux enfants de 3+ ans;
Poids maximum admissible de la chaise: 20 Kg/siège; Table: 30 kg.
IT: **ATTENZIONE:** Adatto a bambini di 3+ anni;
Capacità massima della sedia: 20 Kg/posto; Tavolo: 30 Kg.
ES: **ADVERTENCIA:** Adecuado para los niños de 3+ años;
Capacidad máxima de peso de la silla: 20 Kg/asiento; Mesa: 30 Kg.
PT: **AVISO:** Idade de certificação: 3+ anos;
Peso máximo de carga (cadeira): 20kgs; Peso máximo de carga (mesa): 30kgs.

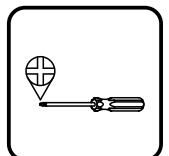
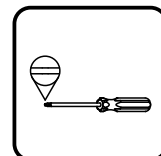
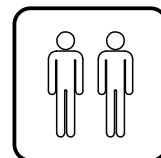

EN_IMPORTANT, RETAIN FOR FUTURE REFERENCE: READ CAREFULLY.

DE_WICHTIG! SORFGFÄLTIG LESEN UND FÜR SPÄTERES NACHSCHLAGEN AUFBEWAHREN.

FR_IMPORTANT: A LIRE ATTENTIVEMENT ET A CONSERVER POUR VOUS Y REFRERER ULTERIEUREMENT

IT_IMPORTANTE, LEGGERE E CONSERVARE QUESTO MANUALE D'ISTRUZIONE PER UN USO FUTURO.

ES_IMPORTANTE, LEA DETENIDAMENTE Y GUARDE PARA FUTURAS REFERENCIAS.

PT_IMPORTANTE, GARDE PARA FUTURA REFERÊNCIA, LEIA ATENTAMENTE.

IMPORTANT! READ CAREFULLY AND KEEP FOR FUTURE REFERENCE.

WARNING:

1. CHOKING HAZARD—Small parts. Not for children under 3 years.
2. Only allowed for adults to install, keep children away.
3. To be used under the direct supervision of an adult.
4. Place it on a flat and clean floor, Check all the parts are well connected before use.
5. DO NOT place this product near a window as it can be used as a step by the child and cause the child to fall out of the window.
6. Be aware of the risk of open fires and other sources of strong heat in the vicinity of the product.
7. DO NOT place this product near a window where cords from blinds or curtains could strangle a child.
8. DO NOT to use the seating if any part is broken, torn or missing and use only spare parts approved by the manufacturer.

MAINTENANCE & CARE

- A. Keep all instructions and parts relating to this product for future reference.
- B. Please wipe down with a dry or damp cloth.

WICHTIG! SORGFÄLTIG LESEN UND ZUM SPÄTEREN NACHSCHLAGEN AUFBEWAHREN.

WARNUNG:

1. ERSTICKUNGSGEFAHR-Kleine Teile. Nicht für Kinder unter 3 Jahren geeignet.
2. Die Montage darf nur von Erwachsenen vorgenommen werden, halten Sie Kinder fern.
3. Es ist unter der direkten Aufsicht eines Erwachsenen zu verwenden.
4. Stellen Sie es auf einen flachen und sauberen Boden. Prüfen Sie, ob alle Teile vor der Verwendung gut verbunden sind.
5. Stellen Sie dieses Produkt NICHT in der Nähe eines Fensters auf, da es vom Kind als Stufe verwendet werden und das Kind dadurch aus dem Fenster fallen kann.
6. Seien Sie sich der Gefahr von offenem Feuer und anderen starker Wärmequellen nahe des Produkts bewusst.
7. Stellen Sie dieses Produkt NICHT in der Nähe eines Fensters auf, wo die Schnüre von Jalousien oder Vorhängen ein Kind erdrosseln könnten.
8. Verwenden Sie den Sitz NICHT, wenn ein Teil gebrochen ist, gerissen ist oder fehlt und verwenden Sie nur vom Hersteller zugelassene Ersatzteile.

WARTUNG & PFLEGE

- A. Bewahren Sie alle Anweisungen und Teile, die sich auf dieses Produkt beziehen, zur späteren Verwendung auf.
- B. Bitte wischen Sie es mit einem trockenen oder feuchten Tuch ab.

IMPORTANT! LIRE ATTENTIVEMENT ET CONSERVER POUR RÉFÉRENCE ULTÉRIEURE.

AVERTISSEMENT:

1. RISQUE D'ÉTOUFFEMENT - Petites pièces. Déconseillé aux enfants de moins de 3 ans.
2. Installation par des adultes uniquement, tenir les enfants à l'écart.
3. À utiliser sous la surveillance directe d'un adulte.
4. Posez-le sur un sol plat et propre. Vérifiez que toutes les pièces sont bien connectées avant toute utilisation.
5. NE PAS placer ce produit près d'une fenêtre ; il pourrait être utilisé comme marchepied par un enfant et le faire tomber par la fenêtre.
6. Soyez conscient du risque de feu ouvert et d'autres sources de forte chaleur à proximité du produit.
7. NE PAS placer ce produit près d'une fenêtre où les cordons des stores ou des rideaux pourraient étrangler un enfant.
8. NE PAS utiliser le siège si une pièce est cassée, déchirée ou manquante et n'utiliser que des pièces de rechange approuvées par le fabricant.

ENTRETIEN ET MAINTENANCE

- A. Conservez toutes les instructions et les pièces relatives à ce produit pour pouvoir vous y référer ultérieurement.
- B. Veuillez essuyer avec un chiffon sec ou humide.



Adresses sur quefairedemesdechets.fr

IMPORTANTE! LEGGERE ATTENTAMENTE E CONSERVARE PER RIFERIMENTO FUTURO.

AVVERTENZE:

1. RISCHIO DI SOFFOCAMENTO — Parti piccole. Non adatte a bambini sotto i 3 anni.
2. Consentito solo agli adulti di installare, tenere lontani i bambini.
3. Da utilizzare sotto la diretta supervisione di un adulto.
4. Posizionarlo su una superficie piana e pulita, controllare che tutte le parti siano connesse correttamente prima dell'uso.
5. NON posizionare il prodotto vicino a una finestra, poiché potrebbe essere utilizzato come gradino dal bambino e causarne la caduta dalla finestra.
6. Stare attento al rischio di fuochi e di altre fonti di forte calore nelle vicinanze del prodotto.
7. NON posizionare il prodotto vicino a una finestra dove le corde delle tende o delle tapparelle potrebbero strangolare il bambino.
8. NON utilizzare il seggiolino se qualche parte è rotta, strappata o mancante e utilizzare solo ricambi approvati dal produttore.

MANUTENZIONE & CURA

- A. Conservare tutte le istruzioni e le parti relative a questo prodotto per riferimenti futuri.
- B. Si prega di pulire passando un panno asciutto o inumidito.

¡IMPORTANTE! LEA CUIDADOSAMENTE Y GUARDE PARA LAS REFERENCIAS FUTURAS.

ADVERTENCIA:

1. PELIGRO DE ASFIXIA: Incluidas piezas pequeñas. No es adecuado para los niños menores de 3 años.
2. La instalación sólo se puede realizar por los adultos, mantenga a los niños alejados al instalar el producto.
3. El producto debe ser utilizado bajo la supervisión directa de un adulto.
4. Colóquelo sobre un piso plano y limpio. Verifique si todas las piezas estén conectadas adecuadamente antes de utilizarlo.
5. NO coloque este producto cerca de ventanas, de lo contrario, los niños pueden utilizarlo como un escalón y hacer que se caigan por la ventana.
6. Tenga en cuenta el riesgo de llamas abiertas y otras fuentes de calor intenso cerca del producto.
7. NO coloque este producto cerca de ventanas, ya que los cordones de las persianas o las cortinas puedan estrangular a los niños.
8. NO utilice el asiento si alguna pieza está dañada, rasgada o faltante, y utilice únicamente los repuestos aprobados por el fabricante.

MANTENIMIENTO Y CUIDADO

- A. Guarde todas las instrucciones y piezas relativas juntas con este producto para las referencias futuras.
- B. Límpielo con un paño seco o humedecido.









IMPORTANTE! LER ATENTAMENTE E GUARDAR PARA REFERÊNCIA FUTURA.

ADVERTÊNCIA:

1. PERIGO DE ASFIXIA: Incluí peças pequenas. Não adequado para crianças com menos de 3 anos de idade.
2. A instalação só pode ser realizada por adultos, manter as crianças afastadas quando estiver a instalar do produto.
3. O produto deve ser utilizado sob a supervisão directa de um adulto.
4. Colocá-lo sobre um chão plano e limpo. Verificar se todas as peças estão devidamente conectadas antes da sua utilização.
5. NÃO coloque este produto perto de janelas, caso contrário as crianças podem usá-lo como um degrau e fazê-las cair da janela.
6. Estar consciente do risco de chamas abertas e outras fontes de calor intenso perto do produto.
7. NÃO coloque este produto perto de janelas, pois os cordões das persianas ou cortinas podem sufocar as crianças.
8. NÃO utilizar o assento se alguma peça estiver danificada, rasgada ou em falta, e utilizar apenas peças de substituição aprovadas pelo fabricante.

MANUTENÇÃO E CUIDADOS

- A. Manter todas as instruções e peças relacionadas com este produto em guardadas para referência futura.
- B. Limpar com um pano seco ou húmido.

| | | | | |
|---|--|--|---|---|
| <p>A</p>  <p>Ø12x10mm</p> <p>+1(spare) x60</p> | <p>B</p>  <p>Ø6.5 x 38mm</p> <p>+1(spare) x44</p> | <p>C</p>  <p>Ø6 x 30mm</p> <p>+1(spare) x36</p> | <p>D</p>  <p>+1(spare) x8</p> | <p>E</p>  <p>12x30mm</p> <p> x 4</p> |
| <p>F</p>  <p>M4x30mm</p> <p>+1(spare) x28</p> | <p>G</p>  <p>Ø25mm</p> <p>+1(spare) x12</p> | <p>H</p>  <p>M4x25mm</p> <p>+1(spare) x8</p> | | |

EXPLOSION FIGURE

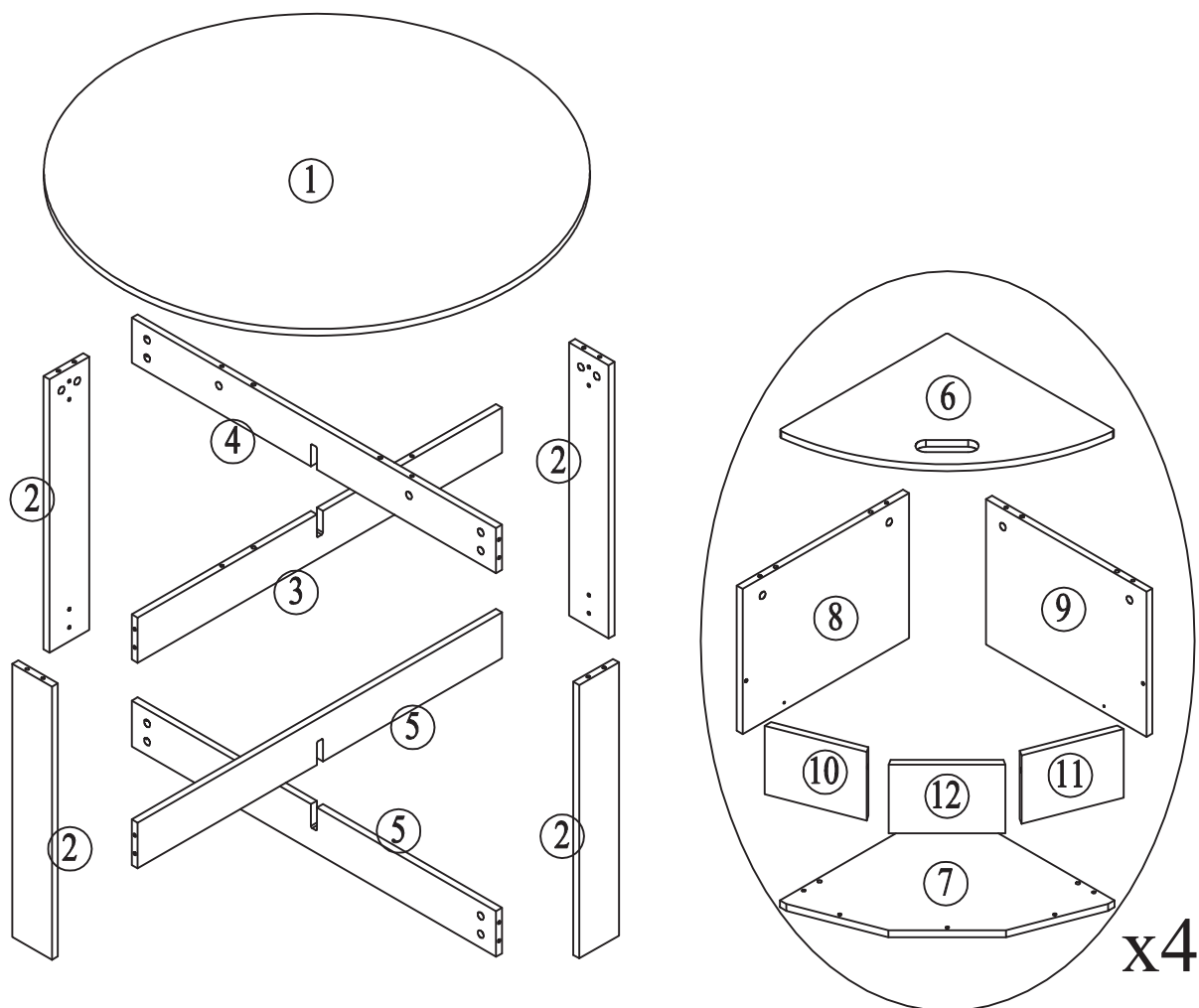

1

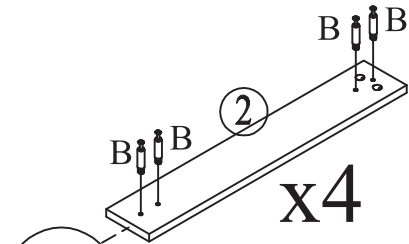
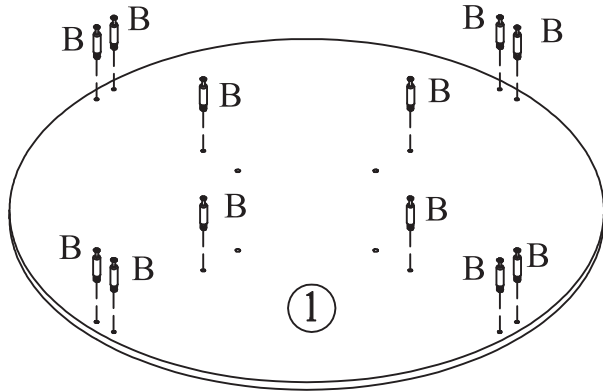

x4

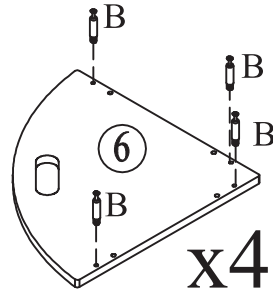

x4

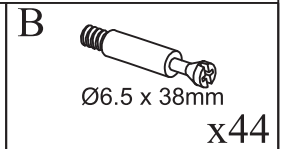
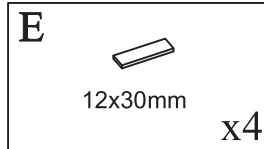
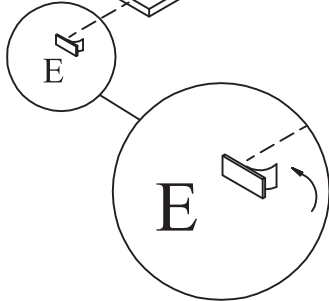
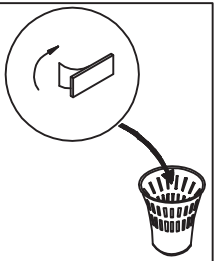
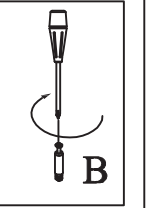
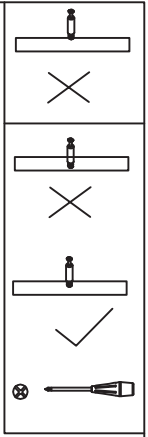

2

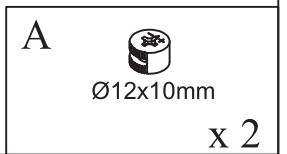
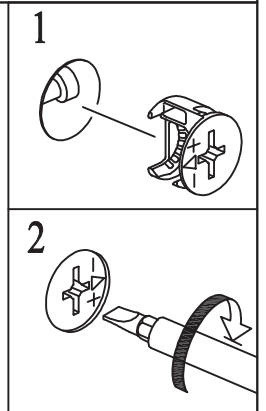
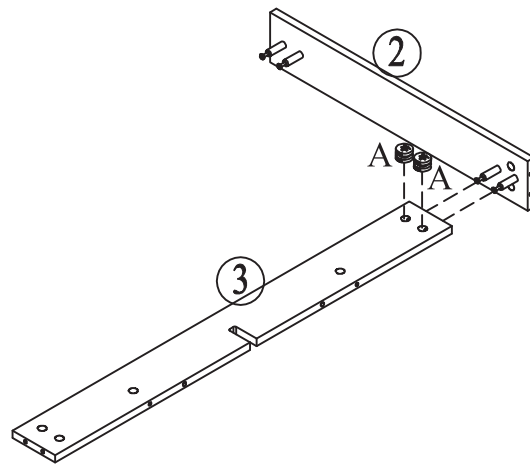

3

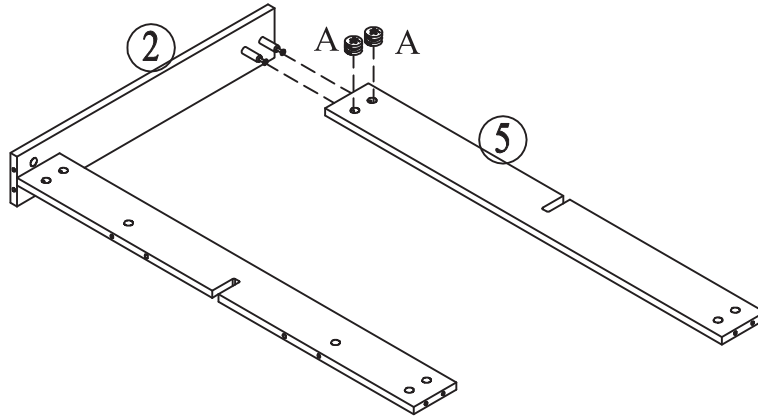

1

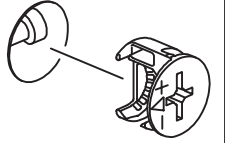

2

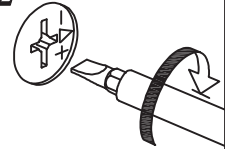

A

Ø12x10mm
x 2

4

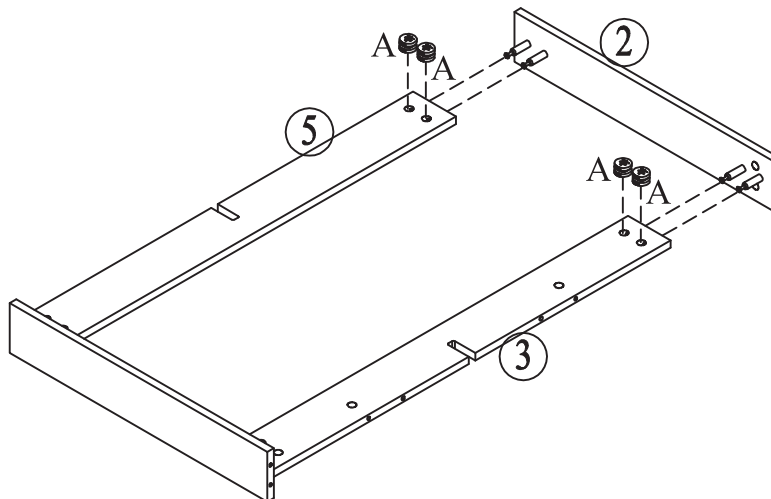

1

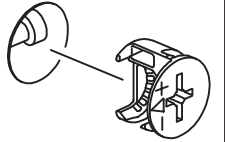

2

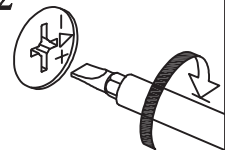

A

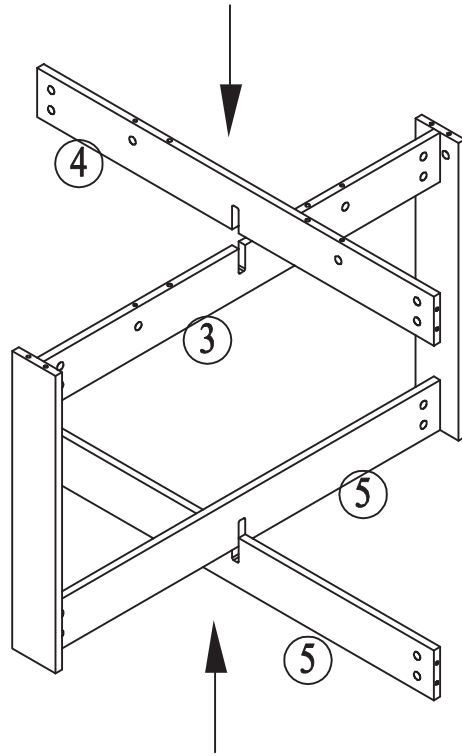

Ø12x10mm
x 4

5



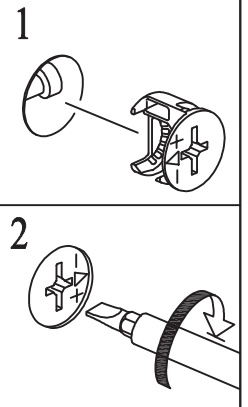
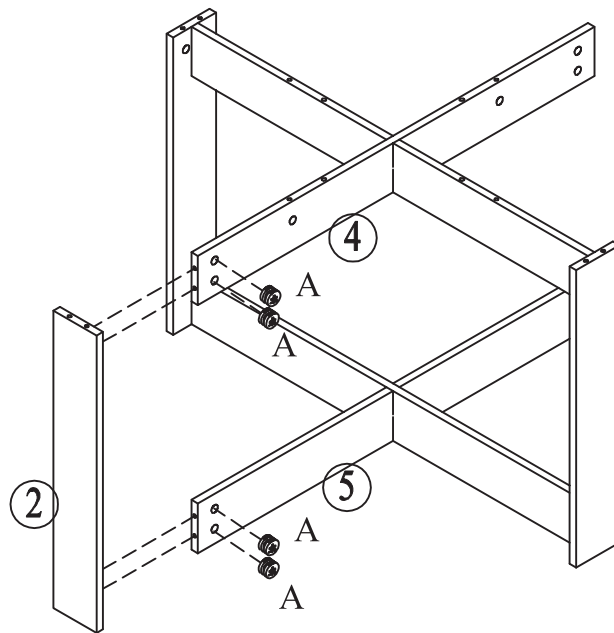

6

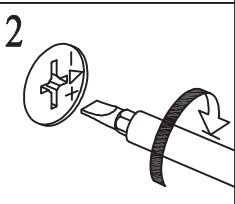
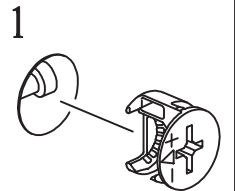
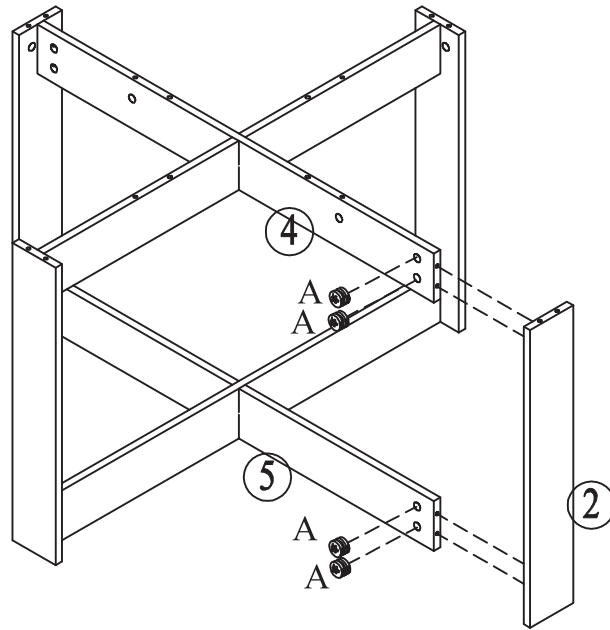

A 
Ø12x10mm
x 4

7



A

 Ø12x10mm
 x 4

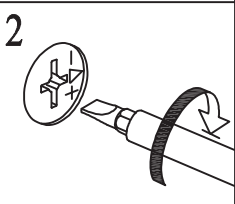
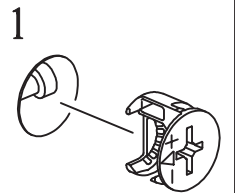
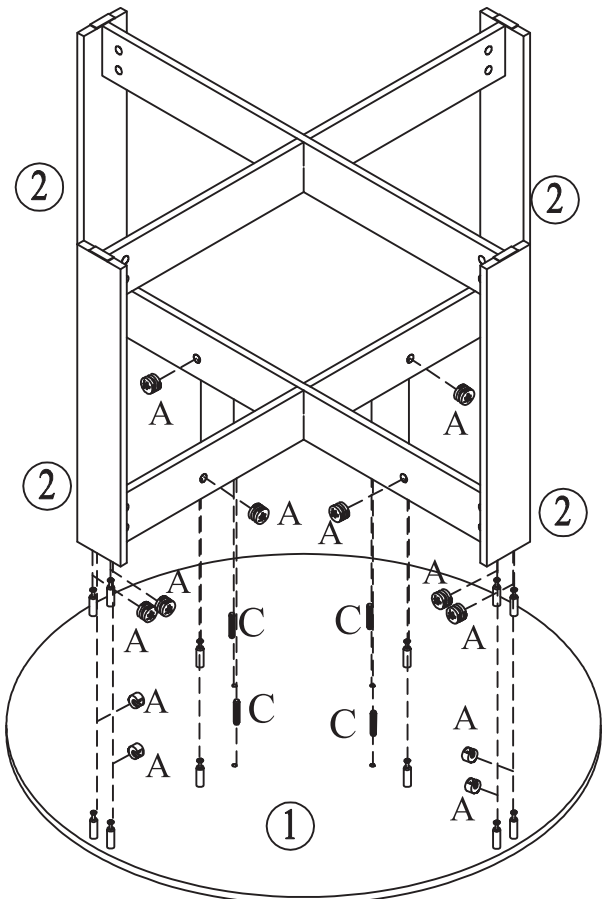
8



C

 Ø6 x 30mm
 x4

A

 Ø12x10mm
 x 12

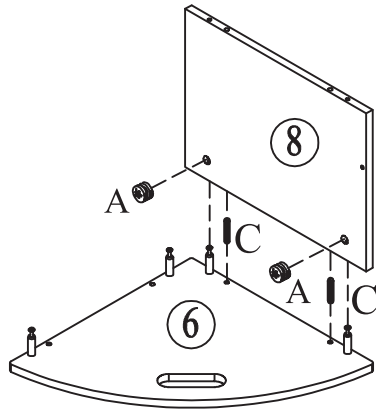
9

x4

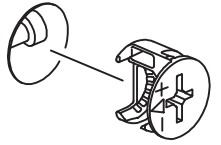

1



2

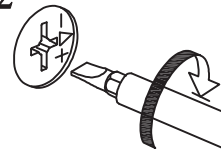

C



x 8

A



x 8

10

x4

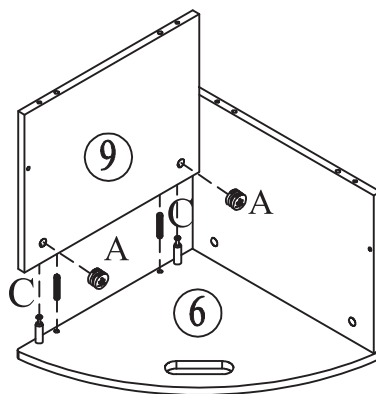

1

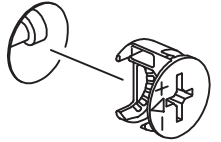

2

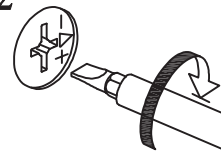

C



x 8

A





x 8

11

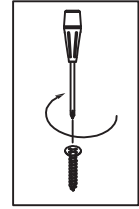
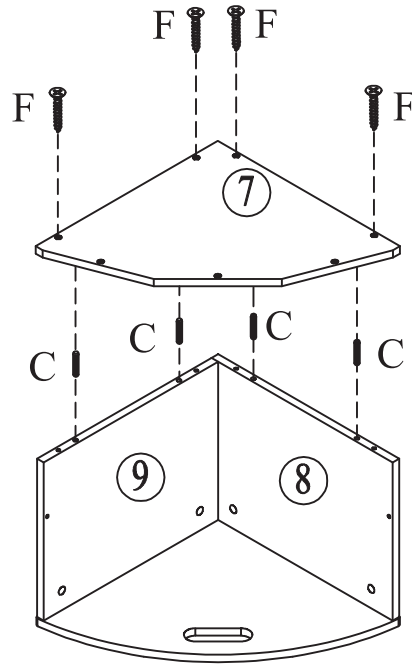
x4





C 
 Ø6 x 30mm x16

F 
 M4x30mm x16

12

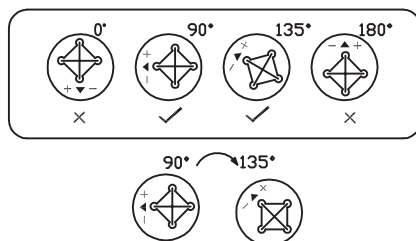
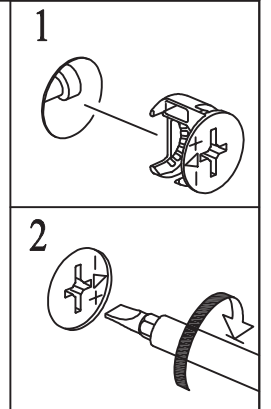
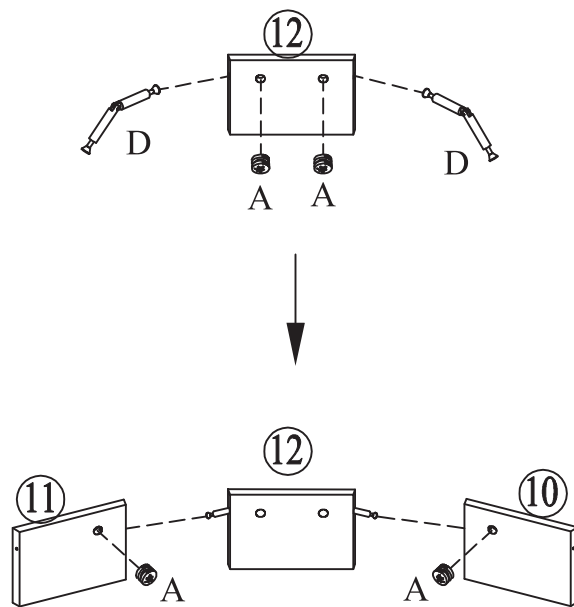
x4





A 
 Ø12x10mm x 16

D 
 x8

13

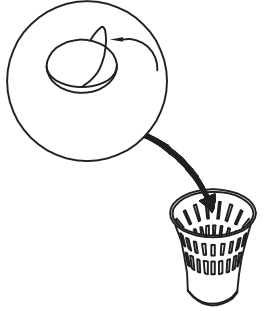
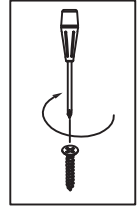
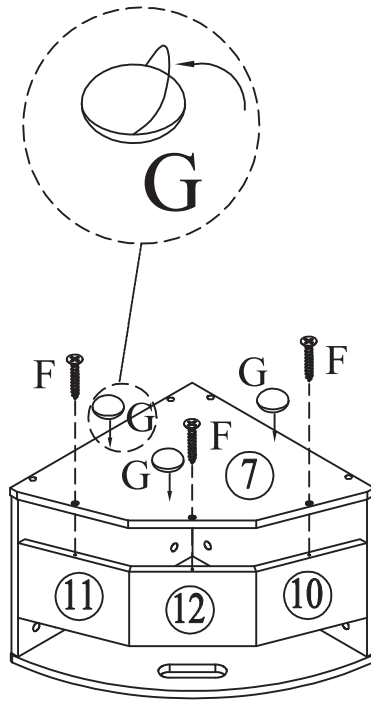
x4



| | |
|---|---|
| <p>G</p>  <p>Ø25mm</p> <p>x12</p> | <p>F</p>  <p>M4x30mm</p> <p>x12</p> |
|---|---|

14

x4

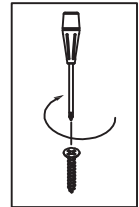
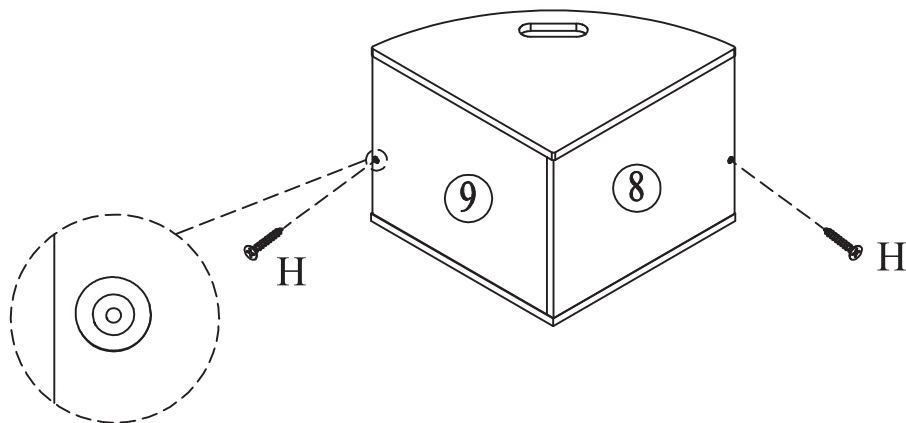

| |
|---|
| <p>H</p>  <p>M4x25mm</p> <p>x8</p> |
|---|

UK

If you have any questions, please contact our customer care center.

Our contact details are below:



0044-800-240-4004



enquiries@mhstar.co.uk

IMPORTER ADDRESS:

MH STAR UK LTD

Unit 27, Perivale Park,

Horsenden lane South

Perivale, UB6 7RH

MADE IN CHINA

ES

Si tiene alguna pregunta, comuníquese con nuestro Centro de Atención al Cliente.

Nuestros datos de contacto son los siguientes:



0034-931294512



atencioncliente@aosom.es

IMPORTADOR:

SPANISH AOSOM, S.L.

C/ ROC GROS, N° 15. 08550, ELS HOSTALETS DE

BALENYÀ, SPAIN.

B66295775

WWW.AOSOM.ES

ATENCIONCLIENTE@AOSOM.ES

TEL: 931294512

HECHO EN CHINA

FR

Si vous avez la moindre question, veuillez contacter notre centre d'assistance à la clientèle.

Nos coordonnées sont les suivantes:



0033-1-84166106



aosom@mhfrance.fr

Importé par:

MH France

2, rue Maurice Hartmann

92130 Issy-les-Moulineaux

France

Fabriqué en Chine

PT

Se tiver alguma dúvida, por favor contacte o nosso Centro de Atendimento ao Cliente.

Os nossos dados de contacto são os seguintes:



0034-931294512



info@aosom.pt.

IMPORTADOR:

SPANISH AOSOM, S.L

C.ROC GROS N.15, 08550. ELS HOSTALETS DE BALENYÀ

TEL: 931294512 (SEG-SEX DAS 7:30H ÀS 16:30H)

INFO@AOSOM.PT

WWW.AOSOM.PT

DE

Wenn Sie Fragen haben, wenden Sie sich bitte an unser Kundendienstzentrum.

Unsere Kontaktdaten stehen unten:



0049-0(40)-88307530



service@aosom.de

ADRESSE DES IMPORTEURE:

MH Handel GmbH

Wendenstraße 309

D-20537 Hamburg

Germany

IN CHINA HERGESTELLT

IT

In caso di dubbio, si prega di contattare il nostro centro assistenza clienti.

I nostri dettagli di contatto sono di seguito:



0039-0249471447



clienti@aosom.it

IMPORTATO DA:

AOSOM Italy srl

Centro Direzionale Milanofiori

Strada 1 Palazzo F1

20057 Assago (MI)

P.I.: 08567220960

FATTO IN CINA

