

AIYAPLAY

IN240300272V01_UK_DE_FR_IT_ES_PT

331-055V00

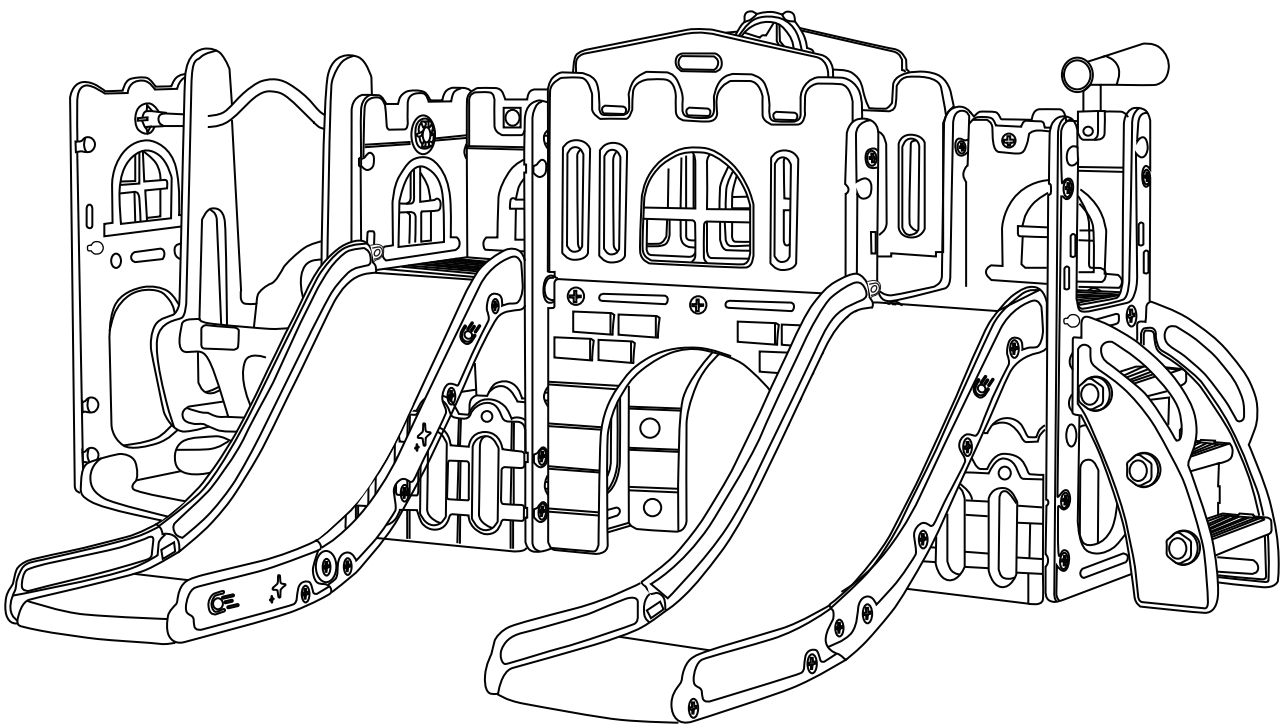

EN: **WARNING:** Suitable for children of 1+ years old; Max weight: 30 kg.
DE: **ACHTUNG:** Geeignet für Kinder im Alter von 1+ Jahren; Max. Gewicht: 30 kg.
FR: **ATTENTION:** Convient aux enfants de 1+ ans; Poids maximum : 30 kg.
IT: **AVVERTENZA:** Adatto a bambini di 1+ anni; Peso massimo: 30 kg.
ES: **ADVERTENCIA:** Adecuado para los niños de 1+ años; Peso máximo: 30 kg.
PT: **ADVERTÊNCIA:** Adequado para crianças de 1+ anos. Peso máximo: 30 kg.



EN_IMPORTANT, RETAIN FOR FUTURE REFERENCE: READ CAREFULLY.
DE_WICHTIG! SORFGFÄLTIG LESEN UND FÜR SPÄTERES NACHSCHLAGEN AUFBEWAHREN.
FR_IMPORTANT: A LIRE ATTENTIVEMENT ET A CONSERVER POUR VOUS Y REFRERER
ULTERIEUREMENT
IT_IMPORTANTE, LEGGERE E CONSERVARE QUESTO MANUALE D'ISTRUZIONE PER UN USO
FUTURO.
ES_IMPORTANTE, LEA DETENIDAMENTE Y GUARDE PARA FUTURAS REFERENCIAS.
PT_IMPORTANTE, GUARDE PARA FUTURA REFERÊNCIA, LEIA ATENTAMENTE.

WARNING

- Only allowed for adults to install, keep children away.
- To be used under the direct supervision of an adult.
- Keep away from fire! Keep away from water!
- This product contains small parts and a packaging bag inside. Keep away from small children when unassembled.
- Once installed, adult supervision is required when in use.
- This product is for domestic household use. Place safety mats around the equipment when using it. Children must be under adult supervision to ensure safety.
- Maximum load: 30kg.
- Place this equipment on a level surface, at least 2m from walls, fences, electrical wires and other obstructions.
- Ensure there is at least 200mm of space between the swing and floor.
- Do not install this equipment on concrete, asphalt or other hard surfaces.
- Keep away from direct sunlight.
- Keep this manual safe for future reference.
- Do not modify (e.g., adding accessories) this equipment, unless recommended by the manufacturer.

Maintenance

Periodically check the main parts (cross beams, suspensions, anchors, etc) to ensure they are tight and are in good working condition. Follow these steps when checking this equipment:

- a) Ensure all nuts and bolts are tight.
- b) Oil all metallic moving parts to prevent rust.
- c) Check coverings for bolts and sharp edges - replace when needed.
- d) Check swing seats, chains, ropes and other attachments for any damages or deterioration.
- e) Replace defective parts by following the manufacturer's instructions.
- f) Keep all instructions and parts relating to this product for future reference.
- g) If any problem occurred, please sent it to qualified maintainer.
- h) Clean your toy with a clean damp cloth.

ACHTUNG

- Die Montage darf nur von Erwachsenen vorgenommen werden, halten Sie Kinder fern.
- Es ist unter der direkten Aufsicht eines Erwachsenen zu verwenden.
- Halten Sie es von Feuer fern! Halten Sie es von Wasser fern!
- Dieses Produkt enthält Kleinteile und einen Verpackungsbeutel im Inneren. Halten Sie es fern von kleinen Kindern, wenn es nicht zusammengebaut ist.
- Nach der Installation ist bei der Verwendung die Aufsicht eines Erwachsenen erforderlich.
- Die Verwendung dieses Produkts ist für den Hausgebrauch bestimmt. Legen Sie bei der Verwendung Sicherheitsmatten um das Gerät. Kinder müssen unter Aufsicht von Erwachsenen stehen, um die Sicherheit zu gewährleisten.
- Maximale Belastung: 30 kg.
- Stellen Sie das Gerät auf einer ebenen Fläche auf, mindestens 2 m von Wänden, Zäunen, elektrischen Leitungen und anderen Hindernissen entfernt.
- Stellen Sie sicher, dass zwischen der Schaukel und dem Boden ein Abstand von mindestens 200 mm besteht.
- Installieren Sie dieses Gerät nicht auf Beton, Asphalt oder anderen harten Oberflächen.
- Halten Sie es von direkter Sonneneinstrahlung fern.
- Bewahren Sie diese Bedienungsanleitung sicher zum späteren Nachschlagen auf.
- Nehmen Sie keine Änderungen (z. B. Hinzufügen von Zubehör) an diesem Gerät vor, es sei denn, dies wird vom Hersteller empfohlen.

Wartung

Prüfen Sie regelmäßig die wichtigsten Teile (Traversen, Aufhängungen, Verankerungen usw.), um sicherzustellen, dass sie festsitzen und in gutem Zustand sind. Befolgen Sie die folgenden Schritte, wenn Sie diese Ausrüstung prüfen:

- a) Stellen Sie sicher, dass alle Muttern und Bolzen fest angezogen sind.
- b) Ölen Sie alle beweglichen Metallteile, um Rost zu vermeiden.
- c) Prüfen Sie die Abdeckungen auf Bolzen und scharfe Kanten - ersetzen Sie sie, wenn nötig.
- d) Prüfen Sie Schaukelsitze, Ketten, Seile und sonstiges Zubehör auf Beschädigungen und Abnutzung.
- e) Ersetzen Sie defekte Teile gemäß den Anweisungen des Herstellers.
- f) Bewahren Sie alle Anweisungen und Teile, die sich auf dieses Produkt beziehen, zur späteren Verwendung auf.
- g) Bei Auftreten eines Problems, suchen Sie bitte eine qualifizierten Werkstatt auf.
- h) Reinigen Sie das Spielzeug mit einem sauberen, feuchten Tuch.

ATTENTION

- Installation par des adultes uniquement, tenir les enfants à l'écart.
- À utiliser sous la surveillance directe d'un adulte.
- Loin du feu ! Loin de l'eau !
- Ce produit présente de petites pièces et un sac d'emballage en son sein. Garder hors de portée des jeunes enfants lorsqu'il n'est pas assemblé.
- Une fois installé, la surveillance d'un adulte est requise lors de l'utilisation.
- Ce produit est destiné à un usage domestique. Posez des tapis de sécurité autour de l'équipement lorsque vous l'utilisez. Les enfants doivent être sous la surveillance d'un adulte pour en assurer la sécurité.
- Charge maximale : 30kg.
- Installez cet équipement sur une surface plane, à au moins 2m des murs, clôtures, fils électriques et autres obstructions.
- Prévoyez un espace d'au moins 200 mm entre la balançoire et le sol.
- N'installez pas cet équipement sur du béton, de l'asphalte ou d'autres surfaces dures.
- Tenir à l'écart de la lumière directe du soleil.
- Conservez ce manuel en lieu sûr pour vous y référer ultérieurement.
- Ne modifiez pas (par exemple, en ajoutant des accessoires) cet équipement, sauf si cela est recommandé par le fabricant.

Entretien

Inspectez périodiquement les pièces principales (traverses, suspensions, ancrages, etc.) afin de vous assurer qu'elles sont bien serrées et qu'elles sont en bon état de fonctionnement. Procédez comme suit lorsque vous vérifiez cet équipement :

- a) Assurez-vous que tous les écrous et les boulons sont bien serrés.
- b) Huiler toutes les pièces métalliques mobiles pour éviter la rouille.
- c) Vérifiez l'absence de boulons et d'arêtes vives sur les revêtements - remplacez-les si nécessaire.
- d) Vérifiez que les sièges de balançoire, les chaînes, les cordes et les autres accessoires ne sont pas endommagés ou détériorés.
- e) Remplacer les pièces défectueuses en suivant les instructions du fabricant.
- f) Conservez toutes les instructions et les pièces relatives à ce produit pour pouvoir vous y référer ultérieurement.
- g) Si un problème survient, veuillez l'envoyer à un technicien qualifié.
- h) Nettoyez votre jouet avec un chiffon propre et humide.

AVVERTENZE

- L'installazione deve essere fatta da adulti, tenere lontani i bambini.
- Da utilizzare sotto la diretta supervisione di un adulto.
- Tenere lontano dal fuoco! Tenere lontano dall'acqua!
- Questo prodotto contiene piccole parti e un sacchetto di imballaggio al suo interno. Tenere lontano dai bambini piccoli quando viene smontato.
- Una volta installato il prodotto, è necessaria la supervisione di un adulto durante l'uso.
- Questo prodotto è destinato solo all'uso domestico. Posizionare tappetini di sicurezza attorno alla struttura durante l'utilizzo. I bambini devono essere supervisionati da un adulto per garantire la loro sicurezza.
- Carico massimo: 30 kg.
- Posizionare la struttura su una superficie piana, ad almeno 2 metri da muri, recinzioni, cavi elettrici e altri ostacoli.
- Assicurarsi di lasciare almeno 200 mm di spazio tra l'altalena e il pavimento.
- Non installare questa struttura su cemento, asfalto o altre superfici dure.
- Tenere lontano dalla luce solare diretta.
- Conservare questo manuale al sicuro per riferimenti futuri.
- Non modificare (ad esempio aggiungendo accessori) questa struttura, a meno che non sia consigliato dal produttore.

Manutenzione

Controllare periodicamente le parti principali (supporti, sospensioni, ancoraggi, etc.) per assicurarsi che siano ben strette e in buone condizioni. Seguire questi passaggi quando si controlla la struttura:

- a) Assicurarsi che tutti i dadi e i bulloni siano stretti.
- b) Oliare tutte le parti mobili metalliche per prevenire la formazione di ruggine.
- c) Controllare i rivestimenti per bulloni e verificare la presenza di spigoli vivi - sostituirli quando necessario.
- d) Controllare i sedili dell'altalena, le catene, le corde e gli altri accessori per rilevare eventuali danni o segni di deterioramento.
- e) Sostituire le parti difettose seguendo le istruzioni del produttore.
- f) Conservare tutte le istruzioni e le parti relative a questo prodotto per riferimenti futuri.
- g) Se si verifica un problema, chiedere assistenza a un manutentore qualificato.
- h) Pulire il gioco con un panno umido pulito.

ADVERTENCIA

- La instalación sólo se puede realizar por los adultos, mantenga a los niños alejados al instalar el producto.
- El producto debe ser utilizado bajo la supervisión directa de un adulto.
- ¡Mantenga el producto alejado del fuego y del agua!
- Este producto contiene piezas pequeñas y una bolsa de embalaje en su interior. Manténgalo alejado de los niños pequeños cuando esté desmontado.
- Una vez instalado, se requiere la supervisión de un adulto cuando esté en uso.
- Este producto es para uso doméstico. Coloque alfombrillas de seguridad alrededor del equipo cuando lo utilice. Los niños deben estar bajo la supervisión de un adulto para garantizar la seguridad.
- Carga máxima: 30kg.
- Coloque este equipo sobre una superficie nivelada, a una distancia mínima de 2 m de paredes, vallas, cables eléctricos y otros obstáculos.
- Asegúrese de que haya al menos 200 mm de espacio entre el columpio y el suelo.
- No instale este equipo sobre hormigón, asfalto u otras superficies duras.
- Manténgalo alejado de la luz solar directa.
- Guarde este manual para futuras consultas.
- No modifique (por ejemplo, añadiendo accesorios) este equipo, a menos que lo recomiende el fabricante.

Mantenimiento

Compruebe periódicamente las piezas principales (vigas transversales, suspensiones, anclajes, etc.) para asegurarse de que están apretadas y se encuentran en buenas condiciones de funcionamiento. Siga estos pasos cuando revise este equipo:

- a) Asegúrese de que todos los tornillos y tuercas están apretados.
- b) Lubrique todas las piezas metálicas móviles para evitar la oxidación.
- c) Compruebe si hay tornillos o bordes afilados en los revestimientos; sustitúyalos cuando sea necesario.
- d) Compruebe que los asientos de los columpios, las cadenas, las cuerdas y otros accesorios no estén dañados o deteriorados.
- e) Sustituya las piezas defectuosas siguiendo las instrucciones del fabricante.
- f) Guarde todas las instrucciones y piezas relativas juntas con este producto para las referencias futuras.
- g) Si tiene algún problema, envíe el producto a un profesional de mantenimiento cualificado.
- h) Limpie el juguete con un paño húmedo y limpio.

ADVERTÊNCIA

- Permitido apenas para adultos instalarem, manter crianças afastadas.
- Para ser utilizado sob a supervisão direta de um adulto.
- Manter longe do fogo! Manter longe da água!
- Este produto contém peças pequenas e uma bolsa de embalagem no seu interior. Manter afastado de crianças pequenas quando não estiver montado.
- Uma vez instalado, é necessária a supervisão de um adulto quando estiver a ser utilizado.
- Este produto destina-se a utilização doméstica. Coloque tapetes de segurança em torno do equipamento quando for utilizá-lo. As crianças devem estar sob a supervisão de um adulto para garantir a segurança.
- Capacidade de carga máxima: 30kg.
- Coloque este equipamento numa superfície plana, a pelo menos 2 m de paredes, vedações, fios eléctricos e outras obstruções.
- Assegure-se de que existe um espaço mínimo de 200 mm entre o baloiço e o chão.
- Não instale este equipamento em betão, asfalto ou outras superfícies duras.
- Manter afastado da luz solar direta.
- Guarde este manual num local seguro para referência futura.
- Não modifique (por ex., adicionando acessórios) este equipamento, exceto se houver recomendação do fabricante.

Manutenção

Verificar periodicamente as partes principais (vigas transversais, suspensões, âncoras, etc.) para garantir que estão apertadas e em boas condições de funcionamento. Siga os passos seguintes para verificar este equipamento:

- a) Certifique-se de que todas as porcas e parafusos estão apertados.
- b) Lubrificar todas as partes metálicas móveis para evitar a ferrugem.
- c) Verificar se os revestimentos têm parafusos e arestas vivas - substituir quando for necessário.
- d) Verificar se os assentos dos baloiços, as correntes, as cordas e outros acessórios apresentam danos ou deterioração.
- e) Substituir as peças defeituosas seguindo as instruções do fabricante.
- f) Guarde todas as instruções e peças relacionadas a este produto para referência futura.
- g) Em caso de algum problema, por favor, envie-o para um mantenedor qualificado.
- h) Limpe o seu brinquedo com um pano úmido e limpo.

A

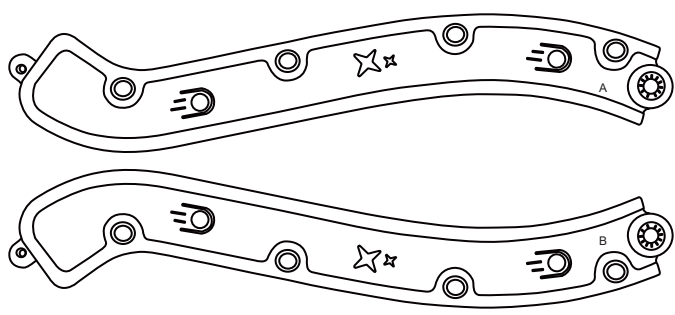

ABx2

B

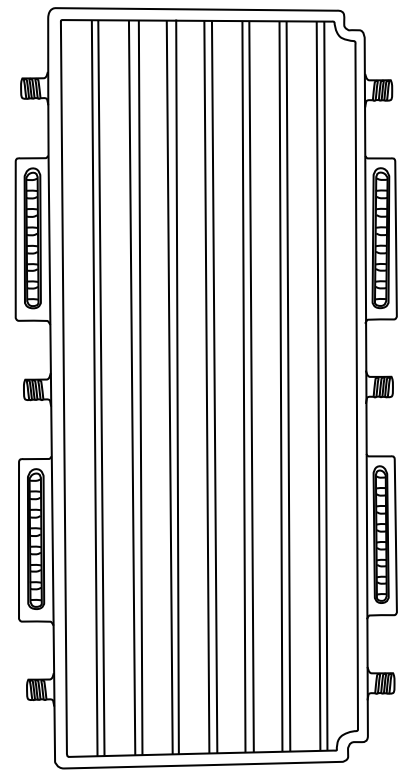

x1

C

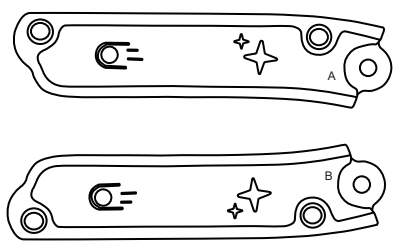

ABx2

D

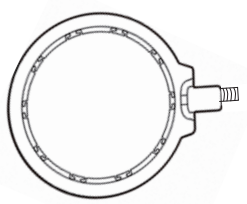

x1

E

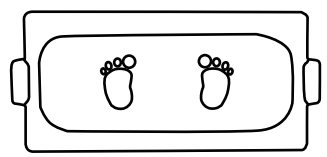

x2

F

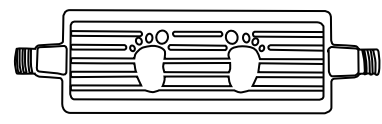

x3

G

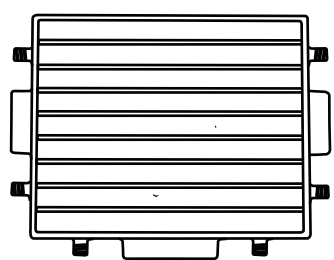

x2

H

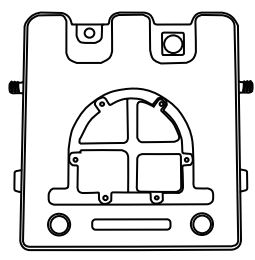

x2

I

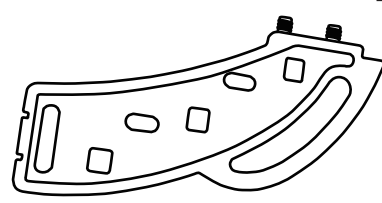

x2

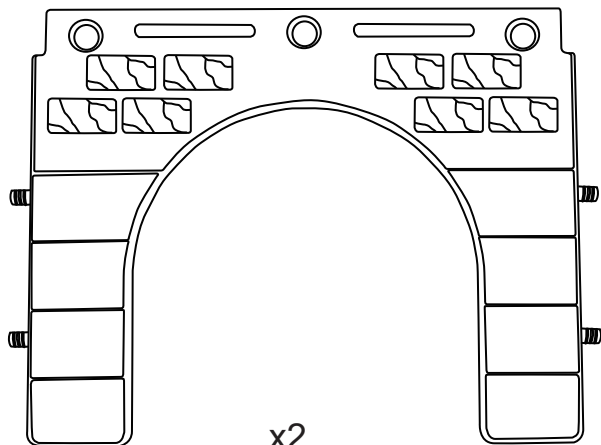

J

x2

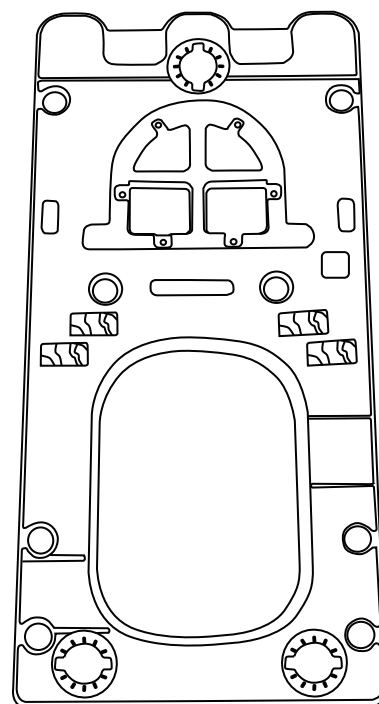

K

x2

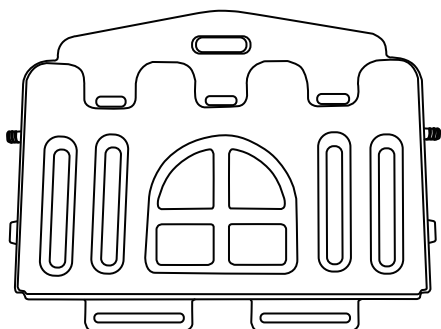

L

x2

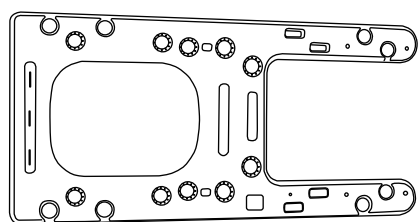

M

x3

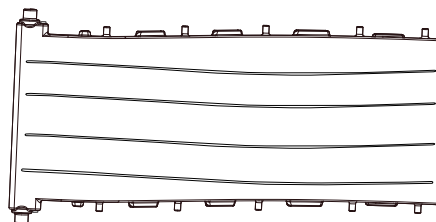

N

x2

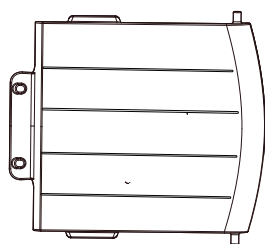

O

x2

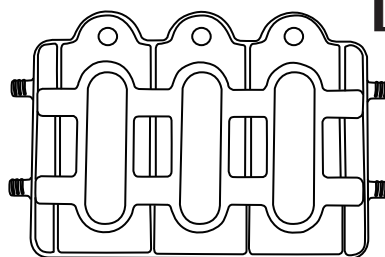

P

x4

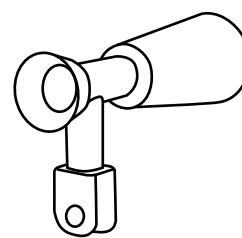

Q

x1

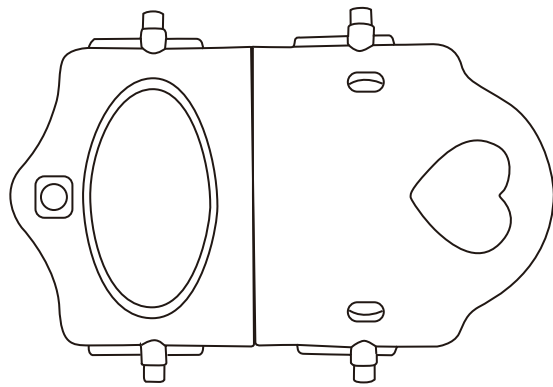

x1

R

S

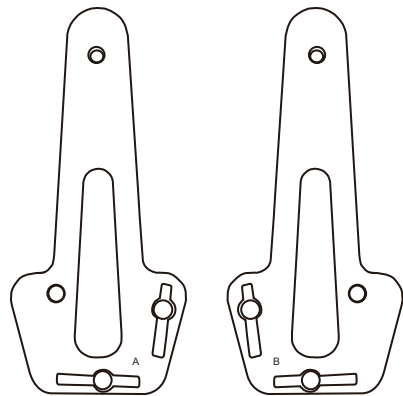

ABx1

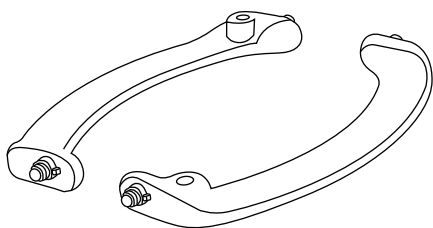

x1

T

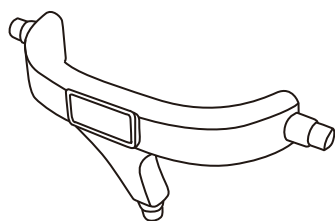

x1

U



x1

V

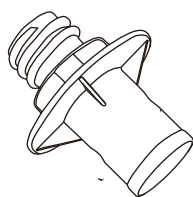

x1

W

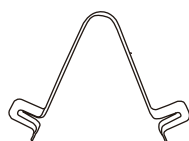

x1+1(spare)

X

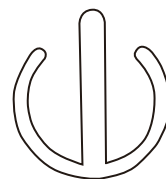

x4+1(spare)

Y

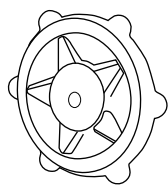

x1

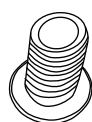
z

10*20mm

x1

a

x13+1(spare)

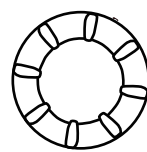
b

x10+1(spare)

c

x55+2(spare)

d

x28+2(spare)

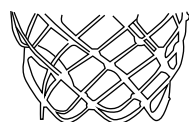
e

x1

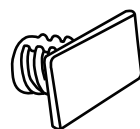
f

x4+1(spare)

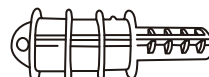
g

x1

h

x2+1(spare)

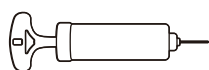
j

x1

k

x1

i

8*35mm

x1

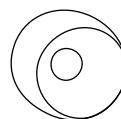
m

x1

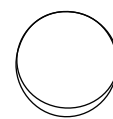
n

x1

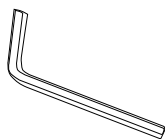
p

x2

q

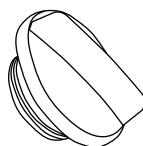

M10

x1

r

x2

s

e X2	g X2
	

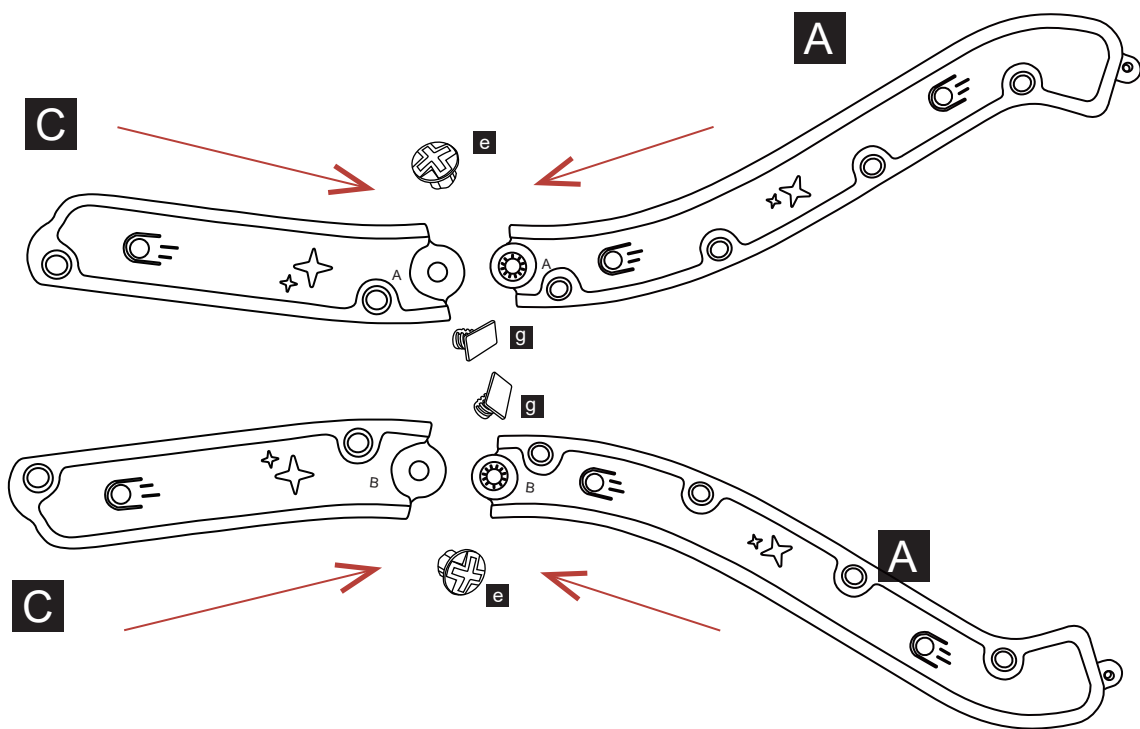

x2

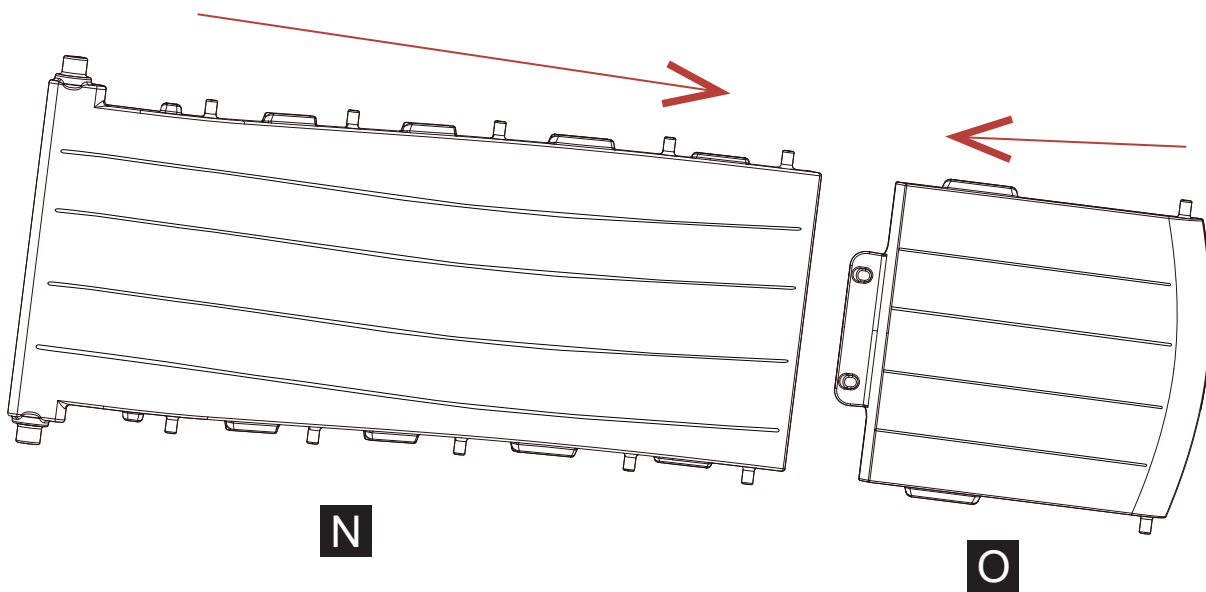

x2

e X12

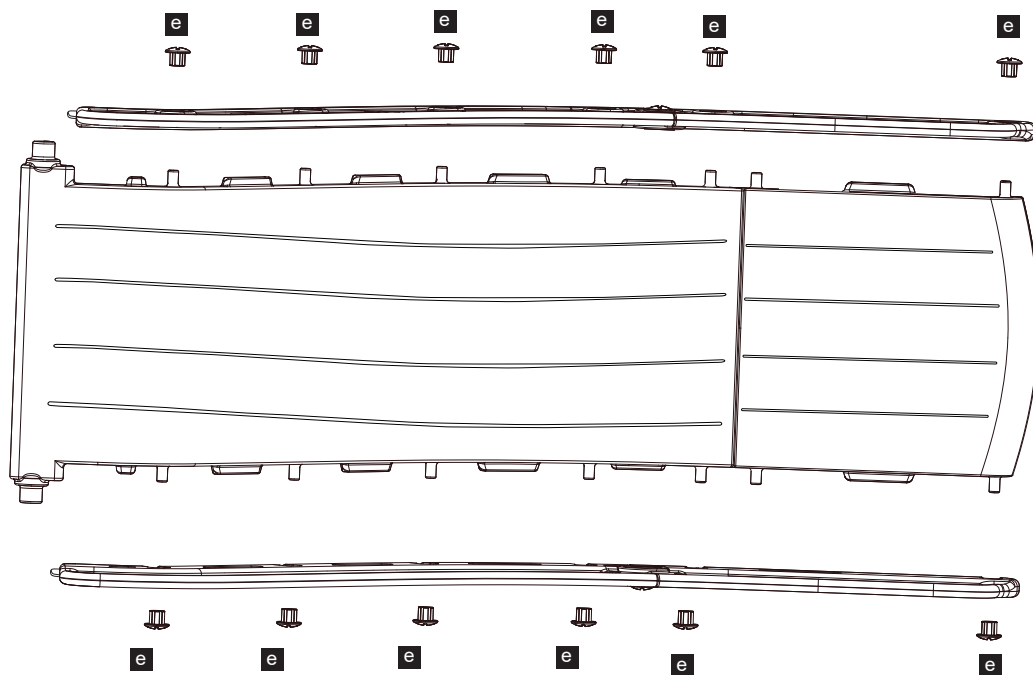

x2

d X4

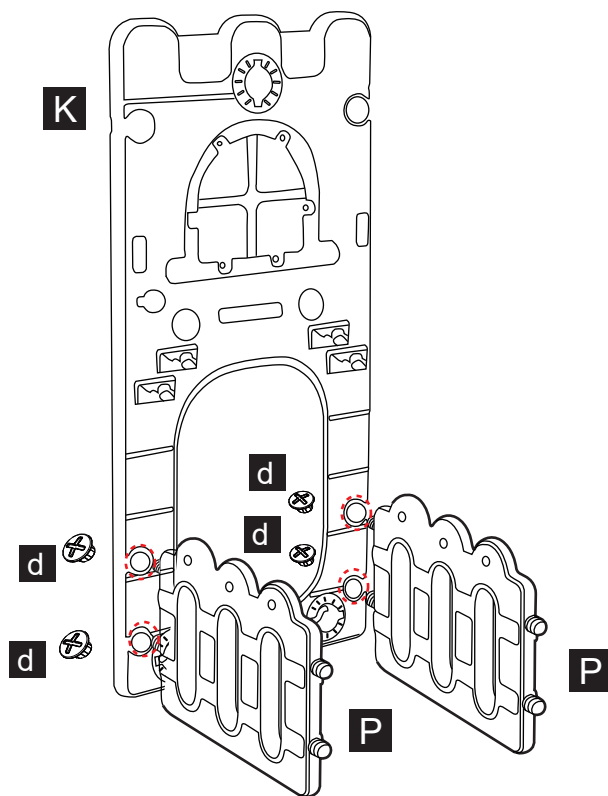

d X 5

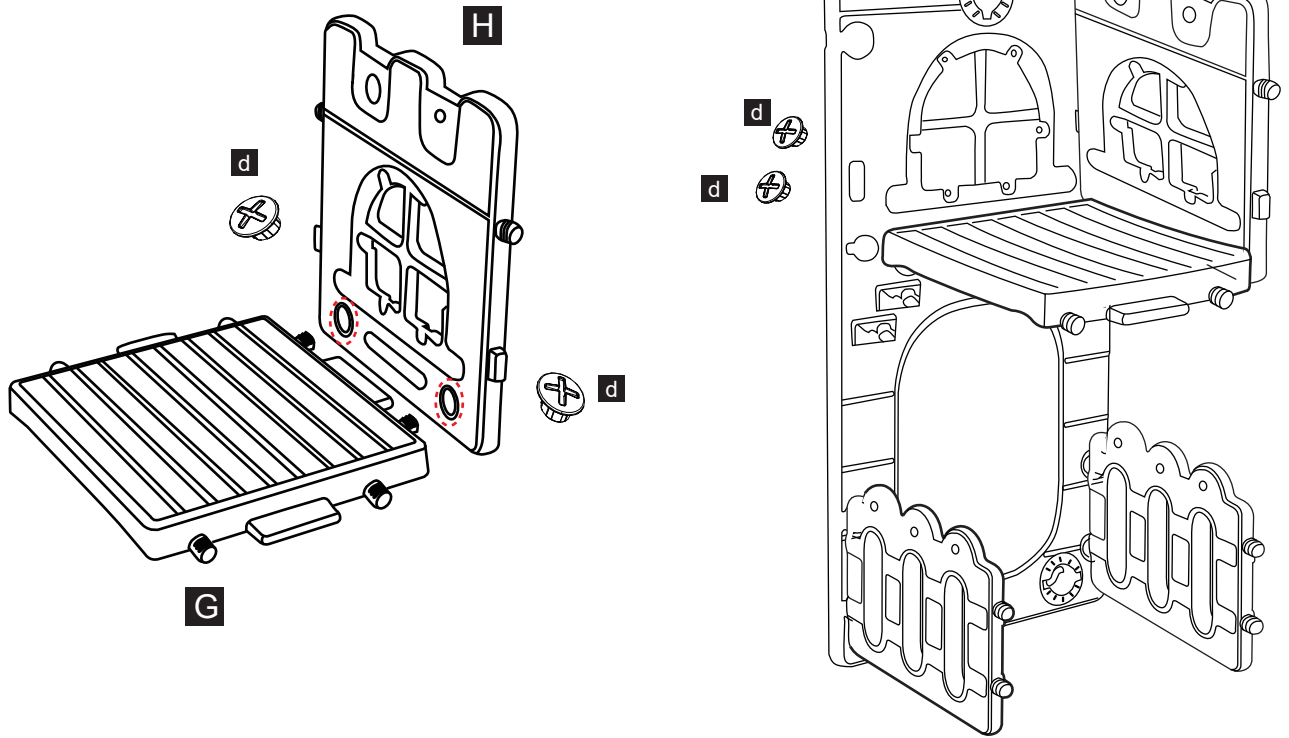

c X 2



d X 8

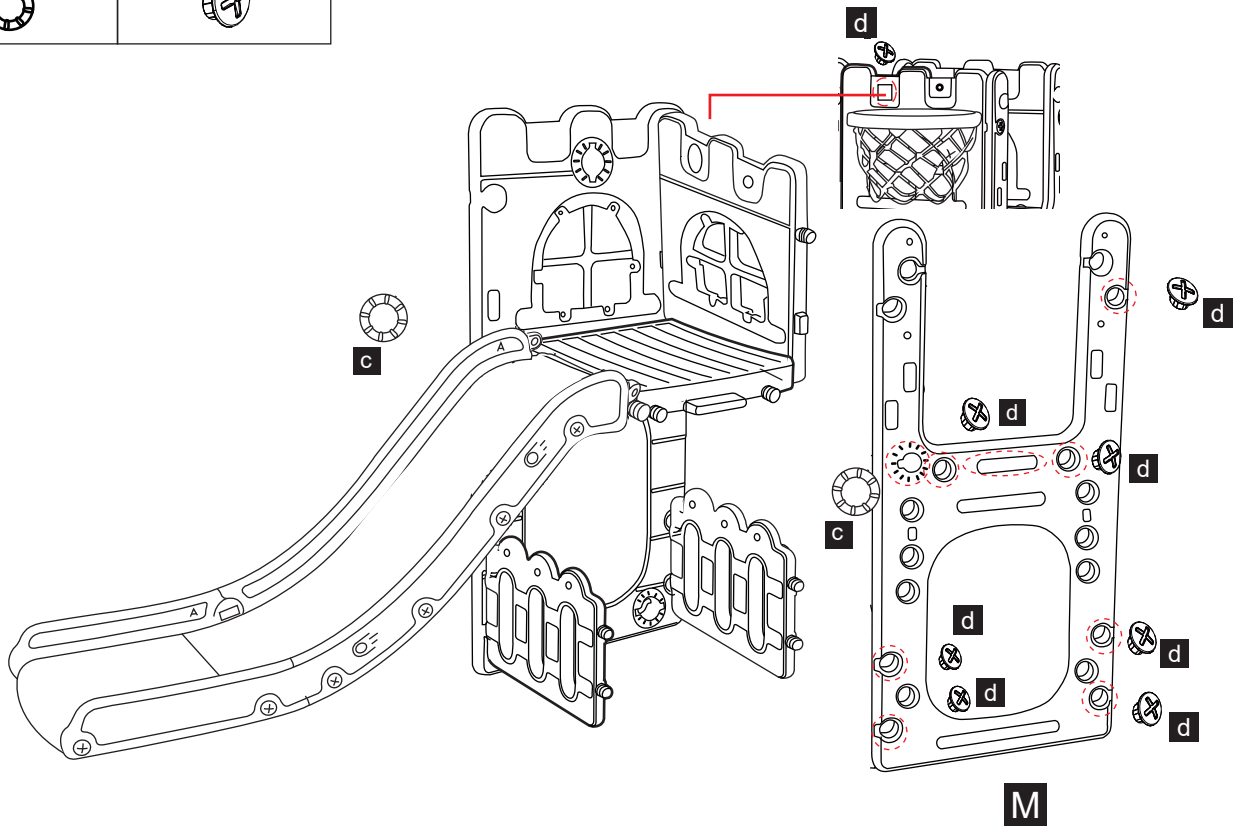

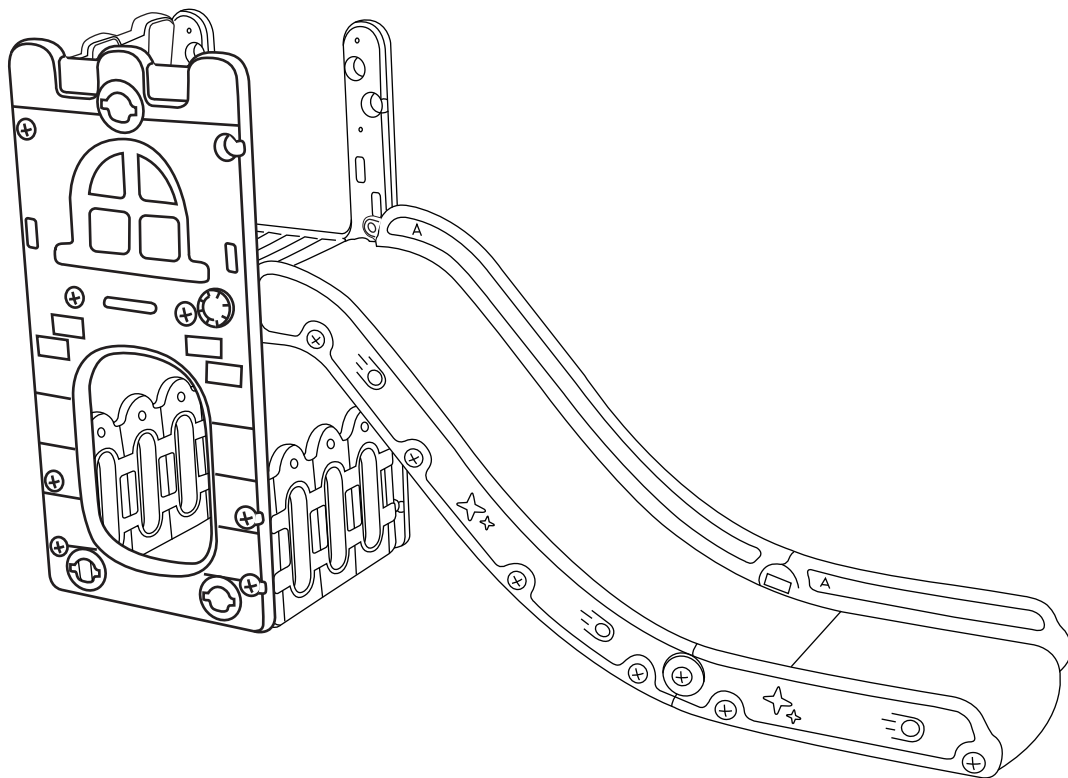

c X2

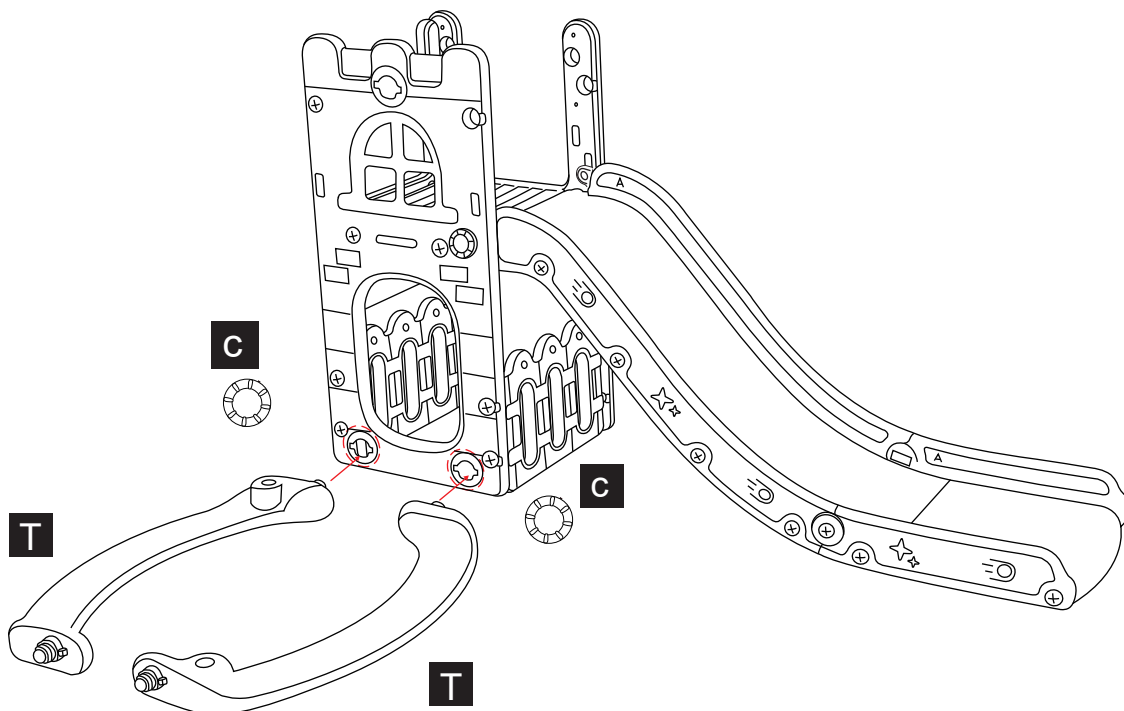

b X 4

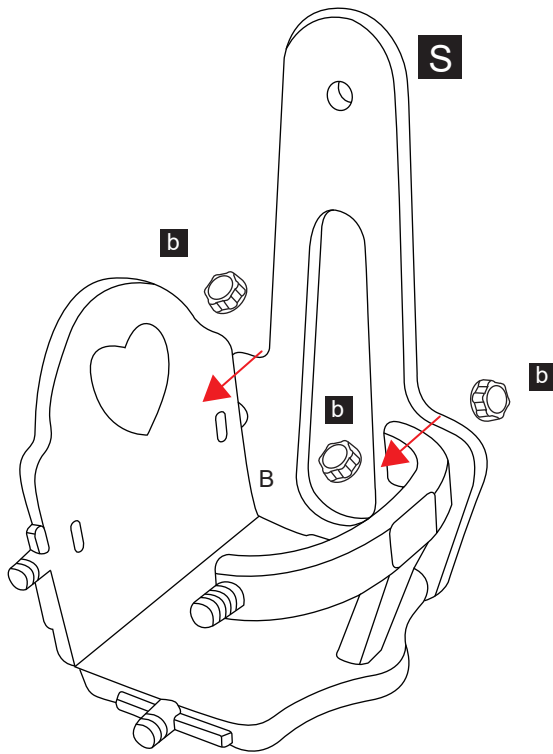
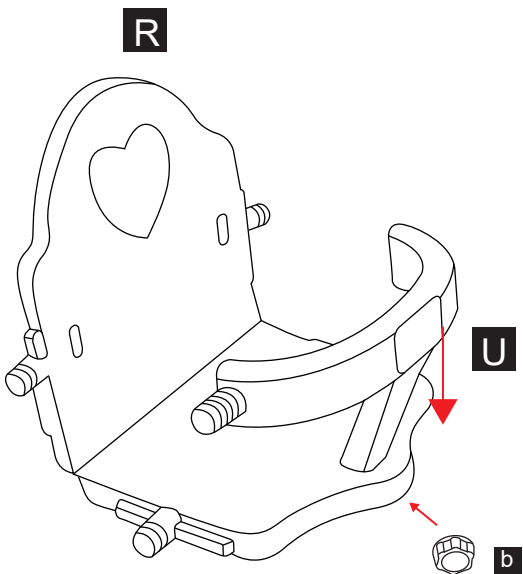

b X 3



Y X 4



W X 1



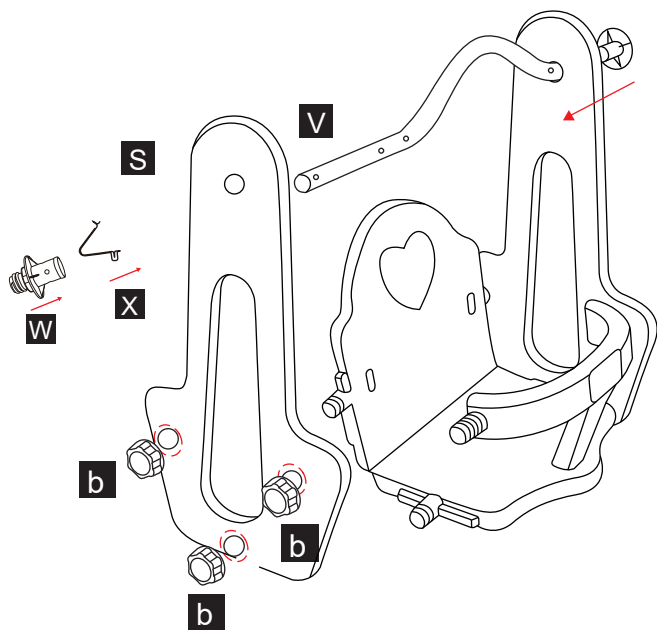

X X 1

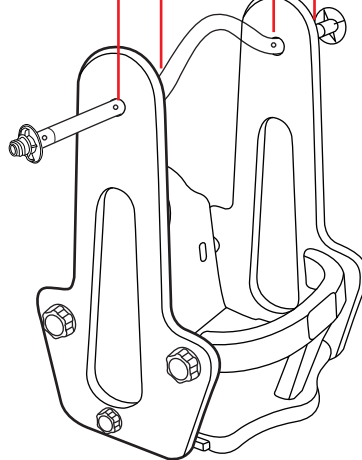

Y





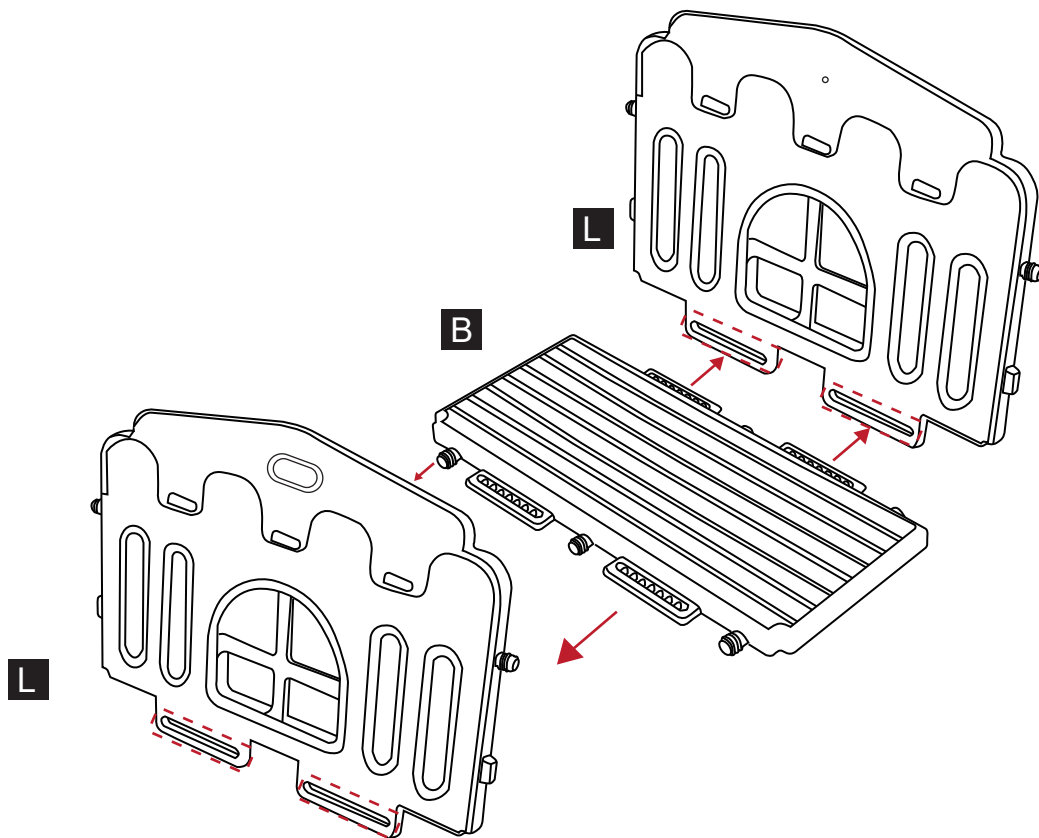
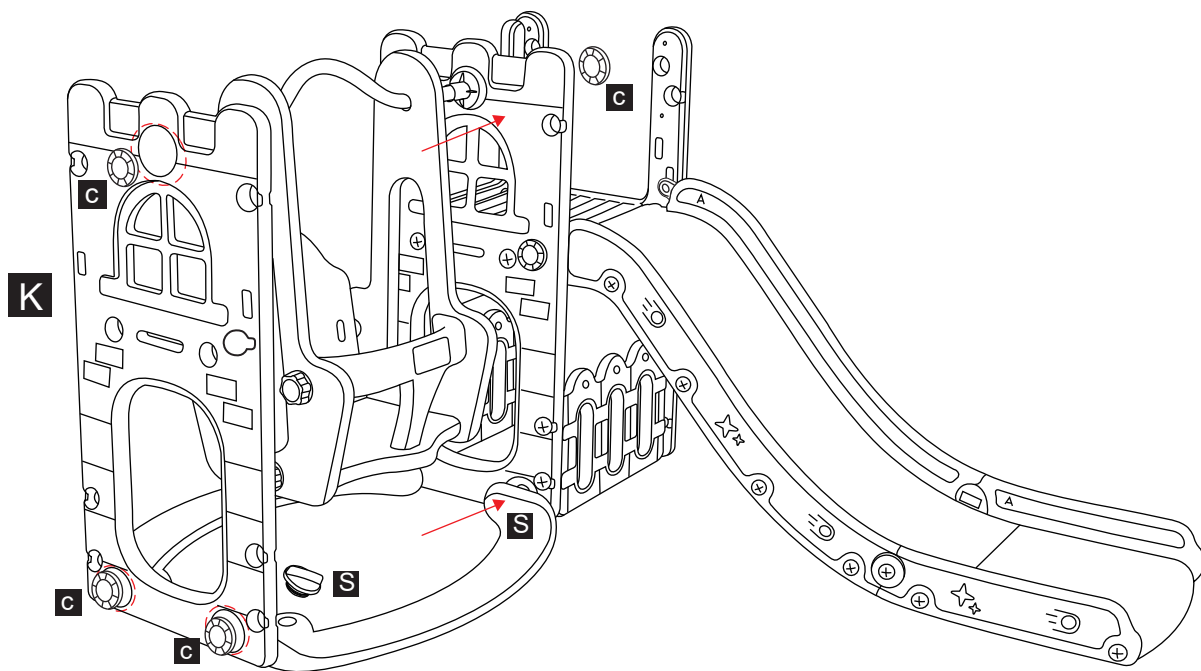

c X4	s X2
	

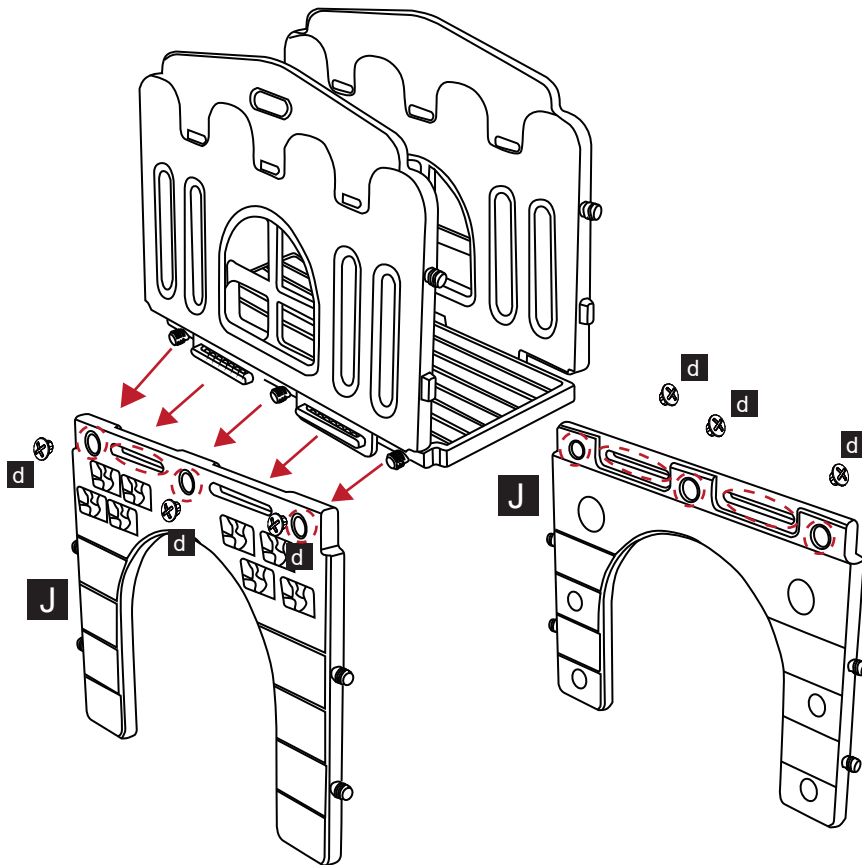

d X 6



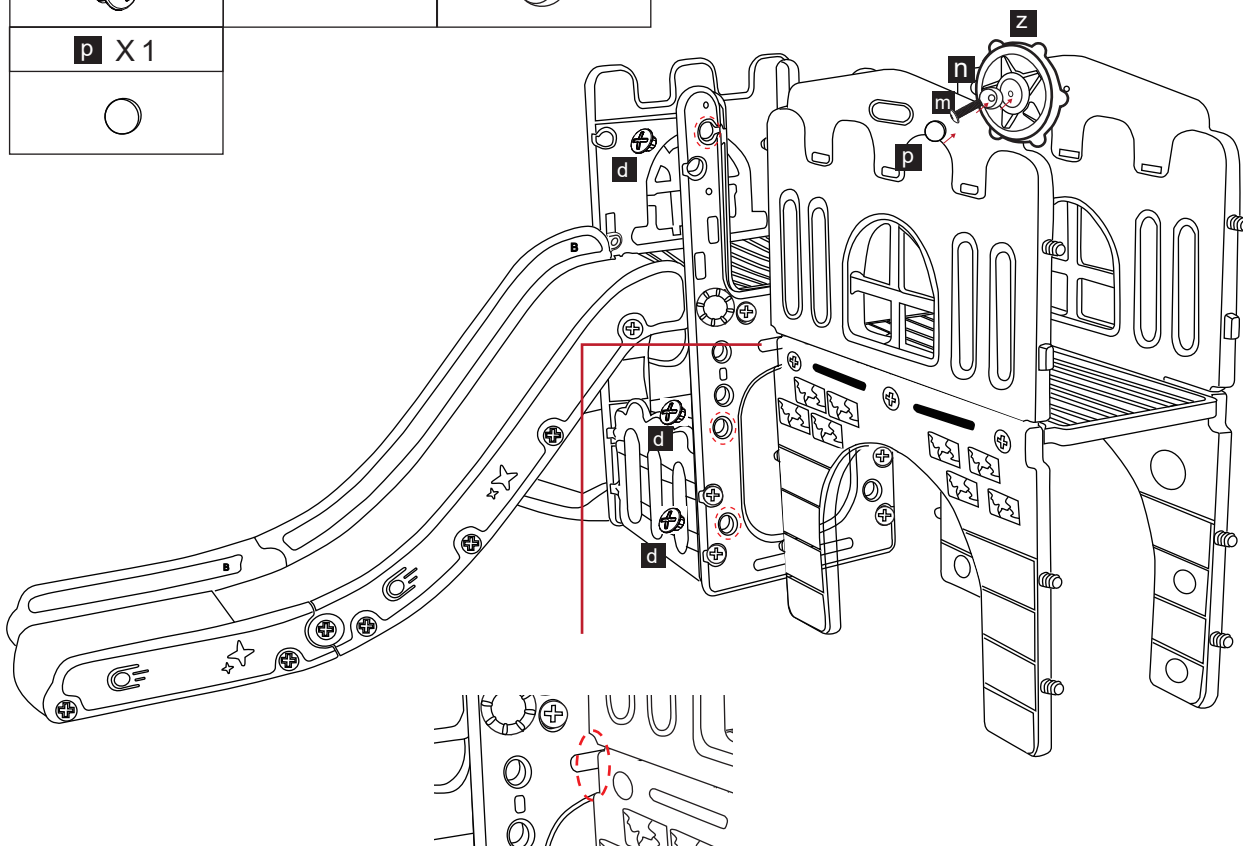

d X 6	m X 1	n X 1
		
p X 1		
		



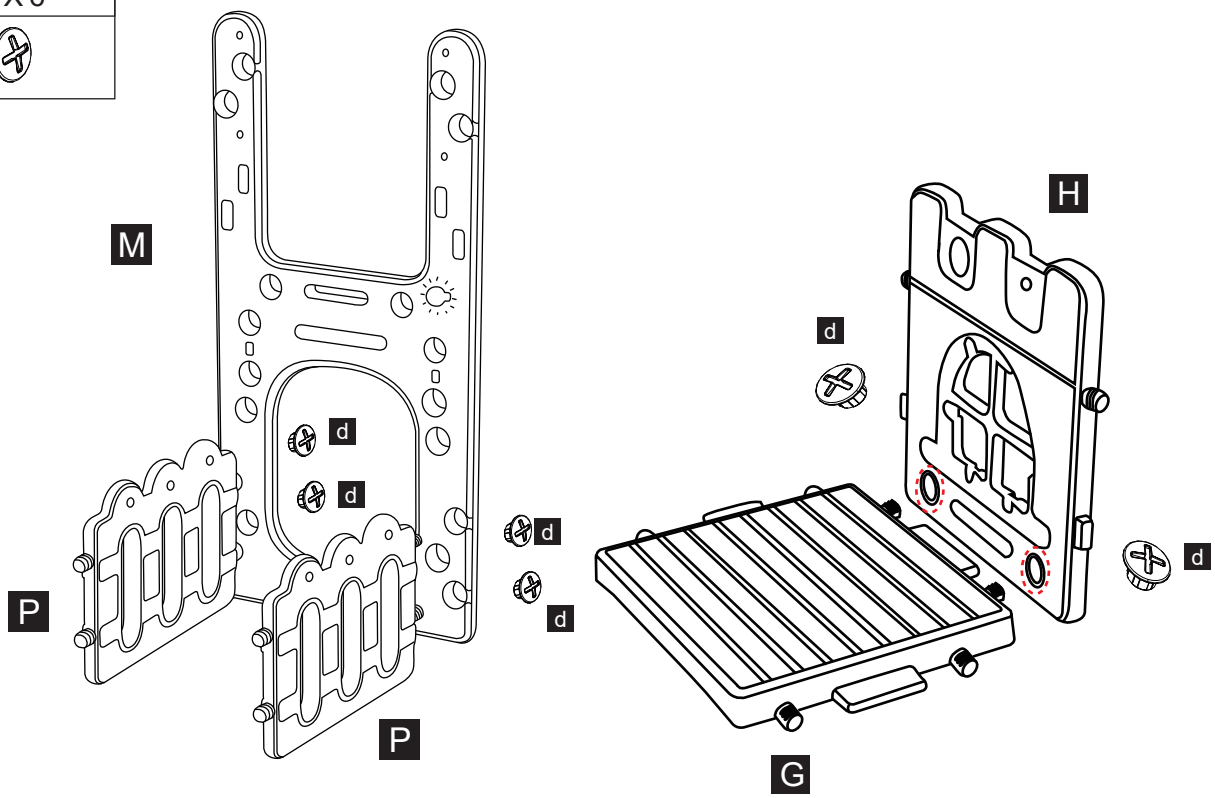

d X 6



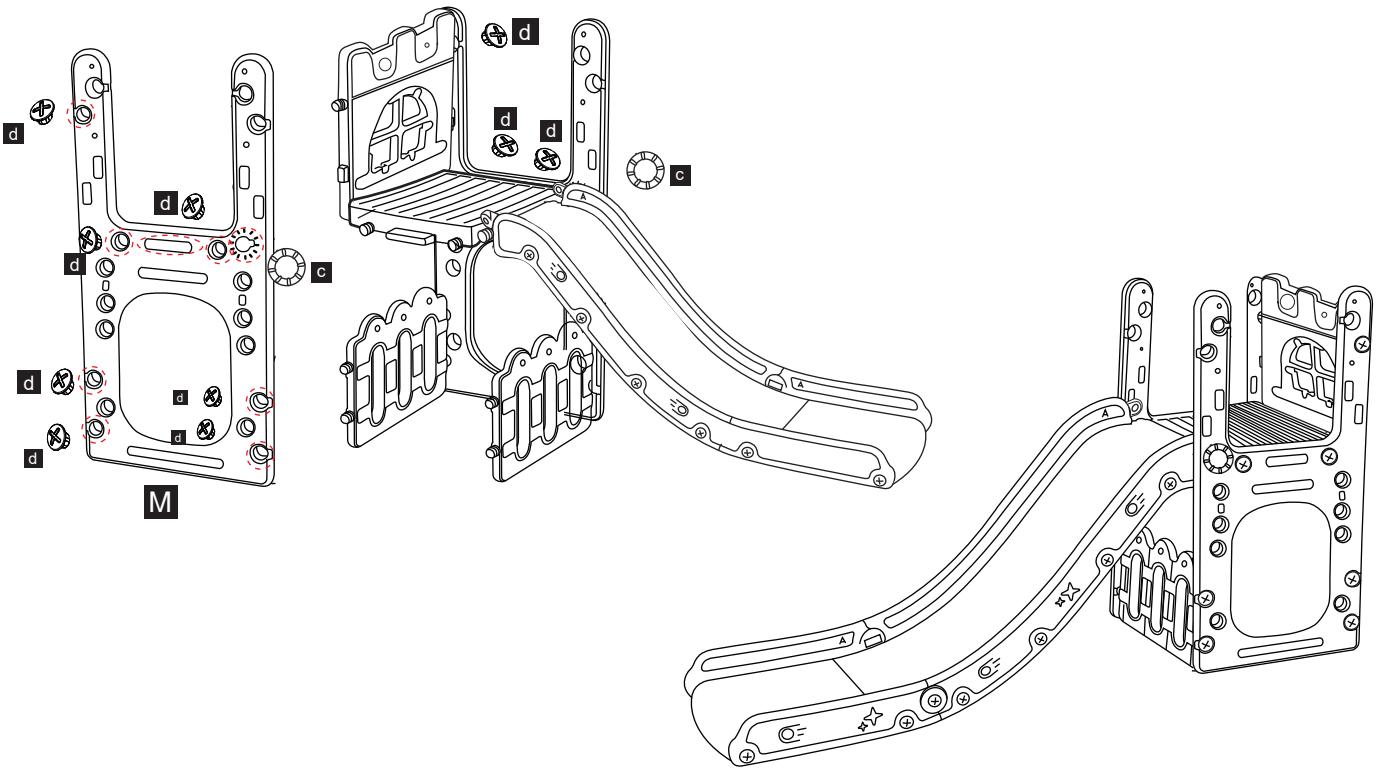



d X 10	c X 2
	

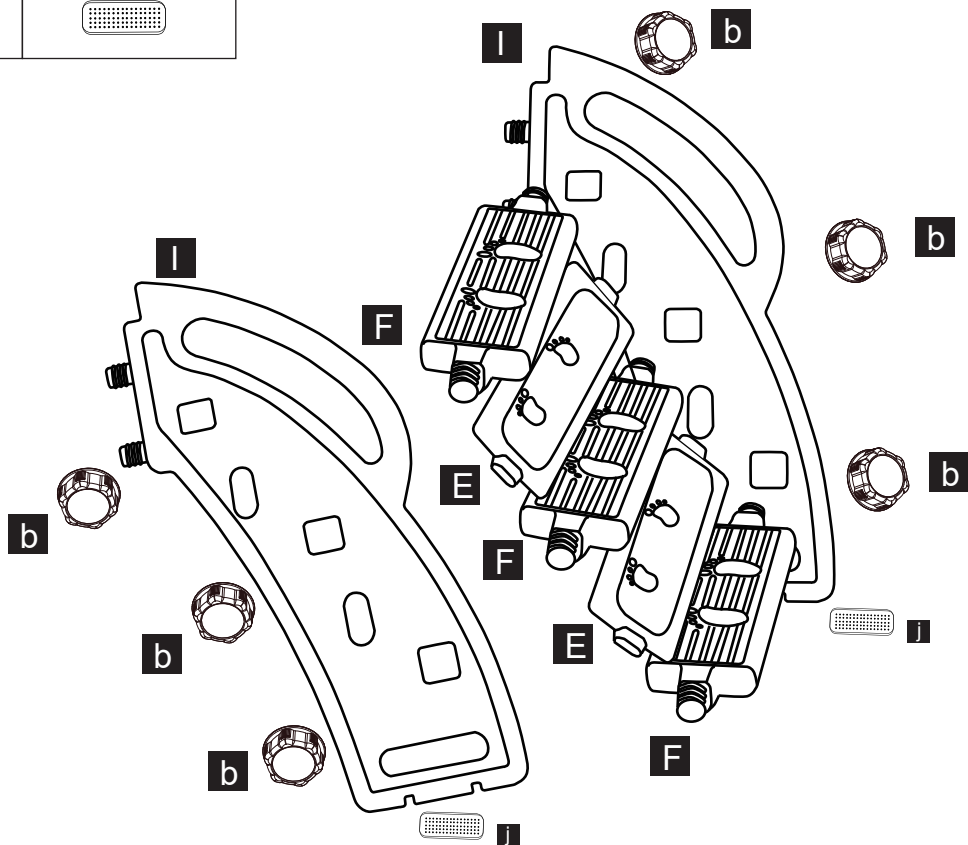

b X6	j X2
	



d X10	a X1	r X1
		

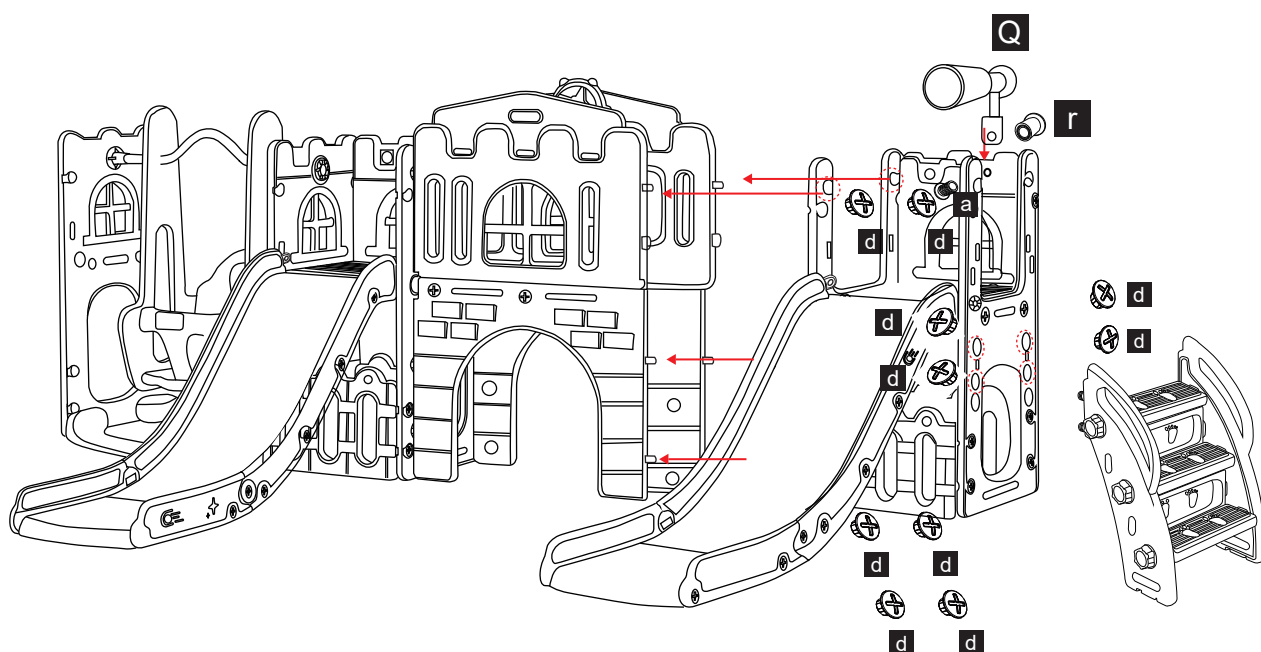

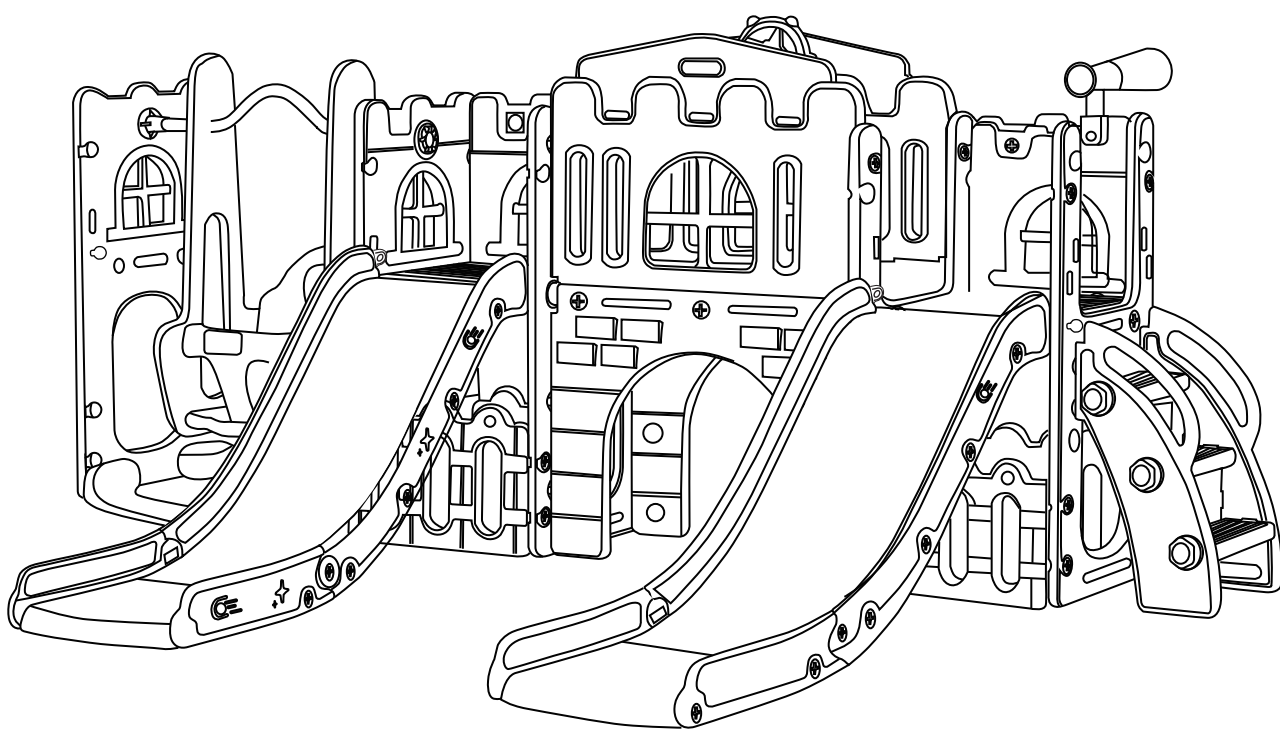

UK

If you have any questions, please contact our customer care center.

Our contact details are below:



0044-800-240-4004



enquiries@mhstar.co.uk

IMPORTER ADDRESS:

MH STAR UK LTD

Unit 27, Perivale Park,
Horsenden lane South

Perivale, UB6 7RH

MADE IN CHINA

ES

Si tiene alguna pregunta, comuníquese con nuestro Centro de Atención al Cliente. Nuestros datos de contacto son los siguientes:



0034-931294512



atencioncliente@aosom.es

IMPORTADOR:

SPANISH AOSOM, S.L.

C/ ROC GROS, N° 15. 08550, ELS HOSTALETES DE
BALENYÀ, SPAIN.

B66295775

WWW.AOSOM.ES

ATENCIONCLIENTE@AOSOM.ES

TEL: 931294512

HECHO EN CHINA

FR

Si vous avez la moindre question, veuillez contacter notre centre d'assistance à la clientèle.

Nos coordonnées sont les suivantes:



0033-1-84166106



aosom@mhfrance.fr

Importé par:

MH France

2, rue Maurice Hartmann

92130 Issy-les-Moulineaux

France

Fabriqué en Chine

PT

Se tiver alguma dúvida, por favor contacte o nosso Centro de Atendimento ao Cliente. Os nossos dados de contacto são os seguintes:



0034-931294512



info@aosom.pt.

IMPORTADOR:

SPANISH AOSOM, S.L

C.ROC GROS N.15, 08550. ELS HOSTALETES DE BALENYÀ

TEL: 931294512 (SEG-SEX DAS 7:30H ÀS 16:30H)

INFO@AOSOM.PT

WWW.AOSOM.PT

DE

Wenn Sie Fragen haben, wenden Sie sich bitte an unser Kundendienstzentrum.

Unsere Kontaktdaten stehen unten:



0049-0(40)-88307530



service@aosom.de

ADRESSE DES IMPORTEURE:

MH Handel GmbH

Wendenstraße 309

D-20537 Hamburg

Germany

IN CHINA HERGESTELLT

IT

In caso di dubbio, si prega di contattare il nostro centro assistenza clienti. I nostri dettagli di contatto sono di seguito:



0039-0249471447



clienti@aosom.it

IMPORTATO DA:

AOSOM Italy srl

Centro Direzionale Milanofiori

Strada 1 Palazzo F1

20057 Assago (MI)

P.I.: 08567220960

FATTO IN CINA



FR

DONNEZ
OU
RECYCLEZ



ASSOCIATION

OU



LIVRAISON

OU



DÉCHÈTERIE

Adresses sur quefairedemesdechets.fr

Aosom